

INTERNATIONAL BACCALAUREATE

**MATHEMATICS
HIGHER LEVEL
(CORE)**

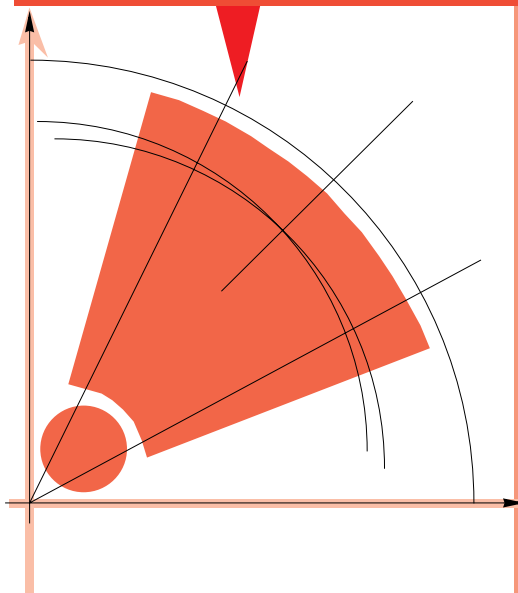

3RD EDITION

3rd imprint

Series editor: **Fabio Cirrito**

Contributing authors:

Nigel Buckle

Iain Dunbar

Copyright ©Nigel Buckle, Iain Dunbar, Key-Strokes Pty Ltd, Mifasa Pty Ltd.

First published in 1997 by IBID Press

2nd Edition published in 1999 by IBID Press,

3rd Edition published in 2004 by IBID Press, 2nd imprint published in 2005

Reprinted 2007



Published by IBID Press, Victoria.

Library Catalogue:

Cirrito Fabio Editor., Buckle & Dunbar

1. Mathematics, 2. International Baccalaureate. Series Title: International Baccalaureate in Detail

ISBN: 1 876659 11 4 (10 digit)

978 1 876659 11 0 (13 digit)

All rights reserved except under the conditions described in the Copyright Act 1968 of Australia and subsequent amendments. No part of this publication may be reproduced, stored in a retrieval system, or transmitted in any form or by any means, without the prior permission of the publishers.

While every care has been taken to trace and acknowledge copyright, the publishers tender their apologies for any accidental infringement where copyright has proved untraceable. They would be pleased to come to a suitable arrangement with the rightful owner in each case.

This book has been developed independently of the International Baccalaureate Organisation (IBO). The text is in no way connected with, or endorsed by, the IBO.

“This publication is independently produced for use by teachers and students. Although references have been reproduced with permission of the VCAA the publication is in no way connected or endorsed by the VCAA.”

We also wish to thank the Incorporated Association of Registered Teachers of Victoria for granting us permission to reproduce questions from their October Examination Papers.

Cover design by Adcore Creative.

Published by IBID Press, at www.ibid.com.au

For further information contact fabio@ibid.com.au

Printed by SHANNON Books, Australia.

PREFACE TO 3RD EDITION

It will be immediately obvious that the 3rd edition of the Mathematics – Higher Level (Core) text has been completely revised and updated. Sections of the previous two editions are still present, but much has happened to improve the text both in content and accuracy.

In response to the many requests and suggestions from teachers worldwide the text was extensively revised. There are more examples for students to refer to when learning the subject matter for the first time or during their revision period. There is an abundance of well-graded exercises for students to hone their skills. Of course, it is not expected that any one student work through every question in this text - such a task would be quite a feat. It is hoped then that teachers will guide the students as to which questions to attempt. The questions serve to develop routine skills, reinforce concepts introduced in the topic and develop skills in making appropriate use of the graphics calculator.

The text has been written in a conversational style so that students will find that they are not simply making reference to an encyclopedia filled with mathematical facts, but rather find that they are in some way participating in or listening in on a discussion of the subject matter.

Throughout the text the subject matter is presented using graphical, numerical, algebraic and verbal means whenever appropriate. Classical approaches have been judiciously combined with modern approaches reflecting new technology - in particular the use of the graphics calculator.

The book has been specifically written to meet the demands of the Higher Level (Core) section of the course and has been pitched at a level that is appropriate for students studying this subject. The book presents an extensive coverage of the syllabus and in some areas goes beyond what is required of the student. Again, this is for the teacher to decide how best to use these sections.

Sets of revision exercises are included in the text. Many of the questions in these sets have been aimed at a level that is on par with what a student could expect on an examination paper. However, some of the questions do go beyond the level that students may expect to find on an examination paper. Success in examinations will depend on an individual's preparation and they will find that making use of a selection of questions from a number of sources will be very beneficial.

I hope that most of the suggestions and recommendations that were brought forward have been addressed in this edition. However, there is always room for improvement. As always, I welcome and encourage teachers and students to contact me with feedback, not only on their likes and dislikes but suggestions on how the book can be improved as well as where errors and misprints occur. There will be updates on the IBID Press website in relation to errors that have been located in the book – so we suggest that you visit the IBID website at www.ibid.com.au. If you believe you have located an error or misprint please email me at fabio@ibid.com.au.

Fabio Cirrito, July 2004

PREFACE TO 2ND EDITION

We are grateful to all those teachers who have made comments and corrections on the first edition. We hope that these contributions have improved this second edition. This edition is now in line with the course whose first examinations will start in 2000. As always, we welcome all comments from teachers and with due time, will make use of them to further improve this book. Suggestions and comments can be directed to Fabio Cirrito via email: fabio@ibid.com.au

Fabio Cirrito, 1999

PREFACE TO 1ST EDITION

This text has been produced independently as a resource to support the teaching of the Mathematics Higher Level Course of the International Baccalaureate. The examples and questions do not necessarily reflect the views of the official senior examining team appointed by the International Baccalaureate Organisation.

The **notation** used is, as far as possible, that specified in the appropriate syllabus guidelines of the IB.

The **units** of physical measurements are in S.I.

The **language** and **spelling** are U.K. English.

Currency quantities are specified in dollars, though these could be read as any currency that is decimalised, such as Swiss francs, Lire etc.

The graphic calculators covered directly in the text are the Texas TI/82 and 83. Supplementary material is available from the publisher for students using some other makes and models of calculators. As it is important that students learn to interpret graphic calculator output, the text and answers present a mixture of graphic calculator screens and conventional diagrams when discussing graphs.

The text has been presented in the order in which the topics appear in the syllabus. This does not mean that the topics have to be treated in this order, though it is generally the case that the more fundamental topics appear at the front of the book. Students are reminded that it is the IB Syllabus that specifies the contents of the course and not this text. One of the keys to success in this course is to be thoroughly familiar with the course contents and the styles of questions that have been used in past examinations.

Fabio Cirrito, August 1997.

CONTENTS

1	THEORY OF KNOWLEDGE	1
1.1	Pure and Applied Mathematics	1
1.2	Axioms	2
1.3	Proof	4
1.3.1	Rules of Inference	5
1.3.2	Proof by Exhaustion	6
1.3.3	Direct Proof	7
1.3.4	Proof by Contradiction	8
1.4	Paradox	10
1.4.1	What is a Paradox?	10
1.4.2	Russell's Paradox?	11
1.5	Mathematics and Other Disciplines	12
1.6	The Extended Essay	15
2	ALGEBRA OF LINEAR AND QUADRATIC EXPRESSIONS	17
2.1	The Real Number Line	17
2.1.1	The Real Number Line	17
2.1.2	Set Builder Notation	17
2.1.3	Interval Notation	17
2.1.4	Number Systems	19
2.1.5	Irrational Numbers	20
2.1.6	The Absolute Value	22
2.2	Linear Algebra	24
2.2.1	Review of Linear Equations	24
2.2.2	Linear Inequations	29
2.3	Linear Functions	33
2.3.1	Graph of the Linear Function	33
2.3.2	Simultaneous Linear Equations in Two Unknowns	37
2.3.3	Simultaneous Linear Equations in Three Unknowns	42
2.4	Quadratics	45
2.4.1	Quadratic Equation	45
2.4.2	Quadratic Function	51
2.4.3	Quadratic Inequalities	58
2.4.4	Simultaneous Equations Involving Linear-Quadratic Equations	62
3	POLYNOMIALS	67
3.1	Algebra of Polynomials	67
3.1.1	Definition	67
3.1.2	Addition and Multiplication of Polynomials	67
3.1.3	Division of Polynomials	68
3.2	Synthetic Division	72
3.3	The Remainder Theorem	75
3.4	The Factor Theorem	77
3.5	Equations and Inequations	83
3.5.1	Polynomial Equations	83
3.5.2	Polynomial Inequations	86
3.6	Sketching Polynomials	88
3.6.1	Graphical Significance of Roots	88
3.6.2	Cubic Functions	89

4	THE BINOMIAL THEOREM	95
4.1	The Binomial Theorem	95
4.1.1	The Binomial Theorem	95
4.1.2	The General term	100
4.2	Proof	104
5	FUNCTIONS AND RELATIONS	105
5.1	Relations	105
5.1.1	Relations	105
5.1.2	The Cartesian Plane	107
5.1.3	Implied Domain	108
5.1.4	Types of Relations	109
5.1.5	Sketching with the Graphics Calculator	110
5.2	Functions	115
5.2.1	Definitions	115
5.3	Some Standard Functions	122
5.3.1	Hybrid Functions and Continuity	122
5.3.2	The Absolute Value Function	126
5.3.3	The Exponential Function	131
5.3.4	The Logarithmic Function	138
5.3.5	Equations of the Form $y = x^n, n = -1, -2$	144
5.4	Algebra of Functions	148
5.4.1	Basic Operations and Composite Functions	148
5.4.2	Identity and Inverse Functions	157
6	TRANSFORMATIONS OF GRAPHS	167
6.1	Translations	167
6.1.1	Horizontal Translation	167
6.1.2	Vertical Translation	170
6.2	Dilations	177
6.2.1	Dilation from the x -axis	177
6.2.2	Dilation from the y -axis	179
6.3	Reflections	183
6.4	Reciprocal of a Function	188
7	EXPONENTIAL AND LOGARITHMIC FUNCTIONS	197
7.1	Exponents	197
7.1.1	Basic Rules of Indices	197
7.1.2	Indicial Equations	201
7.1.3	Equations of the form $b^{f(x)} = b^{g(x)}$	203
7.1.4	What if the Base is Not The Same?	205
7.1.5	A Special Base (e)	207
7.2	Exponential Modelling	209
7.3	Logarithms	217
7.3.1	What are Logarithms	217
7.3.2	Can we find the Logarithm of a Negative Number?	219
7.4	The Algebra of Logarithms	221
7.5	Logarithmic Modelling	230
REVISION SET A – PAPER 1 AND PAPER 2 STYLE QUESTIONS		233

8	SEQUENCES AND SERIES	241
8.1	Arithmetic Sequences and Series	241
8.1.1	Arithmetic Sequences	241
8.1.2	Arithmetic Series	245
8.1.3	Sigma Notation	249
8.2	Geometric Sequences and Series	252
8.2.1	Geometric Sequences	252
8.2.2	Geometric Series	257
8.2.3	Combined A.Ps and G.Ps	261
8.2.4	Convergent Series	263
8.3	Compound Interest and Superannuation	267
8.3.1	Compound Interest	267
8.3.2	Superannuation	268
9	MENSURATION	273
9.1	Trigonometric Ratios	273
9.1.1	Review of Trigonometric Functions for Right-angled Triangles	273
9.1.2	Exact Values	273
9.2	Applications	278
9.2.1	Angle of Elevation and Depression	278
9.2.2	Bearings	280
9.3	Right Angles in 3-Dimensions	283
9.4	Area of a Triangle	287
9.5	Non Right-Angled Triangles	290
9.5.1	The Sine Rule	290
9.5.2	The Ambiguous Case	294
9.5.3	Applications of The Sine Rule	298
9.5.4	The Cosine Rule	300
9.5.5	Applications of The Cosine Rule	302
9.6	More Applications in 3-D	307
9.7	Arc, Sectors and Segments	309
9.7.1	Radian Measure of an Angle	309
9.7.2	Arc Length	310
9.7.3	Area of Sector	311
10	CIRCULAR TRIGONOMETRIC FUNCTIONS	315
10.1	Trigonometric Ratios	315
10.1.1	The Unit Circle	315
10.1.2	Angle of Any Magnitude	316
10.2	Trigonometric Identities	328
10.2.1	The Fundamental Identity	328
10.2.2	Compound Angle Identities	333
10.3	Trigonometric Functions	344
10.3.1	The Sine, Cosine and Tangent Functions	344
10.3.2	Transformations of Trigonometric Functions	347
10.4	Inverse Trigonometric Functions	357
10.4.1	The Inverse Sine Function	357
10.4.2	The Inverse Cosine Function	359
10.4.3	The Inverse Tangent Function	361
10.5	Trigonometric Equations	366
10.5.1	Solution to $\sin x = a$, $\cos x = a$ and $\tan x = a$	366
10.6	Applications	377

11	COMPLEX NUMBERS	383
11.1	Complex Numbers	383
11.1.1	Introduction	383
11.1.2	Notations and $i^2 = -1$	383
11.1.3	Using the TI-83 with Complex Numbers	384
11.1.4	The Algebra of Complex Numbers	385
11.2	Geometrical Representation of Complex Numbers	392
11.2.1	The Argand Diagram	392
11.2.2	Geometrical Properties of Complex Numbers	393
11.3	Polar Form of Complex Numbers	402
11.4	Polynomials over the Complex Field	413
11.4.1	Quadratic Equations	413
11.4.2	Polynomial Equations (of order ≥ 3)	414
11.4.3	Solutions to Equations of the Form $z^n = x + iy$	419
11.5	Miscellaneous Proofs	425
11.5.1	The Triangle Inequality	425
11.5.2	De Moivre's Theorem	425
11.5.3	Fundamental Theorem of Algebra	426
11.5.4	Conjugate Root Theorem	426
12	MATHEMATICAL INDUCTION	427
12.1	Mathematical Induction	427
12.1.1	The Principles of Mathematical Induction and Proofs	427
12.2	Further Examples Part 1	431
12.3	Further Examples Part 2	433
12.4	Forming Conjectures	436
12.4.1	The n th Term of a Sequence	436
12.4.2	The Sum to n Terms of a Sequence	440
REVISION SET B – PAPER 1 AND PAPER 2 STYLE QUESTIONS		445
13	STATISTICS	455
13.1	Describing Data	455
13.1.1	Data Collection	455
13.1.2	Types of Data	
13.1.3	Discrete and Continuous Data	456
13.2	Frequency Diagrams	457
13.2.1	Producing a Frequency Diagram	457
13.2.2	Using a Graphics Calculator	458
13.3	Statistical Measures 1	460
13.3.1	Measure of Central Tendency	460
13.3.2	Mode	460
13.3.3	Mean	460
13.3.4	Median	462
13.4	Statistical Measures 2	463
13.4.1	Measures of Spread	463
13.4.2	Variance and Standard Deviation	464
13.4.3	Using a Graphics Calculator	466
13.5	Statistical Measures 3	468
13.5.1	Quartiles	468
13.5.2	Box Plot	470

14	COUNTING PRINCIPLES	477
14.1	Multiplication Principle	477
14.1.1	Definition	477
14.1.2	Multiplication Principle	477
14.1.3	Permutations	479
14.2	Combinations	484
15	PROBABILITY	489
15.1	Probability	489
15.1.1	Probability as a Long-Term Relative Frequency	489
15.1.2	Theoretical Probability	489
15.1.3	Laws of Probability	490
15.1.4	Definition of Probability	490
15.1.5	Problem Solving Strategies in Probability	492
15.2	Probability & Venn Diagrams	494
15.3	Conditional Probability	498
15.3.1	Informal Definition of Conditional Probability	498
15.3.2	Formal Definition of Conditional Probability	498
15.3.3	Independence	500
15.4	Bayes' Theorem	505
15.4.1	Law of Total Probability	505
15.4.2	Bayes' Theorem for Two Elements	506
15.5	Using Permutations and Combinations in Probability	510
16	DISCRETE RANDOM VARIABLES	513
16.1	Discrete Random Variables	513
16.1.1	Concept of a Random Variable	513
16.1.2	Discrete Random Variable	513
16.1.3	Probability Distributions	514
16.1.4	Properties of The Probability Function	515
16.1.5	Constructing Probability Functions	517
16.2	Mean and Variance	521
16.2.1	Central Tendency and Expectation	521
16.2.2	So, what exactly does $E(X)$ measure?	521
16.2.3	Properties of The Expectation (Function)	523
16.2.4	Variance	525
16.2.5	Properties of The Variance	526
16.3	The Binomial Distribution	530
16.3.1	The Binomial Experiment	530
16.3.2	Bernoulli Trials	530
16.3.3	Properties of The Binomial Experiment	530
16.3.4	Binomial Distribution	530
16.3.5	Expectation, Mode and Variance for the Binomial Distribution	533
16.4	Hypergeometric Distribution	539
16.4.1	Hypergeometric Distribution Function	539
16.4.2	Mean and Variance of The Hypergeometric Distribution	541
16.5	Poisson Distribution	545
16.5.1	Poisson Distribution Function	545
16.5.2	Poisson Recurrence Formula	548
16.5.3	Mean and Variance of The Poisson Distribution	549
16.5.4	Poisson as a Limit of Binomial	551

17	THE NORMAL DISTRIBUTION	555
17.1	The Normal Distribution	555
17.1.1	Why The Normal Distribution?	555
17.1.2	The Standard Normal Curve	555
17.1.3	Using The Standard Normal Table	556
17.2	Formalising The Definition of The Normal Distribution	559
17.2.1	The Normal Distribution	559
17.2.2	Properties of This Curve	560
17.2.3	Finding Probabilities Using The Normal Distribution	560
17.2.4	The Standard Normal Distribution	560
17.2.5	Finding Probabilities	561
17.2.6	Standardising any Normal Distribution	562
17.2.7	Inverse Problems	566
17.2.8	Finding Quantiles	568
REVISION SET C – PAPER 1 AND PAPER 2 STYLE QUESTIONS		575
18	RATES OF CHANGE	585
18.1	Quantitative Measure	585
18.1.1	Functional Dependence	585
18.1.2	Quantitative Aspects of Change	586
18.1.3	Average Rate of Change	586
18.1.4	Determining the Average Rate of Change	587
18.1.5	Velocity as a Measure of Rate of Change of Displacement	588
18.2	Qualitative Measure	592
18.2.1	Qualitative Aspects of Change	592
18.2.2	Describing the Behaviour of a Graph	592
18.2.3	Producing a Graph from a Physical Situation	592
18.3	Instantaneous Rate of Change	595
18.3.1	Informal Idea of Limits	595
18.4	Differentiation Process	601
18.4.1	The Derivative and The Gradient Function	601
18.4.2	Notation and Language	602
19	DIFFERENTIAL CALCULUS	605
19.1	Differentiation	605
19.1.1	Review	605
19.1.2	Power Rule for Differentiation	608
19.1.3	Derivative of a Sum or Difference	610
19.2	Graphical Interpretation of The Derivative	613
19.2.1	The Value of The Derivative at a Particular Point on a Curve	613
19.2.2	Gradient Function from a Graph	618
19.2.3	Differentiating with Variables other than x and y	621
19.3	Derivative of Transcendental Functions	622
19.3.1	Derivative of Circular Trigonometric Functions	622
19.3.2	Derivative of The Exponential Functions	623
19.3.3	Derivative of The Natural Log Functions	624
19.3.4	Derivative of a Product of Functions	624
19.3.5	Derivative of a Quotient of Functions	626
19.3.6	The Chain Rule	627
19.3.7	Derivative of Reciprocal Circular Functions	634
19.4	Derivative of Inverse Trigonometric Functions	639

19.4.1	Derivative of $\text{Sin}^{-1}(x)$	639
19.4.2	Derivative of $\text{Cos}^{-1}(x)$	640
19.4.3	Derivative of $\text{Tan}^{-1}(x)$	641
19.4.4	Generalisations for The Derivative of The Inverse Circular Functions	641
19.5	Derivative of a^x and $\log_a x$	644
19.5.1	Differentiating $y = a^x$	644
19.5.2	Differentiating $y = \log_a x$	646
19.5.3	Generalisation of Exponential and Logarithmic Derivatives	647
19.6	Second Derivative	650
19.7	Implicit Differentiation	652
19.7.1	Implicit Relations	652
19.7.2	Second Derivative	658
19.8	Proofs	660
19.8.1	Derivative of $y = x^n$ where n is a Negative Integer	660
19.8.2	Derivative of $y = x^n$ where n is a Fraction	660
19.8.3	Product Rule and Quotient Rule	661
19.8.4	Derivative of Some Trigonometric Functions	661
19.8.5	Exponential and $y = x^n$ where n is Real	664
20	DIFFERENTIAL CALCULUS AND CURVE SKETCHING	665
20.1	Tangents and Normals	665
20.1.1	Equation of Tangent	665
20.1.2	Equation of Normal	667
20.2	Curve Sketching	671
20.2.1	Increasing and Decreasing Functions	671
20.2.2	Stationary Points	673
20.2.3	Global Maxima and Minima	684
20.2.4	Vertical Tangents and Cusps	688
20.2.5	Summary	690
20.3	The Second Derivative and its Application	695
20.3.1	Definition	695
20.4	Rational Functions	702
20.4.1	Sketching the Graph of $x \mapsto \frac{ax+b}{cx+d}$, $cx+d \neq 0$	702
20.4.2	Other Rational Functions	704
20.4.3	Oblique and Curved Asymptotes	706
21	APPLICATIONS OF DIFFERENTIAL CALCULUS	711
21.1	Rates Of Change	711
21.1.1	Definitions	711
21.1.2	Rates of Change and Their Sign	712
21.2	Applied Rates of Change	713
	Application to Economics	714
	Application to Kinematics	715
21.3	Kinematics	718
20.3.1	Motion Along a Straight Line	718
21.4	Related Rates	727
21.5	Applied Maxima and Minima Problems	741
21.5.1	Maxima–Minima Problems	741

MATHEMATICS – Higher Level (Core)

21.5.2	End point Maxima/Minima Problems	752
21.5.3	Optimisation for Integer Valued Variables	754

REVISION SET D – PAPER 1 AND PAPER 2 STYLE QUESTIONS 763

22 INTEGRATION AND ITS APPLICATIONS 773

22.1	Integration	773
22.1.1	Antidifferentiation & The Indefinite Integral	773
22.1.2	Language and Notation	773
22.1.3	Determining The Indefinite Integral	774
22.1.4	Properties of The Indefinite Integral	776
22.2	Solving for ‘c’	778
22.3	Standard Integrals	781
22.4	The Definite Integral	790
22.4.1	Why The Definite Integral?	790
22.4.2	Language and Notation	790
22.4.3	Properties of The Definite Integral	793
22.5	Applications of Integration	798
22.5.1	Introduction to the Area Beneath a Curve	798
22.5.2	In Search of a Better Approximation	799
22.5.3	Towards an Exact Value	800
22.5.4	The Definite Integral and Areas	801
22.5.5	Further Observation about Areas	802
22.5.6	The Signed Areas	803
22.5.7	Steps for Finding Areas	804
22.5.8	Area Between Two Curves	805
22.6	Applications to Kinematics	812
22.7	Applications to Probability	816
22.7.1	Continuous Random Variables	816
22.7.2	Mode, Mean, Median and Variance	820
22.8	Volumes (Solid of Revolution)	826

23 FURTHER INTEGRATION 833

23.1	Integration by Substitution	833
23.1.1	Indefinite Integrals	833
23.1.2	Substitution Rule	841
23.2	Integration by Parts	848
23.2.1	The Basics	848
23.2.2	Repeated Integration by Parts	850
23.3	Applications	852

24 DIFFERENTIAL EQUATIONS 853

24.1	Differential Equations	853
24.1.1	What are Differential Equations?	853
24.1.2	Verifying a Solution	854
24.2	Solving Differential Equations	857
24.3	Applications	866

25 MATRICES 875

25.1	Introduction to Matrices	875
25.1.1	Definitions	875
25.1.2	Matrix Multiplication	881

25.2	Inverses and Determinants	888
25.2.1	Inverse and Determinant of 2 by 2 Matrices	888
25.2.2	Inverse and Determinant of 3 by 3 Matrices	891
25.3	Simultaneous Equations	900
26	VECTORS	909
26.1	Introduction to Vectors	909
26.1.1	Scalar and Vector Quantities	909
26.2	Representing Vectors	910
26.2.1	Directed Line Segment	910
26.2.2	Magnitude of a Vector	910
26.2.3	Equal Vectors	910
26.2.4	Negative Vectors	911
26.2.5	Zero Vector	911
26.2.6	Orientation and Vectors	911
26.3	Algebra and Geometry of Vectors	915
26.3.1	Addition of Vectors	915
26.3.2	Subtraction of Vectors	916
26.3.3	Multiplication of Vectors by Scalars	916
26.3.4	Angle Between Vectors	917
26.3.5	Applications to Geometry	917
26.4	Cartesian Representation of Vectors in 2-D and 3-D	923
26.4.1	Representation in 2-D	923
26.4.2	Unit Vector and Base Vector Notation	923
26.4.3	Representation in 3-D	924
26.4.4	Vector Operations	925
26.5	Further Properties of Vectors in 2-D and 3-D	929
26.5.1	Magnitude of a Vector	929
26.5.2	Unit Vectors	930
26.6	Scalar Product of 2 Vectors	932
26.6.1	Definition of the Scalar Product	932
26.6.2	Properties of the Scalar Product	934
26.6.3	Special Cases of the Scalar Product	935
26.6.4	Direction Cosine	938
26.6.5	Using a Graphics Calculator	943
26.7	Vector Equation of a Line	944
26.7.1	Vector Equation of a Line in 2-D	944
26.7.2	Lines in Three Dimensions	952
27	3-D GEOMETRY	961
27.1	Vector Product	961
27.1.1	Vector Product	961
27.1.2	Vector Form of the Vector Product	964
27.1.3	Applications of the Vector Product	968
27.2	Planes in 3-Dimensions	972
27.2.1	Vector Equation of a Plane	972
27.2.2	Cartesian Equation of a Plane	973
27.2.3	Normal Vector Form of a Plane	975
27.2.4	The Normal Form	979
27.3	Intersecting Lines and Planes	982
27.3.1	Intersection of Two Lines	982
27.3.2	Intersection of a Line and a Plane	983

MATHEMATICS – Higher Level (Core)

27.3.3	Intersection of Two Planes	985
27.3.4	Intersection of Three Planes	986

REVISION SET E – PAPER 1 AND PAPER 2 STYLE QUESTIONS 991

ANSWERS 1001

NOTATION

The list below represents the signs and symbols which are recommended by the International Organization for Standardization as well as other symbols that are used in the text.

\mathbb{N}	the set of positive integers and zero, $\{0, 1, 2, 3, \dots\}$
\mathbb{Z}	the set of integers, $\{0, \pm 1, \pm 2, \pm 3, \dots\}$
\mathbb{Z}^+	the set of positive integers, $\{1, 2, 3, \dots\}$
\mathbb{Q}	the set of rational numbers $\left\{x \mid x = \frac{a}{b}, b \neq 0, a, b \in \mathbb{Z}\right\}$
\mathbb{Q}^+	the set of positive rational numbers, $\{x \mid x \in \mathbb{Q}, x > 0\}$
\mathbb{R}	the set of real numbers
\mathbb{R}^+	the set of positive real numbers $\{x \mid x \in \mathbb{R}, x > 0\}$
\mathbb{C}	the set of complex numbers, $\{a + bi \mid a, b \in \mathbb{R}\}$
z	a complex number
z^*	the complex conjugate of z
$ z $	the modulus of z
$\arg z$	the argument of z
$\operatorname{Re} z$	the real part of z
$\operatorname{Im} z$	the imaginary part of z
$\{x_1, x_2, \dots\}$	the set with elements x_1, x_2, \dots
$n(A)$	the number of elements in the finite set A
$\{x \mid \}$	the set of all x such that...
\in	is an element of
\notin	is not an element of
\emptyset	the empty (null) set
U	the universal set
\cup	union
\cap	intersection
\subset	is a proper subset of
\subseteq	is a proper subset of
A'	the complement of set A
$A \times B$	the Cartesian product of sets A & B , $(A \times B = \{(a, b) \mid a \in A, b \in B\})$
$a \mid b$	a divides b
$a^{1/n}, \sqrt[n]{a}$	a to the power $\frac{1}{n}$ or the n th root of a

MATHEMATICS – Higher Level (Core)

$a^{1/2}, \sqrt{a}$ a to the power $\frac{1}{2}$ or the square root of $a \geq 0$

$|x|$ the modulus or absolute value of x $\begin{cases} x, & x \geq 0 \\ -x, & x < 0 \end{cases}$

\equiv identity

\approx is approximately equal to

$>$ is greater than

\geq is greater than or equal to

$<$ is less than

\leq is less than or equal to

\nlessgtr is not greater than

\nlessgtr is not less than

$[a, b]$ the closed interval $a \leq x \leq b$

$]a, b[$ the open interval $a < x < b$

u_n the n th term of a sequence or series

d the common difference of an arithmetic sequence

r the common ratio of a geometric sequence

S_n the sum of the first n terms of a sequence $u_1 + u_2 + u_3 + \dots + u_n$

S_∞ the sum to infinity of a sequence $u_1 + u_2 + u_3 + \dots$

$\sum_{i=1}^n u_i$ $u_1 + u_2 + \dots + u_n$

$\prod_{i=1}^n u_i$ $u_1 \times u_2 \times \dots \times u_n$

$\binom{n}{r}$ $\frac{n!}{r!(n-r)!}$

$f: A \rightarrow B$ f is a function under which each element of set A has an image in set B

$f: x \mapsto y$ f is a function under which x is mapped to y

$f(x)$ the image of x under the function f

$f^{-1}(x)$ the inverse function of the function f

$f \circ g$ the composite function of f and g

$\lim_{x \rightarrow a} f(x)$ the limit of $f(x)$ as x tends to a

$\frac{dy}{dx}$ the derivative of y with respect to x

$f'(x)$ the derivative of $f(x)$ with respect to x

$\frac{d^2y}{dx^2}$	the second derivative of y with respect to x
$f''(x)$	the second derivative of $f(x)$ with respect to x
$\frac{d^n y}{dx^n}$	the n th derivative of y with respect to x
$f^{(n)}(x)$	the n th derivative of $f(x)$ with respect to x
$\int y dx$	the indefinite integral of y with respect to x
$\int_a^b y dx$	the definite integral of y with respect to x between the limits $x = a$ and $x = b$
e^x	the exponential function of x
$\log_a x$	logarithm to the base a of x
$\ln x$	the natural logarithm of x , $\log_e x$
\sin, \cos, \tan	the circular functions
$\left. \begin{array}{l} \arcsin \\ \arccos \\ \arctan \end{array} \right\}$	the inverse circular functions
\csc, \sec, \cot	the reciprocal circular functions
$A(x, y)$	the point A in the plane with Cartesian coordinates x and y
$[AB]$	the line segment with endpoints A and B
AB	the length of $[AB]$
(AB)	the line containing points A and B
\hat{A}	the angle at A
\hat{CAB}	the angle between the lines $[CA]$ and $[AB]$
$\triangle ABC$	the triangle whose vertices are A , B and C
\mathbf{v}	the vector \mathbf{v}
\overrightarrow{AB}	the vector represented in magnitude and direction by the directed line segment from A to B
\mathbf{a}	the position vector \overrightarrow{OA}
$\mathbf{i}, \mathbf{j}, \mathbf{k}$	unit vectors in the directions of the Cartesian coordinate axes
$ \mathbf{a} $	the magnitude of \mathbf{a}
$ \overrightarrow{AB} $	the magnitude of \overrightarrow{AB}
$\mathbf{v} \cdot \mathbf{w}$	the scalar product of \mathbf{v} and \mathbf{w}
$\mathbf{v} \times \mathbf{w}$	the vector product of \mathbf{v} and \mathbf{w}

MATHEMATICS – Higher Level (Core)

A^{-1}	the inverse of the non-singular matrix A
A^T	the transpose of the matrix A
$\det A$	the determinant of the square matrix A
I	the identity matrix
$P(A)$	probability of event A
$P(A')$	probability of the event “not A ”
$P(A B)$	probability of the event A given B
x_1, x_2, \dots	observations
f_1, f_2, \dots	frequencies with which the observations x_1, x_2, \dots occur
P_x	probability distribution function $P(X = x)$ of the discrete random variable X
$f(x)$	probability density function of the continuous random variable X
$F(x)$	cumulative distribution function of the continuous random variable X
$E(x)$	the expected value of the random variable X
$\text{Var}(x)$	the variance of the random variable X
μ	population mean

σ^2 population variance, $\sigma^2 = \frac{\sum_{i=1}^k f_i(x_i - \mu)^2}{n}$ where $n = \sum_{i=1}^k f_i$

σ population standard deviation

\bar{x} sample mean

s_n^2 sample variance, $\sigma^2 = \frac{\sum_{i=1}^k f_i(x_i - \bar{x})^2}{n}$ where $n = \sum_{i=1}^k f_i$

s_n standard deviation of the sample

s_{n-1}^2 unbiased estimate of the population variance $s_{n-1}^2 = \frac{n}{n-1} s_n^2$ or $\frac{\sum_{i=1}^k f_i(x_i - \bar{x})^2}{n-1}$

$B(n, p)$ binomial distribution with parameters n and p

$Po(m)$ Poisson distribution with mean m

$N(\mu, \sigma^2)$ normal distribution with mean μ and variance σ^2

$X \sim B(n, p)$ the random variable X has a binomial distribution with parameters n and p

$X \sim Po(m)$ the random variable X has a Poisson distribution with mean m

$X \sim N(\mu, \sigma^2)$ the random variable X has a normal distribution with mean μ and variance σ^2

Φ cumulative distribution function of the standardised normal variable: $N(0, 1)$

v	number of degrees of freedom
χ^2	the chi-squared distribution
χ_{calc}^2	the chi-squared test statistic, where $\chi_{calc}^2 = \sum \frac{(f_o - f_e)^2}{f_e}$
$A \setminus B$	the difference of the sets A and B ($A \setminus B = A \cap B' = \{x x \in A \text{ and } x \notin B\}$)
$A \Delta B$	the symmetric difference of the sets A and B ($A \Delta B = (A \setminus B) \cup (B \setminus A)$)
κ_n	a complete graph with n vertices
$\kappa_{n,m}$	a complete bipartite graph with n vertices and another set of m vertices
\mathbb{Z}_p	the set of equivalence classes $\{0,1,2,\dots,p-1\}$ of integers modulo p
$\gcd(a,b)$	the greatest common divisor of the integers a and b
$\text{lcm}(a,b)$	the least common multiple of the integers a and b
A_G	the adjacency matrix of graph G
C_G	the cost adjacency matrix of graph G

1.1

PURE AND APPLIED MATHEMATICS

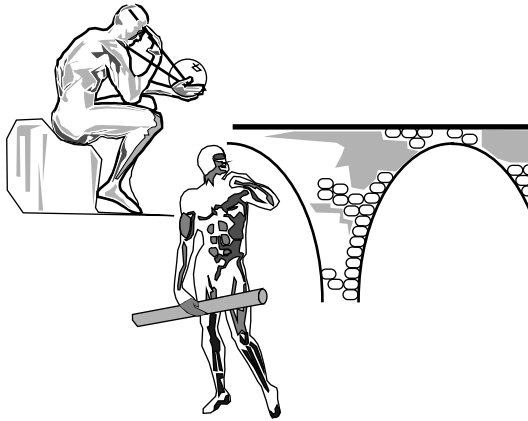

Mathematics has clearly played a significant part in the development of many past and present civilisations.

There is good evidence that mathematical, and probably astronomical techniques, were used to build the many stone circles of Europe which are thought to be at least three thousand years old (Thom). It is likely that the Egyptian pyramids and constructions on Aztec and Mayan sites in South America were also built by mathematically sophisticated architects. Similarly, cultures in China, India and throughout the Middle

East developed mathematics a very long time ago. It is also the case that there have been very successful cultures that have found little use for mathematics. Ancient Rome, handicapped, as it was, by a non-place value number system did not develop a mathematical tradition at anything like the same level as that of Ancient Greece. Also, the Australian Aborigines who have one of the most long lasting and successful cultures in human history did not find much need for mathematical methods. The same is true of the many aboriginal cultures of Africa, Asia and the Americas. This may well be because these aboriginal cultures did not value ownership in the way that western culture does and had no need to count their possessions. Instead, to aboriginal cultures, a responsible and sustainable relationship with the environment is more important than acquisition and exploitation. Maybe we should learn from this before it is too late!

Mathematics has developed two distinct branches. Pure mathematics, which is studied for its own sake, and applied mathematics which is studied for its usefulness. This is not to say that the two branches have not cross-fertilised each other, for there have been many examples in which they have.

The pure mathematician Pierre de Fermat (1601-1665) guessed that the equation $x^n + y^n = z^n$ has whole numbered solutions for $n = 2$ only. To the pure mathematician, this type of problem is interesting for its own sake. To study it is to look for an essential truth, the ‘majestic clockwork’ of the universe. Pure mathematicians see ‘beauty’ and ‘elegance’ in a neat proof. To pure mathematicians, their subject is an art.

Applied mathematics seeks to develop mathematical objects such as equations and computer algorithms that can be used to predict what will happen if we follow a particular course of action. This is a very valuable capability. We no longer build bridges without making careful calculations as to whether or not they will stand. Airline pilots are able to experience serious failures in commercial jets without either risking lives or the airline’s valuable aeroplanes or, indeed, without even leaving the ground.

1.2 AXIOMS

Mathematics is based on axioms. These are ‘facts’ that are assumed to be true. An axiom is a statement that is accepted without proof. Early sets of axioms contained statements that appeared to be obviously true. Euclid postulated a number of these ‘obvious’ axioms.

Example:

‘Things equal to the same thing are equal to each other’;

That is, if $y = a$ and $x = a$ then $y = x$.

Euclid was mainly interested in geometry and we still call plane geometry ‘Euclidean’. In Euclidean space, the shortest distance between two points is a straight line. We will see later that it is possible to develop a useful, consistent mathematics that does not accept this axiom.

Most axiom systems have been based on the notion of a ‘set’, meaning a collection of objects. An example of a set axiom is the ‘**axiom of specification**’. In crude terms, this says that if we have a set of objects and are looking at placing some condition or specification on this set, then the set thus specified must exist. We consider some examples of this axiom.

Example:

Assume that the set of citizens of China is defined. If we impose the condition that the members of this set must be female, then this new set (of Chinese females) is defined.

As a more mathematical example, if we assume that the set of whole numbers exists, then the set of even numbers (multiples of 2) must also exist.

A second example of a set axiom is the ‘**axiom of powers**’:

Example:

For each set, there exists a collection of sets that contains amongst its elements all the subsets of the original set. If we look at the set of cats in Bogota, then there must be a set that contains all the female cats in Bogota, another that contains all the cats with green eyes in Bogota, another that contains all the Bogota cats with black tails, etc. A good, but theoretical, account of axiomatic set theory can be found in Halmos, 1960.

Mathematics has, in some sense, been a search for the smallest possible set of consistent axioms. In the section on paradox, we will look further at the notion of axioms and the search for a set of assumptions that does not lead to contradictions. There is a very strong sense in which mathematics is an unusual pursuit in this respect. Pure mathematics is concerned with absolute truth only in the sense of creating a self-consistent structure of thinking.

As an example of some axioms that may not seem to be sensible, consider a geometry in which the shortest path between two points is the arc of a circle and all parallel lines meet. These ‘axioms’ do not seem to make sense in ‘normal’ geometry. The first mathematicians to investigate non-Euclidean geometry were the Russian, Nicolai Lobachevsky (1793-1856) and the Hungarian, Janos Bolyai (1802-1860). Independently, they developed self consistent geometries that did not include the so called parallel postulate which states that for every line AB and point C outside AB there is only one line through C that does not meet AB.

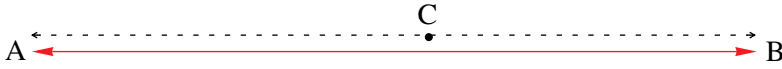

Since both lines extend to infinity in both directions, this seems to be ‘obvious’. Non-Euclidean geometries do not include this postulate and assume either that there are no lines through C that do not meet AB or that there is more than one such line. It was the great achievement of Lobachevsky and Bolyai that they proved that these assumptions lead to geometries that are self consistent and thus acceptable as ‘true’ to pure mathematicians. In case you are thinking that this sort of activity is completely useless, one of the two non-Euclidean geometries discussed above has actually proved to be useful; the geometry of shapes drawn on a sphere. This is useful because it is the geometry used by the navigators of aeroplanes and ships.

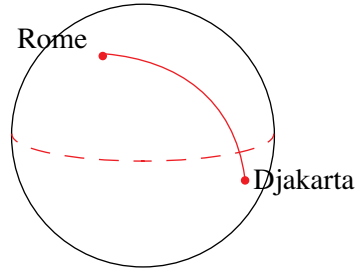

The first point about this geometry is that it is impossible to travel in straight lines. On the surface of a sphere, the shortest distance between two points is an arc of a circle centred at the centre of the sphere (a great circle). The shortest path from Rome to Djakarta is circular. If you want to see this path on a geographer’s globe, take a length of sewing cotton and stretch it tightly between the two cities. The cotton will follow the approximate great circle route between the two cities.

If we now think of the arcs of great circles as our ‘straight lines’, what kind of geometry will we get? You can see some of these results without going into any complex calculations. For example, what would a triangle look like?

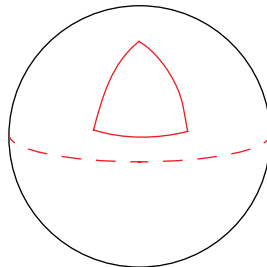

The first point is that the angles of this triangle add up to more than 180° . There are many other ‘odd’ features of this geometry. However, fortunately for the international airline trade, the geometry is self consistent and allows us to navigate safely around the surface of the globe. Thus non-Euclidean geometry is an acceptable pure mathematical structure.

While you are thinking about unusual geometries, what are the main features of the geometry of shapes drawn on the ‘saddle surface’?

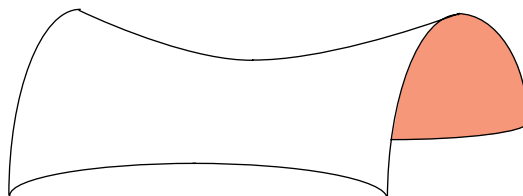

MATHEMATICS – Higher Level (Core)

One final point on the subject of non-Euclidean geometries; it seems to be the case that our three dimensional universe is also curved. This was one of the great insights of Albert Einstein (1879-1955). We do not yet know if our universe is bent back on itself rather like a sphere or whether another model is appropriate. A short account of non-Euclidean Geometries can be found in Cameron (pp31-40).

By contrast, applied mathematics is judged more by its ability to predict the future, than by its self-consistency. Applied mathematics is also based on axioms, but these are judged more on their ability to lead to calculations that can predict eclipses, cyclones, whether or not a suspension bridge will be able to support traffic loads, etc. In some cases such mathematical models can be very complex and may not give very accurate predictions. Applied mathematics is about getting a prediction, evaluating it (seeing how well it predicts the future) and then improving the model.

In summary, both branches of mathematics are based on axioms. These may or may not be designed to be ‘realistic’. What matters to the pure mathematician is that an axiom set should not lead to contradictions. The applied mathematician is looking for an axiom set and a mathematical structure built on these axioms that can be used to model the phenomena that we observe in nature. As we have seen, useful axiom sets need not start out being ‘sensible’.

The system of deduction that we use to build the other truths of mathematics is known as **proof**.

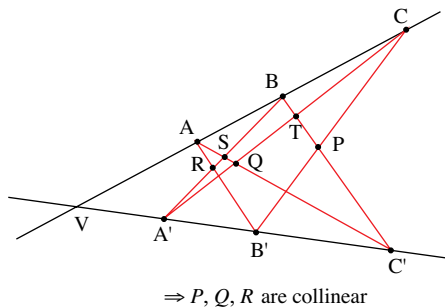

1.3 PROOF

Proof has a very special meaning in mathematics. We use the word generally to mean ‘proof beyond reasonable doubt’ in situations such as law courts when we accept some doubt in a verdict. For mathematicians, proof is an argument that has *no* doubt at all. When a new proof is published, it is scrutinised and criticised by other mathematicians and is accepted when it is established that every step in the argument is legitimate. Only when this has happened does a proof become accepted.

Technically, every step in a proof rests on the axioms of the mathematics that is being used. As we have seen, there is more than one set of axioms that could be chosen. The statements that we prove from the axioms are known as **theorems**. Once we have a theorem, it becomes a statement that we accept as true and which can be used in the proof of other theorems. In this way we build up a structure that constitutes a ‘mathematics’. The axioms are the foundations and the theorems are the superstructure. In the previous section we made use of the idea of consistency. This means that it must not be possible to use our axiom set to prove two theorems that are contradictory.

There are a variety of methods of proof available. This section will look at three of these in detail. We will mention others.

1.3.1 RULES OF INFERENCE

All proofs depend on rules of inference. Fundamental to these rules is the idea of ‘implication’.

As an example, we can say that $2x = 4$ (which is known as a **proposition**) implies that $x = 2$ (provided that x is a normal real number and that we are talking about normal arithmetic).

In mathematical shorthand we would write this statement as $2x = 4 \Rightarrow x = 2$.

This implication works both ways because $x = 2$ implies that $2x = 4$ also.

This is written as $x = 2 \Rightarrow 2x = 4$ or the fact that the **implication is both** ways can be written as

$$x = 2 \Leftrightarrow 2x = 4.$$

The \Leftrightarrow symbol is read as ‘**If and only if**’ or simply as ‘**Iff**’, i.e., If with two fs.

Not every implication works both ways in this manner:

If $x = 2$ then we can conclude that $x^2 = 4$.

However, we cannot conclude the reverse:

i.e., $x^2 = 4$ implies that $x = 2$ is false because x might be -2 .

So that $x = 2 \Rightarrow x^2 = 4$ is all that can be said in this case.

There are four main rules of inference:

1. The rule of detachment: from a is true and $a \Rightarrow b$ is true we can infer that b is true. a and b are propositions.

Example: If the following propositions are true:

It is raining.

If it is raining, I will take an umbrella.

We can infer that I will take an umbrella.

2. The rule of syllogism: from $a \Rightarrow b$ is true and $b \Rightarrow c$ is true, we can conclude that $a \Rightarrow c$ is true. a, b & c are propositions.

Example: If we accept as true that:
if x is an odd number then x is not divisible by 4 ($a \Rightarrow b$) and,
if x is not divisible by 4 then x is not divisible by 16 ($b \Rightarrow c$)

We can infer that the proposition;

if x is an odd number then x is not divisible by 16 ($a \Rightarrow c$) is true.

MATHEMATICS – Higher Level (Core)

- 3.** The rule of equivalence: at any stage in an argument we can replace any statement by an equivalent statement.

Example: If x is a whole number, the statement x is even could be replaced by the statement x is divisible by 2.

- 4.** The rule of substitution: If we have a true statement about all the elements of a set, then that statement is true about any individual member of the set.

Example: If we accept that all lions have sharp teeth then Benji, who is a lion, must have sharp teeth.

Now that we have our rules of inference, we can look at some of the most commonly used methods of proof

1.3.2 PROOF BY EXHAUSTION

This method can be, as its name implies, exhausting! It depends on testing every possible case of a theorem.

Example:

Consider the theorem: Every year must contain at least one ‘Friday the thirteenth’.

There are a limited number of possibilities as the first day of every year must be a Monday or a Tuesday or a Wednesday.... or a Sunday (7 possibilities). Taking the fact that the year might or might not be a leap year (with 366 days) means that there are going to be fourteen possibilities.

Once we have established all the possibilities, we would look at the calendar associated with each and establish whether or not it has a ‘Friday the thirteenth’. If, for example, we are looking at a non-leap year in which January 1st is a Saturday, there will be a ‘Friday the thirteenth’ in May. Take a look at all the possibilities (an electronic organiser helps!). Is the theorem true?

1.3.3 DIRECT PROOF

The following diagrams represent a proof of the theorem of Pythagoras described in 'The Ascent of Man' (Bronowski pp 158-161). The theorem states that the area of a square drawn on the hypotenuse of a right angled triangle is equal to the sum of the areas of the squares drawn on the two shorter sides. The method is direct in the sense that it makes no assumptions at the start. Can you follow the steps of this proof and draw the appropriate conclusion?

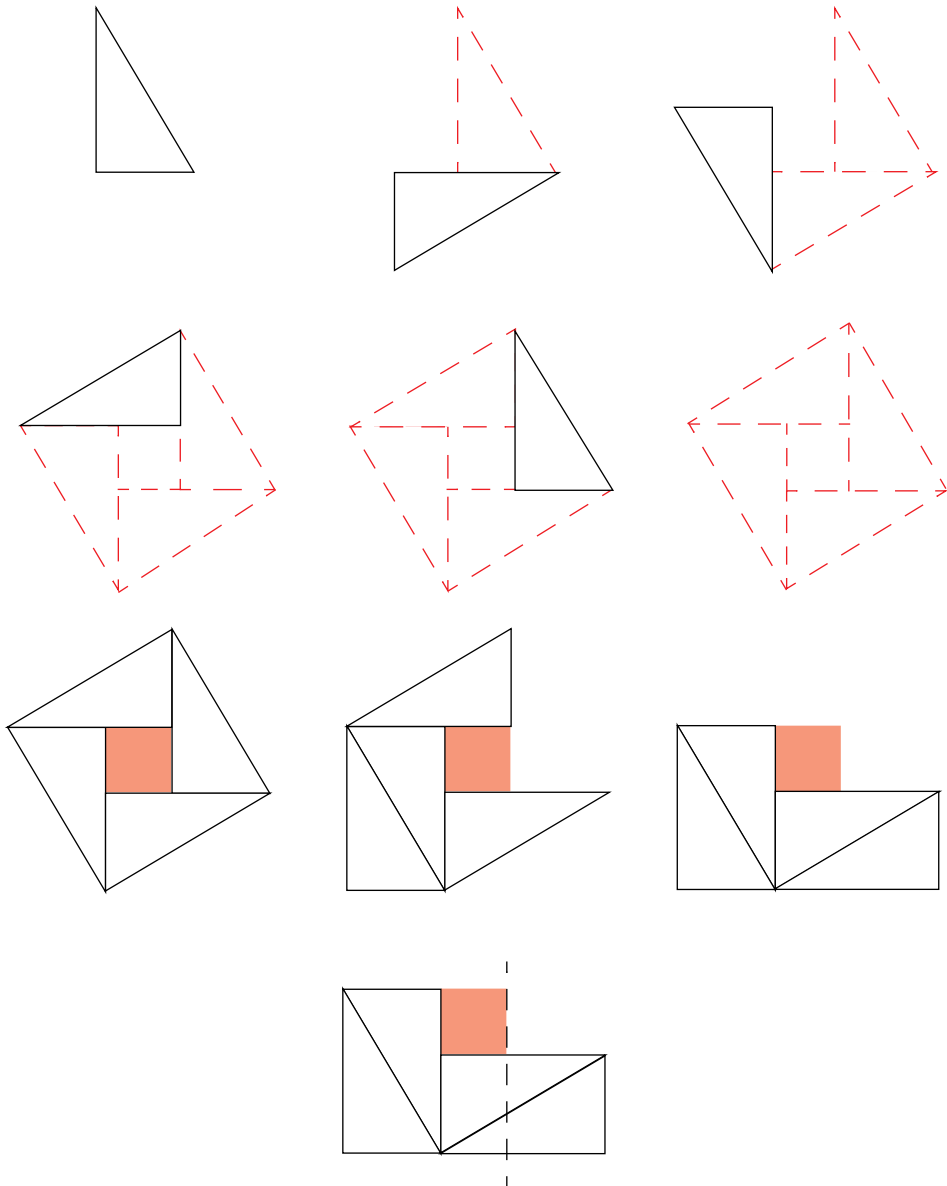

1.3.4 PROOF BY CONTRADICTION

This method works by assuming that the proposition is false and then proving that this assumption leads to a contradiction.

Example:

The number $\sqrt{2}$ greatly interested classical Greek mathematicians who were unable to find a number that, when it was squared, gave exactly 2.

Modern students are often fooled into thinking that their calculators give an exact square root for 2 as when 2 is entered and the square root button is pressed, a result (depending on the model of calculator) of 1.414213562 is produced. When this is squared, exactly 2 results. This is not because we have an exact square root. It results from the way in which the calculator is designed to calculate with more figures than it actually displays. The first answer is stored to more figures than are shown, the result is rounded and then displayed. The same is true of the second result which only rounds to 2. Try squaring 1.414213562, the answer is not 2.

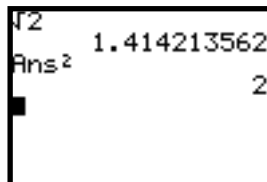

The theorem we shall prove is that there is *no* fraction that when squared gives 2. This also implies that there is no terminating or recurring decimal that, when squared, gives exactly 2, but this further theorem requires more argument.

The method begins by assuming that there *is* a fraction $\frac{p}{q}$ (p & q are integers) which has been cancelled to its lowest terms, such that $\frac{p}{q} = \sqrt{2}$. From the assumption, the argument proceeds:

$$\frac{p}{q} = \sqrt{2} \Rightarrow \frac{p^2}{q^2} = 2 \Rightarrow p^2 = 2q^2 \Rightarrow p^2 \text{ is even} \Rightarrow p \text{ is even}$$

As with most mathematical proofs, we have used simple axioms and theorems of arithmetic.

The most complex theorem used is that if p^2 is even, then p is even. Can you prove this?

The main proof continues with the deduction that if p is even there must be another *integer*, r , that is half p . $p = 2r \Rightarrow p^2 = 4r^2 \Rightarrow 2q^2 = 4r^2 \Rightarrow q^2 = 2r^2 \Rightarrow q^2$ is even $\Rightarrow q$ is even

We now have our contradiction as we assumed that $\frac{p}{q}$ was in its lowest terms so p & q cannot both be even. This proves the result, because we have a contradiction.

This theorem is a very strong statement of *impossibility*.

There are very few other areas of knowledge in which we can make similar statements. We might be virtually certain that we will never travel faster than the speed of light but it would be a brave physicist who would state with certainty that it is *impossible*. Other methods of proof include proof by induction which is mainly used to prove theorems involving sequences of statements. Whilst on the subject of proof, it is worth noting that it is much easier to disprove a statement than

to prove it. When we succeed in disproving a statement, we have succeeded in proving its negation or reverse. To disprove a statement, all we need is a single example of a case in which the theorem does not hold. Such a case is known as a **counter-example**.

Example:

The theorem ‘all prime numbers are odd’ is false. This can be established by noting that 2 is an even prime and, therefore, is the only counter-example we need to give. By this method we have proved the theorem that ‘not every prime number is odd’.

This is another example of the way in which pure mathematicians think in a slightly different way from other disciplines. Zoo-keepers (and indeed the rest of us) might be happy with the statement that ‘all giraffes have long necks’ and would not be very impressed with a pure mathematician who said that the statement was false because there was one giraffe (with a birth defect) who has a very short neck. This goes back to the slightly different standards of proof that are required in mathematics.

Counter-examples and proofs in mathematics may be difficult to find.

Consider the theorem that every odd positive integer is the sum of a prime number and twice the square of an integer. Examples of this theorem that do work are:

$$5 = 3 + 2 \times 1^2, 15 = 13 + 2 \times 1^2, 35 = 17 + 2 \times 3^2.$$

The theorem remains true for a very large number of cases and we do not arrive at a counter-example until 5777.

Another similar ‘theorem’ is known as the Goldbach Conjecture. Christian Goldbach (1690-1764) stated that every even number larger than 2 can be written as the sum of two primes. For example, $4 = 2 + 2$, $10 = 3 + 7$, $48 = 19 + 29$ etc. No-one has ever found a counter-example to this ‘simple’ conjecture and yet no accepted proof has ever been produced, despite the fact that the conjecture is not exactly recent!

Finally, whilst considering proof, it would be a mistake to think that mathematics is a complete set of truths that has nothing which needs to be added. We have already seen that there are unproved theorems that we suspect to be true. It is also the case that new branches of mathematics are emerging with a fair degree of regularity. During this course you will study linear programming which was developed in the 1940s to help solve the problems associated with the distribution of limited resources. Recently, both pure and applied mathematics have been enriched by the development of ‘Chaos Theory’. This has produced items of beauty such as the Mandelbrot set and insights into the workings of nature. It seems, for example, that the results of Chaos Theory indicate that accurate long term weather forecasts will never be possible (Mandelbrot).

1.4 PARADOX

1.4.1 WHAT IS A PARADOX?

Pure mathematics is a quest for a structure that does not contain internal contradictions. A satisfactory mathematics will contain no ‘nonsense’.

Consider the following proof:

Let $x = 1$	
Then $x^2 - 1 = x - 1$	Try substituting $x = 1$ to check this line.
$(x + 1)(x - 1) = x - 1$	Factorising using the difference of two squares.
$x + 1 = 1$	Dividing both sides by $x - 1$.
$2 = 1$	Substituting $x = 1$.

There is obviously something wrong here as this is the sort of inconsistency that we have discussed earlier in this chapter, but what is wrong? To discover this, we must check each line of the argument for errors or faulty reasoning.

- Line 1** must be acceptable as we are entitled to assign a numerical value to a pronumeral.
- Line 2** is true because the left hand and right hand sides are the same if we substitute the given value of the pronumeral.
- Line 3** is a simple factorisation of the left hand side.
- Line 4** is obtained from line 3 by dividing both sides of the equation by $x - 1$ and should be acceptable as we have ‘done the same thing’ to both sides of the equation.
- Line 5** is obtained from line 4 by substituting $x = 1$ and so should give the correct answer.

Obviously we have an unacceptable conclusion from a seemingly watertight argument. There must be something there that needs to be removed as an acceptable operation in mathematics.

The unacceptable operation is dividing both sides by $x - 1$ and then using a value of 1 for x . What we have effectively done is divide by a quantity that is zero. It is this operation that has allowed us to prove that $2 = 1$, an unacceptable result. When a **paradox** of this sort arises, we need to look at the steps of the proof to see if there is a faulty step. If there is, then the faulty step must be removed. In this case, we must add this rule to the allowed operations of mathematics:

Never divide by a quantity that is, or will become, zero.

This rule, often ignored by students, has important implications for Algebra and Calculus.

Some paradoxes are arguments that seem to be sound but contain a hidden error and thus do not contain serious implications for the structure of mathematical logic. An amusing compilation of simple paradoxes can be found in Gardner (1982). An example is the ‘elevator paradox’.

Why does it always seem that when we are waiting for an elevator near the bottom of a tall building and wanting to go up, the first elevator to arrive is always going down? Also, when we want to go back down, why is the first elevator to arrive always going up? Is this a real phenomenon or is it just a subjective result of our impatience for the elevator to arrive? Or is it another example of Murphy’s Law; whatever can go wrong will go wrong?

This is quite a complex question, but a simple explanation might run as follows:

If we are waiting near the bottom of a tall building, there are a small number of floors below us from which elevators that are going up might come and then pass our floor.

By contrast, there are more floors above us from which elevators going down.

On the basis of this and assuming that the elevators are randomly distributed amongst the floors, it is more likely that the next elevator to pass will come from above and will, therefore, be going down.

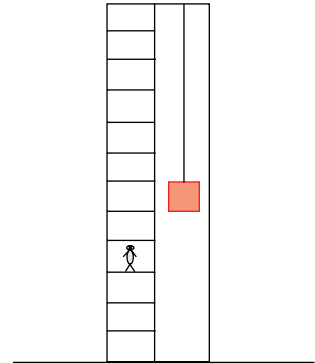

By contrast, if we are waiting near the top of a tall building, there are a small number of floors above us from which elevators that are going down might come and then pass our floor.

Also, there are more floors below us from which elevators might come and then pass our floor going up.

It is more likely that the next elevator to pass will come from below and will, therefore, be going up.

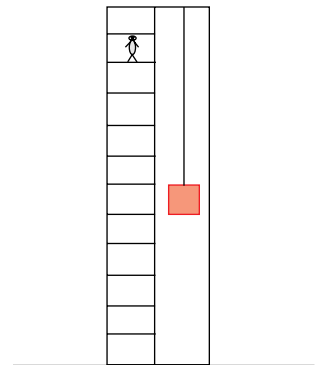

A fuller analysis of this paradox can be found in Gardner (pp96-97).

The elevator paradox does not contain serious implication for the structure of mathematics like our first example. We will conclude this section with a look at a modern paradox that did cause a re-evaluation of one of the basic ideas of mathematics, the set.

1.4.2 RUSSELL'S PARADOX

Bertrand Russell (1872-1970) looked in detail at the basic set axioms of mathematics. We do regard the existence of sets as axiomatic in all mathematical structures. Does this mean that we can make a set that contains 'everything'? There would seem to be no difficulty with this as we just move around the universe and sweep everything that we meet into our set, numbers, words, whales, motorcycles etc. and the result is the set that contains everything.

Russell posed the following question which we will relate in the context of library catalogues.

Every library has a catalogue. There are various forms that this catalogue might take; a book, a set of cards, a computer disc etc. Whatever form the catalogue in your local library takes, there is a sense in which this catalogue is a book (or publication) owned by the library and, as such, should appear as an entry in the catalogue:

CATALOGUE	NEWEL LIBRARY
Castle, The. F Kafka 231.72	Catherine the Great A Biography J Nelson 217.42
Catalogue At reception	Catullus The complete works Edited by F Wills 312.42
Catcher in the Rye JD Salinger 123.64	

Of course, many librarians will decide that it is silly to include the catalogue as an entry in the catalogue because people who are already looking at the catalogue know where to find it in the

MATHEMATICS – Higher Level (Core)

library! It follows that library catalogues can be divided into two distinct groups:

Catalogues that do contain an entry describing themselves.

Catalogues that do not contain an entry describing themselves.

Next, let us make a catalogue of *all* the catalogues of type two, those that do not contain themselves.

This gives us a problem. Should we include an entry describing our new catalogue? If we do, then our catalogue ceases to be a catalogue of all those catalogues that do not contain themselves. If we do not, then our catalogue is no longer a complete catalogue of all those catalogues that do not contain themselves.

The conclusion is that making such a catalogue is impossible. This does not mean that the library catalogues themselves cannot exist. We have, however, defined an impossible catalogue.

In set terms, Russell's paradox says that sets are of two types:

Type 1 Sets that do contain themselves.

Type 2 Sets that do not contain themselves.

The set of all sets of type 2 cannot be properly defined without reaching a contradiction.

The most commonly accepted result of Russell's paradox is the conclusion that we have to be very careful when we talk about sets of everything. The most usual way out is to work within a carefully defined universal set, chosen to be appropriate to the mathematics that we are undertaking. If we are doing normal arithmetic, the universal set is the set of real numbers.

1.5

MATHEMATICS AND OTHER DISCIPLINES

When writing Theory of Knowledge essays, students are required to develop their arguments in a cross disciplinary way. For more details on this, you are strongly advised to read the task specifications and the assessment criteria that accompany the essay title. You are reminded that it is these statements that define what is expected of a good essay, not the contents of this Chapter which have been provided as a background resource. A good essay will only result if you develop your own ideas and examples in a clear and connected manner. Part of this process may include comparing the 'mathematical method' described earlier with the methods that are appropriate to other systems of knowledge.

As we have seen, mathematics rests on sets of axioms. This is true of many other disciplines. There is a sense in which many ethical systems also have their axioms such as 'Thou shalt not kill'.

The Ancient Greeks believed that beauty and harmony are based, almost axiomatically, on mathematical proportions. The golden mean is found by dividing a line in the following ratio:



The ratio of the length AB to the length BC is the same as the ratio of the length BC to the whole

length AC. The actual ratio is $1:\frac{1}{2}(1 + \sqrt{5})$ or about 1:1.618. The Greek idea was that if this line is converted into a rectangle, then the shape produced would be in perfect proportion:

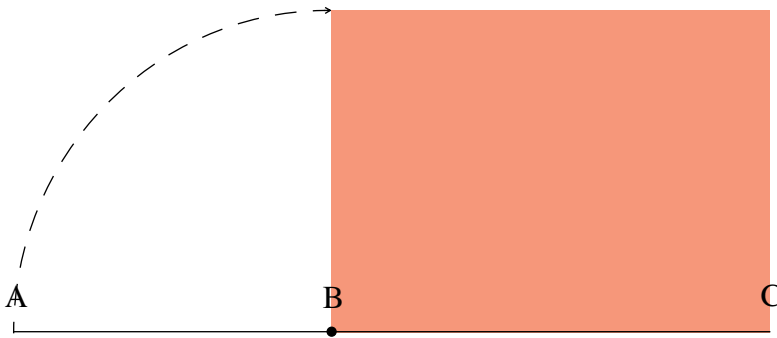

Likewise, the correct place to put the centre of interest in a picture is placed at the golden mean position between the sides and also at the golden mean between top and bottom. Take a look at the way in which television pictures are composed to see if we still use this idea:

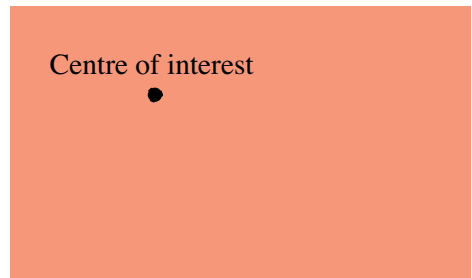

In a similar way, the Ancient Greeks believed that ratio determined harmony in music. If two similar strings whose lengths bear a simple ratio such as 1:2 or 2:3 are plucked together the resulting sound will be pleasant (harmonious). If the ratio of string lengths is 'awkward', such as 17:19, then the notes will be discordant. The same principle of simple ratios is used in tuning musical instruments (in most cultures) today.

The most common connection between mathematics and other disciplines is the use of mathematics as a tool. Examples are: the use of statistics by insurance actuaries, probability by quality control officers and of almost all branches of mathematics by engineers. Every time mathematics is used in this way, there is an assumption that the calculations will be done using techniques that produce consistent and correct answers. It is here that pure mathematical techniques, applied mathematical modelling and other disciplines interface.

In some of these examples, we apply very precise criteria to our calculations and are prepared to accept only very low levels of error. Navigation satellite systems work by measuring the position of a point on or above the Earth relative to the positions of satellites orbiting the Earth.

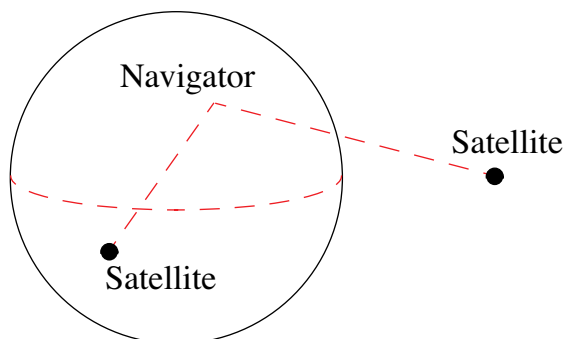

MATHEMATICS – Higher Level (Core)

This system will only work if the positions of the satellites are known with very great precision.

By contrast, when calculations are made to forecast the weather, whilst they are done with as much precision as necessary, because the data is incomplete and the atmospheric models used are approximate, the results of the calculations are, at best, only an indication of what might happen. Fortunately, most of us expect this and are much more tolerant of errors in weather forecasting than we would be if airlines regularly failed to find their destinations!

There are, therefore a large number of ways in which mathematics complements other disciplines. In fact, because computers are essentially mathematical devices and we are increasingly dependent on them, it could be argued that mathematics and its methods underpin the modern world.

That is not to say that mathematics is ‘everywhere’. Many very successful people have managed to avoid the subject altogether. Great art, music and poetry has been produced by people for whom mathematical ideas held little interest.

In using mathematical ideas in essays, remember that you should produce original examples, look at them in a mathematical context and then compare the ways in which the example might appear to a mathematician with the way in which the same example might appear to a thinker from another discipline.

As a very simple example, what should we think of gambling?

To the mathematician (Pascal was one of the first to look at this activity from the mathematical perspective), a gambling game is a probability event. The outcome of a single spin of a roulette wheel is unknown. If we place a single bet, we can only know the chances of winning, not whether or not we *will* win. Also, in the long run, we can expect to lose one thirtyseventh of any money that we bet every time we play. To the mathematician, (or at least to this mathematician) this rather removes the interest from the game!

Other people look at gambling from a different standpoint. To the politician, a casino is a source of revenue and possibly a focus of some social problems. To a social scientist, the major concern might be problem gamblers and the effect that gambling has on the fabric of society. A theologian might look at the ethical issues as being paramount. Is it ethical to take money for a service such as is provided by a casino? Many of these people might use mathematics in their investigations, but they are all bringing a slightly different view to the discussion.

As we can see, there are many sides to this question as there are many sides to most questions. Mathematics can often illuminate these, but will seldom provide all the answers. When you choose an essay title, you do not have to use mathematical ideas or a mathematical method to develop your analysis. However, we hope that if you do choose to do this, you will find the brief sketch of the mathematical method described in this Chapter helpful.

We will finish with one observation.

Mathematics and mathematicians are sometimes viewed as dry and unimaginative. This may be true in some cases, but definitely not all.

We conclude with some remarks by the mathematician Charles Dodgson (1832-1898), otherwise known as Lewis Carroll:

‘The time has come’, the Walrus said,
 ‘To talk of many things:
 Of shoes and ships and sealing wax,
 Of cabbages and kings,
 Of why the sea is boiling hot
 And whether pigs have wings’.
 Through the Looking Glass

References:

Megalithic Sites in Britain. Thom, A. (1967). U.K. Oxford University Press.

Heritage Mathematics. Cameron, M. (1984).U.K. E.J. Arnold.

The Ascent of Man, Bronowski, J. (1973).U.K. BBC.

The Fractal Geometry of Nature, Mandelbrot, B (1977), U.S. W.H. Freeman & Co. 1977.

Gotcha!, Gardner, M. (1977). U.S.A. W.H. Freeman & Co.

1.6 THE EXTENDED ESSAY

We would like to encourage students to consider Mathematics as a choice of subject for their extended essay.

Whilst there is a requirement that these have solid academic content, it is not necessary to record an original discovery to produce an excellent essay! That said, many of the great original discoveries of mathematics are the work of comparatively young individuals with a modest level of ‘experience’.

An excellent example is Evariste Galois who struggled to enter university and whose life was cut short by a duel in 1832 at age 21. Galois left a set of ‘memoirs’, many of which were written on the night before the duel, that are regarded as some of the most original ideas ever contributed to mathematics.

It is fashionable today to regard this sort of original thought as the preserve of ‘experts’. We assert that it is not and encourage all our students to believe that they are capable of original ideas and hope that, if they do have a new idea, they have the courage to explore it.

Students might choose to look at some of the many simply stated but as yet unproved conjectures of mathematics:

- 1.** There are an infinite number of prime numbers. Pairs of primes such as 5 & 7, 11 & 13 that are separated by one even number are called ‘twin primes’.
How many twin primes are there?
- 2.** The Goldbach conjecture: ‘Every even natural number greater than 2 is equal to the sum of two prime numbers’ remains unproved.
- 3.** If an infinite number of canon-balls are stacked in an infinite pyramid, what is the biggest proportion of the space they can fill?
- 4.** What are Mersenne primes and can you find a new one? The 25th & 26th Mersenne primes were found by high school students.

... and a lot more!

MATHEMATICS – Higher Level (Core)

As a short case study, we will outline the work of a student who undertook a mathematical essay. The topic she chose was ‘The Mathematics of Knots’.

To begin with, **the student displayed an understanding** of two of the major ‘ways of thinking’ that are characteristic of mathematicians: EXISTENCE and CLASSIFICATION.

EXISTENCE means developing tests for when a knot does or does not exist. It is neither possible nor appropriate to explore all these ideas in an introduction such as this, but the essentials are illustrated below.

Take a look at these two photographs of ‘knots’:

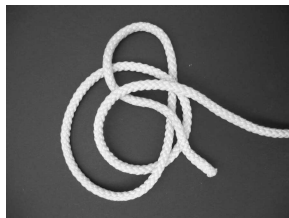
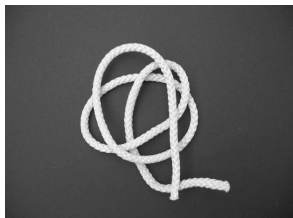

These look similar, but if the ends are pulled apart, the results are quite different:

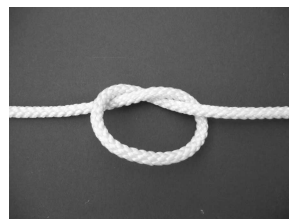
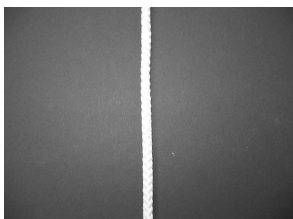

The left hand arrangement was a ‘tangle’ whereas the right was a ‘knot’.

The student investigated and skillfully explained the tests that can be applied to such rope arrangements to determine if a knot EXISTS.

The second feature of this essay was a look at the CLASSIFICATION of knots. These two photographs show knots that have two different applications:



Sheet bend

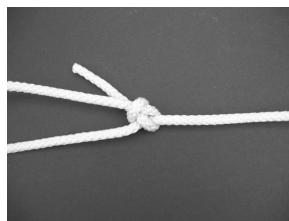

Bowline

These knots have two different uses. The sheet bend is used to join two lengths of rope and is designed not to ‘slip’. The bowline (pronounced ‘bo-lin’) is the knot you tie around your waist if you are drowning and a rescuer throws you a rescue rope. It will not slip or tighten around you and, irrespective of mathematics, is well worth knowing!

These knots have different uses and belong to different CLASSES of knot. There are knots similar to the bowline that are intended to slip (such as the ‘noose’) that belong to yet another class of knots. What are the classes of knots and what are their mathematical characteristics?

2.1 THE REAL NUMBER LINE

2.1.1 THE REAL NUMBER LINE

A visual method to represent the set of **real numbers**, \mathbb{R} , is to use a straight line. This geometrical representation is known as the **real number line**. It is usually drawn as a horizontal straight line extending out indefinitely in two directions with a point of reference known as the origin, usually denoted by the letter O. Corresponding to every real number x there is a point P, on the line, representing this value. If $x > 0$, the point P lies to the right of O. If $x < 0$ the point P lies to the left of O. If $x = 0$, the point P is at the origin, O.

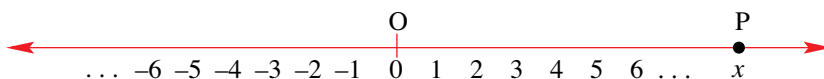

2.1.2 SET BUILDER NOTATION

The set of points on the real number line can also be written in an algebraic form:

$$\mathbb{R} = \{x : -\infty < x < \infty\}$$

This means that any real number set can be expressed algebraically. For example, the set of

$$\text{positive real numbers} = \mathbb{R}^+ = \{x : x > 0\},$$

$$\text{negative real numbers} = \mathbb{R}^- = \{x : x < 0\}$$

Note that $\mathbb{R} = \mathbb{R}^- \cup \{0\} \cup \mathbb{R}^+$.

Similarly we can construct any subset of the real number line. The great thing about using set notation is that we can quickly identify if a point on the number line is included or excluded in the set. How do we represent these inclusions and exclusions on the real number line?

If the number is **included** in the set, you ‘black-out’ a circle at that point on the number line – this is called a **closed circle**.

For example, the set $\{x : x \geq 3\}$ has the following representation:



If the number is **excluded** from the set, you place a circle at that point on the number line – this is called an **open circle**.

For example, the set $\{x : x > 3\}$ has the following representation:

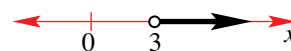

2.1.3 INTERVAL NOTATION

Another notation that is used to describe subsets of the real numbers is **interval notation**. This form of notation makes use of only ‘square brackets’ or ‘square brackets’ and ‘round brackets’ to indicate if a number is included or excluded. For the examples above we have:

$$\{x : x \geq 3\} = [3, \infty) \text{ or } [3, \infty[$$

and for

$$\{x : x > 3\} = (3, \infty) \text{ or }]3, \infty[$$

Notice that ‘ ∞ ’ is never included!

MATHEMATICS – Higher Level (Core)

It should be noted that $\{x : x \geq 3\}$ can also be expressed as $\{x : 3 \leq x < \infty\}$. Hence the reason for having ‘ ∞ ’ in the interval notation representation.

A summary of the different possible intervals is given in the table below:

Real Number Line	Set Notation	Interval Notation	Example
	$\{x : a \leq x \leq b\}$	$x \in [a, b]$	 $\{x : 3 \leq x \leq 8\}$ or $x \in [3, 8]$
	$\{x : a \leq x < b\}$	$x \in [a, b)$ or $x \in [a, b[$	 $\{x : 3 \leq x < 8\}$ or $x \in [3, 8)$ $x \in [3, 8[$
	$\{x : a < x \leq b\}$	$x \in (a, b]$ or $x \in]a, b]$	 $\{x : 3 < x \leq 8\}$ or $x \in (3, 8]$ $x \in]3, 8]$
	$\{x : a < x < b\}$	$x \in (a, b)$ or $x \in]a, b[$	 $\{x : 3 < x < 8\}$ or $x \in (3, 8)$ $x \in]3, 8[$
	$\{x : x \geq a\}$ or $\{x : a \leq x < \infty\}$	$x \in [a, \infty)$ or $x \in [a, \infty[$	 $\{x : x \geq 3\}$ or $x \in [3, \infty)$ $x \in [3, \infty[$
	$\{x : x > a\}$ or $\{x : a < x < \infty\}$	$x \in (a, \infty)$ or $x \in]a, \infty[$	 $\{x : x > 3\}$ or $x \in (3, \infty)$ $x \in]3, \infty[$
	$\{x : x \leq a\}$ or $\{x : -\infty < x \leq a\}$	$x \in (-\infty, a]$ or $x \in]-\infty, a]$	 $\{x : x \leq 8\}$ or $x \in (-\infty, 8]$ $x \in]-\infty, 8]$
	$\{x : x < a\}$ or $\{x : -\infty < x < a\}$	$x \in (-\infty, a)$ or $x \in]-\infty, a[$	 $\{x : x < 8\}$ or $x \in (-\infty, 8)$ $x \in]-\infty, 8[$

We also make the following point in relation to set notation. Rather than using the colon ‘:’ in expressions such as $\{x : x < 3\}$ we can also use the separator ‘|’. That is, $\{x | x < 3\}$. Either notation can be used.

2.1.4 NUMBER SYSTEMS

The set of real numbers can be broken down into two subsets, namely, the set of **rational numbers** and the set of **irrational numbers**. The set of rational numbers can itself be broken down into two sets, the set of **integers** and the set of fractions. The set of integers can then be broken down into the set of positive integers, the set of negative integers and the set that includes the number zero. Each of these sets can be represented by a different symbol.

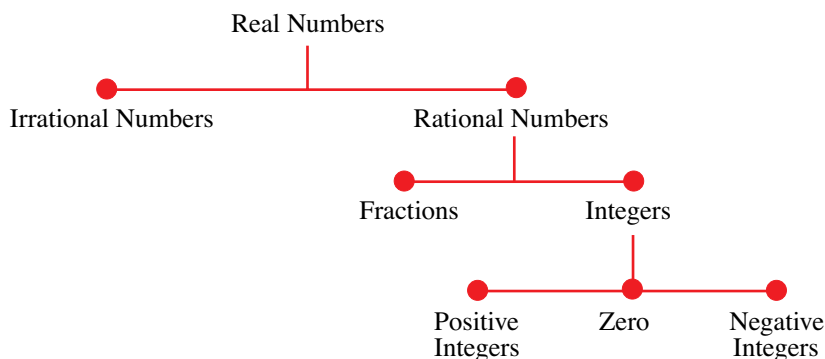

In this book we will use the following notation and definitions:

Set of positive integers and zero = $\mathbb{N} = \{0, 1, 2, 3, \dots\}$.

The set of integers = $\mathbb{Z} = \{0, \pm 1, \pm 2, \pm 3, \dots\}$

The set of positive integers = $\mathbb{Z}^+ = \{1, 2, 3, \dots\}$ [Also known as Natural numbers]

The set of rational numbers = \mathbb{Q}

Definition: $\mathbb{Q} = \left\{ x \mid x = \frac{a}{b}, b \neq 0 \text{ and } a \text{ and } b \text{ are integers} \right\}$

The set of positive rational numbers = \mathbb{Q}^+

The set of positive real numbers = $\mathbb{R}^+ = \{x \mid x \in \mathbb{R}, x > 0\}$

The empty set = \emptyset = The set with *no* members.



EXAMPLE 2.1

- (a) Write each of the following using interval notation.
 (b) Represent the sets on the real number line.

i. $\{x \mid -1 < x \leq 4\}$

ii. $\{x \mid x \geq 3\} \cap \{x \mid x < 6\}$

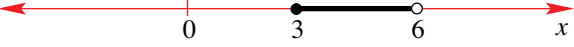
iii. $\{x : x < 8\} \setminus \{5\}$

- i. (a) $\{x \mid -1 < x \leq 4\} =]-1, 4]$ or using round bracket: $(-1, 4]$.
 (b) 
- ii. (a) $\{x \mid x \geq 3\} \cap \{x \mid x < 6\} = [3, \infty[\cap]\infty, 6[= [3, 6[$ or $[3, 6)$ – using round bracket.
 (b) 
- iii. (a) $\{x : x < 8\} \setminus \{5\} =]-\infty, 8[\setminus \{5\}$ or $(-\infty, 8) \setminus \{5\}$ – using round brackets.
 (b) 

2.1.5 IRRATIONAL NUMBERS

We provided a definition of rational numbers earlier. The question then remains, what is an irrational number? The obvious answer is ‘Whatever is not a rational number’! So, what do these numbers look like? The best way to answer this is to say that it is a number that cannot be written in the form $\frac{a}{b}$, $b \neq 0$ where a and b are integers. Examples of irrational numbers are $\sqrt{2}$, $\sqrt{3}$, π and so on.

How do we know that $\sqrt{2}$ is an irrational number?

We can show this as follows – a process known as *reductio ad absurdum* – meaning to prove by contradiction:

Assume that $\sqrt{2}$ is a rational number. Then by the definition of rational numbers there exist integers a and b (where a and b have no common factors) such that

$$\sqrt{2} = \frac{a}{b}, b \neq 0$$

Upon squaring we have:

$$2 = \frac{a^2}{b^2}$$

$$\Leftrightarrow a^2 = 2b^2$$

Then, a^2 must be even [because $2b^2$ is even – i.e., any number multiplied by 2 is even] and so a must also be even.

This means we can express a as $2k$. So, setting $a = 2k$ we have:

$$a^2 = 4k^2$$

But, $a^2 = 2b^2$, so that

$$2b^2 = 4k^2$$

$$\Leftrightarrow b^2 = 2k^2$$

And so, b^2 must also be even, meaning that b is even.

Then, since both a and b are even it follows that a and b have a common factor (i.e., 2).

This is contrary to our original hypothesis. Therefore $\sqrt{2}$ is not a rational number and must therefore be an irrational number.

One subset of irrational numbers is known as the set of **surds**. Surds can be expressed in the form

$\sqrt[n]{a}$ where $n \in \mathbb{Z}^+$ and $a \in \mathbb{Q}^+$. A commonly encountered surd is \sqrt{a} (i.e., the square root).

The laws of operations apply to surds in the same way that they apply to real numbers. We summarise some results involving surds:

$$\begin{aligned}\sqrt{a} \times \sqrt{b} &= \sqrt{ab} \\ \frac{\sqrt{a}}{\sqrt{b}} &= \sqrt{\frac{a}{b}} \\ \sqrt{a^2b} &= a\sqrt{b}, a > 0 \\ a\sqrt{b} \times c\sqrt{d} &= ac\sqrt{bd} \\ (\sqrt{a} + \sqrt{b})(\sqrt{a} - \sqrt{b}) &= a - b\end{aligned}$$

Notice that the last result shows that we obtain a rational number! The surds $\sqrt{a} - \sqrt{b}$ and $\sqrt{a} + \sqrt{b}$ are known as **conjugate pairs**. Whenever conjugate pairs are multiplied together they produce a rational number.

EXAMPLE 2.2

Expand the following

(a) $(\sqrt{2} + \sqrt{3})(\sqrt{6} - 3)$ (b) $(\sqrt{5} - 2\sqrt{3})(\sqrt{5} - \sqrt{3})$

Solution

(a)
$$\begin{aligned}(\sqrt{2} + \sqrt{3})(\sqrt{6} - 3) &= \sqrt{2} \times \sqrt{6} - 3 \times \sqrt{2} + \sqrt{3} \times \sqrt{6} - 3 \times \sqrt{3} \\ &= \sqrt{2} \times (\sqrt{2} \times \sqrt{3}) - 3\sqrt{2} + \sqrt{3} \times (\sqrt{3} \times \sqrt{2}) - 3\sqrt{3} \\ &= 2\sqrt{3} - 3\sqrt{2} + 3\sqrt{2} - 3\sqrt{3} \\ &= -\sqrt{3}\end{aligned}$$

(b)
$$\begin{aligned}(\sqrt{5} - 2\sqrt{3})(\sqrt{5} - \sqrt{3}) &= \sqrt{5} \times \sqrt{5} - \sqrt{5} \times \sqrt{3} - 2\sqrt{3} \times \sqrt{5} + 2\sqrt{3} \times \sqrt{3} \\ &= 5 - \sqrt{15} - 2\sqrt{15} + 2 \times 3 \\ &= 11 - 3\sqrt{15}\end{aligned}$$

EXAMPLE 2.3

Rationalise the denominator of

(a) $\frac{1}{2 + \sqrt{2}}$ (b) $\frac{1 + \sqrt{2}}{2\sqrt{3} - 1}$

Solution

(a)
$$\begin{aligned}\frac{1}{2 + \sqrt{2}} &= \frac{1}{2 + \sqrt{2}} \times \frac{2 - \sqrt{2}}{2 - \sqrt{2}} \quad [\text{multiplying numerator and denominator by conjugate}] \\ &= \frac{2 - \sqrt{2}}{4 - 2} \\ &= 1 - \frac{1}{2}\sqrt{2}\end{aligned}$$

(b)
$$\begin{aligned}\frac{1 + \sqrt{2}}{2\sqrt{3} - 1} &= \frac{1 + \sqrt{2}}{2\sqrt{3} - 1} \times \frac{2\sqrt{3} + 1}{2\sqrt{3} + 1} = \frac{2\sqrt{3} + 1 + 2\sqrt{6} + \sqrt{2}}{4 \times 3 - 1} \\ &= \frac{2\sqrt{3} + 1 + 2\sqrt{6} + \sqrt{2}}{11} \quad [\text{cannot be simplified further}]\end{aligned}$$

2.1.6 THE ABSOLUTE VALUE

The **absolute value** or **modulus** of a number x , denoted by $|x|$, is defined as follows:

$$\text{If } x \geq 0 \Rightarrow |x| = x \text{ and if } x < 0 \Rightarrow |x| = -x.$$

This means that the absolute value of any number will always be positive.

E.g., $|4| = 4$:- seeing as $4 > 0$, we use the value of 4. Whereas, $|-2| = -(-2) = 2$:- by taking the negative of a negative number we obtain a positive number.

EXAMPLE 2.4

- (a) Find $\{x : |x| = 7\}$.
- (b) Use the number line to represent the sets
- i. $\{x : |x| \leq 3\}$ ii. $\{x : |x| > 1\}$
- Express these sets using interval notation.

S
o
l
u
t
i
o
n

- (a) We are looking for value(s) of x such that when we take the absolute value of x it is 7. From the definition of the absolute value, we must have that $x = 7$ or $x = -7$. That is, $|x| = 7 \Leftrightarrow x = \pm 7$. Therefore, the solution set is $\{7, -7\}$

- (b) i This time we want all values of x such that their absolute value is less than or equal to 3. For example, if $x = -2.5$ then $|-2.5| = 2.5$ which is less than 3. However, if $x = -4$ then $|-4| = 4$ which is greater than 3. So we cannot have $x = -4$. Working along these lines we must have:



Using interval notation we have $\{x : |x| \leq 3\} = \{x : -3 \leq x \leq 3\} = [-3, 3]$

- ii. This time we want numbers for which their absolute value is greater than 1. For example, $|1.2| = 1.2 > 1$ and $|-3.2| = 3.2 > 1$. We then have:

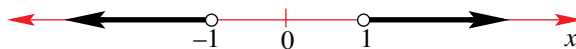

Using interval notation we have $\{x : |x| > 1\} =]-\infty, -1[\cup]1, \infty[$

EXERCISES 2.1

1. Show the following sets on the real number line.

- (a) $\{x | 2 \leq x \leq 8\}$ (b) $\{x | x > 7\}$ (c) $\{x | -2 < x \leq 6\} \setminus \{4\}$
 (d) $]2, 7] \cap]4, 8[$ (e) $(-\infty, 4) \cap [-2, 5)$ (f) $\{x : x < -6\}$

2. Write the following using interval notation.

- (a) $\{x | -2 \leq x \leq 7\}$ (b) $\{x | x > 9\}$
 (c) $\{x | 0 < x \leq 5\}$ (d) $\{x : x \leq 0\}$
 (e) $\{x : x < 8\} \cap \{x : x > -4\}$ (f) $\{x : x < -1\} \cup \{x : x > 2\}$

3. Simplify the following.

(a) $3\sqrt{5} + \sqrt{20}$ (b) $2\sqrt{3} - \sqrt{27}$ (c) $\sqrt{2} + \sqrt{3} + \sqrt{8} - \sqrt{18}$

4. Simplify the following.

(a) $(\sqrt{5} + 1)(\sqrt{5} - 1)$ (b) $(2\sqrt{3} - \sqrt{2})(\sqrt{2} + \sqrt{3})$
 (c) $(3\sqrt{2} - \sqrt{6})(\sqrt{3} + 3)$ (d) $(2 + 3\sqrt{3})^2$

5. Rationalise the denominator in each of the following.

(a) $\frac{1}{2 + \sqrt{3}}$ (b) $\frac{3}{\sqrt{7} - 2}$ (c) $\frac{\sqrt{3}}{\sqrt{5} - 2}$
 (d) $\frac{2\sqrt{5} + 1}{\sqrt{3} - 2}$ (e) $\frac{\sqrt{2} + \sqrt{3}}{\sqrt{3} - \sqrt{5}}$ (f) $\frac{2\sqrt{3}}{2\sqrt{5} - 3\sqrt{2}}$

6. (a) If $x = \sqrt{5} + \sqrt{3}$, find the value of i. $x + \frac{1}{x}$ ii. $x^2 + \frac{1}{x^2}$
 (b) If $x = 4 + \sqrt{3}$, find the value of i. $x - \frac{1}{x}$ ii. $x^2 + \frac{1}{x^2}$

7. Find the value of x if

(a) $\{x \mid |x| = 3\}$ (b) $\{x \mid |x| = 10\}$ (c) $\{x \mid |x| = -2\}$
 (d) $\{x \mid |x + 1| = 3\}$ (e) $\{x \mid |x + 2| = 10\}$ (f) $\{x \mid |x - 2| = 2\}$

8. Represent each of the following on the real number line.

(a) $\{x : |x| \leq 5\}$ (b) $\{x \mid |x| > 2\}$
 (c) $\{x : 2 \leq |x| < 5\}$ (d) $\{x : 2|x| \geq 8\}$

9. Write the following using interval notation.

(a) $\{x \mid x - 1 > 0\}$ (b) $\left\{x \mid \frac{1}{2}x > 2\right\}$ (c) $\{x : x > 4\} \cap \{x : 2x < 12\}$

10. Prove each of the following if $a \in \mathbb{R}, b \in \mathbb{R}$.

(a) $|ab| = |a||b|$
 (b) $\left|\frac{a}{b}\right| = \frac{|a|}{|b|}, b \neq 0$
 (c) $|a + b| \leq |a| + |b|$
 (d) $|a - b| \leq |a| + |b|$
 (e) $||a| - |b|| \leq |a - b|$

11. Find the square root of the following.

(a) $9 + 2\sqrt{18}$
 (b) $12 - 2\sqrt{32}$

2.2 LINEAR ALGEBRA

2.2.1 REVIEW OF LINEAR EQUATIONS

A **linear equation** in the **variable** x (say) takes on the form $ax + b = c$ where a, b and c are real constants. The equation is linear because x is raised to the power of one. To solve such equations we use the rules of transposition:

$$\begin{aligned} ax + b &= c \Leftrightarrow ax = c - b \\ \Leftrightarrow x &= \frac{c - b}{a} \end{aligned}$$

Solving $ax + b = c$ produces a solution that can be represented on the real number line.

EXAMPLE 2.5

Solve the following linear equations

(a) $4x + 5 = 21$ (b) $9 - 2x = 7$ (c) $3(5x - 2) = 12$

Solution

(a) $4x + 5 = 21 \Leftrightarrow 4x = 16 \Leftrightarrow x = 4$

(b) $9 - 2x = 7 \Leftrightarrow -2x = -2 \Leftrightarrow x = 1$

(c) $3(5x - 2) = 12 \Leftrightarrow 15x - 6 = 12$ [don't forget to multiply the 3 and -2]
 $\Leftrightarrow 15x = 18$
 $\Leftrightarrow x = \frac{6}{5}$

Sometimes equations might not appear to be linear, but with some algebra, they form into linear equations. The following examples shows how this works.

EXAMPLE 2.6

(a) Solve for x , $\frac{x-3}{2} - 1 = x$.

(b) Find $\left\{ x \mid \frac{x}{3} - \frac{2-x}{2} = 1 \right\}$.

Solution

(a) $\frac{x-3}{2} - 1 = x \Leftrightarrow \frac{x-3}{2} = x+1 \Leftrightarrow x-3 = 2(x+1)$

$$\Leftrightarrow x-3 = 2x+2$$

$$\Leftrightarrow -x = 5$$

$$\therefore x = -5$$

(b) $\frac{x}{3} - \frac{2-x}{2} = 1 \Leftrightarrow \frac{2x}{6} - \frac{3(2-x)}{6} = 1 \Leftrightarrow 2x - 3(2-x) = 6$

$$\begin{aligned}\Leftrightarrow 2x - 6 + 3x &= 6 \\ \Leftrightarrow 5x &= 12 \\ \Leftrightarrow x &= \frac{12}{5}\end{aligned}$$

EXAMPLE 2.7

Solve the following literal equations for x , where a and b are real constants.

(a) $bx - b^2 = ab$ (b) $bx = a(b - x)$

**S
o
l
u
t
i
o
n**

(a) $bx - b^2 = ab \Leftrightarrow bx = ab + b^2 \Leftrightarrow bx = b(a + b)$ [taking b out as a common factor]
 $\Leftrightarrow x = a + b$ [dividing both sides by b]

(b) $bx = a(b - x) \Leftrightarrow bx = ab - ax \Leftrightarrow bx + ax = ab$
 $\Leftrightarrow (b + a)x = ab$
 $\Leftrightarrow x = \frac{ab}{b + a}$

Linear Equations involving Absolute values

Recall that if $|x| = a$ (where $a \geq 0$) then, $x = a$ or $-a$. Using this result we can solve similar linear equations.

That is, $|ax + b| = c \Leftrightarrow ax + b = c$ or $ax + b = -c$
 $\Leftrightarrow ax = c - b$ or $ax = -c - b$
 $\Leftrightarrow x = \frac{c - b}{a}$ or $x = -\frac{(c + b)}{a}$

Notice that this time we have two solutions!

EXAMPLE 2.8

Solve the following.

(a) $|2x| = 6$ (b) $|x - 1| = 5$ (c) $\left|3 - \frac{1}{2}x\right| = 2$

**S
o
l
u
t
i
o
n**

(a) $|2x| = 6 \Leftrightarrow 2x = 6$ or $2x = -6$
 $\Leftrightarrow x = 3$ or $x = -3$

(b) $|x - 1| = 5 \Leftrightarrow x - 1 = 5$ or $x - 1 = -5$
 $\Leftrightarrow x = 6$ or $x = -4$

(c) $\left|3 - \frac{1}{2}x\right| = 2 \Leftrightarrow 3 - \frac{1}{2}x = 2$ or $3 - \frac{1}{2}x = -2$

$$\Leftrightarrow -\frac{1}{2}x = -1 \text{ or } -\frac{1}{2}x = -5$$

$$\Leftrightarrow x = 2 \text{ or } x = 10$$

Examples such as those that follow require careful consideration of the restrictions placed on the absolute values of the variables. We work through a number of such equations.

EXAMPLE 2.9

Solve the following.

(a) $|x| = 2x + 1$ (b) $|x - 1| = x$ (c) $|3 - x| = x - 1$

**S
o
l
u
t
i
o
n**

(a) By definition, $|x| = x$ if $x \geq 0$ and $-x$ if $x < 0$. Therefore we have two separate equations to solve, one for $x \geq 0$ and one for $x < 0$.

Case 1 ($x \geq 0$): $x = 2x + 1, x \geq 0$

$$\Leftrightarrow -x = 1, x \geq 0$$

$$\Leftrightarrow x = -1, x \geq 0$$

Now, our solution is that $x = -1$, however, we must also satisfy the condition that $x \geq 0$. As both statements do not agree with each other, we conclude that for $x \geq 0$ there is no solution.

Case 2 ($x < 0$): $-x = 2x + 1, x < 0$

$$\Leftrightarrow -3x = 1, x < 0$$

$$\Leftrightarrow x = -\frac{1}{3}, x < 0$$

This time our solution is that $x = -\frac{1}{3}$, and we must also satisfy the condition that $x < 0$.

As both statements agree with each other, we conclude that for $x < 0$ there is a solution.

Namely, $x = -\frac{1}{3}$.

Therefore, $|x| = 2x + 1$ has only one solution, $x = -\frac{1}{3}$.

Notice that unlike Case 1, Case 2 has only one solution.

(b) Using our definition for the absolute value, we have:

1. $|x - 1| = x - 1$ if $x - 1 \geq 0$. i.e., $|x - 1| = x - 1$ if $x \geq 1$.

2. $|x - 1| = -(x - 1)$ if $x - 1 < 0$. i.e., $|x - 1| = -(x - 1)$ if $x < 1$.

Notice we can combine these two expressions into one expression, namely:

$$|x - 1| = \begin{cases} x - 1 & \text{if } x \geq 1 \\ -(x - 1) & \text{if } x < 1 \end{cases} \quad \text{[this is known as a hybrid expression]}$$

Meaning that solving $|x - 1| = x$ is the same as solving $x = \begin{cases} x - 1 & \text{if } x \geq 1 \\ -(x - 1) & \text{if } x < 1 \end{cases}$.

Case 1 ($x \geq 1$):

$$x - 1 = x \text{ if } x \geq 1 \Leftrightarrow -1 = 0 \text{ if } x \geq 1.$$

And so, there is no solution for the case when $x \geq 1$.

Case 2 ($x < 1$):

$$\begin{aligned} -(x-1) = x \text{ if } x < 1 &\Leftrightarrow -x+1 = x \text{ if } x < 1 \\ &\Leftrightarrow 2x = 1 \text{ if } x < 1 \\ &\Leftrightarrow x = \frac{1}{2} \text{ if } x < 1 \end{aligned}$$

Then, as $x = \frac{1}{2}$ lies in the interval $x < 1$, it is a solution.

So, $|x-1| = x \Leftrightarrow x = \frac{1}{2}$.

(c) This time we will reduce the amount of setting out:

$$|3-x| = x-1 \Leftrightarrow \begin{cases} 3-x & \text{if } 3-x \geq 0 \\ -(3-x) & \text{if } 3-x < 0 \end{cases} = x-1 \Leftrightarrow \begin{cases} 3-x & \text{if } 3 \geq x \\ -(3-x) & \text{if } 3 < x \end{cases} = x-1$$

Case 1 ($x \leq 3$): $3-x = x-1, x \leq 3$.

$$\begin{aligned} \Leftrightarrow 4 &= 2x, x \leq 3 \\ \Leftrightarrow x &= 2, x \leq 3 \end{aligned}$$

As $x = 2$ lies in the interval $x \leq 3$, then it is a solution.

Case 2 ($x > 3$): $-(3-x) = x-1, x > 3 \Leftrightarrow -2 = 0, x > 3$.

For which there is no solution.

Therefore, $|3-x| = x-1 \Leftrightarrow x = 2$

Solving Equations with the TI-83

Equations such as those we have just looked at can also be solved using the **solve**(option on the TI-83. We do this by calling up the **Catalogue** and then

1. locating the **solve**(option
2. enter the relevant equation
[The equation must be entered in the form **Equation = 0**. So, to solve the equation $2x + 6 = 15$, we must rewrite it as $2x + 6 - 15 = 0$ so that the equation that is entered into the TI-83 is $2x + 6 - 15 = 0$]
3. indicate the variable we are solving for
4. provide a reasonable guess (for the answer)

To obtain the **solve**(option we use the following sequence:

2nd 0 LN then use the arrow key to reach **solve**(and then press ENTER:

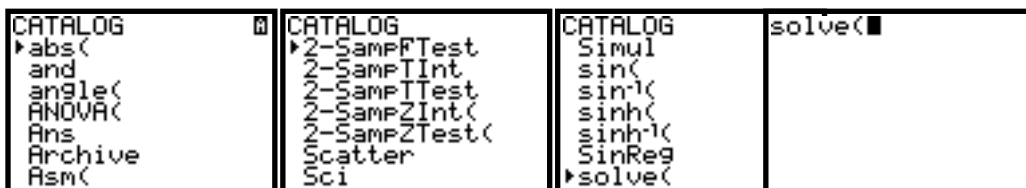

We look at some of the problems we have already solved:

EXAMPLE 2.9

Solve the following linear equations

- (a) $4x + 5 = 21$ (b) $3(5x - 2) = 12$ (c) $\frac{x-3}{2} - 1 = x$
 (d) $|x| = 2x + 1$

S
o
l
u
t
i
o
n

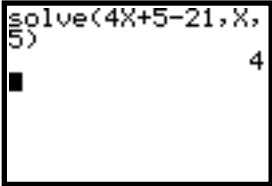
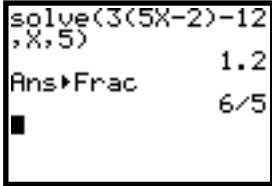
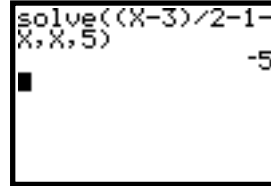
(a)  (b)  (c) 

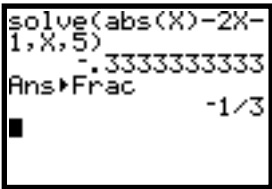
(d) 

Notice that in each case we have used a guess of 5.

Another method is to use the **Equation solver** facility. The expression must still be entered in the form **Equation = 0**. To call up the Equation solver screen

- press **MATH** **0**
- Enter the equation in the form **Equation = 0**
- Move the cursor over the variable for which you want to solve and then press **ALPHA** **ENTER**.

It is important that you become familiar with both modes of solving equations, although eventually you will prefer one method over the other.

EXERCISES 2.2.1

1. Solve the following linear equations.

- (a) $2x = 8$ (b) $5x - 3 = 12$ (c) $2 - \frac{1}{3}x = 4$
 (d) $\frac{3-2x}{7} = 2$ (e) $\frac{5x}{3} + \frac{1}{2} = \frac{2}{3}$ (f) $2x + \frac{1}{4} = 1$

2. Solve the following equations.

- (a) $5(x - 1) = 12$ (b) $3\left(2 - \frac{1}{2}x\right) = 4$ (c) $-2(2x + 1) = 1$
 (d) $2x - 1 = 3 - x$ (e) $3\left(5 - \frac{1}{3}x\right) = x - 20$ (f) $5(2x - 3) = 8 - \frac{1}{4}x$

3. Solve the following equations.

(a) $\frac{2-u}{6} + 8 = 1 - u$ (b) $\frac{u-1}{4} - 3 = \frac{u}{3}$ (c) $\frac{x-2}{3} + 1 = \frac{1-x}{4}$
 (d) $\frac{5}{x+1} + 2 = \frac{1}{x+1}$ (e) $\frac{1}{y-1} + 1 = \frac{2}{y-1}$ (f) $\frac{3(u+1)}{5} - 2 = \frac{(u+1)}{5}$

4. Solve the following equations for x .

(a) $x - b = b - 2$ (b) $a(x - b) = b + a$ (c) $ax = b(a - x)$
 (d) $\frac{x}{a} - a = b$ (e) $\frac{x}{b} - a = \frac{x}{a} - b$ (f) $\frac{1}{a} + \frac{1}{x} = \frac{1}{b}$
 (g) $\frac{b-x}{a+x} = \frac{b+x}{a-x}$ (h) $\frac{1-ax}{b} + \frac{1-bx}{a} = 0$ (i) $\frac{a}{b-x} = \frac{b}{a-x}$

5. Solve for x .

(a) $|2x| = 8$ (b) $|5x - 3| = 12$ (c) $\left|2 - \frac{1}{3}x\right| = 4$
 (d) $\left|\frac{3-2x}{7}\right| = 2$ (e) $\left|\frac{5x}{3} + \frac{1}{2}\right| = \frac{2}{3}$ (f) $\left|2x + \frac{1}{4}\right| = 1$
 (g) $|5(x - 1)| = 12$ (h) $\left|3\left(2 - \frac{1}{2}x\right)\right| = 4$ (i) $\left|\left(\frac{2}{3}x + 1\right)\right| = 1$
 (j) $a - 2|x| = b$ (k) $a - \left|\frac{1}{b}x\right| = b$ (l) $|2ax - b| = 3b$

6. Solve the following equations.

(a) $2x = |x - 1|$ (b) $1 - x = \frac{1}{2}|x|$ (c) $|x + 2| = 3x - 1$
 (d) $\left|1 - \frac{1}{3}x\right| = 2x + 1$ (e) $|1 + 2x| = 2 - x$ (f) $3x + 4 = |3 - x|$

7. Solve the following for x .

(a) $|x + a| = 2x + a, a > 0$ (b) $|2x - a| = 2a - x, a > 0$
 (c) $|2x + a| = |x| - a, a > 0$ (d) $\left|\frac{1}{2}x + a\right| = |x - a|, a > 0$

8. Solve the following for x .

(a) $|x + 1| + |x - 1| = 3$ (b) $|x + 1| - |x - 1| = 2$

9. Make use of your graphics calculator to solve a selection of equations from questions 1 to 8.

2.2.2 LINEAR INEQUATIONS

Inequalities are solved in the same way as equalities, with the exception that when both sides are multiplied or divided by a negative number, the direction of the inequality sign reverses.

EXAMPLE 2.10

Find (a) $\{x : x + 1 < 4\}$ (b) $\{x | 2x - 5 < 1\}$

(a) $x + 1 < 4 \Leftrightarrow x < 3$.

Therefore, the solution set (s.s) is $\{x : x < 3\}$.

(b) $2x - 5 < 1 \Leftrightarrow 2x < 6$
 $\Leftrightarrow x < 3$

Therefore, the solution set (s.s) is $\{x : x < 3\}$.

EXAMPLE 2.11

Find (a) $\{x : x + 2 > 3 - 2x\}$ (b) $\left\{x : \frac{3 - 2x}{7} \leq \frac{4x - 3}{2}\right\}$

(a) $x + 2 > 3 - 2x \Leftrightarrow 3x + 2 > 3$
 $\Leftrightarrow 3x > 1$
 $\Leftrightarrow x > \frac{1}{3}$

Therefore, s.s. = $\left\{x : x > \frac{1}{3}\right\}$

(b) $\frac{3 - 2x}{7} \leq \frac{4x - 3}{2} \Leftrightarrow 14\left(\frac{3 - 2x}{7}\right) \leq 14\left(\frac{4x - 3}{2}\right)$ [multiply both sides by 14]
 $\Leftrightarrow 2(3 - 2x) \leq 7(4x - 3)$
 $\Leftrightarrow 6 - 4x \leq 28x - 21$
 $\Leftrightarrow -32x \leq -27$
 $\Leftrightarrow x \geq \frac{27}{32}$ [notice the reversal of the inequality – as we divided by a negative number]

Therefore, s.s. is $\left\{x : x \geq \frac{27}{32}\right\}$.

When dealing with inequalities that involve absolute values, we need to keep in mind the following:

1. $|x| < a \Leftrightarrow -a < x < a$
2. $|x| > a \Leftrightarrow x < -a$ or $x > a$

EXAMPLE 2.12

Find (a) $\{x : |x + 1| < 4\}$ (b) $\{x : |2x - 5| \leq 1\}$

$$(a) \quad |x + 1| < 4 \Leftrightarrow -4 < x + 1 < 4 \\ \Leftrightarrow -5 < x < 3 \quad \text{[subtracting 1 from both inequalities]}$$

Therefore, s.s. is $\{x : -5 < x < 3\}$.

$$(b) \quad |2x - 5| \leq 1 \Leftrightarrow -1 \leq 2x - 5 \leq 1 \\ \Leftrightarrow 4 \leq 2x \leq 6 \quad \text{[adding 5 to both sides of inequality]} \\ \Leftrightarrow 2 \leq x \leq 3 \quad \text{[dividing both sides by 2]}$$

EXAMPLE 2.13

Find (a) $\left\{x : \left|1 - \frac{1}{2}x\right| > 3\right\}$ (b) $\{x : |3x - 2| - 1 \geq 5\}$

$$(a) \quad \left|1 - \frac{1}{2}x\right| > 3 \Leftrightarrow 1 - \frac{1}{2}x > 3 \text{ or } 1 - \frac{1}{2}x < -3 \\ \Leftrightarrow -\frac{1}{2}x > 2 \text{ or } -\frac{1}{2}x < -4 \\ \Leftrightarrow x < -4 \text{ or } x > 8 \quad \text{[Note the reversal of inequality sign, i.e., } \times \text{ by } -2\text{]}$$

Therefore, s.s. is $\{x : x < -4\} \cup \{x : x > 8\}$.

$$(b) \quad |3x - 2| - 1 \geq 5 \Leftrightarrow |3x - 2| \geq 6 \\ \Leftrightarrow 3x - 2 \geq 6 \text{ or } 3x - 2 \leq -6 \\ \Leftrightarrow 3x \geq 8 \text{ or } 3x \leq -4 \\ \Leftrightarrow x \geq \frac{8}{3} \text{ or } x \leq -\frac{4}{3}$$

Therefore, s.s. is $\left\{x : x \leq -\frac{4}{3}\right\} \cup \left\{x : x \geq \frac{8}{3}\right\}$.

EXAMPLE 2.14

Find $\{x : |x| > 1 - 2x\}$

As with equalities, we need to consider the conditions of the absolute value.

For $x > 0$ we have: $x > 1 - 2x \Leftrightarrow 3x > 1 \Leftrightarrow x > \frac{1}{3}$.

As both conditions are satisfied, i.e., $x > 0$ and $x > \frac{1}{3}$, one s.s. is $\left\{x : x > \frac{1}{3}\right\}$.

For $x < 0$ we have: $-x > 1 - 2x \Leftrightarrow x > 1$.

However, this time the conditions do not agree with each other, i.e., we cannot have the solution $x > 1$ with the restriction that $x < 0$.

Therefore, the only s.s. is $\left\{x : x > \frac{1}{3}\right\}$.

EXERCISES 2.2.2

1. Solve the following inequalities.

(a) $2x + 1 < x - 3$ (b) $\frac{x-4}{3} \geq 2x - 1$ (c) $x + 1 > \frac{x+3}{2}$
 (d) $x \geq 3(x+4)$ (e) $\frac{x-4}{5} > \frac{2-x}{2}$ (f) $1 - 3x < 5x - 2$

2. Solve the following inequalities.

(a) $\frac{2x+1}{5} - \frac{2-x}{3} > 3$ (b) $\frac{1+x}{2} + \frac{1-x}{4} \leq 1$ (c) $\frac{x}{5} + \frac{2-3x}{3} \geq -2$

3. Solve the following inequalities.

(a) $a(x+1) > 2a, a < 0$ (b) $\frac{a-x}{2} + 1 > a, a > 0$
 (c) $\frac{x}{a} + \frac{b}{a^2} < \frac{4x}{a} - \frac{b}{a^2}, b > a > 0$ (d) $x + \frac{x-1}{a+1} \geq \frac{x+1}{a+1} - ax, a > 0$

4. Solve the following inequalities.

(a) $|4x + 2| \leq 6$ (b) $|2x - 1| \leq 5$ (c) $|4x - 2| \leq 8$
 (d) $|4x + 2| \leq 0$ (e) $|x - 1| \leq 8$ (f) $|3x + 3| \leq 12$
 (g) $\left|3 - \frac{x}{2}\right| \leq 5$ (h) $\left|2 - \frac{x}{4}\right| \leq 9$ (i) $\left|3x + \frac{1}{2}\right| \leq \frac{3}{4}$

5. Solve the following inequalities.

(a) $|2x - 1| > 4$ (b) $|5 - 2x| > 2$ (c) $\left|1 - \frac{x}{2}\right| \geq 7$
 (d) $\left|3 + \frac{1}{3}x\right| \geq 5$ (e) $3|6 - 4x| + 1 > 10$ (f) $12 - |4 - x| > 2$
 (g) $\left|2 - \frac{x}{4}\right| > 9$ (h) $\left|3x + \frac{1}{2}\right| > \frac{3}{4}$ (i) $\left|3 - \frac{x}{2}\right| \geq 5$

6. For what value(s) of p does $\left|\frac{3x}{2} - 7\right| \leq p - 3$ have no solutions?

7. Solve the following inequalities.

(a) $\frac{1}{2}x + 1 > |x|$ (b) $3 - x \geq |2x|$ (c) $|2x - 1| < x + 1$

8. Solve the following inequalities where $0 < a < 1$.

(a) $ax > |x - a|$ (b) $|x| < ax + 1$ (c) $\left|\frac{x}{a}\right| \geq x + a$

9. Find (a) $\{x : 4 - |x| > |2x|\}$ (b) $\left\{x : \left|\frac{1}{3}x - 1\right| > |x|\right\}$.

2.3 LINEAR FUNCTIONS

2.3.1 GRAPH OF THE LINEAR FUNCTION

The study of functions and relations is dealt with in detail in Chapter 5, however, we give a basic definition of the term function at this point.

A **function** $y = f(x)$ is an algebraic expression that will generate only one value of y for any one value of x .

For example, if $x = 5$, then $f(5)$ will only generate one value of y . Consider the function $f(x) = x + 3$ then, $f(5) = 5 + 3 = 8$. i.e., only one y -value has been generated.

A **linear function** has the form

$$y = f(x) = mx + c$$

Its graph is a straight line such that

1. m is the slope of the line.
2. c is the y -intercept (i.e., where the line cuts the y -axis).

There are three possible outcomes when a linear function is graphed:

Case 1: $m > 0$

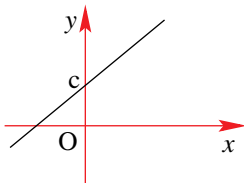

Case 2: $m < 0$

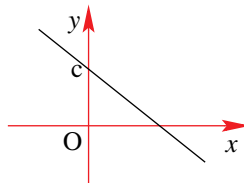

Case 3: $m = 0$

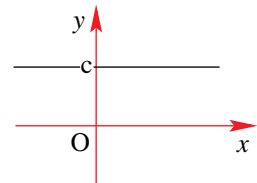

However, sometimes the linear function is expressed in different forms. The reason is that it is sometimes more convenient to express it in a form other than the standard form. For example, the following linear functions are all the same:

$$f(x) = 5x - 2, \quad y = 5x - 2, \quad y + 2 = 5x, \quad -5x + y + 2 = 0$$

They have simply been rewritten into different formats.

EXAMPLE 2.15

Sketch the graphs of the following linear functions.

(a) $f(x) = 2x + 1$

(b) $y = 3 - \frac{1}{2}x$

(c) $4x - 2y = 5$

S
o
l
u
t
i
o
n

- (a) The function $f(x) = 2x + 1$ represents a straight line with a gradient of 2 and a y -intercept of 1. i.e., the graph will cut the y -axis at the point $(0, 1)$. The x -intercept is obtained by solving $f(x) = 0$:
 $2x + 1 = 0 \Leftrightarrow 2x = -1 \Leftrightarrow x = -0.5$.

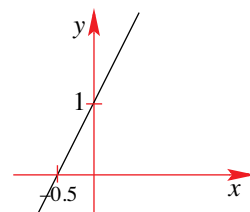

(b) The function $y = 3 - \frac{1}{2}x$ represents a straight line

with a gradient of $-\frac{1}{2}$ and a y-intercept of 3.

i.e., the graph will cut the y-axis at the point (0, 3).

The x-intercept is obtained by solving $y = 0$:

$$3 - \frac{1}{2}x = 0 \Leftrightarrow -\frac{1}{2}x = -3 \Leftrightarrow x = 6 .$$

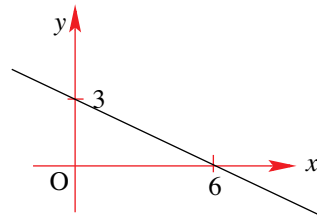

(c) We first rewrite the equation $4x - 2y = 5$:

$$4x - 2y = 5 \Leftrightarrow 2y = 4x - 5 \Leftrightarrow y = 2x - \frac{5}{2} .$$

So, we have a straight line with gradient 2 and y-intercept at -2.5 .

The x-intercept is obtained by solving $y = 0$.

Using the original equation we have

$$4x - 2(0) = 5 \Leftrightarrow x = \frac{5}{4} = 1.25$$

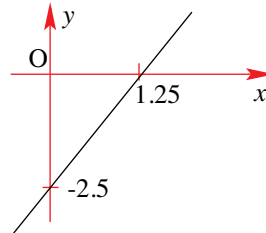

Geometrical interpretation of solving equations

It is interesting to note that although we have been solving equations like $2x + 1 = 7$, we had not provided (apart from using the real number line) a geometrical representation corresponding to the equation. We can now provide such an interpretation.

Solving $2x + 1 = 7$ for x , is the same as considering the function $f(x) = 2x + 1$ and then asking the question:

“When will the straight line $y = 2x + 1$ have a y-value of 7”.

Or,

“When will the straight line $y = 2x + 1$ meet the straight line $y = 7$ ”.

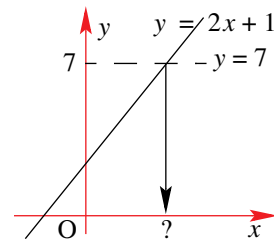

In general we have the following geometrical interpretation for any equation.

Solving $f(x) = k$ for x is equivalent to finding the x -value where the graphs of $y = f(x)$ and $y = k$ intersect.

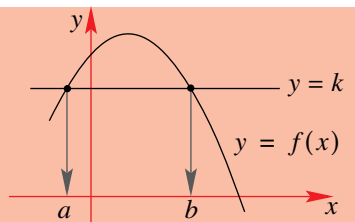

Note that although with linear equations there will only be one solution, for non-linear functions there may very well be more than one solution.

We complete this section by providing a summary of other properties of straight lines:

Properties of straight lines

1. Gradient of a line

The gradient, m , of the line through two points (x_1, y_1)

and (x_2, y_2) is given by $m = \frac{y_2 - y_1}{x_2 - x_1}$ or $m = \frac{\text{Rise}}{\text{Run}}$

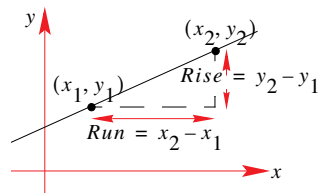

From this we can obtain the point–gradient form of a line.

That is, if (x, y) is any point on a straight line having a gradient m , and (x_1, y_1) is another fixed point on that line then the equation of that line is given by

$$y - y_1 = m(x - x_1)$$

2. Parallel lines

The straight line l_1 with gradient m_1 is parallel to the straight line l_2 with gradient m_2 if and only if $m_1 = m_2$.

That is,

$$l_1 \parallel l_2 \text{ iff } m_1 = m_2$$

Notice that if the two lines are parallel, they also make equal angles with the x -axis.

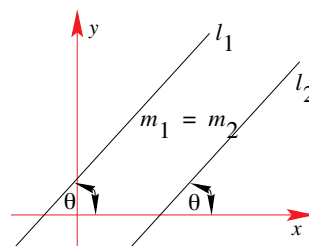

3. Perpendicular lines

The straight line l_1 with gradient m_1 is perpendicular to the straight line l_2 with gradient m_2 if and only if $m_1 \times m_2 = -1$.

That is,

$$l_1 \perp l_2 \text{ iff } m_1 \times m_2 = -1 \text{ or } m_1 = -\frac{1}{m_2}$$

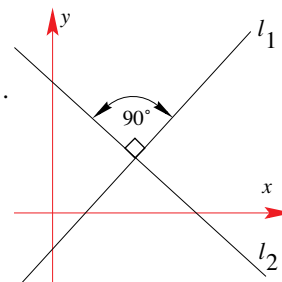

EXAMPLE 2.16

Find the equation of the line that passes through the point $(-1, 3)$ and is parallel to the line with equation $2x - y + 7 = 0$.

S
o
l
u
t
i
o
n

The gradient of the line $2x - y + 7 = 0$ is found by rearranging to the form $y = mx + c$ to get: $y = 2x + 7$. The gradient is 2 and so all the lines parallel to this will also have gradient 2. The equation of the required line is $y = 2x + c$. The value of the constant c can be found by using the fact that the line passes through the point $(-1, 3)$.

That is, $y = 2x + c \therefore 3 = 2 \times -1 + c \Leftrightarrow c = 5$

Therefore the equation of the straight line is $y = 2x + 5$.

EXAMPLE 2.17

Find the equation of the line which passes through the point $(-1, 4)$ and which is perpendicular to the line with equation $2x + 5y + 2 = 0$.

Solution
 The gradient form of $2x + 5y + 2 = 0$ is $5y = -2x - 2 \Rightarrow y = -\frac{2}{5}x - \frac{2}{5}$.
 So the gradient is $-\frac{2}{5}$. The gradient of all lines perpendicular to this line is found using the fact that the product of the gradients of perpendicular lines is -1 : $\left(-\frac{2}{5}\right)m = -1 \Rightarrow m = \frac{5}{2} = 2.5$.
 Then, the equation of the line is $y = \frac{5}{2}x + c$. The constant c is found in the same way as the previous example: Using the point $(-1, 4)$ we have $4 = \frac{5}{2} \times -1 + c \Leftrightarrow c = 6.5$.
 Therefore the equation of the straight line is $y = \frac{5}{2}x + 6\frac{1}{2}$.

EXERCISES 2.3.1

1. Sketch the graph of the following straight lines.

(i) $y = x + 1$	(ii) $f(x) = x - 2$	(iii) $y = 2x - 3$
(iv) $f(x) = 2 - 3x$	(v) $y = \frac{x+1}{2}$	(vi) $f(x) = 3 + 4x$
(vii) $x + f(x) = 3$	(viii) $x + 2y = 4$	(ix) $x - 3y = 6$
(x) $\frac{x}{2} + \frac{y}{5} = 1$	(xi) $x - \frac{y}{3} = 1$	(xii) $\frac{2x}{5} - 3y = 2$
(xiii) $x + \frac{5y}{4} = -1$	(xiv) $\frac{4+t}{2} = q$	(xv) $x + 4y = 2 - x$

2. Find the gradient of the line joining the points

(a) $(3, 2)$ and $(5, 6)$	(b) $(4, 5)$ and $(6, 11)$	(c) $(-1, 3)$ and $(2, 8)$
---------------------------	----------------------------	----------------------------

3. Use the gradient–point method to find the equation of the straight line if

(a) it passes through the point $(1, 1)$ and has a gradient of 2.
(b) it passes through the point $(-2, 3)$ and has a gradient of 3.
(c) it passes through the point $(3, -4)$ and has a gradient of -1 .

4. Find the gradient of the straight line that is perpendicular to the straight line with gradient equal to

(a) 2.	(b) -3 .	(c) $-\frac{2}{3}$.	(d) $\frac{5}{4}$
--------	------------	----------------------	-------------------

5. Find the equation of the straight line that passes through the origin and the point $(2, 4)$.
6. Find the equation of the straight line that passes through the points $(-1, 2)$ and $(0, 1)$.
7. A straight line passes through the point $(4, 3)$ and is perpendicular to the line joining the points $(-1, 3)$ and $(1, -1)$. Find the equation of this line.

- 8.** The lines $px + 4y - 2 = 0$ and $2x - y + p = 0$ are perpendicular. Find the value of p .
- 9.** Find equations for each of the following lines.

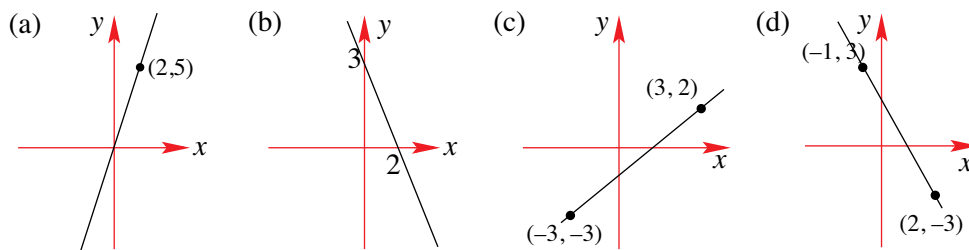

- 10.** Sketch the graph of the following functions.
- (a) $f(x) = ax - b, a < 0, b > 0$ (b) $f(x) = a^2x + b, b < 0, a \neq 0$
- (c) $f(x) = \frac{a}{a+1}x - a, a > 0$ (d) $f(x) = 2a + \frac{1}{a}x, a > 0$

2.3.2 SIMULTANEOUS LINEAR EQUATIONS IN TWO UNKNOWNNS

Pairs of simultaneous equations in two unknowns may be solved in two ways, either algebraically or graphically. To solve means to find where the two straight lines intersect once they have been sketched. So, we are looking for the point of intersection.

Method 1: Graphical

EXAMPLE 2.18

Solve the system of linear equations $y = -x + 7$ and $y = 2x + 1$.

- S** We sketch both lines on the same set of axes:
- o**
- i** Reading off the grid we can see that the straight lines
- t** meet at the point with coordinates (2, 5).
- i**
- o** So, the solution to the given system of equations is
- n** $x = 2$ and $y = 5$.

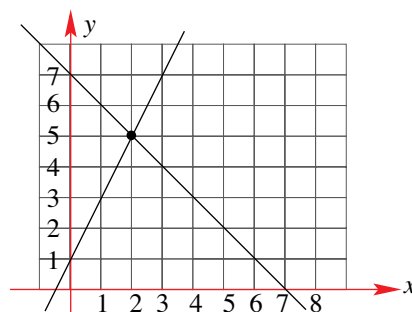

The graphical approach has a disadvantage. Sometimes it can only provide an approximate answer. This depends on the accuracy of the sketch or simply on the equations, for example, sketching the pair of straight lines with equations $y = \sqrt{2}x - 1$ and $y = -x + \sqrt{3}$ can only result in an approximate solution.

Then there is the graphics calculator. There are a number of ways that the graphics calculator can be used. Using the TI-83 we can make use of the **TRACE** function or the **intersection** option

MATHEMATICS – Higher Level (Core)

under the **CALC** menu. We solve the previous problem using the intersection option from the **CALC** menu.

- Step 1:** Enter both equations in the required form, i.e., $y = \dots$
- Step 2:** Choose an appropriate window setting, in this case we have $[-2,8]$ by $[-1,8]$.
- Step 3:** Sketch the straight lines using the **GRAPH** key.
- Step 4:** Call up the **CALC** menu (i.e., press **2nd TRACE**) and choose option **5: intersect**.
- Step 5:**
- 5.1 Move the cursor to where the lines intersect and press **ENTER** – this confirms that you have selected your first equation.
 - 5.2 Press **ENTER** again, this confirms that you are using the second equation.
 - 5.3 Because you have already placed your cursor near the point of intersection, when prompted to Guess? simple press **ENTER**.

Step 1:

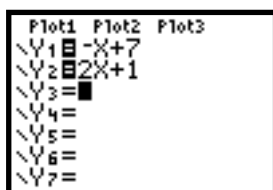

Step 2:

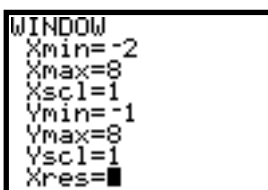

Step 3:

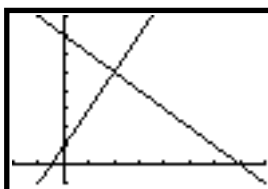

Step 4:



Step 5.1:

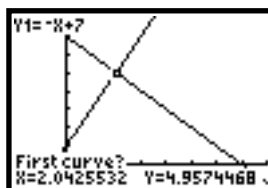

Step 5.2:

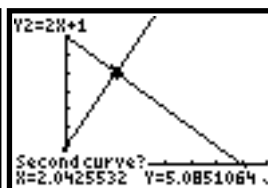

Step 5.3:

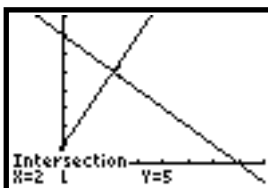
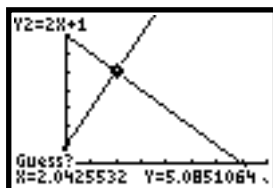

The final screen shows the solution as $x = 2$ and $y = 5$.

This particular example worked out rather neatly, however, the solution of the pairs of equations $y = \sqrt{2}x - 1$ and $y = -x + \sqrt{3}$ would produce the following result:



i.e., we only obtain an approximate solution!

The exact solution is in fact $x = \sqrt{6} + \sqrt{2} - \sqrt{3} - 1$, $y = 2\sqrt{3} + 1 - \sqrt{6} - \sqrt{2}$.

Of course, depending on the application, an approximate solution might suffice. However, at this stage we are interested in the mathematical process. Because we cannot always obtain an exact answer using a graphical means we need to consider an algebraic approach.

Method 2: Algebraic

There are two possible approaches when dealing with simultaneous equations algebraically. They are the process of

- a. **Elimination**
- b. **Substitution**

Elimination Method

The **key step** in using the elimination method is to obtain, for one of the variables (in both equations), coefficients that are the same (or only differ in sign). Then:

if the coefficients are the same, you subtract one equation from the other – this will **eliminate** one of the variables – leaving you with only one unknown.

However,

if the coefficients only differ in sign, you add the two equations – this will **eliminate** one of the variables – leaving you with only one unknown.

EXAMPLE 2.19

Use the elimination method to solve

$$\begin{aligned} x - 2y &= -7 \\ 2x + 3y &= 0 \end{aligned}$$

S
o
l
u
t
i
o
n

As it is easier to add than subtract, we try to eliminate the variable which differs in sign. In this case the variable ‘y’ is appropriate. However, the coefficients still need to be manipulated. We label the equations as follows:

$$\begin{aligned} x - 2y &= -7 && \text{--- (1)} \\ 2x + 3y &= 0 && \text{--- (2)} \\ 3 \times (1): & && \\ 3x - 6y &= -21 && \text{--- (3)} \\ 2 \times (2): & && \\ 4x + 6y &= 0 && \text{--- (4)} \\ \text{Adding (3) + (4):} & && \\ 7x + 0 &= -21 && \\ \Leftrightarrow x &= -3 && \end{aligned}$$

Substituting into (1) we can now obtain the y-value: $-3 - 2y = -7 \Leftrightarrow -2y = -4 \Leftrightarrow y = 2$.
Therefore, the solution is $x = -3, y = 2$.

Once you have found the solution, always check with one of the original equations.

Using equation (2) we have: L.H.S = $2 \times -3 + 3 \times 2 = 0 =$ R.H.S.

Note that we could also have multiplied equation (1) by 2 and then subtracted the result from equation (2). Either way, we have the same answer.

Substitution Method

The substitution method relies on making one of the variables the subject of one of the equations. Then we substitute this equation for its counterpart in the other equation. This will then produce a new equation that involves only one unknown. We can solve for this unknown and then substitute its value back into the first equation. This will then provide a solution pair.

EXAMPLE 2.20

Use the substitution method to solve $5x - y = 4$
 $x + 3y = 4$

S
O
L
I
T
I
O
N

Label the equations as follows: $5x - y = 4$ – (1)

$$x + 3y = 4$$
 – (2)

From equation (1) we have that $y = 5x - 4$ – (3)

Substituting (3) into (2) we have: $x + 3(5x - 4) = 4$

$$\Leftrightarrow 16x - 12 = 4$$

$$\Leftrightarrow 16x = 16$$

$$\Leftrightarrow x = 1$$

Substituting $x = 1$ into equation (3) we have: $y = 5 \times 1 - 4 = 1$.

Therefore, the solution is given by $x = 1$ and $y = 1$.

Check: Using equation (2) we have: L.H.S = $1 + 3 \times 1 = 4 =$ R.H.S

Not all simultaneous equations have unique solutions. Some pairs of equations have no solutions while others have infinite solution sets. You will need to be able to recognise the ‘problem’ in the processes of both algebraic and graphical solutions when dealing with such equations.

The following examples illustrate these possibilities:

EXAMPLE 2.21

Solve: (a) $2x + 6y = 8$
 $3x + 9y = 12$ (b) $2x + 6y = 8$
 $3x + 9y = 15$

S
O
L
I
T
I
O
N

(a) Algebraic solution:

Label the equations as follows:

$$2x + 6y = 8$$
 – (1)

$$3x + 9y = 12$$
 – (2)

$$3 \times (1): 6x + 18y = 24$$
 – (3)

$$2 \times (2): 6x + 18y = 24$$
 – (4)

Graphical Solution:

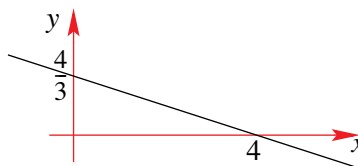

In this case, we have the same equation. That is, the straight lines are **coincident**.

If we were to ‘blindly’ continue with the solution process, we would have:

$$3 \times (1) - 2 \times (2): 0 = 0!$$

The algebraic method produces an equation that is always true, i.e., zero will always equal zero. This means that any pair of numbers that satisfy either equation will satisfy both and are, therefore, solutions to the problem. Examples of solutions are: $x = 4, y = 0, x = 1, y = 1$ & $x = 7, y = -1$. In this case we say that there is an **infinite** number of solutions.

Graphically, the two equations produce the same line. The coordinates of any point on this line will be solutions to both equations.

(a) Algebraic solution:

Label the equations as follows:

$$2x + 6y = 8 \quad \text{--- (1)}$$

$$3x + 9y = 15 \quad \text{--- (2)}$$

$$3 \times \text{(1)}: \quad 6x + 18y = 24 \quad \text{--- (3)}$$

$$2 \times \text{(2)}: \quad 6x + 18y = 30 \quad \text{--- (4)}$$

$$\text{(4)} - \text{(3)}: \quad 0 = 6$$

Graphical Solution:

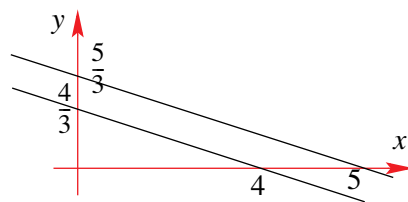

The algebraic method produces an equation that is never true. This means that there are no solutions to the equations.

Graphically, the two lines are parallel and produce no points of intersection.

There is a **matrix** method for solving systems of simultaneous equations that will be discussed in Chapter 25. This method is particularly useful when using graphics calculators which can perform the matrix arithmetic necessary to solve simultaneous equations.

EXERCISES 2.3.2

1. Solve these simultaneous equations, giving exact answers.

(i) $3x - 2y = -1$	(ii) $3x + 5y = 34$	(iii) $2x + 4y = 6$
$5x + 2y = 9$	$3x + 7y = 44$	$4x - 3y = -10$

(iv) $3x + 2y = 2$	(v) $5x + 4y = -22$	(vi) $5x - 9y = -34$
$2x - 6y = -6$	$3x - y = -3$	$2x + 3y = -7$

2. Solve these simultaneous equations, giving fractional answers where appropriate.

(i) $3x - y = 2$	(ii) $4x + 2y = 3$	(iii) $-3x + y = 0$
$5x + 2y = 9$	$x - 3y = 0$	$2x - 4y = 0$

(iv) $\frac{x}{2} - 3y = 4$	(v) $5x + \frac{2y}{3} = -4$	(vi) $\frac{3x}{5} - 4y = \frac{1}{2}$
$4x + \frac{3y}{2} = -1$	$4x + y = 2$	$x - 2y = \frac{1}{3}$

3. Find the values of m such that these equations have no solutions.

(i) $3x - my = 4$	(ii) $5x + y = 12$	(iii) $4x - 2y = 12$
$x + y = 12$	$mx - y = -2$	$3x + my = 2$

4. Find the values of m and a such that these equations have infinite solution sets.

(i) $4x + my = a$	(ii) $5x + 2y = 12$	(iii) $3x + my = a$
$2x + y = 4$	$mx + 4y = a$	$2x - 4y = 6$

5. Find the solution sets of the following simultaneous equations, solving for x and y .

(a)	$bx + y = a$	(b)	$bx + y = a$	(c)	$ax + by = 1$
	$ax - y = b$		$ax + y = b$		$ax - by = 1$
(d)	$ax + y = ab$	(e)	$ax + by = a - b$	(f)	$ax + y = b$
	$bx - y = b^2$		$bx + ay = a - b$		$bx + ay = 2ab - a^3$

2.3.3 SIMULTANEOUS LINEAR EQUATIONS IN THREE UNKNOWNNS

So far we have looked at linear equation in two unknowns. However, this can be extended to linear equations in three unknowns. Equations such as these, involving the variables x , y and z take on the general form $ax + by + cz = k$ where a , b , c and k are real constants.

Just as for the case with two unknowns, where we required two equations to (hopefully) obtain a unique solution to the system of simultaneous equations, when dealing with three unknowns we will require a minimum of three equations to (hopefully) obtain a unique solution.

The solution process for a system of linear equations in three unknowns will require, primarily, the use of the elimination method. The method usually involves the reduction of a system of three equations in three unknowns to one of two equations in two unknowns. This will then enable the use of the methods already discussed to solve the ‘reduced’ system. Once two of the unknowns have been determined from this ‘reduced’ system, we substitute back into one of the original three equations to solve for the third unknown.

EXAMPLE 2.21

$$\begin{aligned} x + 3y - z &= 13 \\ \text{Solve the simultaneous equations } 3x + y - z &= 11 \\ x + y - 3z &= 11 \end{aligned}$$

S
o
l
u
t
i
o
n

We label the equations as follows;

$$\begin{aligned} x + 3y - z &= 13 && \text{(1)} \\ 3x + y - z &= 11 && \text{(2)} \\ x + y - 3z &= 11 && \text{(3)} \end{aligned}$$

Step 1: Reduce the system to one involving two equations and two unknowns.
We first eliminate the variable z :

$$\begin{aligned} (2) - (1): \quad 2x - 2y &= -2 && \text{(4)} \\ 3 \times (2) - (3): \quad 8x + 2y &= 22 && \text{(5)} \end{aligned}$$

Step 2: Solve the reduced system of equations.

$$\begin{aligned} (4) + (5): \quad 10x &= 20 \\ \Leftrightarrow x &= 2 \end{aligned}$$

Substitute into (5): $2 \times 2 - 2y = -2 \Leftrightarrow -2y = -6 \Leftrightarrow y = 3$.

Step 3: Solve for the third unknown.

Substituting $x = 2$ and $y = 3$ into (1):

$$2 + 3 \times 3 - z = 13 \Leftrightarrow z = -2$$

Therefore the solution is given by $x = 2$, $y = 3$ and $z = -2$.

Check: Using equation (2): L.H.S. = $2 + 3 - 3 \times -2 = 11 =$ R.H.S

We have already seen that linear equations in two unknowns are represented by straight lines on the Cartesian axes. The question then becomes, “What do linear equations in three unknowns look like?”

Equations of the form $ax + by + cz = k$ represent a plane in space. To draw such a plane we need to set up three mutually perpendicular axes that coincide at some origin O . This is commonly drawn with a horizontal x - y plane and the z -axis in the vertical direction:

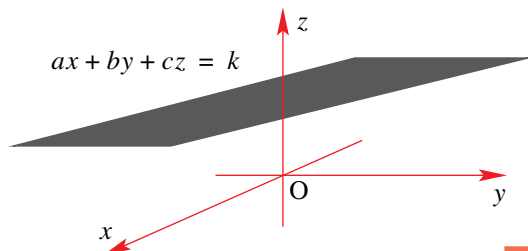

In Example 2.21 we obtained a unique solution. This means that the three planes must have intersected at a unique point. We can represent such a solution as shown in the diagram alongside:

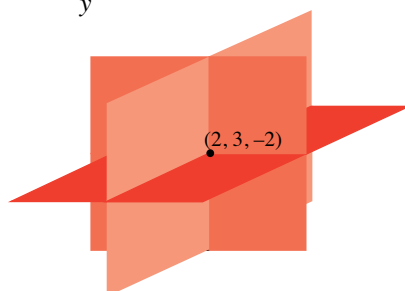

There are a number of possible combinations for how three planes in space can intersect (or not). Labelling the planes as α , β and γ the possible outcomes are shown below.

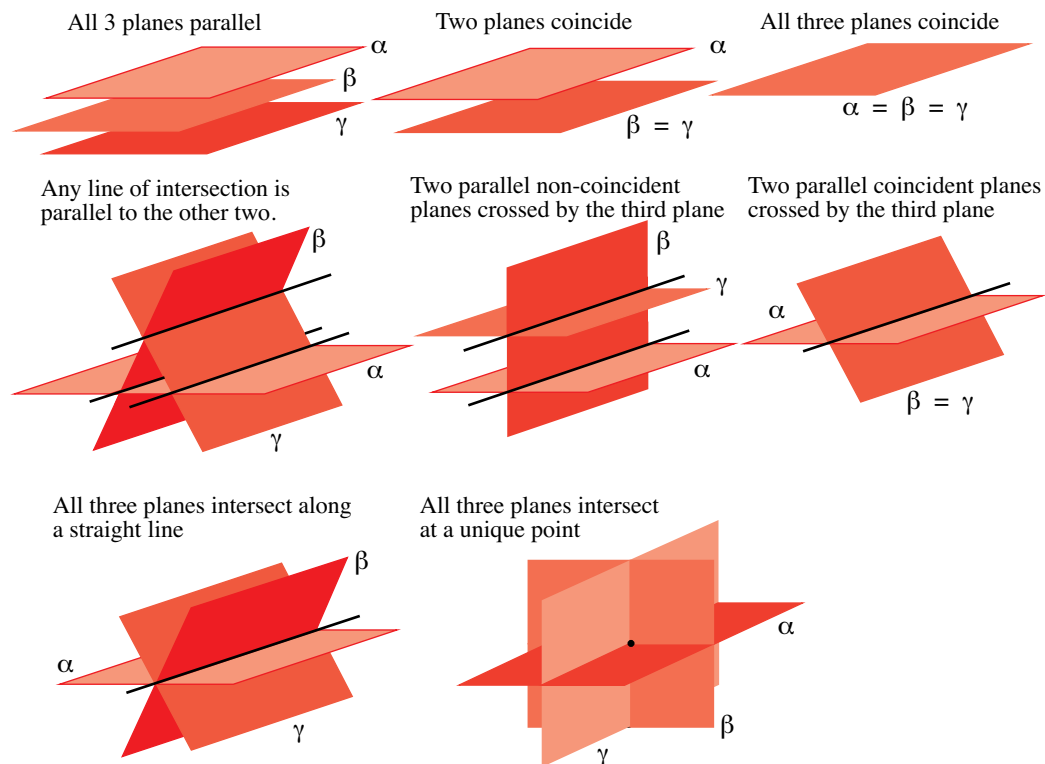

EXAMPLE 2.22

$$\begin{aligned} & x + 2y = 10 \\ \text{Solve the simultaneous equations } & 3x + 2y - 4z = 18 \\ & y + z = 3 \end{aligned}$$

S
o
l
u
t
i
o
n

We label the equations as follows;

$$\begin{aligned} x + 2y &= 10 && - (1) \\ 3x + 2y - 4z &= 18 && - (2) \\ y + z &= 3 && - (3) \end{aligned}$$

We eliminate x using equations (1) and (2):

$$\begin{aligned} (2) - 3 \times (1): & \quad -4y - 4z = -12 \\ \Leftrightarrow y + z &= 3 - (4) \end{aligned}$$

We are now left with equations (3) and (4). However, these two equations are identical.

To obtain the solution set to this problem we introduce a **parameter**, we let z be any arbitrary value, say $z = k$ where k is some real number.

Then, substituting into equation (4), we have:

$$y + k = 3 \Rightarrow y = 3 - k.$$

Next, we substitute into (1) so that

$$x + 2(3 - k) = 10 \Rightarrow x = 4 + 2k.$$

Therefore, the solution is given by, $x = 4 + 2k, y = 3 - k, z = k$.

Notice the nature of the solution, each of the variables is expressed as a linear function of k . This means that we have a situation where the three original planes meet along a straight line.

EXERCISES 2.3.3

1. Solve the simultaneous equations

	$6x + 4y - z = 3$		$x + y + z = 2$
(a)	$x + 2y + 4z = -2$	(b)	$4x + y = 4$
	$5x + 4y = 0$		$-x + 3y + 2z = 8$
	$4x + 9y + 13z = 3$		$x - 2y - 3z = 3$
(c)	$-x + 3y + 24z = 17$	(d)	$x + y - 2z = 7$
	$2x + 6y + 14z = 6$		$2x - 3y - 2z = 0$
	$x - y - z = 2$		$x - 2y = -1$
(e)	$3x + 3y - 7z = 7$	(f)	$-x - y + 3z = 1$
	$x + 2y - 3z = 3$		$y - z = 0$
	$x + y + z = 1$		$-2x + y - 2z = 5$
(g)	$x - y + z = 3$	(h)	$x + 4z = 1$
	$4x + 2y + z = 6$		$x + y + 10z = 10$

2.4 QUADRATICS

2.4.1 QUADRATIC EQUATION

A **quadratic equation** in the **variable** x (say) takes on the form $ax^2 + bx + c = 0$ where a, b and c are real constants. The equation is a quadratic because x is raised to the power of two. The solution(s) to such equations can be obtained in one of two ways.

Method 1: Factorise the quadratic and use the Null Factor Law.

Method 2: Use the quadratic formula.

We look at each of these methods.

Method 1 Factorisation and the Null Factor Law

First of all we must have one side of the equation as 0, otherwise the Null Factor Law cannot be used. Next, when factorising the quadratic, you will need to rely on your ability to recognise the form of the quadratic and hence which approach to use. A summary of the factorisation process for quadratics is shown below:

Case 1: $a = 1$

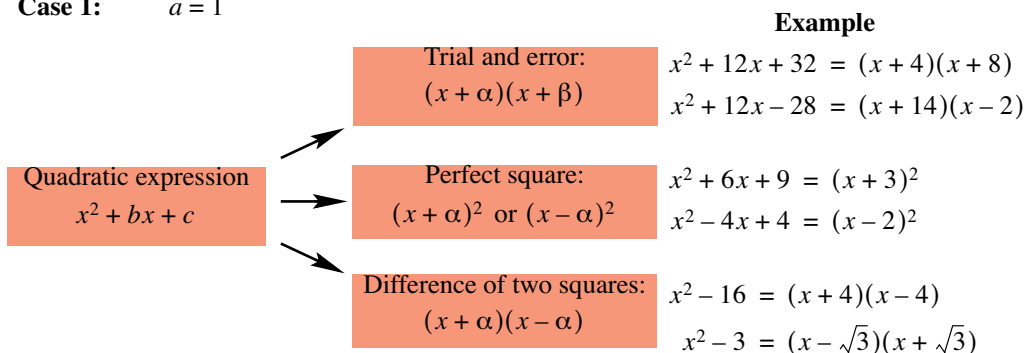

Note that sometimes you might need to use a perfect square approach to part of the quadratic and then complete the factorisation process by using the difference of two squares.

EXAMPLE 2.23

Solve the quadratic $x^2 + 6x + 7 = 0$

S
o
l
u
t
i
o
n

In this instance it is not obvious what the factors are and so trial and error is not appropriate.

However, we notice that $x^2 + 6x + 7$ can be ‘broken up’ into $x^2 + 6x + 9 - 2$.

That is, part of the quadratic has been expressed as a perfect square, so that

$$x^2 + 6x + 9 - 2 = (x + 3)^2 - 2$$

Then, we are left with a difference of perfect squares: $(x + 3)^2 - 2 = (x + 3 + \sqrt{2})(x + 3 - \sqrt{2})$.

Therefore, $x^2 + 6x + 7 = 0 \Leftrightarrow (x + 3 + \sqrt{2})(x + 3 - \sqrt{2}) = 0 \Leftrightarrow x = -3 \pm \sqrt{2}$.

Case 2: $a \neq 1$

Example

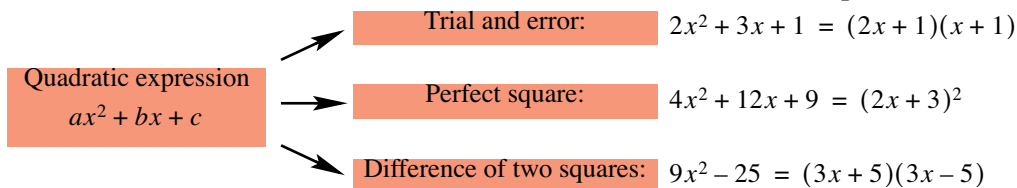

That is, the methods for the case $a \neq 1$ are the same as for when $a = 1$, they require a little more mental arithmetic to ‘juggle’ the correct numbers. Sometimes they can get messy, as the next example shows.

EXAMPLE 2.24

Solve the quadratic $3x^2 + 2x - 2 = 0$.

Solution

None of the above methods provides a quick solution, so, as for Example 2.23, we will combine the methods of perfect squares with the difference of two squares:

$$\begin{aligned}
 3x^2 + 2x - 2 &= 3\left(x^2 + \frac{2}{3}x\right) - 2 = 3\left(x^2 + \frac{2}{3}x + \frac{1}{9}\right) - 3 \times \frac{1}{9} - 2 \text{ [add and subtract } \frac{3}{9}] \\
 &= 3\left(x + \frac{1}{3}\right)^2 - \frac{7}{3}
 \end{aligned}$$

Part of the quadratic is now a perfect square. Next, we use the difference of perfect squares:

$$\begin{aligned}
 &= 3\left(x + \frac{1}{3}\right)^2 - \frac{7}{3} \\
 &= 3\left[\left(x + \frac{1}{3}\right)^2 - \frac{7}{9}\right] \\
 &= 3\left(x + \frac{1}{3} - \frac{\sqrt{7}}{3}\right)\left(x + \frac{1}{3} + \frac{\sqrt{7}}{3}\right)
 \end{aligned}$$

Therefore, $3x^2 + 2x - 2 = 0 \Leftrightarrow 3\left(x + \frac{1}{3} - \frac{\sqrt{7}}{3}\right)\left(x + \frac{1}{3} + \frac{\sqrt{7}}{3}\right) = 0 \Leftrightarrow x = -\frac{1}{3} \pm \frac{\sqrt{7}}{3}$.

Now, that was quite a bit of work!

Of course, coming up with the ‘magic’ number, $\frac{1}{9}$ did make life a little easier. The rest was simply being careful with the arithmetic. So, how did we pull $\frac{1}{9}$ out of the hat? Well, once we have made the coefficient of the x^2 one, i.e., by factorising the ‘3’ out, we look at the coefficient of the x term. Then we halve it, square the result and add it. i.e., $\frac{1}{2} \times \frac{2}{3} = \frac{1}{3} \rightarrow \left(\frac{1}{3}\right)^2 = \frac{1}{9}$.

Then, so that the equation is unaltered, we subtract this result – but be careful, do not forget to multiply it by the factor ‘3’ at the front of the brackets. The rest then follows.

The only way to be proficient with these methods is practice, practice and more practice. However, there is a short cut to solving quadratic equations. We look at this next.

Method 2 Quadratic Formula and the Discriminant

A formula that allows us to solve any quadratic equation $ax^2 + bx + c = 0$ (if real solutions exist), is given by $x = \frac{-b \pm \sqrt{b^2 - 4ac}}{2a}$. So that obtaining solutions requires that we make the appropriate substitution for a , b and c .

To derive this expression we proceed in exactly the same way as we did in Example 2.24. We show some of the key steps in obtaining this result and leave the proof for you to complete.

$$\begin{aligned} ax^2 + bx + c &= a\left(x^2 + \frac{b}{a}x\right) + c = a\left[\left(x^2 + \frac{b}{a}x + \frac{b^2}{4a^2}\right)\right] - a \times \frac{b^2}{4a^2} + c \\ &= a\left(x + \frac{b}{2a}\right)^2 - a\left(\frac{b^2}{4a^2} - \frac{c}{a}\right) \\ &= a\left[\left(x + \frac{b}{2a}\right)^2 - \left(\frac{b^2 - 4ac}{4a^2}\right)\right] \\ &= a\left(x + \frac{b + \sqrt{b^2 - 4ac}}{2a}\right)\left(x + \frac{b - \sqrt{b^2 - 4ac}}{2a}\right) \end{aligned}$$

Therefore, $ax^2 + bx + c = 0 \Leftrightarrow x = \frac{-b \pm \sqrt{b^2 - 4ac}}{2a}$.

EXAMPLE 2.25

Use the formula to solve the quadratic equations:

(a) $x^2 - x - 4 = 0$ (b) $2x^2 = 4 - x$

S
o
l
u
t
i
o
n

(a) For the equation $x^2 - x - 4 = 0$, we have $a = 1$, $b = -1$ & $c = -4$,

$$\begin{aligned} x &= \frac{-b \pm \sqrt{b^2 - 4ac}}{2a} \\ &= \frac{1 \pm \sqrt{(-1)^2 - 4 \times 1 \times -4}}{2 \times 1} \\ &= \frac{1 \pm \sqrt{17}}{2} \end{aligned}$$

(b) Similarly, if $2x^2 = 4 - x$, then,

$$\begin{aligned} 2x^2 + x - 4 &= 0 \\ \text{so that } a &= 2, b = 1 \text{ and } c = -4, \text{ so that} \\ x &= \frac{-b \pm \sqrt{b^2 - 4ac}}{2a} \\ &= \frac{-1 \pm \sqrt{(-1)^2 - 4 \times 2 \times -4}}{2 \times 2} \\ &= \frac{-1 \pm \sqrt{33}}{4} \end{aligned}$$

The Discriminant

Closer inspection of this formula indicates that much can be deduced from the term under the square root sign, i.e., $b^2 - 4ac$. The expression $b^2 - 4ac$ is known as the **discriminant** and is often represented by the delta symbol $\Delta = b^2 - 4ac$.

MATHEMATICS – Higher Level (Core)

In particular, there are three cases to address:

Case 1. $b^2 - 4ac > 0$

Case 2. $b^2 - 4ac = 0$

Case 3. $b^2 - 4ac < 0$

Case 1. $b^2 - 4ac > 0$

In this case, the expression $x = \frac{-b \pm \sqrt{b^2 - 4ac}}{2a}$ produces **two real solutions**.

This is because taking the square root of a positive number will produce another positive real number. This in turn implies that there will be one solution corresponding to the '+' term and one solution corresponding to the '-' term.

That is, say that $\sqrt{b^2 - 4ac} = K$, where K is a real number. We then have that

$$x = \frac{-b \pm K}{2a}, \text{ i.e., } x_1 = \frac{-b + K}{2a}, x_2 = \frac{-b - K}{2a}, \text{ giving } \mathbf{two\ distinct\ real\ solutions}.$$

Case 2. $b^2 - 4ac = 0$

In this case, the expression $x = \frac{-b \pm \sqrt{b^2 - 4ac}}{2a}$ produces only **one real solution**.

This is because taking the square root of zero gives zero. This in turn implies that there will be only one solution because adding and subtracting '0' to the '-b' term in the numerator will not alter the answer.

That is, if $\sqrt{b^2 - 4ac} = 0$, we then have that $x = \frac{-b \pm 0}{2a} = -\frac{b}{2a}$ meaning that we have only **one real solution** (or two repeated solutions).

Case 3. $b^2 - 4ac < 0$

In this case, the expression $x = \frac{-b \pm \sqrt{b^2 - 4ac}}{2a}$ produces **no real solution**.

This is because the square root of a negative number will not produce a **real** number. This in turn implies that the formula cannot be utilised (if we are dealing with quadratic equations under the real numbers).

Summary

Discriminant $\Delta = b^2 - 4ac$	Number of solutions for $ax^2 + bx + c = 0$
$\Delta > 0$	Can be factorised to obtain 2 real and unique solutions.
$\Delta = 0$	Can be factorised to obtain 1 real (repeated) solution.
$\Delta < 0$	Cannot be factorised and so no real solutions exist.

EXAMPLE 2.26

- (a) Find the value(s) of m for which the equation $2x^2 + mx + 1 = 0$ has one real solution.
 (b) Find the value(s) of k for which the equation $x^2 + 4x + k = 0$ has two real solutions.

Solution

- (a) For one real solution to exist, we must have that $\Delta = b^2 - 4ac = 0$.
 For this quadratic we have that $a = 2$, $b = m$ and $c = 1$.

Therefore, we need that $m^2 - 4 \times 2 \times 1 = 0$

$$\Leftrightarrow m^2 - 8 = 0$$

$$\Leftrightarrow (m - \sqrt{8})(m + \sqrt{8}) = 0$$

$$\therefore m = 2\sqrt{2} \text{ or } m = -2\sqrt{2}$$

- (b) For two real solutions, we must have that $\Delta = b^2 - 4ac > 0$.
 For this quadratic we have that $a = 1$, $b = 4$ and $c = k$.

Therefore, we need that $4^2 - 4 \times 1 \times k > 0$

$$\Leftrightarrow 16 - 4k > 0$$

$$\Leftrightarrow 16 > 4k$$

$$\Leftrightarrow 4 > k.$$

i.e., the quadratic $x^2 + 4x + k = 0$ will have two real solutions as long as $k < 4$.

EXAMPLE 2.27

Find k if the equation $x^2 - (k + 3)x + (k + 6) = 0$ has

- (a) 1 root (b) 2 real roots (c) no real root.

Solution

First we find an expression for the discriminant in terms of k :

Using the values $a = 1$, $b = k + 3$ and $c = k + 6$, we have:

$$\Delta = b^2 - 4ac = (k + 3)^2 - 4 \times 1 \times (k + 6)$$

$$= k^2 + 2k - 15$$

$$= (k + 5)(k - 3)$$

- (a) For the equation to have 1 solution, the discriminant, $\Delta = 0$, thus,

$$(k + 5)(k - 3) = 0 \Leftrightarrow k = -5, \text{ or } k = 3$$

That is, the solution set is $\{k : k = -5, 3\}$.

- (b) For the equation to have 2 solutions, the discriminant, $\Delta > 0$, thus,

$$(k + 5)(k - 3) > 0 \Leftrightarrow k < -5 \text{ or } k > 3 \quad \text{Using a sign diagram for } k:$$

That is, the solution set is $\{k : k < -5\} \cup \{k : k > 3\}$.



- (c) For the equation to have no real solutions, the discriminant, $\Delta < 0$, thus,

$$(k + 5)(k - 3) < 0 \Leftrightarrow -5 < k < 3 \quad \text{Using a sign diagram for } k:$$

That is, the solution set is $\{k : -5 < k < 3\}$.



EXERCISES 2.4.1

1. By using a factorisation process, solve for the given variable.

- (a) $x^2 + 10x + 25 = 0$ (b) $x^2 - 10x + 24 = 0$
 (c) $3x^2 + 9x = 0$ (d) $x^2 - 4x + 3 = 0$
 (e) $(3 - u)(u + 6) = 0$ (f) $3x^2 + x - 10 = 0$
 (g) $3v^2 - 12v + 12 = 0$ (h) $y(y - 3) = 18$
 (i) $(x + 3)(x + 2) = 12$ (j) $(2a - 1)(a - 1) = 1$

2. Without using the quadratic formula, solve for the given variable.

- (a) $u + \frac{1}{u} = -2$ (b) $x + 2 = \frac{35}{x}$ (c) $5x - 13 = \frac{6}{x}$
 (d) $\frac{x}{2} - \frac{1}{x+1} = 0$ (e) $y + 1 = \frac{4}{y+1}$ (f) $v + \frac{20}{v} = 9$

3. By completing the square, solve for the given variable.

- (a) $x^2 + 2x = 5$ (b) $x^2 + 4 = 6x$ (c) $x^2 - 2x = 4$
 (d) $4x^2 + x = 2$ (e) $2y^2 = 9y - 1$ (f) $3a^2 - a = 7$

4. Use the quadratic formula to solve these equations.

- (a) $x^2 - 3x - 7 = 0$ (b) $x^2 - 5x = 2$
 (c) $x^2 - 3x - 6 = 0$ (d) $x^2 = 7x + 2$
 (e) $x(x + 7) = 4$ (f) $x^2 + 2x - 8 = 0$
 (g) $x^2 + 2x - 7 = 0$ (h) $x^2 + 5x - 7 = 0$
 (i) $x^2 - 3x - 7 = 0$ (j) $x^2 - 3x + 9 = 0$
 (k) $x^2 + 9 = 8x$ (l) $4x^2 - 8x + 9 = 0$
 (m) $4x^2 = 8x + 9$ (n) $5x^2 - 6x - 7 = 0$
 (o) $5x^2 - 12x + 1 = 0$ (p) $7x^2 - 12x + 1 = 0$

5. For what value(s) of p does the equation $x^2 + px + 1 = 0$ have

- (a) no real solutions
 (b) one real solution
 (c) two real solutions.

6. Find the values of m for which the quadratic $x^2 + 2x + m = 0$ has

- (a) one real solution
 (b) two real solutions
 (c) no real solutions.

7. Find the values of m for which the quadratic $x^2 + mx + 2 = 0$ has

- (a) one real solution
 (b) two real solutions
 (c) no real solutions.

- 8.** Find the values of k for which the quadratic $2x^2 + kx + 9 = 0$ has
 - (a) one real solution
 - (b) two real solutions
 - (c) no real solutions.

- 9.** Consider the equation $x^2 + 2x = 7$. Prove that this equation has two real roots.

- 10.** Find the value(s) of p such that the equation $px^2 - px + 1 = 0$ has exactly one real root.

- 11.** Prove that the equation $kx^2 + 3x = k$ has two real solutions for all non-zero real values of k .

2.4.2 QUADRATIC FUNCTION

A **quadratic function** has the general form $f(x) = ax^2 + bx + c$, $a \neq 0$ and $a, b, c \in \mathbb{R}$. All quadratic functions have **parabolic graphs** and have a **vertical axis of symmetry**.

If $a > 0$, the parabola is concave up:

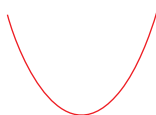

If $a < 0$ the parabola is concave down:



General Properties of the graph of

$$f(x) = ax^2 + bx + c, a \neq 0$$

1. y-intercept

This occurs when $x = 0$, so that $y = f(0) = a(0)^2 + b(0) + c = c$.

That is, the curve passes through the point $(0, c)$

2. x-intercept(s)

This occurs where $f(x) = 0$.

Therefore we need to solve $ax^2 + bx + c = 0$.

To solve we either factorise and solve or use the quadratic formula, which would provide

the solution(s) $x = \frac{-b \pm \sqrt{b^2 - 4ac}}{2a}$.

3. Axis of symmetry

This occurs at $x = -\frac{b}{2a}$.

4. Vertex (turning point)

The vertex occurs when $x = -\frac{b}{2a}$. Then, to find the y -value, find $f\left(-\frac{b}{2a}\right)$

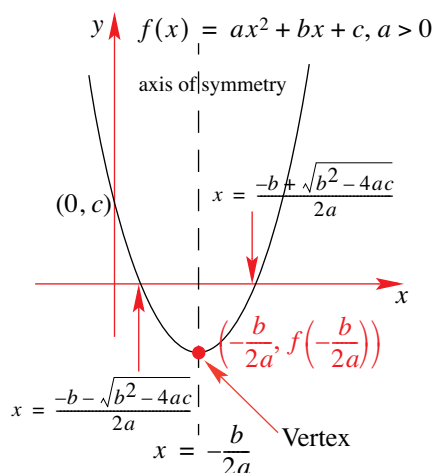

Geometrical Interpretation and The Discriminant

Just as it was the case for linear functions, solving the quadratic $ax^2 + bx + c = k$ is geometrically equivalent to finding where the parabola with function $f(x) = ax^2 + bx + c$ meets the graph (horizontal straight line) $y = k$. Then, when $k = 0$, we are finding where the parabola meets the line $y = 0$, i.e., we are finding the x -intercept(s). Based on our results of the discriminant about the number of solutions to the equation $ax^2 + bx + c = 0$, we can extend these results to the following:

The number of x -intercepts for the function $f(x) = ax^2 + bx + c$ = The number of solutions to the equation $ax^2 + bx + c = 0$

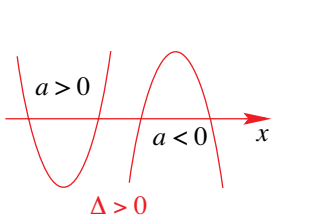
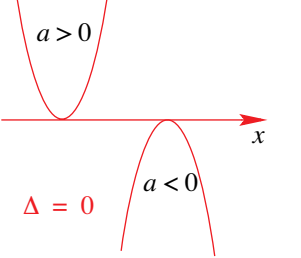
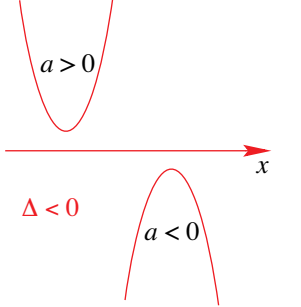
If $\Delta = b^2 - 4ac > 0$, then there are two x-intercepts .	If $\Delta = b^2 - 4ac = 0$, then there is one x-intercept .	If $\Delta = b^2 - 4ac < 0$, then there are no x-intercepts .
		

Sketching the graph of a quadratic function

Two methods for sketching the graph of $f(x) = ax^2 + bx + c, a \neq 0$ are:

Method 1: The intercept method

i.e., expressing $f(x) = ax^2 + bx + c, a \neq 0$ in the form $f(x) = a(x - p)(x - q)$

This involves

Step 1 Finding the x -intercepts [by solving $ax^2 + bx + c = 0$]

Step 2 Finding the y -intercept [finding $f(0)$]

Step 3 Sketch parabola passing through the three points

Method 2: The turning-point form

i.e., expressing $f(x) = ax^2 + bx + c, a \neq 0$ in the form $f(x) = a(x - h)^2 + k$

This involves

Step 1 Expressing $f(x) = ax^2 + bx + c, a \neq 0$ in the form $a(x - h)^2 + k$ [by completing the square]

Step 2 Use the turning point (h, k)

Step 3 Finding the y -intercept [finding $f(0)$]

Step 4 Sketch the parabola passing through the two points

EXAMPLE 2.27

Sketch the graph of

- (a) $f(x) = x^2 - 6x + 8$ (b) $f(x) = 3x^2 + 12x + 4$ using
 i. the intercept method ii. the turning point method

**S
o
l
u
t
i
o
n**

- (a) i. For the intercept method we start by factorising the quadratic:

$$f(x) = x^2 - 6x + 8 = (x - 4)(x - 2).$$

Then, for the x -intercepts we have:

$$f(x) = 0 \Leftrightarrow (x - 4)(x - 2) = 0 \Leftrightarrow x = 2 \text{ or } x = 4$$

Next, the y -intercept:

$$x = 0 \Rightarrow f(0) = 0^2 - 6(0) + 8 = 8.$$

Summary: Parabola passes through (2, 0), (4, 0) and (0, 8).

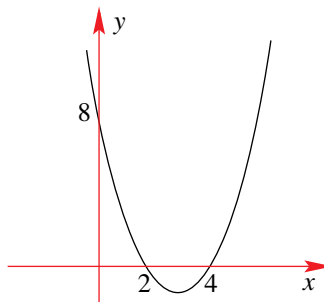

Note, the axis of symmetry is the midpoint of the x -intercepts,

$$\text{i.e., } x = \frac{2+4}{2} = \frac{6}{2} = 3. \text{ Or use } x = -\frac{b}{2a} = -\frac{-6}{2} = 3$$

- ii. We first complete the square:

$$f(x) = x^2 - 6x + 8 = (x^2 - 6x + 9) - 1 = (x - 3)^2 - 1$$

Therefore, the parabola has a turning point at (3, -1)

Then find the y -intercept:

$$x = 0 \Rightarrow f(0) = 0^2 - 6(0) + 8 = 8$$

Summary: Parabola passes through (3, -1) and (0, 8).

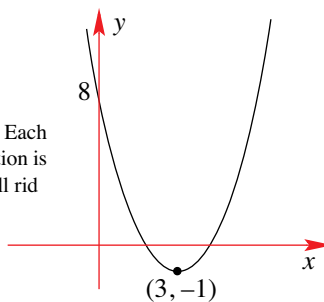

Notice that both graphs are the same but display different information. Each display has its strengths and weaknesses – it depends on what information is important for the question. Of course, including all the information will rid us of any problems.

- (b) i. For the intercept method we start by factorising the quadratic:

$$\begin{aligned} f(x) &= 3x^2 + 12x + 4 = 3(x^2 + 4x + 4) - 12 + 4 \text{ [completing the square]} \\ &= 3(x + 2)^2 - 8 \text{ [next use difference of two squares]} \\ &= [\sqrt{3}(x + 2) - 2\sqrt{2}][\sqrt{3}(x + 2) + 2\sqrt{2}]. \end{aligned}$$

Then, for the x -intercepts we have:

$$f(x) = 0 \Rightarrow [\sqrt{3}(x + 2) - 2\sqrt{2}][\sqrt{3}(x + 2) + 2\sqrt{2}] = 0$$

$$\therefore x = -2 + 2\sqrt{\frac{2}{3}} \text{ or } x = -2 - 2\sqrt{\frac{2}{3}}$$

Note: It would have been quicker to find the intercepts if we had used the quadratic formula!

MATHEMATICS – Higher Level (Core)

Next, the y -intercept:

$$x = 0 \Rightarrow f(0) = 3(0)^2 + 12(0) = 4 = 4.$$

Summary: Parabola passes through $(-2 - 2\sqrt{\frac{2}{3}}, 0)$, $(-2 + 2\sqrt{\frac{2}{3}}, 0)$ and $(0, 4)$.

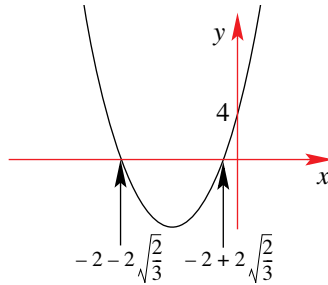

ii. We first complete the square:

$$\begin{aligned} f(x) &= 3x^2 + 12x + 4 = 3(x^2 + 4x + 4) - 12 + 4 \text{ [completing the square]} \\ &= 3(x + 2)^2 - 8 \end{aligned}$$

Therefore, the parabola has a turning point at $(-2, -8)$

Then find the y -intercept:

$$x = 0 \Rightarrow f(0) = 3(0)^2 + 12(0) = 4 = 4.$$

Summary: Parabola passes through $(-2, -8)$ and $(0, 4)$.

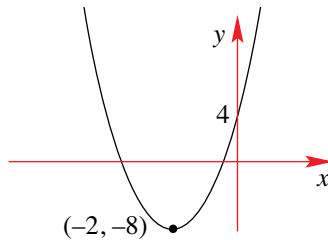

EXAMPLE 2.28

For what value(s) of k will the function $f(x) = x^2 + 6x + k$

- (a) cut the x -axis twice (b) touch the x -axis (c) have no x -intercepts

S
O
L
V
E
D
I
N

We will need to use the relationship between the number of x -intercepts of the function $f(x) = x^2 + 6x + k$ and the number of solutions to the equation $x^2 + 6x + k = 0$. To do this we first find the discriminant: $\Delta = b^2 - 4ac = (6)^2 - 4 \times 1 \times k = 36 - 4k$.

- (a) If the function cuts twice, then $\Delta > 0 \Rightarrow 36 - 4k > 0 \Leftrightarrow k < 9$.
- (b) If the function touches the x -axis, then we have repeated solutions (or roots), in this case we have only one solution, so $\Delta = 0 \Rightarrow 36 - 4k = 0 \Leftrightarrow k = 9$.
- (c) If the function has no x -intercepts, then $\Delta < 0 \Rightarrow 36 - 4k < 0 \Leftrightarrow k > 9$.

So far we have sketched a graph from a given function, but what about finding the equation of a given graph?

Finding the equation from a graph

If sufficient information is provided on a graph, then it is possible to obtain the equation that corresponds to that graph. When dealing with quadratics there are some standard approaches that can be used (depending on the information provided).

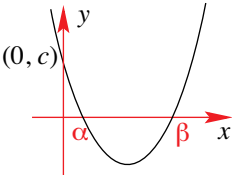
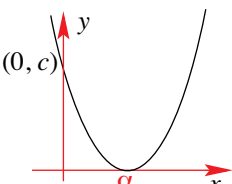
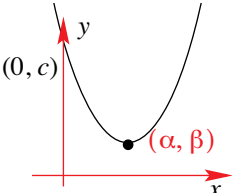
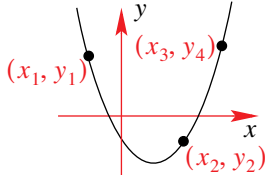
Information provided	Process
<p>Graph cuts the x-axis at two points:</p> 	<p>Use the function $f(x) = k(x - \alpha)(x - \beta)$ and then use the point $(0, c)$ to solve for k.</p>
<p>Graph touches the x-axis at $x = \alpha$:</p> 	<p>Use the function $f(x) = k(x - \alpha)^2$ and then use the point $(0, c)$ to solve for k.</p>
<p>Graph does not meet the x-axis:</p> 	<p>Use the function $f(x) = k(x - \alpha)^2 + \beta$ and then use the point $(0, c)$ to solve for k.</p>
<p>Three arbitrary points are given:</p> 	<p>Use the function $f(x) = ax^2 + bx + c$ and then set up and solve the system of simultaneous equations by substituting each coordinate into the function:</p> $ax_1^2 + bx_1 + c = y_1$ $ax_2^2 + bx_2 + c = y_2$ $ax_3^2 + bx_3 + c = y_3$

Note: the process is identical for a downward concave parabola.

EXAMPLE 2.29

Find the equation defining each of the following graphs.

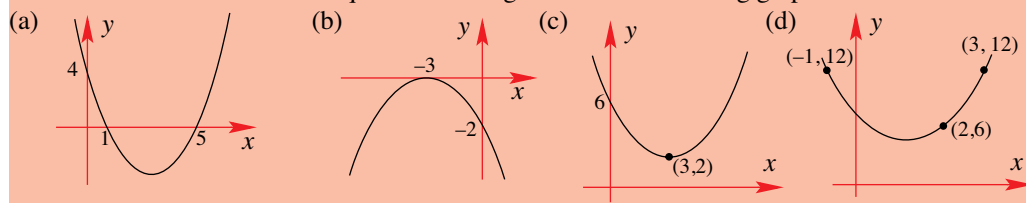

(a) Using the form $f(x) = k(x - \alpha)(x - \beta)$ we have $f(x) = k(x - 1)(x - 5)$.

Next, when $x = 0, y = 4$, therefore, $4 = k(0 - 1)(0 - 5) \Leftrightarrow 4 = 5k \Leftrightarrow k = \frac{4}{5}$.

Therefore, $f(x) = \frac{4}{5}(x - 1)(x - 5)$.

(b) Graph touches x -axis at $x = -3$, therefore use $f(x) = k(x + 3)^2$.

As graph passes through $(0, -2)$, we have $-2 = k(0 + 3)^2 \Leftrightarrow -2 = 9k \Leftrightarrow k = -\frac{2}{9}$.

Therefore, $f(x) = -\frac{2}{9}(x + 3)^2$.

(c) Graph shows turning point and another point, so use the form $f(x) = k(x - \alpha)^2 + \beta$.

So we have, $f(x) = k(x - 3)^2 + 2$.

Then, as graph passes through $(0, 6)$, we have $6 = k(0 - 3)^2 + 2 \Leftrightarrow 4 = 9k \Leftrightarrow k = \frac{4}{9}$.

Therefore, $f(x) = \frac{4}{9}(x - 3)^2 + 2$.

(d) As we are given three arbitrary points, we use the general equation $f(x) = ax^2 + bx + c$.

From $(-1, 12)$ we have $12 = a(-1)^2 + b(-1) + c$ i.e., $12 = a - b + c$ — (1)

From $(2, 6)$ we have $6 = a(2)^2 + b(2) + c$ i.e., $6 = 4a + 2b + c$ — (2)

From $(3, 12)$ we have $12 = a(3)^2 + b(3) + c$ i.e., $12 = 9a + 3b + c$ — (3)

Solving for a, b and c we have: (2) - (1): $-6 = 3a + 3b$

i.e., $-2 = a + b$ — (3)

(3) - (2): $6 = 5a + b$ — (4)

(4) - (3): $8 = 4a \Leftrightarrow a = 2$

Substitute $a = 2$ into (3): $-2 = 2 + b \Leftrightarrow b = -4$.

Substitute results into (1): $12 = 2 - (-4) + c \Leftrightarrow c = 6$.

Therefore function is $f(x) = 2x^2 - 4x + 6$

EXERCISES 2.4.2

1. Express the following functions in turning point form and hence sketch their graphs.

- | | | |
|------------------------------------|----------------------------------|-------------------------|
| (a) $y = x^2 - 2x + 1$ | (b) $y = x^2 + 4x + 2$ | (c) $y = x^2 - 4x + 2$ |
| (d) $y = x^2 + x - 1$ | (e) $y = x^2 - x - 2$ | (f) $y = x^2 + 3x + 1$ |
| (g) $y = -x^2 + 2x + 1$ | (h) $y = -x^2 - 2x + 2$ | (i) $y = 2x^2 - 2x - 1$ |
| (j) $y = -\frac{1}{2}x^2 + 3x - 2$ | (k) $y = -\frac{x^2}{3} + x - 2$ | (l) $y = 3x^2 - 2x + 1$ |

2. Find the axial intercepts of these quadratic functions (correct to 2 decimal places) and hence sketch their graphs.

- | | | | |
|----------------------------------|----------------------------------|-------------------------|--|
| (a) $y = x^2 + 3x + 2$ | (b) $y = x^2 - x - 6$ | (c) $y = 2x^2 - 5x - 3$ | |
| (d) $y = x^2 - 4$ | (e) $y = x^2 + x - 5$ | (f) $y = -x^2 + x + 6$ | |
| (g) $y = -x^2 + x + 1$ | (h) $y = -2x^2 - 3x + 5$ | (i) $y = 2x^2 + 5x - 3$ | |
| (j) $y = \frac{x^2}{3} - 2x + 3$ | (k) $y = -\frac{x^2}{2} + x + 4$ | (l) $y = 3x^2 - 2x - 4$ | |

3. For the quadratic function $f(x) = 2x^2 - 4x + 1$, find

- (a) the equation of the axis of symmetry.
 (b) the coordinates of the vertex.
 (c) the i. x -intercept(s) i. y -intercept.
 Hence, sketch the graph of the function.

4. For the quadratic function $f(x) = 7 + 4x - 2x^2$, find

- (a) the equation of the axis of symmetry.
 (b) the coordinates of the vertex.
 (c) the i. x -intercept(s) ii. y -intercept.
 Hence, sketch the graph of the function.

5. For what value(s) of k will the graph of $y = x^2 - 3x + k$

- (a) touch the x -axis (b) cut the x -axis (c) never meet the x -axis?

6. For what value(s) of k will the graph of $y = kx^2 + 5x + 2$

- (a) touch the x -axis (b) cut the x -axis (c) never meet the x -axis?

7. For what value(s) of k will the graph of $y = kx^2 - 2x + k$

- (a) touch the x -axis (b) cut the x -axis (c) never meet the x -axis?

8. Find the equation of the quadratic function with graph

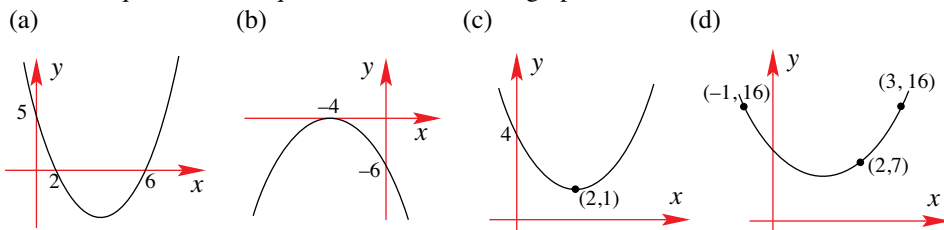

9. Find the equation of the quadratic function with graph

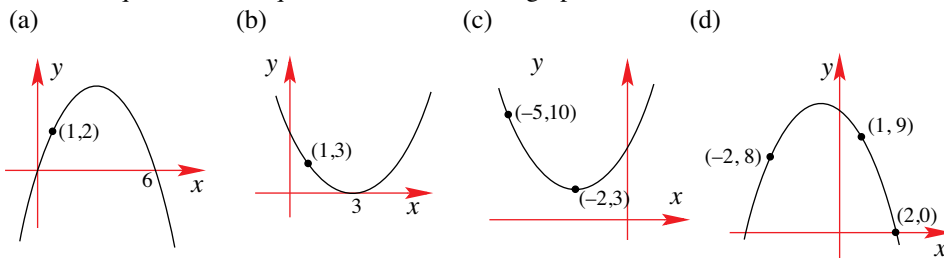

2.4.3 QUADRATIC INEQUALITIES

Quadratic inequations arise from replacing the ‘=’ sign in a quadratic by an inequality sign. Solving inequations can be carried out in two ways, either algebraically or graphically.

Method 1 Algebraic Method

This method relies on factorising the quadratic and then using the fact that when two terms, a and b are multiplied, the following rules apply:

$$1. \quad ab > 0 \Leftrightarrow a > 0 \text{ and } b > 0 \text{ or } a < 0 \text{ and } b < 0$$

$$2. \quad ab < 0 \Leftrightarrow a > 0 \text{ and } b < 0 \text{ or } a < 0 \text{ and } b > 0$$

The same rules apply if we replace ‘>’ with ‘≥’ and ‘<’ with ‘≤’

EXAMPLE 2.30

Find

$$(a) \quad \{x \mid x^2 - 6x + 8 > 0\} \quad (b) \quad \{x \mid 2x^2 + 5x - 3 \leq 0\} \quad (c) \quad \{x \mid x^2 - 3 < 2x\}$$

S
o
l
u
t
i
o
n

(a) We start by factorising the quadratic: $x^2 - 6x + 8 = (x - 2)(x - 4)$

Then, $x^2 - 6x + 8 > 0 \Leftrightarrow (x - 2)(x - 4) > 0$

Which means either $x - 2 > 0$ **and** $x - 4 > 0$ i.e., $x > 2$ **and** $x > 4 \Rightarrow x > 4$ – (1)

or $x - 2 < 0$ **and** $x - 4 < 0$ i.e., $x < 2$ **and** $x < 4 \Rightarrow x < 2$ – (2)

Then, combining (1) and (2) we have $\{x \mid x^2 - 6x + 8 > 0\} = \{x \mid x < 2\} \cup \{x \mid x > 4\}$.

(b) Now, $2x^2 + 5x - 3 \leq 0 \Leftrightarrow (2x - 1)(x + 3) \leq 0$.

Meaning that either $2x - 1 \leq 0$ **and** $x + 3 \geq 0$ i.e., $x \leq \frac{1}{2}$ **and** $x \geq -3$ – (1)

or $2x - 1 \geq 0$ **and** $x + 3 \leq 0$ i.e., $x \geq \frac{1}{2}$ **and** $x \leq -3$ – (2)

From result (1) we have that $-3 \leq x \leq \frac{1}{2}$.

However, the inequalities in result (2) are inconsistent, i.e., we cannot have that x is both greater than or equal to $\frac{1}{2}$ **and** less than or equal to -3 **simultaneously**. Therefore we

discard this inequality. Therefore, $\{x \mid 2x^2 + 5x - 3 \leq 0\} = \left\{x \mid -3 \leq x \leq \frac{1}{2}\right\}$

(c) This time we need some rearranging:

$$x^2 - 3 < 2x \Leftrightarrow x^2 - 2x - 3 < 0 \Leftrightarrow (x + 1)(x - 3) < 0$$

Then, we must have that $x + 1 < 0$ **and** $x + 3 > 0$ i.e., $x < -1$ **and** $x > -3$ – (1)

$x + 1 > 0$ **and** $x + 3 < 0$ i.e., $x > -1$ **and** $x < -3$ – (2)

This time (1) is inconsistent, so we discard it and from (2) we have $-1 < x < 3$.

Therefore, $\{x \mid x^2 - 3 < 2x\} = \{x \mid -1 < x < 3\}$.

Method 2 Graphical Method

This method relies on examining the graph of the corresponding quadratic function and then

1. quoting the x -values that produce y -values that lie above (or on) the x -axis (i.e., $y > 0$ or $y \geq 0$)
- or 2. quoting x -values that produce y -values that lie below (or on) the x -axis (i.e., $y < 0$ or $y \leq 0$)

We consider inequations from Example 2.30

EXAMPLE 2.31

Use a graphical method to find

- (a) $\{x \mid x^2 - 6x + 8 > 0\}$ (b) $\{x \mid 2x^2 + 5x - 3 \leq 0\}$ (c) $\{x \mid x^2 - 3 < 2x\}$

Solution

- (a) The corresponding function in this case is $f(x) = x^2 - 6x + 8$.

That part of the graph corresponding to $f(x) > 0$ is highlighted in red. The values of x that correspond to these parts are

$$x < 2 \text{ as well as } x > 4$$

Therefore, s.s. = $\{x \mid x < 2\} \cup \{x \mid x > 4\}$

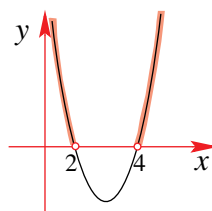

- (b) The corresponding function in this case is $f(x) = 2x^2 + 5x - 3$.

That part of the graph corresponding to $f(x) \leq 0$ is highlighted in red. The values of x that correspond to these parts are

$$-3 \leq x \leq \frac{1}{2}$$

Therefore, s.s. = $\left\{x \mid -3 \leq x \leq \frac{1}{2}\right\}$

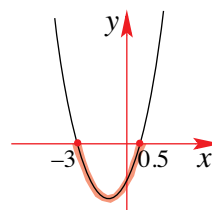

- (c) This time we have two functions, that of $f(x) = x^2 - 3$ and

$g(x) = 2x$, and we want to find those values of x where

$$f(x) < g(x).$$

We do this by sketching both graphs on the same set of axes and then finding those values of x for which $f(x) < g(x)$ i.e., where

the graph of $y = g(x)$ lies above that of $y = f(x)$.

Once we have found the point of intersection, i.e., once we have

solved $f(x) = g(x)$, we refer to the graph.

$$\text{Now, } f(x) = g(x) \Leftrightarrow x^2 - 3 = 2x \Leftrightarrow x^2 - 2x - 3 = 0$$

$$\Leftrightarrow (x - 3)(x + 1) = 0$$

$$\Leftrightarrow x = 3 \text{ or } x = -1$$

Then, $f(x) < g(x)$ for $-1 < x < 3$.

$$\text{i.e., } \{x \mid x^2 - 3 < 2x\} = \{x \mid -1 < x < 3\}.$$

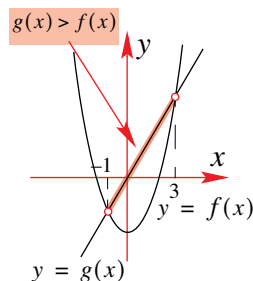

Part (c) in Example 2.31 leads us to a process that deals with any expression of the form $f(x) < g(x)$, $f(x) > g(x)$, $f(x) \leq g(x)$ or $f(x) \geq g(x)$. Basically, we have the following:

To solve an inequality between two functions, $f(x)$ and $g(x)$, i.e., to solve for $f(x) < g(x)$, $f(x) > g(x)$, $f(x) \leq g(x)$ or $f(x) \geq g(x)$

We proceed as follows:

1. Sketch the corresponding graphs of both $f(x)$ and $g(x)$ on the same set of axes.
2. Find where the two graphs intersect, i.e., solve $f(x) = g(x)$ so that we find $x = a$ and $x = b$.
3. Identify where one function lies above or below the other. Then, depending on the inequality, quote the values of x that correspond to that region (or those regions).

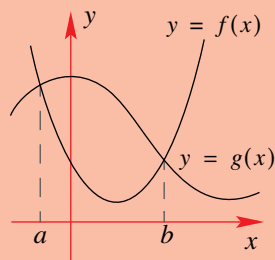

e.g., $f(x) > g(x) \Leftrightarrow x \in]-\infty, a[\cup]b, \infty[$ and $f(x) \leq g(x) \Leftrightarrow x \in [a, b]$

EXAMPLE 2.32

Use a graphical method to find $\{x \mid |x| < 2 - x^2 + 2x\}$

Solution

We make use of the TI-83 to solve this problem.

Let $g(x) = |x|$ and $f(x) = 2 - x^2 + 2x$, we sketch these graphs on the same set of axes.

Next we need to find where the two graphs intersect. That is we need to solve the equation $g(x) = f(x)$. So, we have:

$$|x| = 2 - x^2 + 2x$$

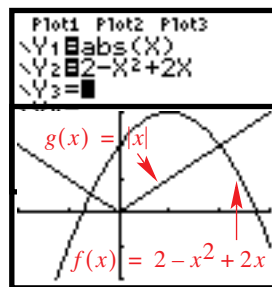

Using the **intersect** option from the **CALC** menu we have:

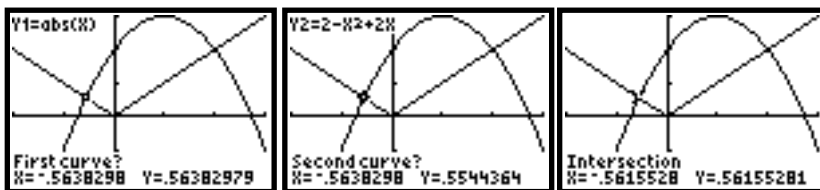

Having found one point of intersection, we now find the other:

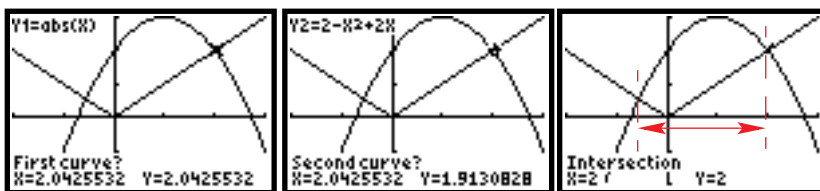

Therefore, from our results we have that $\{x \mid |x| < 2 - x^2 + 2x\} = \{x \mid -0.5616 < x < 2\}$.

Notice once again, the the graphics calculator could only provide an approximate answer for one of the points of intersection.

EXERCISES 2.4.3

- 1.** Find the solution set for each of the following inequalities.
- (a) $(x-1)(x+2) > 0$ (b) $(x+3)(x-2) \leq 0$
 (c) $x(4-x) \leq 0$ (d) $(1-3x)(x-3) > 0$
 (e) $(3+2x)(x+1) \geq 0$ (f) $(5-2x)(3-4x) < 0$
- 2.** Find the solution set for each of the following inequalities.
- (a) $x^2 + 3x + 2 > 0$ (b) $x^2 - x - 6 < 0$ (c) $2x^2 - 5x - 3 \geq 0$
 (d) $x^2 - 4 \leq 0$ (e) $x^2 + x - 5 < 0$ (f) $-x^2 + x + 6 \leq 0$
 (g) $-x^2 + x + 1 \geq 0$ (h) $-2x^2 - 3x + 5 \geq 0$ (i) $2x^2 + 5x - 3 > 0$
 (j) $x^2 - 4x + 3 < 0$ (k) $2x^2 + x - 1 < 0$ (l) $x^2 + 3 < 0$
 (m) $-x^2 - 2 > 0$ (n) $2x^2 - 7x \leq 15$ (o) $3x^2 + 5x > 2$
- 3.** (a) For what value(s) of k is the inequation $x^2 + 2kx - k > 0$ true for all values of x ?
 (b) For what value(s) of k is the inequation $x^2 - kx + 2 \geq 0$ true for all values of x ?
 (c) For what value(s) of n is the inequation $x^2 + 2x \geq 2n$ true for all values of x ?
- 4.** By sketching on the same set of axes, the graphs of the functions $f(x)$ and $g(x)$, solve the inequalities
- i. $f(x) < g(x)$ ii. $f(x) \geq g(x)$
- (a) $f(x) = x + 2$, $g(x) = x^2$ (b) $f(x) = x - 1$, $g(x) = x^2 - 4x + 5$
 (c) $f(x) = x^2 + 2$, $g(x) = 4x - 1$ (d) $f(x) = 3x^2 - 1$, $g(x) = x + 1$
 (e) $f(x) = 5 - x^2$, $g(x) = x^2 - 3$ (f) $f(x) = x^2 - 3x - 3$, $g(x) = x - 4$
- 5.** On the same set of axes sketch the graphs of $f(x) = |x - 1|$ and $g(x) = 1 - x^2$. Hence find $\{x : |x - 1| < 1 - x^2\}$.
- 6.** Given that $f(x) = x^2 + 3x + 2$ and $g(x) = 4 - x^2$, find $\{x : f(x) \leq g(x)\}$.
- 7.** (a) Find $\{x : |x^2 - 4x| < k\}$ for i. $k = 2$ ii. $k = 4$ iii. $k = 8$
 (b) Find i. $\{x : |2x - 3| \leq 3x - x^2\}$ ii. $\left\{x : |3 - |x|| \leq \left|3 - \frac{1}{3}x^2\right|\right\}$
- 8.** Find (a) $\left\{x : \frac{x-2}{x+3} > 0\right\}$ (b) $\left\{x : \frac{4-x}{x+1} > 0\right\}$
 (c) $\left\{x : \frac{1-2x}{x^2+1} > k\right\}$ where i. $k = 0$ ii. $k = 1$
- 9.** (a) Find $\{x : 2|x| + 1 < 3 - 2(x-k)^2\}$ for i. $k = \pm 1$ ii. $k = 2$
 (b) Find $\{k : 2|x| + 1 < 3 - 2(x-k)^2, k > 0\} = \emptyset$.

2.4.4 SIMULTANEOUS EQUATIONS INVOLVING LINEAR – QUADRATIC EQUATIONS

In part (c) of Examples 2.30 and 2.31 we have already found the need to solve simultaneous equations where one equation was a quadratic, i.e., $f(x) = x^2 - 3$ and the other was linear, i.e., $g(x) = 2x$. In this instance, we equated the two functions, $f(x) = g(x)$ so that $x^2 - 3 = 2x$, then transposed to get a new quadratic, i.e., $x^2 - 2x - 3 = 0$ which could readily be solved for x . In this section we formalise the process of solving simultaneous equations involving a quadratic and linear expression or two quadratic expressions.

To solve a **linear–quadratic** system of equations it is often the case that the method of substitution is most appropriate. The process is as follows:

Step 1: Arrange the equations so that they are both in the form $y = \dots$
i.e., y is expressed **explicitly** in terms of x .

Step 2: Label the two equations $y = ax^2 + bx + c - (1)$
 $y = mx + k - (2)$

Step 3: Equate (1) and (2): $mx + k = ax^2 + bx + c$

Step 4: Transpose to obtain a new quadratic:
 $ax^2 + (b - m)x + (c - k) = 0$

Step 5: Solve for x and then find y by substituting into (1) or (2).

EXAMPLE 2.33

Solve the simultaneous system of equations

$$\begin{array}{ll} \text{(a)} & y = x^2 + 3x - 6 \\ & y = 2x - 4 \end{array} \qquad \begin{array}{ll} \text{(b)} & y = -2x^2 + 4x + 9 \\ & x + 2y = 7 \end{array}$$

S
o
i
l
u
t
i
o
n

(a) We label the equations as follows; $y = x^2 + 3x - 6 - (1)$
 $y = 2x - 4 - (2)$

Equating (1) to (2) gives: $2x - 4 = x^2 + 3x - 6$

Solving we have: $0 = x^2 + x - 2$
 $\Leftrightarrow = (x + 2)(x - 1)$
 $\Leftrightarrow x = -2, 1$

Substituting $x = -2$ into (2): $y = 2(-2) - 4 = -8$

$x = 1$ into (2): $y = 2(1) - 4 = -2$

The solution can be expressed as two coordinate pairs: $(-2, -8), (1, -2)$.

(b) The first step in this case is to make y the subject of the second equation and then to substitute this into the first equation.

i.e., $x + 2y = 7 \Leftrightarrow 2y = 7 - x \Leftrightarrow y = \frac{1}{2}(7 - x)$.

Therefore we have, $y = -2x^2 + 4x + 9$ – (1)

$$y = \frac{1}{2}(7 - x) \text{ – (2)}$$

Substituting [or equating] (2) into (1) gives: $\frac{7-x}{2} = -2x^2 + 4x + 9$

$$\Leftrightarrow 7 - x = -4x^2 + 8x + 18$$

$$\Leftrightarrow 4x^2 - 9x - 11 = 0$$

$$\therefore x = \frac{9 \pm \sqrt{(-9)^2 - 4 \times 4 \times (-11)}}{2 \times 4}$$

$$= \frac{9 \pm \sqrt{257}}{8}$$

$$\approx -0.88, 3.13$$

Substituting into (2): $y = \frac{1}{2}\left(7 - \frac{9 \pm \sqrt{257}}{8}\right) = \frac{47}{16} \pm \frac{\sqrt{257}}{16}$

$$\approx 3.94, 1.94$$

The approximate coordinate pairs for the solution to this problem are $(-0.88, 3.94)$, $(3.13, 1.94)$.

Again, we see that the discriminant can be used to determine the geometrical relationship between the parabola and the straight line.

When solving the simultaneous system of equations

$$y = px^2 + qx + r \text{ – (1)}$$

$$y = mx + k \text{ – (2)}$$

which results in solving the quadratic $ax^2 + bx + c = 0$ (after equating (1) to (2)) we have three possible outcomes:

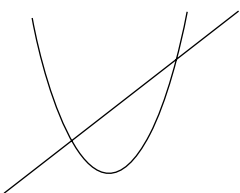
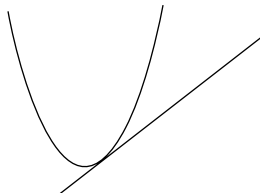
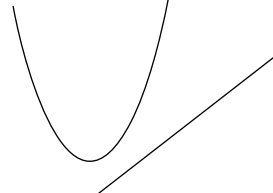
Case 1	Case 2	Case 3
 <p style="text-align: left; padding-left: 10px;">i.e., $\Delta = b^2 - 4ac > 0$ The straight line cuts the parabola twice.</p>	 <p style="text-align: left; padding-left: 10px;">i.e., $\Delta = b^2 - 4ac = 0$ The straight line touches the parabola at one point. We say the straight line is a tangent to the parabola.</p>	 <p style="text-align: left; padding-left: 10px;">i.e., $\Delta = b^2 - 4ac < 0$ The straight line neither touches nor cuts the parabola anywhere.</p>

EXAMPLE 2.34

Find the value(s) of m for which the straight line with equation $y = mx - 2$ is a tangent to the parabola with equation $y = x^2 - 3x + 7$.

S
o
l
u
t
i
o
n

We start by solving the system of equations as we have done previously:

$$y = x^2 - 3x + 7 \quad (1)$$

$$y = mx - 2 \quad (2)$$

Equating (1) to (2):

$$x^2 - 3x + 7 = mx - 2$$

$$\Leftrightarrow x^2 - (m + 3)x + 9 = 0$$

Then, for the straight line to be a tangent, it means that the line and the parabola touch. This in turn implies that the discriminant is zero.

$$\begin{aligned} \text{That is, } \Delta &= [-(m + 3)]^2 - 4 \times 1 \times 9 = (m + 3)^2 - 36 \\ &= (m + 3 + 6)(m + 3 - 6) \quad [\text{using the diff. of two squares}] \\ &= (m + 9)(m - 3) \end{aligned}$$

Then, setting $\Delta = 0$ we have $(m + 9)(m - 3) = 0 \Leftrightarrow m = -9$ or $m = 3$.

Geometrically we have:

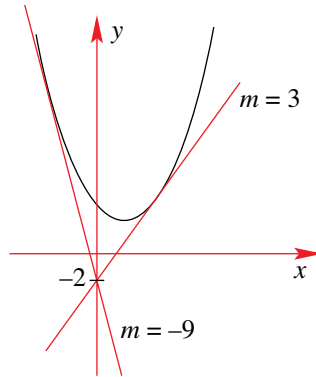

To solve a **quadratic–quadratic** system of equations we use the same method of substitution that was used for the linear–quadratic set up.

EXAMPLE 2.35

Solve simultaneously the system of equations $y = 2x^2 + 3x + 1$
 $y = 2x - x^2 + 3$

S
o
l
u
t
i
o
n

Set up the equations as follows:

$$y = 2x^2 + 3x + 1 \quad (1)$$

$$y = 2x - x^2 + 3 \quad (2)$$

Equating (1) to (2):

$$2x^2 + 3x + 1 = 2x - x^2 + 3$$

$$\Leftrightarrow 3x^2 + x - 2 = 0$$

$$\Leftrightarrow (3x - 2)(x + 1) = 0$$

$$\therefore x = \frac{2}{3} \text{ or } x = -1$$

Using (2): When $x = \frac{2}{3}$, $y = 2\left(\frac{2}{3}\right) - \left(\frac{4}{9}\right) + 3 = \frac{35}{9}$ and when $x = -1$, $y = -2 - 1 + 3 = 0$

Therefore, the pairs that satisfy this system of equations are $\left(\frac{2}{3}, \frac{35}{9}\right)$ and $(-1, 0)$.

EXERCISES 2.4.4

1. Solve the following pairs of simultaneous equations.

(a) $y = 2x + 1$
 $y = x^2 + 2x - 3$

(b) $y = x + 1$
 $y = x^2 + 2x - 1$

(c) $y = 3x - 1$
 $y = 3x^2 - 2x - 3$

(d) $3x - 2y = 3$
 $y = x^2 + 2x - 3$

(e) $x - 2y = 5$
 $y = x^2 + 4x - 7$

(f) $x + 2y = 0$
 $x^2 + 3y = 4$

(g) $y = 2x$
 $y = x^2 + x - 3$

(h) $x + 2y = 3$
 $y = -x^2 + 2x - 3$

(i) $y = 3x + 1$
 $y = x^2 + 2x - 3$

(j) $x - y = 1$
 $y = x^2 + x - 5$

(k) $3x - 2y = 3$
 $y = -x^2 + 2x - 3$

2. Solve the following simultaneous equations.

(a) $y = x^2 - 4x + 7$
 $y = 2x^2 + 2x$

(b) $y = 4x^2 - 16x + 8$
 $y = 9x - 8x^2 - 4$

(c) $y = 3x^2 - 2x + 2$
 $y = 2x^2 + x + 2$

(d) $y = 4x^2 + 3ax - 2a^2$
 $y = 2x^2 + 2ax - a^2$ where a is a real number

(e) $y = x^2 - 2x + 4$
 $y = 2 - 2x - x^2$

(f) $y = x^2 + 3x - 2$
 $y = 2x^2 - x + 2$

(g) $y = x^2 + 4x + 3$
 $y = 4x - x^2$

(h) $y = 5x^2 + x + 4$
 $y = x^2 + 5x + 3$

3. For what value(s) of m will the straight line with equation $y = mx - 6$

(a) touch (b) intersect (c) never meet
the parabola with equation $y = x^2$.

4. Find the distance between the points of intersection of the line with equation $y = 2x + 1$ and the parabola with equation $y = x^2 - 4x + 6$.

5. Find the value of a such that the line $y = 2x + a$ has exactly one intersection point with the parabola with equation $y = x^2 + 3x + 2$.

MATHEMATICS – Higher Level (Core)

- 6.** If the graph of the function $f(x) = 4x^2 - 20x - 4$ intersects the graph of the function $g(x) = 1 + 4x - x^2$ at the point (m, k) , show that the other point of intersection occurs where $x = -\frac{1}{m}$.
- 7.** For what value(s) of k is the line $2x = 3y + k$ a tangent to the parabola $y = x^2 - 3x + 4$?
- 8.** Show that the equations $\begin{cases} y = kx - 1 \\ y = x^2 + (k - 1)x + k^2 \end{cases}$ have no real solution for all values of k .
- 9.** For what values of k do $\begin{cases} y = kx \\ y = kx^2 + 3x + k \end{cases}$ have no solution?
- 10.** For what values of q do the equations $\begin{cases} y = (1 - q)x + 2 \\ y = -\frac{1}{qx} \end{cases}$ have only 1 real solution?
- 11.** Find the value for c , for some fixed value of m , so that the straight line $y = mx + c$ is a tangent to the parabola $y^2 = 4ax$, $a \neq 0$.
- 12.** The parabola with equation $y = ax^2 + x + ab$ meets the straight line with equation $y = a^2bx + 2ab$ where a and b are real constants at the points where $x = x_1$ and $x = x_2$. Show that $x_1x_2 + b = 0$.
- 13.** (a) Solve the simultaneous equations
 i. $\begin{cases} y = 3x^2 \\ y = 14 - 11x \end{cases}$ ii. $\begin{cases} y = 3x^2 \\ y = x + 14 \end{cases}$
- (b) The functions $f(x) = x + |2x|$ and $g(x) = -x^2 - \frac{2}{3}x + \frac{14}{3}$ intersect at the points $A(a, b)$ and $B(c, d)$ shown in the diagram below.
 i. Show that $3a^2 + 11a - 14 = 0$.
 ii. Show that $3c^2 - c - 14 = 0$.

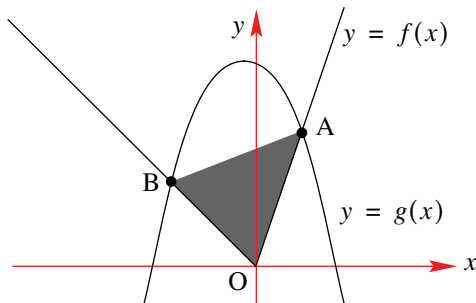

- (c) i. Find the equation of the straight line passing through the points A and B
 ii. Find the area of the region enclosed by the triangle OAB.

3.1 ALGEBRA OF POLYNOMIALS

3.1.1 DEFINITION

A polynomial function, $P(x)$, is an algebraic expression that takes the form

$$P(x) = a_n x^n + a_{n-1} x^{n-1} + a_{n-2} x^{n-2} + \dots + a_1 x^1 + a_0, \quad a_n \neq 0$$

where the coefficients $a_n, a_{n-1}, a_{n-2}, \dots, a_1, a_0$ are real numbers, and the power, $n, n-1, n-2, \dots$ are integers.

The **degree** of a polynomial, $\deg P(x)$, is the highest power of x in the expression.

Examples:

- $P(x) = -5x^4 + 2x^2 + x - 7$ is a polynomial of degree 4, i.e., $\deg P(x) = 4$, with a leading coefficient of -5 .
- $P(x) = 4x^3 + 6x^5 - x^2 + \sqrt{2}$ is a polynomial of degree 5, i.e., $\deg P(x) = 5$ with a leading coefficient of 6.

Polynomials can be rewritten in descending powers of x , $P(x) = 6x^5 + 4x^3 - x^2 + \sqrt{2}$.

- $P(x) = 3x^3 - x^2 + 2\sqrt{x} - 1$ is **not** a polynomial, because not all terms are raised to an integer power.

Some standard polynomials are:

Degree	Name	General form
0	constant	$P(x) = a$
1	linear	$P(x) = ax + b$
2	quadratic	$P(x) = ax^2 + bx + c$
3	cubic	$P(x) = ax^3 + bx^2 + cx + d$
4	quartic	$P(x) = ax^4 + bx^3 + cx^2 + dx + e$

3.1.2 ADDITION AND MULTIPLICATION OF POLYNOMIALS

The standard laws of algebra are readily applied to polynomials. We consider a number of examples to demonstrate the process of addition and multiplication of polynomials.

EXAMPLE 3.1

Consider the polynomials $P(x) = 2x^3 - x + 3$ and $T(x) = x^2 - 3$.

- Find
- $P(x) - 3T(x)$
 - $P(x) \times T(x)$
 - $[P(x)]^2$

$$\begin{aligned}
 \text{(a)} \quad P(x) - 3T(x) &= 2x^3 - x + 3 - 3(x^2 - 3) \\
 &= 2x^3 - x + 3 - 3x^2 + 9 \\
 &= 2x^3 - 3x^2 - x + 12 \\
 \text{(b)} \quad P(x) \times T(x) &= (2x^3 - x + 3)(x^2 - 3) \\
 &= x^2(2x^3 - x + 3) - 3(2x^3 - x + 3) \\
 &= 2x^5 - x^3 + 3x^2 - 6x^3 + 3x - 9 \\
 &= 2x^5 - 7x^3 + 3x^2 + 3x - 9 \\
 \text{(c)} \quad [P(x)]^2 &= (2x^3 - x + 3)^2 = (2x^3 - x + 3)(2x^3 - x + 3) \\
 &= 2x^3(2x^3 - x + 3) - x(2x^3 - x + 3) + 3(2x^3 - x + 3) \\
 &= 4x^6 - 2x^4 + 6x^3 - 2x^4 + x^2 - 3x + 6x^3 - 3x + 9 \\
 &= 4x^6 - 4x^4 + 12x^3 + x^2 - 6x + 9
 \end{aligned}$$

3.1.3 DIVISION OF POLYNOMIALS

We start by recalling how we can set out a division that involves real numbers. If we consider the problem of dividing 10 by 3, we can quote the results in two ways:

$$\begin{array}{ll}
 \mathbf{1.} & \frac{11}{4} = 2 + \frac{3}{4} \\
 \mathbf{2.} & 11 = 4 \times 2 + 3
 \end{array}$$

In either case, ‘11’ is the **dividend**, ‘4’ is the **divisor**, ‘2’ is the **quotient** and ‘3’ is the **remainder**.

We can extend this to include division of polynomials

If $P(x)$ and $D(x)$ are two polynomials over a given field with $\deg P(x) \geq \deg D(x)$ there exist two polynomials $Q(x)$ and $R(x)$ such that

$P(x)$	=	$D(x)$	×	$Q(x)$	+	$R(x)$
↑		↑		↑		↑
dividend		divisor		quotient		remainder

or $\frac{P(x)}{D(x)} = Q(x) + \frac{R(x)}{D(x)}$ where $0 \leq \deg R(x) < \deg D(x)$.

Nb: If $R(x) = 0$ then $D(x)$ is a **factor** of $P(x)$.

The *process* of polynomial division is the same as that of long division of numbers. For example, when dividing 4 into 11, the long division process is set out as follows:

$$\begin{array}{r}
 2 \text{ (How many 4s go into 11)} \\
 4 \overline{) 11} \\
 \underline{8} \quad (4 \times 2 = 8) \\
 3 \quad (11 - 8 = 3) \text{ [i.e., remainder is 3]}
 \end{array}$$

Therefore, we have that $\frac{11}{4} = 2 + \frac{3}{4}$ or $11 = 4 \times 2 + 3$

We now consider an example that involves division of two polynomials.

EXAMPLE 3.2

Divide $P(x) = x^3 - 4x^2 + 5x - 1$ by $(x - 2)$

S
o
l
u
t
i
o
n

1 “How many times does x go into x^3 , i.e., $x^3 \div x = x^2$ ”

$$\begin{array}{r}
 x^2 \\
 x-2 \overline{) x^3 - 4x^2 + 5x - 1}
 \end{array}$$

2 “Multiply $(x - 2)$ by x^2 , i.e., $x^2 \times (x - 2) = x^3 - 2x^2$ ”

$$\begin{array}{r}
 x^2 \\
 x-2 \overline{) x^3 - 4x^2 + 5x - 1} \\
 \underline{x^3 - 2x^2}
 \end{array}$$

3 “Subtract $x^3 - 2x^2$ from $x^3 - 4x^2 + 5x - 1$,
i.e., $(x^3 - 4x^2 + 5x - 1) - (x^3 - 2x^2) = -2x^2 + 5x - 1$ ”

$$\begin{array}{r}
 x^2 \\
 x-2 \overline{) x^3 - 4x^2 + 5x - 1} \\
 \underline{x^3 - 2x^2} \\
 -2x^2 + 5x - 1
 \end{array}$$

4 “How many times does x go into $-2x^2$, i.e., $-2x^2 \div x = -2x$ ” (i.e., repeat step 1)

$$\begin{array}{r}
 x^2 - 2x \\
 x-2 \overline{) x^3 - 4x^2 + 5x - 1} \\
 \underline{x^3 - 2x^2} \\
 -2x^2 + 5x - 1
 \end{array}$$

5 “Multiply $(x - 2)$ by $-2x$, i.e., $-2x \times (x - 2) = -2x^2 + 4x$ ” (i.e., repeat step 2)

$$\begin{array}{r}
 x^2 - 2x \\
 x-2 \overline{) x^3 - 4x^2 + 5x - 1} \\
 \underline{x^3 - 2x^2} \\
 -2x^2 + 5x - 1 \\
 \underline{-2x^2 + 4x}
 \end{array}$$

6 “Subtract $-2x^2 + 4x$ from $-2x^2 + 5x - 1$, i.e., $(-2x^2 + 5x - 1) - (-2x^2 + 4x) = x - 1$ ”
(i.e., repeat step 3)

$$\begin{array}{r}
 x^2 - 2x \\
 x-2 \overline{) x^3 - 4x^2 + 5x - 1} \\
 \underline{x^3 - 2x^2} \\
 -2x^2 + 5x - 1 \\
 \underline{-2x^2 + 4x} \\
 x - 1
 \end{array}$$

- 7 “How many times does x go into x , i.e., $x \div x = 1$ ” (i.e., repeat step 1)

$$\begin{array}{r}
 x^2 - 2x + 1 \\
 x-2 \overline{) x^3 - 4x^2 + 5x - 1} \\
 \underline{x^3 - 2x^2} \\
 -2x^2 + 5x - 1 \\
 \underline{-2x^2 + 4x} \\
 x - 1
 \end{array}$$

- 8 “Multiply $(x-2)$ by 1, i.e., $1 \times (x-2) = x-2$ ” (i.e., repeat step 2)

$$\begin{array}{r}
 x^2 - 2x + 1 \\
 x-2 \overline{) x^3 - 4x^2 + 5x - 1} \\
 \underline{x^3 - 2x^2} \\
 -2x^2 + 5x - 1 \\
 \underline{-2x^2 + 4x} \\
 x - 1 \\
 \underline{x - 2} \\
 1
 \end{array}$$

- 6 “Subtract $(x-2)$ from $(x-1)$, i.e., $(x-1) - (x-2) = 1$ ” (i.e., repeat step 3)

$$\begin{array}{r}
 x^2 - 2x + 1 \\
 x-2 \overline{) x^3 - 4x^2 + 5x - 1} \\
 \underline{x^3 - 2x^2} \\
 -2x^2 + 5x - 1 \\
 \underline{-2x^2 + 4x} \\
 x - 1 \\
 \underline{x - 2} \\
 1
 \end{array}$$

And so, we have that $P(x) = (x-2)(x^2 - 2x + 1) + 1$ or $\frac{P(x)}{x-2} = x^2 - 2x + 1 + \frac{1}{x-2}$.

That is, we have a quotient $x^2 - 2x + 1$ and remainder 1.

Note that we are always dividing the current expression by the highest degree term in the divisor, $(x-2)$. Also note that the process is stopped when the degree of the current dividend becomes less than that of the divisor, i.e. $\deg(1) < \deg(x-2)$.

Although the process seems to be very long, after a little practice you will be able to carry out the process efficiently.

EXAMPLE 3.3

Divide $2x^3 + 5x^2 - 13$ by $2x^2 + x - 2$.

$$\begin{array}{r}
 2x^2 + x - 2 \overline{) 2x^3 + 5x^2 - 0x - 13} \\
 \underline{2x^3 + x^2 - 2x} \\
 4x^2 + 2x - 13 \\
 \underline{4x^2 + 2x - 4} \\
 -9
 \end{array}$$

$2x^3 \div 2x^2 = x$ ①
 $x + 2 \rightarrow 4x^2 + 2x^2 = 2$ ④
 $x \times (2x^2 + x - 2)$ ②
 $2x^3 + 5x^2 - 0x - 13 - (2x^3 + x^2 - 2x)$ ③
 $2 \times (2x^2 + x - 2)$ ⑤
 $4x^2 + 2x - 13 - (4x^2 + 2x - 4)$ ⑥

We note that $\deg(-9) = 0$ and $\deg(2x^2 + x - 2) = 2$. Then, as $\deg(-9) < \deg(2x^2 + x - 2)$ we stop the division process at this stage.

$$\therefore 2x^3 + 5x^2 - 13 = (2x^2 + x - 2)(x + 2) - 9 \text{ or } \frac{2x^3 + 5x^2 - 13}{2x^2 + x - 2} = x + 2 + \frac{-9}{2x^2 + x - 2}.$$

That is, the quotient is $(x + 2)$ and the remainder is -9 .

Notice also how we have created a ‘place holder’ by including ‘0x’ in the dividend term of our division process. This helps avoid arithmetic mistakes when subtracting terms.

Notice that it is not always the case that there is a constant remainder (although that will be true whenever we divide a polynomial by a linear polynomial). For example, dividing the polynomial $2x^4 + 3x^3 + 5x^2 - 13$ by the quadratic $2x^2 + x - 2$ we obtain

$$\frac{2x^4 + 3x^3 + 5x^2 - 13}{2x^2 + x - 2} = x^2 + x + 3 - \frac{x + 7}{2x^2 + x - 2}$$

So that this time the remainder is a linear polynomial, $-x - 7$.

EXERCISES 3.1

1. Given the polynomials $P(x) = x^4 - x^3 + 2x - 1$, $Q(x) = 3 - x + 2x^3$ and $T(x) = 3x^2 - 2$ evaluate
 - (a) $2T(x) - Q(x)$
 - (b) $P(x) + 4T(x)$
 - (c) $T(x) \times Q(x)$
 - (d) $P(x)Q(x)$
 - (e) $[Q(x)]^2$
 - (f) $[T(x)]^2 - 9P(x)$
2. Divide $3x^2 - 2x + 1$ by $(x - 1)$
3. Divide $4x^3 - 8x^2 + 25x - 19$ by $(2x - 1)$
4. Divide $x^4 - 3x^3 + x + 4$ by $x^2 - 2x + 3$
5. Divide $2x^3 - 5x^2 - 10$ by $(x + 1)$
6. Divide $x^4 + 2x^2 - x$ by $x^2 + 3$
7. Divide $12 + 19x - 7x^2 - 6x^3$ by $(3x - 1)$
8. When $x^3 - 2x + k$ is divided by $(x - 2)$ it leaves a remainder of 5, find k .
9. When $x^3 - 2x + k$ is divided by $(x + 1)$ it leaves a remainder of 0, find k .
10. When $2x^3 - x^2 + kx - 4$ is divided by $(x + 2)$ it leaves a remainder of 0, find k .
11. When $2x^3 - x^2 + kx - 4$ is divided by $(x - 1)$ it leaves a remainder of 2, find k .

3.2 SYNTHETIC DIVISION

Suppose that the polynomial, $A(x) = a_3x^3 + a_2x^2 + a_1x + a_0$ is divided by $(x - k)$ so that it results in a quotient $Q(x) = b_2x^2 + b_1x + b_0$ and a constant remainder R . Then, we can write

this result as
$$\frac{A(x)}{x-k} = Q(x) + \frac{R}{x-k} \text{ or } A(x) = (x-k)Q(x) + R$$

Substituting the polynomial terms into the second form we have:

$$a_3x^3 + a_2x^2 + a_1x + a_0 = (x-k)(b_2x^2 + b_1x + b_0) + R$$

$$\Leftrightarrow a_3x^3 + a_2x^2 + a_1x + a_0 = b_2x^3 + (b_1 - kb_2)x^2 + (b_0 - kb_1)x + (R - kb_0)$$

Then, equating the coefficients on both sides of the equation, we have:

$$\begin{aligned} a_3 &= b_2 & \Rightarrow b_2 &= a_3 \\ a_2 &= b_1 - kb_2 & \Rightarrow b_1 &= a_2 + kb_2 = a_2 + ka_3 \\ a_1 &= b_0 - kb_1 & \Rightarrow b_0 &= a_1 + kb_1 \\ a_0 &= R - kb_0 & \Rightarrow R &= a_0 + kb_0 \end{aligned}$$

Given the ‘recursive’ nature of this result we can set it up in a table form as follows

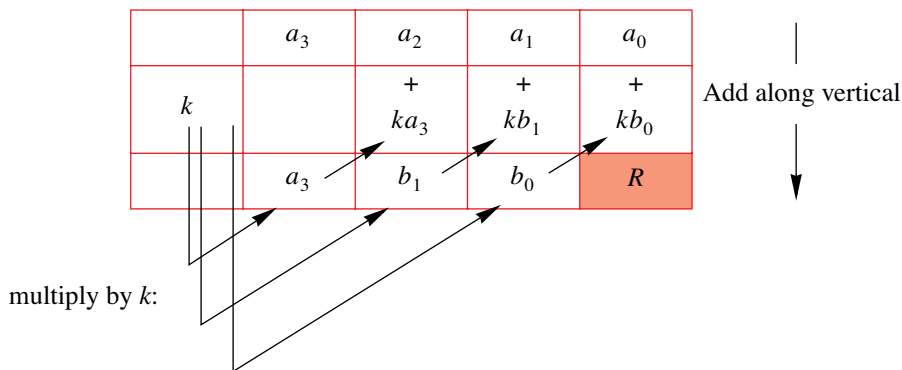

Although we have only shown the process for a polynomial of degree 3, this works for any polynomial. This quick method of dividing polynomials by $(x - k)$ is known as **synthetic division**. This method relies on the relationships between the coefficients of x in the product of the quotient and divisor.

EXAMPLE 3.4

Divide $x^3 + 2x^2 - 3x + 4$ by $(x - 2)$

Solution The coefficients of the polynomial are: 1 2 -3 4 and the value of k is 2.
Setting up the table to make use of synthetic division we have:

	1	2	-3	4
2				

The next step is to place the leading coefficient in the last row:

	1	2	-3	4
2				
	1			

Then, we multiply 1 by 2 (i.e., k) giving an answer of 2 and placing as shown:

	1	2	-3	4
2		2		
	1			

Next, add $2 + 2 = 4$ as shown:

	1	2	-3	4
2		2		
	1	4		

Multiply 4 by 2 (i.e., k) giving an answer of 8 and placing as shown:

	1	2	-3	4
2		2	8	
	1	4		

Next, add $-3 + 8 = 5$ as shown:

	1	2	-3	4
2		2	8	
	1	4	5	

Multiply 5 by 2 (i.e., k) giving an answer of 10 and placing as shown:

	1	2	-3	4
2		2	8	10
	1	4	5	

Next, add $4 + 10 = 14$ as shown:

	1	2	-3	4
2		2	8	10
	1	4	5	14

Then, the coefficients in the last row are the coefficients of the quotient and the last number corresponds to the remainder. This means that the quotient has a constant term of 5, the coefficient of x is 4, the coefficient of x^2 is 1 and has a remainder of 14.

Therefore, we have that $\frac{x^3 + 2x^2 - 3x + 4}{x - 2} = x^2 + 4x + 5 + \frac{14}{x - 2}$.

EXAMPLE 3.5

Divide $3x^5 - 8x^4 + x^2 - x + 3$ by $(x - 2)$.

S
o
l
u
t
i
o
n

We can now ‘fast track’ the process into one table. Using the coefficients of the polynomial in the top row we have:

	3	-8	0	1	-1	3
2		6	-4	-8	-14	-30
	3	-2	-4	-7	-15	-27

And so $\frac{3x^5 - 8x^4 + x^2 - x + 3}{x - 2} = 3x^4 - 2x^3 - 4x^2 - 7x - 15 - \frac{27}{x - 2}$

or $3x^5 - 8x^4 + x^2 - x + 3 = (x - 2)(3x^4 - 2x^3 - 4x^2 - 7x - 15) - 27$

E **EXAMPLE 3.6**

Divide $2x^4 + x^3 - x^2 + 5x + 1$ by $(x + 3)$.

S
o
l
u
t
i
o
n

Constructing the appropriate table with the coefficients 2; 1; -1; 5; 1 in the first row and with $k = -3$, we have:

	2	1	-1	5	1
-3		-6	15	-42	111
	2	-5	14	-37	112

And so $\frac{2x^4 + x^3 - x^2 + 5x + 1}{x + 3} = 2x^3 - 5x^2 + 14x - 37 + \frac{112}{x + 3}$

or $2x^4 + x^3 - x^2 + 5x + 1 = (x + 3)(2x^3 - 5x^2 + 14x - 37) + 112$

In Example 3.6, had we wanted to divide by $(2x - 3)$ then, we would have used $k = \frac{3}{2}$. The

reason being that $2x - 3 = 2\left(x - \frac{3}{2}\right)$ and to use synthetic division, we must divide by $x - k$. This

also means that if we had divided by $(2x + 3)$ then $k = -\frac{3}{2}$.

E **EXERCISES 3.2**

Use Synthetic Division to find the quotients and remainders below.

- $2x^2 - 5x + 1 \div (x - 1)$
- $3x^3 + x^2 - x + 3 \div (x - 3)$
- $2x^4 - x^3 - 2x^2 + 3 \div (x + 3)$
- $2x^3 - 5x^2 + 10x - 3 \div (2x - 1)$
- $2x^4 + 3x^2 - x \div (x + 2)$
- $5 - 2x^2 - x^4 \div (4 - x)$

3.3 THE REMAINDER THEOREM

For any polynomial $P(x)$, the remainder when divided by $(x - \alpha)$ is $P(\alpha)$.

PROOF

The degree of the remainder $R(x)$ must be less than the degree of the divisor $D(x)$. Therefore if $D(x)$ has degree = 1, $R(x)$ has degree = 0 and is therefore constant.

$$\begin{aligned} \therefore \text{ if } P(x) &= D(x) \times Q(x) + R \text{ and } D(x) = (x - \alpha) \text{ then} \\ P(x) &= (x - \alpha) Q(x) + R \quad (\text{where } R \text{ is a constant}) \end{aligned}$$

$$\text{when } x = \alpha, \quad P(\alpha) = (\alpha - \alpha) Q(\alpha) + R$$

$$\therefore P(\alpha) = R$$

i.e. the remainder on division of $P(x)$ by $(x - \alpha)$ is $P(\alpha)$.

We start by considering Examples 3.2 and 3.6.

Example 3.2: With $P(x) = x^3 - 4x^2 + 5x - 1$ and the divisor $(x - 2)$, we have

$$P(2) = (2)^3 - 4(2)^2 + 5(2) - 1 = 8 - 16 + 10 - 1 = 1$$

$$\text{So, } P(2) = 1 \Rightarrow \text{remainder is } 1$$

Which agrees with the remainder we had obtained.

Example 3.6: With $P(x) = 2x^4 + x^3 - x^2 + 5x + 1$ and the divisor $(x + 3)$, we have

$$\begin{aligned} P(-3) &= 2(-3)^4 + (-3)^3 - (-3)^2 + 5(-3) + 1 \\ &= 112 \end{aligned}$$

$$\text{So, } P(-3) = 112 \Rightarrow \text{remainder is } 112$$

Which agrees with the remainder we had obtained.

Because of the nature of the arithmetic involved in evaluating such problems it is a good idea to make use of a graphics calculator. Using the TI-83 we first enter the equation and then evaluate the polynomial using the required value of k :

Example 3.2

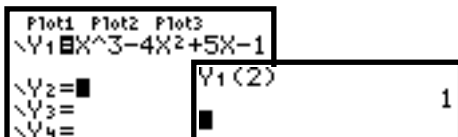

Example 3.6

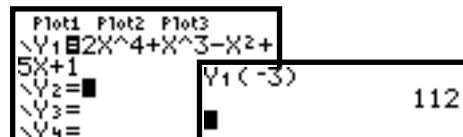

EXAMPLE 3.7

Find the remainder when $P(x) = x^3 + x^2 - x + 1$ is divided by $(x + 1)$.

S
o
l
u
t
i
o
n

$$P(x) = x^3 + x^2 - x + 1$$

$$\begin{aligned} P(-1) &= (-1)^3 + (-1)^2 - (-1) + 1 \\ &= 2 \end{aligned}$$

\therefore the remainder when $P(x)$ is divided by $(x + 1)$ is 2.

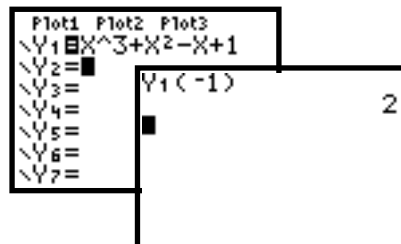

EXAMPLE 3.8

Find the remainders when $P(x) = 3x^3 - 2x^2 + 7x - 4$ is divided by:

- (a) $(x - 1)$ (b) $(x + 3)$ (c) $(3x - 2)$ (d) $(2x + 1)$

S
o
l
u
t
i
o
n

Let R be the remainder in each case.

- (a) $R = P(1) = 3(1)^3 - 2(1)^2 + 7(1) - 4 = 4$
 (b) $R = P(-3) = 3(-3)^3 - 2(-3)^2 + 7(-3) - 4 = -124$
 (c) $R = P\left(\frac{2}{3}\right) = 3\left(\frac{2}{3}\right)^3 - 2\left(\frac{2}{3}\right)^2 + 7\left(\frac{2}{3}\right) - 4 = \frac{2}{3}$
 (d) $R = P\left(-\frac{1}{2}\right) = 3\left(-\frac{1}{2}\right)^3 - 2\left(-\frac{1}{2}\right)^2 + 7\left(-\frac{1}{2}\right) - 4 = -\frac{67}{8}$

Using the TI-83 we have:

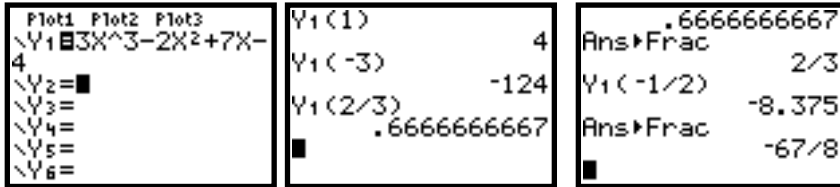

EXERCISES 3.3

- Find the remainder when
 - $P(x) = -x^3 + 2x^2 + 3$ is divided by $(x - 3)$.
 - $Q(x) = 2x^3 - 12x + 7$ is divided by $(x + 2)$.
 - $P(x) = 6 + x - x^2 + 2x^4$ is divided by $(x - 1)$.
 - $P(x) = 4x^3 + 3x^2 - 2x + 1$ is divided by $(2x - 1)$.
 - $Q(x) = x^3 - 4x^2 + x - 3$ is divided by $(3x + 2)$.
- Find the value of k if the remainder of $x^3 + kx^2 - x + 2$ when divided by $x + 2$ is 20.
- Find the remainder when $4x^4 + 3x^2 + 2x - 2$ is divided by
 - $x - 1$
 - $x + 2$
 - $(x - 1)(x + 2)$
- When $2x^3 + ax^2 + bx + 1$ is divided by $(x - 1)$ and $(x - 2)$, the remainders are 4 and 15 respectively. Find the remainder when it is divided by $(x + 1)$.
- Find the value of k if $P(x)$ is exactly divisible by $d(x)$, where
 - $P(x) = x^3 - 6x^2 + kx - 6$ and $d(x) = x - 3$
 - $P(x) = 2x^3 - kx^2 + 1$ and $d(x) = 2x + 1$.

3.4 THE FACTOR THEOREM

$(x - \alpha)$ is a factor of $P(x)$ if and only if $P(\alpha) = 0$

That is, if $(x - \alpha)$ is a **factor** of $P(x)$ then the **remainder** $R = P(\alpha) = 0$.

And, if $P(\alpha) = 0$ then $(x - \alpha)$ is a **factor** of $P(x)$.

PROOF

By the remainder theorem, $P(x) = (x - \alpha) \times Q(x) + R$ for all real x

$$\therefore P(\alpha) = R$$

but if $P(\alpha) = 0$ i.e. $R = 0$ then $P(x) = (x - \alpha)Q(x) + 0$
 $= (x - \alpha)Q(x)$

i.e. $(x - \alpha)$ is a factor of $P(x)$

EXAMPLE 3.9

Determine which of $(x - 3)$, $(x - 1)$, $(x + 2)$ are factors of

$P(x) = 2x^3 + 7x^2 + 7x + 2$, and hence factorise $P(x)$ completely.

S
o
l
u
t
i
o
n

For $(x - 3)$, $P(3) = 2(3)^3 + 7(3)^2 + 7(3) + 2 \neq 0$, thus $(x - 3)$ is not a factor of $P(x)$.

For $(x - 1)$, $P(1) = 2(1)^3 + 7(1)^2 + 7(1) + 2 \neq 0$, thus $(x - 1)$ is not a factor of $P(x)$

For $(x + 2)$, $P(-2) = 2(-2)^3 + 7(-2)^2 + 7(-2) + 2 = 0$, thus $(x + 2)$ is a factor of $P(x)$

Next, we divide $(x + 2)$ into $2x^3 + 7x^2 + 7x + 2$:

	2	7	7	2
-2		-4	-6	-2
	2	3	1	0

Giving a quotient of $2x^2 + 3x + 1$.

$$\begin{aligned} \text{Therefore, } 2x^3 + 7x^2 + 7x + 2 &= (x + 2)(2x^2 + 3x + 1) \\ &= (x + 2)(2x + 1)(x + 1) \end{aligned}$$

EXAMPLE 3.10

Determine m and n so that $3x^3 + mx^2 - 5x + n$ is divisible by both $(x - 2)$ and $(x + 1)$. Factorise the resulting polynomial completely.

S
o
l
u
t
i
o
n

By the factor theorem, $(x - \alpha)$ is a factor of $P(x)$ if $P(\alpha) = 0$

$$\therefore P(2) = 24 + 4m - 10 + n$$

As $P(2) = 0$, we have that $24 + 4m - 10 + n = 0$

$$\text{i.e. } 4m + n = -14 \quad (1)$$

$$P(-1) = -3 + m + 5 + n$$

As $P(-1) = 0$, we have that $-3 + m + 5 + n = 0$

$$\text{i.e. } m + n = -2 \quad (2)$$

Solving (1) and (2) simultaneously we have:

$$(1) - (2): \quad 3m = -12 \therefore m = -4$$

MATHEMATICS – Higher Level (Core)

Substituting into (2): $-4 + n = -2 \therefore n = 2$

Hence $P(x) = 3x^3 - 4x^2 - 5x + 2$.

As we already know that $(x + 1)$ and $(x - 2)$ are factors of $P(x)$, we also have that $(x + 1)(x - 2)$ is a factor of $P(x)$. All that remains then is to find the third factor. As the third factor is also a linear term, we use the general linear term $(ax + b)$ and determine the value of a and b .

We write our polynomial as $P(x) = (x + 1)(x - 2)(ax + b)$.

To find a and b we look at the coefficient of x^3 and the constant term.

i.e., $P(x) = (x^2 - x - 2)(ax + b) = (ax^3 + \dots - 2b)$.

Then, as $P(x) = 3x^3 - 4x^2 - 5x + 2$ we have that $3x^3 - 4x^2 - 5x + 2 \equiv ax^3 + \dots - 2b$.

Meaning that, $3 = a$ and $2 = -2b \Leftrightarrow b = -1$.

$$\therefore 3x^3 - 4x^2 - 5x + 2 = (x + 1)(x - 2)(3x - 1)$$

In the last Example we made use of the ‘identically equivalent to’ notation, i.e., ‘ \equiv ’. You need to be aware that this is not the same as when we use the equality sign, ‘ $=$ ’.

For example, we have that $(x + 2)^2 \equiv x^2 + 4x + 4$, because this statement will be true for any value of x . However, we **cannot** have that $(x + 2)^2 \equiv x^2 + 3x + 4$, because this will not be true for all values of x . In fact it will only be true for one value of x (namely, $x = 0$). In such situations what we really want to know is ‘For what value(s) of x will $(x + 2)^2 = x^2 + 3x + 4$?’ Meaning that we need to solve for x . Notice then that when we use the ‘ $=$ ’ sign we really want to solve for the unknown whereas when we use the ‘ \equiv ’ sign we are making a statement.

Having said this, the distinction between ‘ \equiv ’ and ‘ $=$ ’ is not always adhered to when presenting a mathematical argument. So, when expanding the term $(x + 2)^2$, rather than writing $(x + 2)^2 \equiv x^2 + 4x + 4$, more often than not, it will be written as $(x + 2)^2 = x^2 + 4x + 4$. In these situations, the meaning attached to the ‘ $=$ ’ sign will be clear from the context of the problem.

A useful extension of the factor theorem allows us to find factors of any polynomial $P(x)$, if they exist.

Given a polynomial $P(x) = a_n x^n + a_{n-1} x^{n-1} + \dots + a_1 x + a_0$, then $P(x)$ has a factor $(px - q)$ if and only if p is a factor of a_n and q is a factor of a_0 .

This result is useful in helping us guess potential factors of a given polynomial. For example, given a polynomial $P(x) = 2x^3 - 3x^2 + 1$, we would try (as potential factors) the following $(2x + 1)$, $(2x - 1)$, $(x - 1)$ and $(x + 1)$.

EXAMPLE 3.11

Factorise the polynomial $T(x) = x^3 - 3x^2 + 4$.

S
o
l
u
t
i
o
n

$T(x)$ can be factorised if we can find a factor $(px - q)$ where p is a factor of 1 and q is a factor of 4.

Factors of 1 are 1×1 and factors of 4 are $\pm 1 \times \pm 4$ and $\pm 2 \times \pm 2$, so possible factors of $T(x)$ are $(x \pm 1)$, $(x \pm 2)$, and $(x \pm 4)$.

Using the factor theorem;

for $(x - 1)$, $T(1) = 1 - 3 + 4 \neq 0$, thus $(x - 1)$ is **not a factor** of $T(x)$

for $(x + 1)$, $T(-1) = -1 - 3 + 4 = 0$, thus $(x + 1)$ is **a factor** of $T(x)$.

Having found one factor it is now possible to divide $T(x)$ by $(x + 1)$ to find all other factors. Using synthetic division we have:

	1	-3	0	4
-1		-1	4	-4
	1	-4	4	0

$$\begin{aligned} \text{Therefore, } x^3 - 3x^2 + 4 &= (x + 1)(x^2 - 4x + 4) \\ &= (x + 1)(x - 2)^2 \end{aligned}$$

EXAMPLE 3.12

Factorise $P(x) = 2x^3 - 5x^2 + x + 3$.

S
o
l
u
t
i
o
n

Let $(px - q)$ be a factor of $P(x)$ where p is a factor of 2, and q is a factor of 3.

Factors of 2 are 1×2 , and factors of 3 are 1×3 or -1×-3 thus possible factors of $P(x)$ are $(x \pm 1)$, $(x \pm 3)$, $(2x \pm 1)$, $(2x \pm 3)$.

Using the factor theorem with each of these leads to $(2x - 3)$ as a factor of $P(x)$. Of course, using the TI-83 makes life easier:

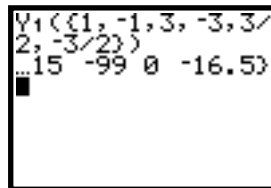
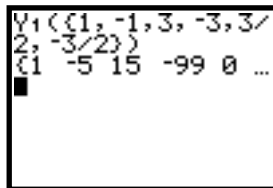
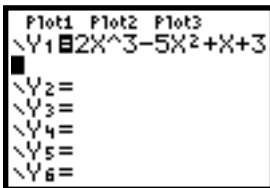

From the above screens we see that $P\left(\frac{3}{2}\right) = 0 \Leftrightarrow (2x - 3)$ is a factor.

Then dividing $P(x)$ by $(2x - 3)$ gives: $2x^3 - 5x^2 + x + 3 = (2x - 3)(x^2 - x - 1)$.

Next, $x^2 - x - 1 = \left(x^2 - x + \frac{1}{4}\right) - \frac{1}{4} - 1 = \left(x - \frac{1}{2}\right)^2 - \frac{5}{4} = \left(x - \frac{1}{2} - \frac{\sqrt{5}}{2}\right)\left(x - \frac{1}{2} + \frac{\sqrt{5}}{2}\right)$.

Therefore, $P(x) = (2x - 3)\left(x - \frac{1}{2} - \frac{\sqrt{5}}{2}\right)\left(x - \frac{1}{2} + \frac{\sqrt{5}}{2}\right)$

EXAMPLE 3.13

Factorise $P(x) = 2x^3 - 3x^2 - 29x - 30$.

Solution

We start by ‘guessing’ factors:

Note that we have not tried all possible combinations, just enough to get the first factor.

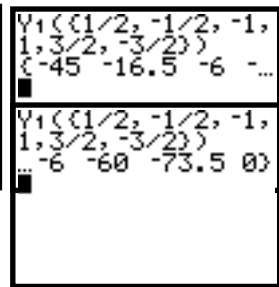
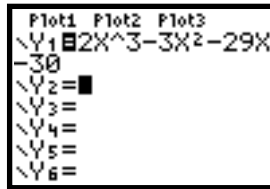

Then, as $P\left(-\frac{3}{2}\right) = 0$, $(2x + 3)$ is a factor.

Using synthetic division we next have:

	2	-3	-29	-30
$-\frac{3}{2}$		-3	9	30
	2	-6	-20	0

Therefore, $P(x) = \frac{1}{2}(2x + 3)(2x^2 - 6x - 20)$ Nb: we have $\frac{1}{2}$, because of the $2\left(x + \frac{3}{2}\right)$ term.

$$= \frac{1}{2}(2x + 3)(2x - 10)(x + 2)$$

$$= (2x + 3)(x - 5)(x + 2)$$

Although we will look at sketching polynomials later on in this chapter, it is worthwhile mentioning at this point that we can reduce the ‘guessing game’ when looking for factors by looking at where the graph of the polynomial cuts the x -axis.

In Example 3.11, using a graphics calculator to sketch the graph of $T(x) = x^3 - 3x^2 + 4$ gives:

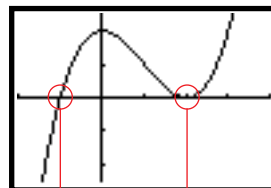
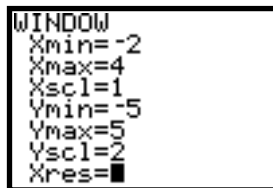
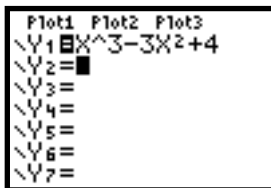

$x = -1$ $x = 2$

This tells us that $T(x) = 0$ when $x = -1$ and $x = 2$, which in turn means that $(x + 1)$ and $(x - 2)$ are both factors of $T(x)$. In fact, given that the curve touches at $x = 2$, it also tells us that we have a repeated factor, i.e., there are two factors $(x - 2)$. From this information and the fact that the leading coefficient is one, we can then write $T(x) = (x + 1)(x - 2)^2$.

If the leading coefficient was not one, we would have to write $T(x) = k(x + 1)(x - 2)^2$. Why?

EXERCISES 3.4

- 1.** Factorise fully, the following polynomials
- (a) $x^3 - 19x + 30$ (b) $x^3 + x^2 - x - 10$
 (c) $x^3 - x^2 - 4x + 4$ (d) $3x^3 + x^2 - 12x - 4$
 (e) $2x^3 - x^2 - 18x + 9$ (f) $x^4 - 3x^2 - 6x + 8$
 (g) $x^3 - x^2 - 8x + 12$ (h) $5x^3 - 24x^2 + 36x - 16$
 (i) $40 - 19x^2 + 94x - 10x^3$ (j) $-5x^3 - 9x^2 - 3x + 1$

MISCELLANEOUS EXERCISES

- 2.** The polynomial $P(x)$ is divided by $2x^2 - 1$, resulting in a quotient $3x - 2$ and a remainder $(x + 1)$. Find $P(x)$.
- 3.** Find the remainder when $2x^4 - 2x^2 + x - 5$ is divided by $(2x + 1)$.
- 4.** Find the remainder when $p(x) = x^3 + 2x^2 - 11x - 12$ is divided by $(x + 4)$. Hence factorise $p(x)$.
- 5.** Factorise $g(x) = 2x^3 + 9x^2 + 12x + 4$.
- 6.** Factorise $m(x) = x^3 - 4x^2 - 3x - 10$.
- 7.** Factorise $f(x) = 6x^4 - 11x^3 + 2x^2 + 5x - 2$. Noting that $f(x) = 0$ represents the points where $f(x)$ crosses or touches the x -axis, sketch the graph of $f(x)$.
- 8.** (a) Factorise the polynomial $2 - 13x + 23x^2 - 3x^3 - 9x^4$.
 (b) Find all values of x for which $2 - 13x + 23x^2 - 3x^3 - 9x^4 = 0$.
 (c) Sketch the graph of the polynomial $q(x) = 2 - 13x + 23x^2 - 3x^3 - 9x^4$.
- 9.** Find the values of a and b if $6x^3 + 7x^2 + ax + b$ is divisible by $(2x - 1)$ and $(x + 1)$.
- 10.** Show that the graph of $y = 2x^3 - 3x^2 + 6x + 4$ cuts the x -axis at only one point.
- 11.** $x^3 + ax^2 - 2x + b$ has $(x + 1)$ as a factor, and leaves a remainder of 4 when divided by $(x - 3)$. Find a and b .
- 12.** Show that $p(x) = 2x^3 - 5x^2 - 9x - 1$ has no factors of the form $(x - k)$, where k is an integer.
- 13.** Given that $(x - 1)$ and $(x - 2)$ are factors of $6x^4 + ax^3 - 17x^2 + bx - 4$, find a and b , and any remaining factors.
- 14.** A cubic polynomial gives remainders $(5x + 4)$ and $(12x - 1)$ when divided by $x^2 - x + 2$ and $x^2 + x - 1$ respectively. Find the polynomial.

MATHEMATICS – Higher Level (Core)

- 15.** A cubic polynomial gives remainders $(13x - 2)$ and $(-1 - 7x)$ when divided by $x^2 - x - 3$ and $x^2 - 2x + 5$ respectively. Find the polynomial.
- 16.** Given that $x + 1$ is a factor of $ax^3 + bx^2 + cx + d$, find the relationship between a, b, c and d .
- 17.** Given that $x - 3$ is a factor of $P(x) = x^3 + kx^2 - x - 6$, find the remainder when $P(x)$ is divided by $x - 2$.
- 18.** Given that $x^3 \equiv a(x + 1)^3 + b(x + 1)^2 + c(x + 1) + d$, find the values of a, b, c and d .
- 19.** Factorise the polynomial $T(x) = ax^3 - 5x^2 + bx - 4$ given that when divided by $x + 1$ it leaves a remainder of -3 and that $x - 2$ is a factor.
- 20.** Given that $P(x) = 2x^4 + mx^3 - nx^2 - 7x + k$ is divisible by $(x - 2)$ and $(x + 3)$ and leaves a remainder of -18 when divided by $(x + 1)$.
- (a) Solve for m, n and k .
- (b) Hence, find all linear factors of $P(x)$.
- 21.** $P(x) = x^3 + mx^2 + nx + k$ is divisible by $x^2 - 4$ and leaves a remainder of 30 when divided by $(x - 3)$. Solve for m, n and k and hence fully factorise $P(x)$ into its three linear factors.
- 22.** The remainders when $T(x) = kx^n - 3x^2 + 6$ is divided by $(x - 1)$ and $(x + 2)$ are 1 and 10 respectively. Find k and n .
- 23.** Show that if $P(x) = x^4 + mx^2 + nx + k^2$ is divisible by $x^2 - 1$, then $P(x) \mid x^2 - k^2$.
- 24.** If the polynomial $P(x) = x^2 + ax + 1$ is a factor of $T(x) = 2x^3 - 16x + b$, find the values of a and b .
- 25.** The polynomial $P(x) = ax^3 + bx^2 + cx + d$ where a, b, c and d are all integers. If p and q are two relatively prime integers, show that if $(qx - p)$ is a factor of $P(x)$, then p is a factor of d and q is a factor of a .
- 26.** When a polynomial, $P(x)$, is divided by $x - \alpha$, it leaves a remainder of α^3 and when it is divided by $x - \beta$ it leaves a remainder of β^3 . Find the remainder when $P(x)$ is divided by $(x - \alpha)(x - \beta)$.
- 27.** (a) Prove that if $x^3 + mx + n$ is divisible by $(x - k)^2$, then $\left(\frac{m}{3}\right)^3 + \left(\frac{n}{2}\right)^2 = 0$
- (b) Prove that if $x^3 + mx + n$ and $3x^2 + m$ have a common factor $(x - k)$ then $4m^3 + 27n^2 = 0$.
- 28.** Prove that $P(x) = x^n - a^n$ is divisible by $(x - a)$ for all integer values of n .

3.5 EQUATIONS & INEQUATIONS

3.5.1 POLYNOMIAL EQUATIONS

The factor theorem has some very useful consequences, one of which allows us to solve equations of the form $P(x) = 0$.

The expression

$$P(x) = 0 \text{ where } P(x) = a_n x^n + a_{n-1} x^{n-1} + \dots + a_1 x + a_0$$

is called a **polynomial equation**.

The **roots** or **solutions** of this equation are the zeros of $P(x)$.

We have already seen how to solve linear equations, $ax + b = 0$ and quadratic equations, $ax^2 + bx + c = 0$, in Chapter 2. Making use of the factor theorem we can solve (where solutions exist) for a polynomial using the following steps:

- Step 1:** Factorise the polynomial using the factor theorem (if necessary).
- Step 2:** Use the null factor law.
- Step 3:** Solve for the unknown.

EXAMPLE 3.14

Solve $x^3 + 4x^2 + 3x = 0$.

S
o
l
u
t
i
o
n

In this case we start by factoring the 'x' out:

$$x^3 + 4x^2 + 3x = 0 \Leftrightarrow x(x^2 + 4x + 3) = 0$$

$$\Leftrightarrow x(x + 3)(x + 1) = 0 \text{ [factorised polynomial]}$$

$$\Leftrightarrow x = 0 \text{ or } x + 3 = 0 \text{ or } x + 1 = 0 \text{ [Using null factor law]}$$

$$\Leftrightarrow x = 0 \text{ or } x = -3 \text{ or } x = -1 \text{ [Solving for } x\text{]}$$

EXAMPLE 3.15

Solve $2x^3 + 9x^2 + 7x - 6 = 0$.

S
o
l
u
t
i
o
n

Let $P(x) = 2x^3 + 9x^2 + 7x - 6$.

Then, $P(1) = 2 + 9 + 7 - 6 \neq 0$

$$P(-1) = -2 + 9 - 7 - 6 \neq 0$$

$$P(-2) = -16 + 36 - 14 - 6 = 0. \text{ Therefore, } x + 2 \text{ is a factor of } P(x).$$

Using synthetic division we have:

	2	9	7	-6
-2		-4	-10	6
	2	5	-3	0

MATHEMATICS – Higher Level (Core)

$$\begin{aligned}\text{Therefore, } P(x) &= (x+2)(2x^2+5x-3) \\ &= (x+2)(2x-1)(x+3)\end{aligned}$$

$$\begin{aligned}\text{Then, } P(x) = 0 &\Leftrightarrow (x+2)(2x-1)(x+3) = 0 \\ &\Leftrightarrow x+2 = 0 \text{ or } 2x-1 = 0 \text{ or } x+3 = 0 \\ &\Leftrightarrow x = -2 \text{ or } x = \frac{1}{2} \text{ or } x = -3\end{aligned}$$

Again, we can take some of the guess work out of problems such as these by making use of the graphics calculator. In Example 3.15 we could have sketched the graph of $2x^3 + 9x^2 + 7x - 6$ and referred to where it meets the x -axis:

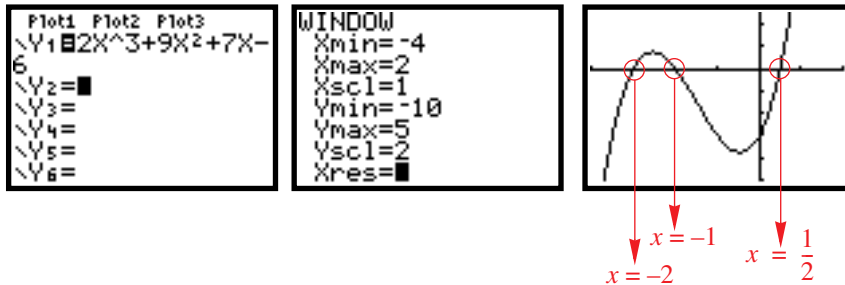

From the graph we have that $P(x) = 0$ at $x = -2$ so that $(x+2)$ is a factor of $P(x)$. From here we can then proceed to use synthetic division, fully factorise $P(x)$ and then solve for x as we did in the example.

In fact, having judiciously selected the settings on the Window screen of the graphics calculator, we have managed to obtain all three solutions without the need of further work!

However, as the next example will show, we cannot always rely on the graphics calculator to determine all the solutions to a polynomial equation.

EXAMPLE 3.16

$$\text{Solve } x^3 - x^2 - 2x + 2 = 0.$$

S
o
l
u
t
i
o
n

We start by using the graphics calculator:

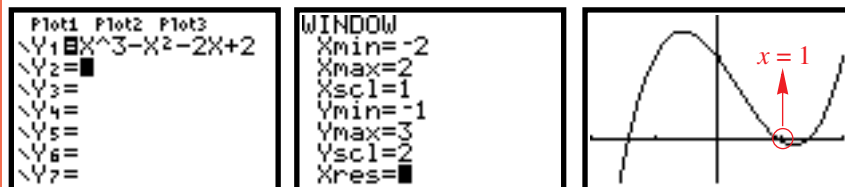

This time we can only obtain one obvious solution to $x^3 - x^2 - 2x + 2 = 0$, namely $x = 1$.

That is, if $P(x) = x^3 - x^2 - 2x + 2$ then $P(1) = 0 \Leftrightarrow x - 1$ is a factor.

$$\begin{aligned}\text{Using synthetic or long division we have } P(x) &= (x-1)(x^2-2) \\ &= (x-1)(x-\sqrt{2})(x+\sqrt{2})\end{aligned}$$

Therefore, $P(x) = 0 \Leftrightarrow (x-1)(x-\sqrt{2})(x+\sqrt{2}) = 0$
 $\Leftrightarrow x = 1$ or $x = \sqrt{2}$ or $x = -\sqrt{2}$.

Note then that the reason we couldn't obtain obvious solutions using the graphics calculator is that the other solutions are irrational.

Also, we need to be careful when setting the Window screen. The settings below could lead to a false assumption (namely that there are repeated roots):

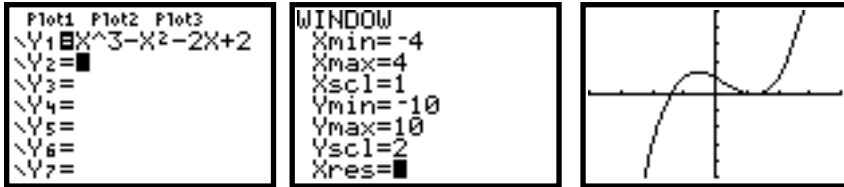

EXAMPLE 3.17

Solve $x^2 + 11 = 6x + \frac{6}{x}$.

S
o
l
v
i
n
g

Solving an equation such as this requires that we first eliminate the fractional part. So, multiplying both sides by x gives:

$$x(x^2 + 11) = x\left(6x + \frac{6}{x}\right) \Leftrightarrow x^3 + 11x = 6x^2 + 6$$

$$\Leftrightarrow x^3 - 6x^2 + 11x - 6 = 0$$

Next we let $P(x) = x^3 - 6x^2 + 11x - 6$, then, either using the graphics calculator or guessing a zero of $P(x)$ we have that $P(1) = 0$ and so, $(x-1)$ is a factor. Then, using synthetic or long division we have,

$$P(x) = (x-1)(x^2 - 5x + 6)$$

$$= (x-1)(x-3)(x-2)$$

Therefore, $x^2 + 11 = 6x + \frac{6}{x} \Leftrightarrow (x-1)(x-3)(x-2) = 0 \therefore x = 1$ or $x = 3$ or $x = 2$.

EXERCISES 3.5.1

1. Solve the following over the real number field.

- | | |
|--------------------------------|-----------------------------------|
| (a) $x^3 + 2x^2 - 5x - 6 = 0$ | (b) $2x^3 - 5x^2 + x + 2 = 0$ |
| (c) $-x^3 + 7x + 6 = 0$ | (d) $6x^3 - 31x^2 + 25x + 12 = 0$ |
| (e) $2x^3 + 3x^2 + 4x - 3 = 0$ | (f) $-x^3 + x^2 + 5x + 3 = 0$ |
| (g) $x^3 + 2x^2 - 7x + 4 = 0$ | (h) $x^3 - 2x^2 - 14x - 12 = 0$ |
| (i) $2x^3 + 9x^2 + 8x + 2 = 0$ | (j) $3x^3 - x^2 - 18x + 6 = 0$ |

MATHEMATICS – Higher Level (Core)

- 2.** Solve the equation $2x^3 - 13x^2 + 16x - 5 = 0$.
- 3.** Solve the equation $4x^3 - 4x^2 - 11x + 6 = 0$.
- 4.** Solve the equation $x^4 - 3x^3 - 3x^2 + 7x + 6 = 0$.
- 5.** Solve the equation $x^4 + x^3 - 9x^2 + 11x - 4 = 0$.
- 6.** (a) Write down the equation of a polynomial with zeros $-2, 3$ and -4 .
(b) Write down the equation of a polynomial with zeros $0.5, 2$ and -1 .
(c) Write down the equation of a polynomial with zeros $0.5, 2$ and -0.5 and a leading coefficient of 8 .
- 7.** Solve the equations
- (a) $6x^2 + x = 19 - \frac{12}{x}$ (b) $x^2 + 7 = x - \frac{1}{x} + \frac{8}{x^2}$
- (c) $\frac{x^2 + 3x}{3x + 4} = \frac{2}{x}$ (d) $\frac{x^2 + 9}{11x^2 + 9} = \frac{1}{2x}$
- 8.** Solve the following to three significant figures
- (a) $2x^3 - 5x + 2 = 0$ (b) $x^3 - 6x^2 + 10x - 6 = 0$
- (c) $x^3 - 2x^2 + 7x - 2 = 0$ (d) $-2x^4 + 6x^2 - 1 = 0$
- 9.** Solve $2x^3 + kx^2 - 11x - 6 = 0$ given that one solution is $x = -3$.
- 10.** Two solutions to the equation $2x^4 + ax^3 + x^2 + 6x + b = 0$ are $x = -3$ and $x = 2$. Find the other two solutions, if they exist.
- 11.** Given that $mx^4 - 5x + n$ and $x^4 - 2x^3 - mx^2 - nx - 8$ are both divisible by $(x - 2)$, solve the equation $x^4 - 9x^3 - 3nx^2 + 4mx + 4mn = 0$.
- 12.** Prove that if the roots of $x^3 - ax^2 + bx - c = 0$ are in arithmetic sequence then $2a^3 - 9ab + 27c = 0$. Hence, find $\{x : x^3 - 12x^2 + 39x - 28 = 0\}$.

3.5.2 POLYNOMIAL INEQUALITIES

As with quadratic inequalities (Chapter 2), we may analogously create polynomial inequations such as $P(x) > 0$, $P(x) \geq 0$, $P(x) < 0$ and $P(x) \leq 0$.

The solution of these inequations is relatively straight forward. After sketching the graph of the given polynomial, we note for which values of x the curve lies above, on or below the x -axis.

The other method is to make use of a **sign diagram**. We can use simple sign diagrams from factorised expressions of polynomials. These are somewhat less useful now because of the ease with which the graphics calculator displays all the relevant information. However, if the polynomial is already factorised then its use is appropriate.

EXAMPLE 3.18

- Find (a) $\{x : x^3 + 3x^2 - 6x - 8 > 0\}$.
 (b) $\{x : (2x - 1)(x + 2)(x - 1) \leq 0\}$.

S
o
l
u
t
i
o
n

- (a) Let $P(x) = x^3 + 3x^2 - 6x - 8$.
 Sketching its graph using the TI-83 we have:

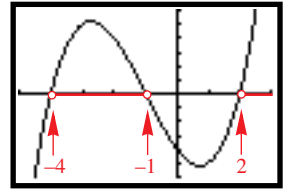

From the graph we see that the curve lies above the x -axis for values of x such that $-4 < x < -1$ and $x > 2$.

$$\therefore \{x : x^3 + 3x^2 - 6x - 8 > 0\} = \{x : -4 < x < -1\} \cup \{x : x > 2\}.$$

- (b) As the polynomial is already factorised, we make use of a sign diagram to solve the inequality.

The zeros of the polynomial $P(x) = (2x - 1)(x + 2)(x - 1)$ are 1, -2 and $\frac{1}{2}$.

Based on the zeros we can construct our sign diagram:

- Test point: Use $x = 0$, $P(0) = (-1)(2)(-1) = 2$.
 i.e., at $x = 0$ $P(x)$ is positive.

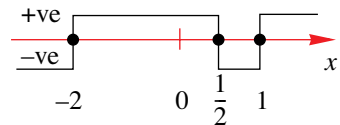

Then, $\{x : (2x - 1)(x + 2)(x - 1) \leq 0\}$ is given by the values of x for which the sign diagram lies below or on the x -axis.

$$\text{That is, } \{x : (2x - 1)(x + 2)(x - 1) \leq 0\} = \{x : x \leq -2\} \cup \left\{x : \frac{1}{2} \leq x \leq 1\right\}.$$

EXERCISES 3.5.2

- 1.** Solve the following inequalities

- | | |
|------------------------------------|-------------------------------------|
| (a) $(x - 1)(x + 1)(x - 2) > 0$ | (b) $(2x - 4)(x + 2)(x - 3) \leq 0$ |
| (c) $(2 - x)(x + 2)(x + 3) \leq 0$ | (d) $x(x - 1)^2 > 0$ |
| (e) $(x + 2)^2(2x + 1) \geq 0$ | (f) $(x^2 - 4)(x + 4) < 0$ |
| (g) $(x - 2)(1 + x)^2(1 - x) < 0$ | (h) $2(x - 3)^2(2 - x) \geq 0$ |

- 2.** Solve the following inequalities

- | | |
|-----------------------------------|-----------------------------------|
| (a) $x^3 + 2x^2 - 5x - 6 > 0$ | (b) $2x^3 - 5x^2 + x + 2 \leq 0$ |
| (c) $-x^3 + 7x + 6 \leq 0$ | (d) $6x^3 - 31x^2 + 25x + 12 > 0$ |
| (e) $2x^3 + 3x^2 + 4x - 3 \geq 0$ | (f) $-x^3 + x^2 + 5x + 3 < 0$ |
| (g) $x^3 + 2x^2 + 4 < 7x$ | (h) $x^3 - 2x^2 - 14x \geq 12$ |
| (i) $2x^3 + 9x^2 + 8x + 2 \leq 0$ | (j) $3x^3 - x^2 + 6 < 18x$ |
| (k) $4x^3 - 5x^2 + 3x \leq 2$ | (l) $x^4 + 5x > 3x^3 + 3$ |

3.6 SKETCHING POLYNOMIALS

3.6.1 GRAPHICAL SIGNIFICANCE OF ROOTS

We have already been making use of the graphs of polynomial functions to help us during this chapter. We are now in a position where we can sketch the graphs of polynomial functions as well as give meaning to the geometrical relationship between the polynomial expression and its graph. In particular we are interested in the geometrical significance of the roots of a polynomial.

The relationship between the roots of a polynomial and its graph can be summarised as follows:

If the polynomial $P(x)$ is factorised into unique (single) factors, $(x - a)$, $(x - b)$, $(x - c)$, ... so that

$$P(x) = (x - a)(x - b)(x - c)\dots, \text{ where } a \neq b \neq c \neq \dots,$$

the curve will **cut the x -axis** at each of the points $x = a, x = b, x = c, \dots$

That is, at each of these points the curve will look like one of



If the polynomial $P(x)$ is factorised and has a repeated (squared) factor, $(x - a)^2$, and unique factors $(x - b)$, $(x - c)$, ... so that

$$P(x) = (x - a)^2(x - b)(x - c)\dots, \text{ where } a \neq b \neq c \neq \dots,$$

the curve will **touch the x -axis** at $x = a$ and cut the x -axis at each of the other points $x = b, x = c, \dots$

That is, at $x = a$ the curve will look like one of

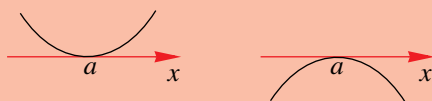

If the polynomial $P(x)$ is factorised and has a repeated (cubed) factor, $(x - a)^3$, and unique factors $(x - b)$, $(x - c)$, ... so that

$$P(x) = (x - a)^3(x - b)(x - c)\dots, \text{ where } a \neq b \neq c \neq \dots,$$

the curve will **cut the x -axis** at $x = a$ but with a change in concavity, i.e., there will be a **stationary point of inflection** at $x = a$ and it will cut the x -axis at each of the other points $x = b, x = c, \dots$

That is, at $x = a$ the curve will look like one of

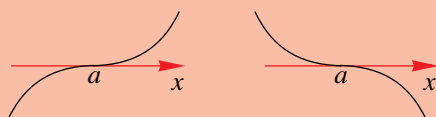

3.6.2 CUBIC FUNCTIONS

A cubic function has the general form $f(x) = ax^3 + bx^2 + cx + d$, $a \neq 0$, $a, b, c, d \in \mathbb{R}$.

We first consider the polynomial $f(x) = ax^3$.

For $a > 0$ we have:

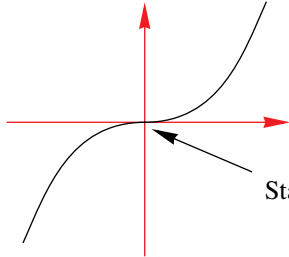

For $a < 0$ we have:

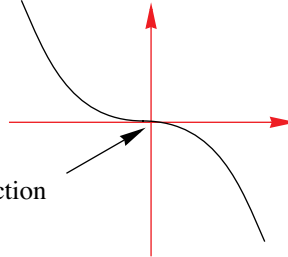

Stationary point of inflection

All other cubic polynomials with real coefficients can be factorised into one of the following forms:

$P(x) = a(x - k)^3$	i.e., 3 identical real zeros, meaning three equal roots, and so, a stationary point of inflection at $x = k$.
$P(x) = a(x - k)^2(x - m)$	i.e., 2 identical real zeros and one other real zero, meaning two equal roots and a third different root, so that at $x = k$ there is a turning point on the x -axis.
$P(x) = a(x - k)(x - m)(x - n)$	i.e., 3 distinct real zeros, meaning three different roots, and so the curve will cut the x -axis at three different points on the x -axis.
$P(x) = a(x - k)(x^2 + px + q)$	i.e., 1 real zero and an irreducible real quadratic, meaning that there is only one root and so the curve cuts the x -axis at only one point, $x = k$.

Some examples are shown below.

$$P(x) = a(x - 4)(x - 8)(x + 1) \quad P(x) = a(x - 1)^2(x - 4) \quad P(x) = a(x - 3)(x^2 + 4x + 5)$$

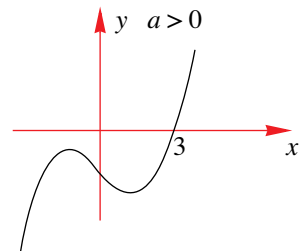
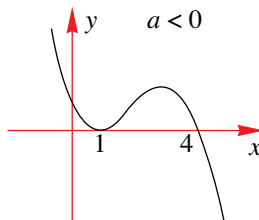
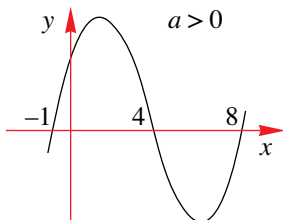

$$P(x) = x^3 + 4x - 2$$

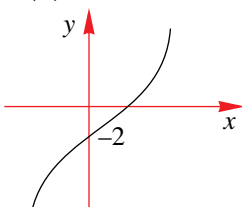

Notice that in this case we cannot factorise the cubic into rational linear factors. The x -intercept can be found using the TI-83 ($x = 0.4735$ to 4 d.p.)

MATHEMATICS – Higher Level (Core)

The key to sketching polynomials is to first express them (where possible) in factored form. Once that is done we can use the results of §3.6.1. Of course, although we have only looked at the cubic function in detail, the results of §3.6.1 hold for polynomials of higher order than three.

EXAMPLE 3.19

- Sketch the graph of
- (a) $P(x) = (x - 1)(x - 3)(x + 1)$.
 - (b) $P(x) = (x - 1)^2(x + 3)$.
 - (c) $P(x) = (2 - x)^3$.

S
o
l
u
t
i
o
n

- (a) The polynomial $P(x) = (x - 1)(x - 3)(x + 1)$ is already in factored form. As the factors are unique, there are **three distinct roots** and so the curve **cuts the x -axis** at $x = 1$, $x = -1$ and $x = 3$.

As the leading coefficient is positive the graph has the basic shape:



The y -intercept occurs when $x = 0$, i.e., $P(0) = (-1)(-3)(1) = 3$.

Note: Turning point does not occur at $(0,3)$.

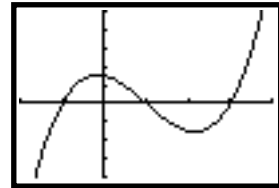
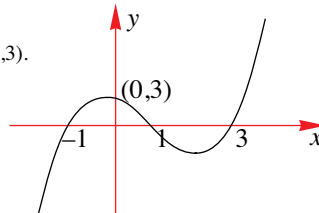

- (b) The polynomial $P(x) = (x - 1)^2(x + 3)$ is in factored form and has a repeated factor $(x - 1)^2$ and a unique factor $(x + 3)$. That is, it has a **double root** at $x = 1$ and a **single root** at $x = -3$. This means the curve will have a **turning point** on the x -axis at $x = 1$ and will **cut the x -axis** at $x = -3$.

As the leading coefficient is positive the graph has the basic shape:



The y -intercept occurs when $x = 0$, i.e., $P(0) = (-1)^2(3) = 3$.

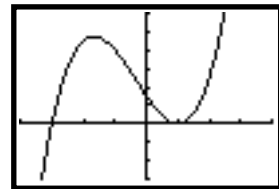
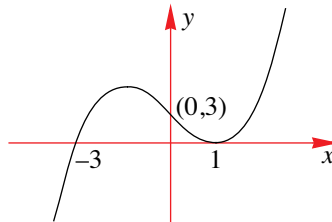

- (c) The polynomial $P(x) = (2 - x)^3$ is in factored form with repeated factor $(2 - x)^3$. This means that there is a **treble root** at $x = 2$ and so, there is a **stationary point of inflection** on the x -axis at $x = 2$.

As the leading coefficient is negative the graph has the basic shape:



The y -intercept occurs when $x = 0$, i.e., $P(0) = (2)^3 = 8$.

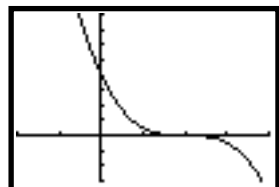
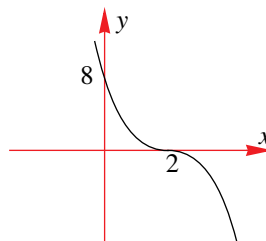

Note: We leave the general discussion of the cubic polynomial function $f(x) = a(x - k)^3 + h$ to Chapter 5, except to state that this curve would look exactly like $f(x) = ax^3$ but with its stationary point of inflection now located at (k, h) .

EXAMPLE 3.20

- Sketch the graph of
- (a) $P(x) = (2x - 1)(x + 1)^2(x - 2)$
 - (b) $P(x) = (1 - x)(x + 1)^3$
 - (c) $P(x) = x(x + 2)^3(x - 1)$.

S
o
l
u
t
i
o
n

(a) We have **single roots** at $x = \frac{1}{2}$ and $x = 2$ and a **double root** at $x = -1$. This means that the curve will **cut the x -axis** at $x = 0.5$ and $x = 2$ but will have a **turning point** at $(-1, 0)$. The y -intercept is given by $P(0) = (-1)(1)^2(-2) = 2$.

We start by filling in the information on a set of axes and then sort of 'join the dots':

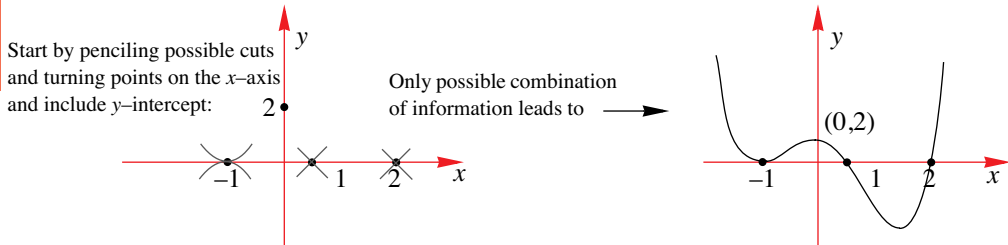

(b) We have a **single root** at $x = 1$ and a **treble root** at $x = -1$. This means that the curve will **cut the x -axis** at $x = -1$ and will have a **stationary point of inflection** at $(-1, 0)$. The y -intercept is given by $P(0) = (1)(1)^3 = 1$.

We start by filling in the information on a set of axes and then sort of 'join the dots':

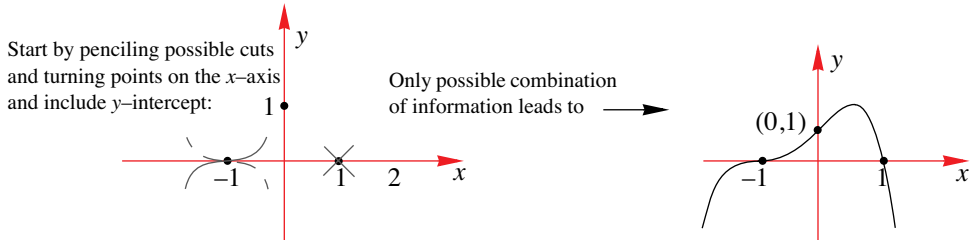

(c) We have **single roots** at $x = 0$ and $x = 1$ and a **treble root** at $x = -2$. This means that the curve will **cut the x -axis** at $x = 0$ and $x = 1$ and will have a **stationary point of inflection** at $(-2, 0)$.

The y -intercept is given by $P(0) = (0)(2)^3(-1) = 0$.

We start by filling in the information on a set of axes and then sort of 'join the dots':

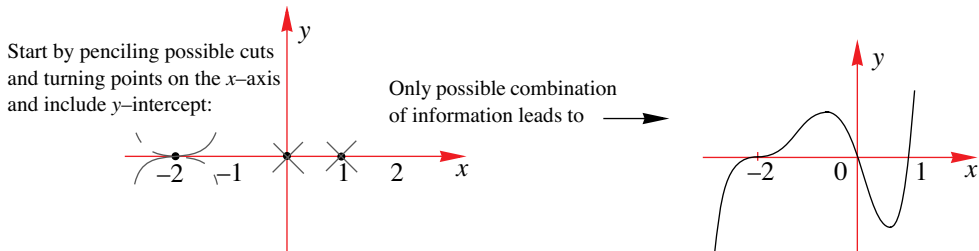

MATHEMATICS – Higher Level (Core)

So far we have looked at sketching graphs of polynomials whose equations have been in factored form. So what happens when a polynomial function isn't in factored form? Well, in this case we first factorise the polynomial (if possible) and use the same process as we have used so far. We factorise the polynomial either by 'observation' or by making use of the factor theorem.

EXAMPLE 3.21

Sketch the graph of $f(x) = x^3 - 3x^2 - x + 3$.

S
O
L
I
T
I
O
N

By observation, we have:
$$\begin{aligned}x^3 - 3x^2 - x + 3 &= x^2(x - 3) - (x - 3) \\ &= (x^2 - 1)(x - 3) \\ &= (x + 1)(x - 1)(x - 3)\end{aligned}$$

That is, $f(x) = (x + 1)(x - 1)(x - 3)$.

This is in fact the same function as that in Example 3.19 (a) and so we have:

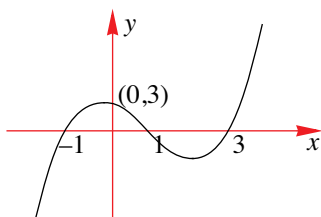

As always, we also have at our disposal the graphics calculator!

We now look at obtaining the equation of a polynomial from a given set of information. If a graph of a polynomial has sufficient information, then it is possible to determine the unique polynomial satisfying all the given information.

EXAMPLE 3.21

Determine the equation of the following cubic graphs

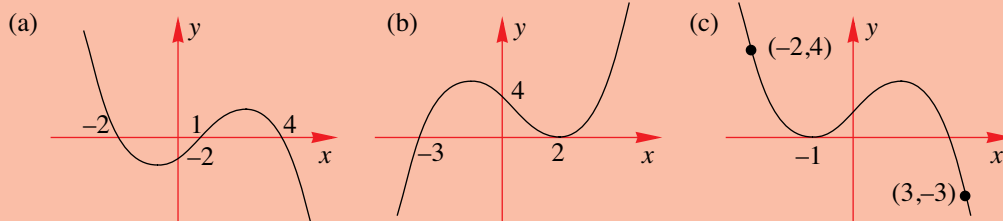

S
O
L
I
T
I
O
N

(a) In this instance we have the curve cutting the x -axis at three distinct points, $x = -2$, $x = 1$ and $x = 4$, meaning that the function will have three distinct factors, namely, $x + 2$, $x - 1$ and $x - 4$.

Therefore, we can write down the equation $f(x) = a(x + 2)(x - 1)(x - 4)$, where a needs to be determined.

Using the point $(0, -2)$ we have $f(0) = a(0 + 2)(0 - 1)(0 - 4) = -2 \therefore 8a = -2 \Leftrightarrow a = -\frac{1}{4}$.

Therefore, $f(x) = -\frac{1}{4}(x + 2)(x - 1)(x - 4)$.

(b) In this instance we have the curve cutting the x -axis at one point, $x = -3$, and having a

turning point at $x = 2$. Meaning that the function will have a single linear factor, $x + 3$, and a repeated factor $(x - 2)^2$.

Therefore, we can write down the equation $f(x) = a(x + 3)(x - 2)^2$, where a needs to be determined.

Using the point $(0, 4)$ we have $f(0) = a(0 + 3)(0 - 2)^2 = 4 \therefore 12a = 4 \Leftrightarrow a = \frac{1}{3}$.

Therefore, $f(x) = \frac{1}{3}(x + 3)(x - 2)^2$.

(c) The only obvious information is that there is a turning point at $x = -1$ and so the polynomial will have a repeated factor $(x + 1)^2$.

Therefore the polynomial will take on the form $f(x) = (ax + b)(x + 1)^2$.

Then, to determine the values of a and b we use the coordinates $(-2, 4)$ and $(3, -3)$.

At $(-2, 4)$: $4 = (-2a + b)(-2 + 1)^2 \Leftrightarrow 4 = -2a + b$ — (1)

At $(3, -3)$: $-3 = (3a + b)(3 + 1)^2 \Leftrightarrow -3 = 48a + 16b$ — (2)

Solving for a and b we have:

From (1) $b = 4 + 2a$ and substituting into (2) we have $-3 = 48a + 16(4 + 2a) \therefore a = -\frac{67}{80}$

Substituting into $b = 4 + 2a$ we have $b = 4 + 2\left(-\frac{67}{80}\right) = \frac{93}{40}$.

Therefore, $f(x) = \left(-\frac{67}{80}x + \frac{93}{40}\right)(x + 1)^2 = \frac{1}{80}(186 - 67x)(x + 1)^2$.

EXERCISES 3.6

1. Sketch the graphs of the following polynomials

(a) $P(x) = x(x - 2)(x + 2)$ (b) $P(x) = (x - 1)(x - 3)(x + 2)$

(c) $T(x) = (2x - 1)(x - 2)(x + 1)$ (d) $P(x) = \left(\frac{x}{3} - 1\right)(x + 3)(x - 1)$

(e) $P(x) = (x - 2)(3 - x)(3x + 1)$ (f) $T(x) = (1 - 3x)(2 - x)(2x + 1)$

(g) $P(x) = -x^2(x - 4)$ (h) $P(x) = (1 - 4x^2)(2x - 1)$

(i) $T(x) = (x - 1)(x - 3)^2$ (j) $T(x) = \left(1 - \frac{x}{2}\right)^2(x + 2)$

(k) $P(x) = x^2(x + 1)(2x - 3)$ (l) $P(x) = 4x^2(x - 2)^2$

(m) $P(x) = \frac{1}{2}(x - 3)(x + 1)(x - 2)^2$ (n) $T(x) = -(x - 2)(x + 2)^3$

(o) $P(x) = (x^2 - 9)(3 - x)^2$ (p) $T(x) = -2x(x - 1)(x + 3)(x + 1)$

(q) $P(x) = x^4 + 2x^3 - 3x^2$ (r) $T(x) = \frac{1}{4}(4 - x)(x + 2)^3$

(s) $T(x) = -x^3(x^2 - 4)$ (t) $T(x) = (2x - 1)\left(\frac{x}{2} - 1\right)(x - 1)(1 - x)$

MATHEMATICS – Higher Level (Core)

2. Sketch the graph of the following polynomials

(a) $P(x) = x^3 - 4x^2 - x + 4$

(b) $P(x) = x^3 - 6x^2 + 8x$

(c) $P(x) = 6x^3 + 19x^2 + x - 6$

(d) $P(x) = -x^3 + 12x + 16$

(e) $P(x) = x^4 - 5x^2 + 4$

(f) $P(x) = 3x^3 - 6x^2 + 6x - 12$

(g) $P(x) = -2x^4 + 3x^3 + 3x^2 - 2x$

(h) $P(x) = 2x^4 - 3x^3 - 9x^2 - x + 3$

(i) $T(x) = x^4 - 5x^3 + 6x^2 + 4x - 8$

(j) $T(x) = x^4 + 2x^3 - 3x^2 - 4x + 4$

3. Sketch the graph of

(a) $P(x) = x^3 - kx$ where i. $k = b^2$ ii. $k = -b^2$.

(b) $P(x) = x^3 - kx^2$ where i. $k = b^2$ ii. $k = -b^2$.

4. Determine the equations of the following cubic functions

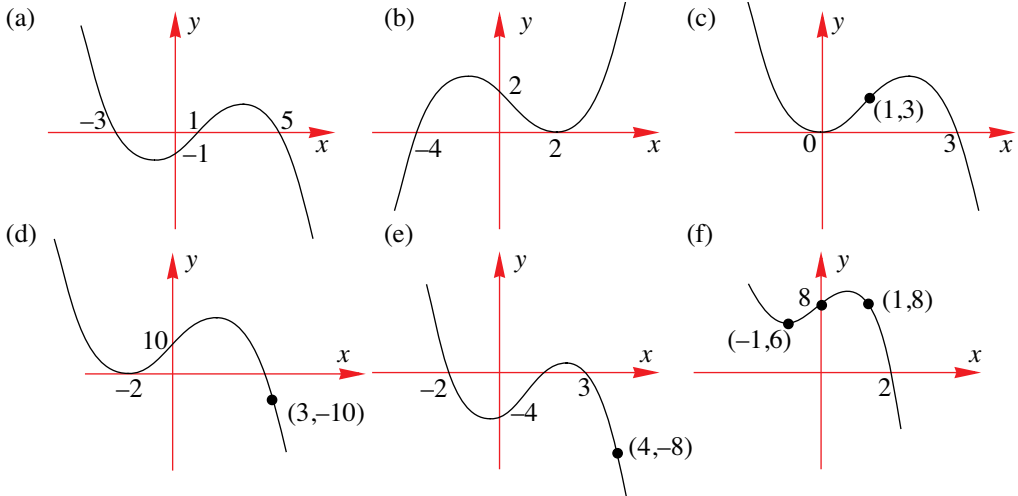

5. Determine the equation of the following functions

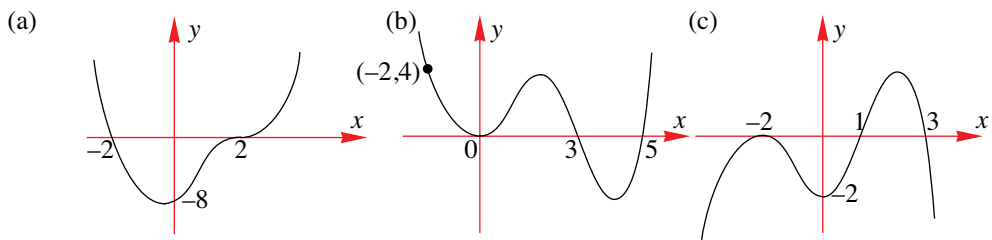

6. Sketch a graph of $f(x) = (x - b)(ax^2 + bx + c)$ if $b > 0$ and

(a) $b^2 - 4ac = 0, a > 0, c > 0$

(b) $b^2 - 4ac > 0, a > 0, c > 0$

(c) $b^2 - 4ac < 0, a > 0, c > 0$

7. (a) On the same set of axes sketch the graphs of $f(x) = (x - a)^3$ and

$g(x) = (x - a)^2$. Find $\{(x, y) : f(x) = g(x)\}$.

(b) Hence find $\{x : (x - a)^3 > (x - a)^2\}$.

4.1 THE BINOMIAL THEOREM

4.1.1 THE BINOMIAL THEOREM

Bracketed expressions such as $(2x - 3)^7$ are called ‘binomial’ because there are two terms in the bracket (the prefix bi- means two). Such expressions can be expanded using the distributive law. In a simple case such as $(a + b)^2$ the distributive law gives:

$$\begin{aligned}(a + b)^2 &= (a + b)(a + b) \\ &= a^2 + ab + ba + b^2 \\ &= a^2 + 2ab + b^2\end{aligned}$$

The distributive law states that each term in the first bracket must be multiplied by each term in the second bracket.

The next most complicated binomial can be evaluated using the previous result:

$$\begin{aligned}(a + b)^3 &= (a + b)(a + b)^2 \\ &= (a + b)(a^2 + 2ab + b^2) \\ &= a^3 + 2a^2b + ab^2 + a^2b + 2ab^2 + b^3 \\ &= a^3 + 3a^2b + 3ab^2 + b^3\end{aligned}$$

Similarly, the fourth power of this simple binomial expression can be expanded as:

$$\begin{aligned}(a + b)^4 &= (a + b)(a + b)^3 \\ &= (a + b)(a^3 + 3a^2b + 3ab^2 + b^3) \\ &= a^4 + 3a^3b + 3a^2b^2 + ab^3 + a^3b + 3a^2b^2 + 3ab^3 + b^4 \\ &= a^4 + 4a^3b + 6a^2b^2 + 4ab^3 + b^4\end{aligned}$$

The calculations are already fairly complex and it is worth looking at these results for the underlying pattern. There are three main features to the pattern. Looking at the fourth power example above, these patterns are:

1. The powers of a .

These start at 4 and decrease: a^4, a^3, a^2, a^1, a^0 . Remember that $a^0 = 1$

2. The powers of b .

These start at 0 and increase: b^0, b^1, b^2, b^3, b^4 . Putting these two patterns together gives the final pattern of terms in which the sum of the indices is always 4:

$$\dots a^{\overset{4}{4}} + \dots a^{\overset{3+1=4}{3}}b^{\underset{1}{1}} + \dots a^{\overset{2+2=4}{2}}b^{\underset{2}{2}} + \dots a^{\overset{1+3=4}{1}}b^{\underset{3}{3}} + \dots b^{\underset{4}{4}}$$

3. The coefficients complete the pattern.

These coefficients arise because there is more than one way of producing most of the terms. Following the pattern begun above, produces a triangular pattern of

MATHEMATICS – Higher Level (Core)

coefficients known as Pascal’s Triangle. Blaise Pascal (1623-1662) developed early probability theory but is lucky to have this triangle named after him as it had been studied by Chinese mathematicians long before he was born.

So, if we continue our expansions (up to and including the sixth power) we have the following:

$$\begin{aligned}
 (x + a)^0 &= && 1 \\
 (x + a)^1 &= && 1x + 1a \\
 (x + a)^2 &= && 1x^2 + 2ax + 1a^2 \\
 (x + a)^3 &= && 1x^3 + 3x^2a + 3xa^2 + 1a^3 \\
 (x + a)^4 &= && 1x^4 + 4x^3a + 6x^2a^2 + 4xa^3 + 1a^4 \\
 (x + a)^5 &= && \mathbf{1}x^5 + \mathbf{5}x^4a + \mathbf{10}x^3a^2 + \mathbf{10}x^2a^3 + \mathbf{5}xa^4 + \mathbf{1}a^5 \\
 (x + a)^6 &= && 1x^6 + 6x^5a + 15x^4a^2 + 20x^3a^3 + 15x^2a^4 + 6xa^5 + 1a^6 \\
 : & & & : \\
 \text{etc.} & \text{ etc.} & & \text{etc.}
 \end{aligned}$$

Now consider only the coefficients for the above expansions. Writing down these coefficients we reproduce Pascal’s triangle:

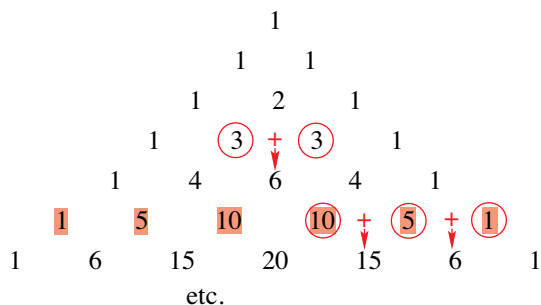

The numbers in the body of the triangle are found by adding the two numbers immediately above and to either side.

An alternative to using Pascal’s Triangle to find the coefficients is to use combinatorial numbers. If expanding $(a + b)^5$ the set of coefficients are:

$$\binom{5}{0} = 1, \binom{5}{1} = 5, \binom{5}{2} = 10, \binom{5}{3} = 10, \binom{5}{4} = 5, \binom{5}{5} = 1$$

which are the same as those given by Pascal’s Triangle.

Most calculators can do this.

The TI-83 uses the **MATH** main menu command followed by the **PRB** (probability) sub-menu.

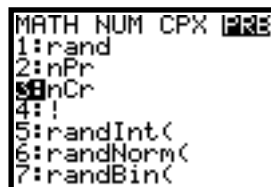

To calculate a combinatorial number such as $\binom{5}{2} = {}^5C_2$, return to the ready mode and enter 5. Select **nCr** as previously described, press 2 and press **ENTER**.

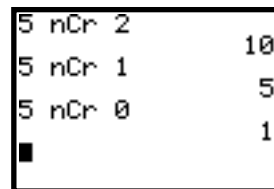

In a case such as this in which it may be necessary to calculate a sequence of related combinatorial numbers, it is much quicker to use the replay and edit feature of the calculator (2nd **ENTRY**).

Or, we can represent **nCr** as a function. For example, we can set **Y = 5nCrX**, meaning that we now have a function of $x, y = \binom{5}{x}, x = 0, 1, \dots, 5$.

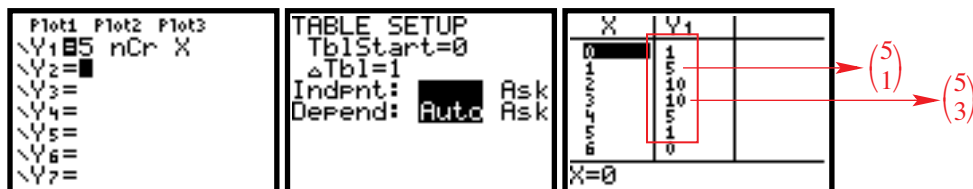

EXAMPLE 4.1

Expand $(x + y)^6$

S
O
L
I
T
I
O
N

(a) **Step 1:** Making use of Pascal's triangle we first determine the required coefficients:

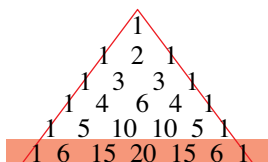

Step 2: Write down each term:

$$x^6y^0 \quad x^5y^1 \quad x^4y^2 \quad x^3y^3 \quad x^2y^4 \quad x^1y^5 \quad x^0y^6$$

Finally, combine the two steps:

$$x^6y^0 + 6x^5y^1 + 15x^4y^2 + 20x^3y^3 + 15x^2y^4 + 6x^1y^5 + x^0y^6$$

Obviously, we can also combine the two steps into one:

$$\begin{aligned} (x + y)^6 &= {}^6C_0x^6y^0 + {}^6C_1x^5y^1 + {}^6C_2x^4y^2 + {}^6C_3x^3y^3 + {}^6C_4x^2y^4 + {}^6C_5x^1y^5 + {}^6C_6x^0y^6 \\ &= x^6y^0 + 6x^5y^1 + 15x^4y^2 + 20x^3y^3 + 15x^2y^4 + 6x^1y^5 + x^0y^6 \end{aligned}$$

And, with practice, you should be able to expand such expressions as we have just done.

What happens if we have the difference of two terms rather than the sum? For example, what about expanding $(x - a)^5$? Well the process is the same except that this time we rewrite $(x - a)^5$ as follows:

$$(x - a)^5 = (x + (-a))^5$$

So, how do we proceed? Essentially in exactly the same way.

MATHEMATICS – Higher Level (Core)

Step 1: Making use of Pascal's triangle we first determine the required coefficients:

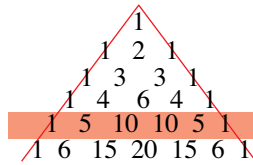

Notice that Pascal's triangle does not change due to the change in sign and so the coefficients remain the same whether it is a sum or difference.

Step 2: Write down each term:

$$\begin{array}{cccccc} (x)^5(a)^0 & (x)^4(-a) & (x)^3(-a)^2 & (x)^2(-a)^3 & (x)^1(-a)^4 & (x)^0(-a)^5 \\ \text{i.e.,} & x^5 & -x^4a & x^3a^2 & -x^2a^3 & xa^4 & -a^5 \end{array}$$

Combining the coefficients and the terms we have:

$$(x - a)^5 = x^5 - 5x^4a + 10x^3a^2 - 10x^2a^3 + 5xa^4 - a^5$$

So basically the only difference is in the alternating negative sign.

EXAMPLE 4.2

Expand

(a) $(4x - 3)^3$

(b) $\left(2x - \frac{2}{x}\right)^3$

Solution

(a) **Step 1:** Making use of Pascal's triangle we first determine the required coefficients:

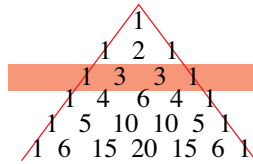

Step 2: Write down each term:

$$\begin{array}{cccc} (4x)^3 & (4x)^2(-3) & (4x)(-3)^2 & (-3)^3 \\ 64x^3 & -48x^2 & 36x & -27 \end{array}$$

Combining steps one and two we have:

$$\begin{aligned} (4x - 3)^3 &= 1 \times 64x^3 + 3 \times -48x^2 + 3 \times 36x + 1 \times -27 \\ &= 64x^3 - 144x^2 + 108x - 27 \end{aligned}$$

(b) As with (a), the term pattern must be built on $(2x)$ and $-\frac{2}{x}$:

$$\begin{aligned} \left(2x - \frac{2}{x}\right)^3 &= 1 \times (2x)^3 \left(-\frac{2}{x}\right)^0 + 3 \times (2x)^2 \left(-\frac{2}{x}\right)^1 + 3 \times (2x)^1 \left(-\frac{2}{x}\right)^2 + 1 \times (2x)^0 \left(-\frac{2}{x}\right)^3 \\ &= 8x^3 - 24x + \frac{24}{x} - \frac{8}{x^3} \end{aligned}$$

What about an expansion of the form $(x + 2y + 1)^4$? How do we deal with this situation? Again, we use our two steps, however, as we did when we introduced a difference rather than a sum, we need to rearrange our expression slightly. We do this by writing $(x + 2y + 1)^4$ as $(x + (2y + 1))^4$

and treating the sum as one made up of ‘ x ’ and ‘ $(2y + 1)$ ’. So, we have:

Step 1: Making use of Pascal’s triangle we first determine the required coefficients:

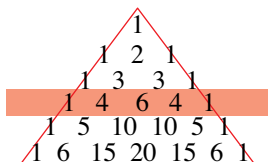

Step 2: Write down each term:

$$(x)^4 \quad (x)^3(2y + 1) \quad (x)^2(2y + 1)^2 \quad (x)(2y + 1)^3 \quad (2y + 1)^4$$

Now, the first two terms are easy enough

$$x^4 \quad 2x^3y + x^3$$

In fact, the third term is not all that bad either:

$$x^2(4y^2 + 4y + 1) = 4x^2y^2 + 4x^2y + x^2$$

The fourth term, well we need to use Pascal’s triangle again, which will lead to:

$$x(8y^3 + 12y^2 + 6y + 1) = 8xy^3 + 12xy^2 + 6xy + x$$

Similarly for the fifth term:

$$(2y + 1)^4 = 16y^4 + 32y^3 + 24y^2 + 8y + 1$$

Then, combining the coefficients with step 2 we have:

$$\begin{aligned}
 &1 \times x^4 + 4 \times [2x^3y + x^3] + 6 \times [4x^2y^2 + 4x^2y + x^2] + 4 \times [8xy^3 + 12xy^2 + 6xy + x] \\
 &+ 1 \times [16y^4 + 32y^3 + 24y^2 + 8y + 1]
 \end{aligned}$$

Which still needs to be expanded and then (hopefully) simplified. However, we stop here and leave the final simplification to you – if you feel up to it. The purpose was more to do with how to deal with an expansion that involves the sum of three terms instead of two. Of course, we can then extend this to an expansion involving the sum of four terms and so on.

EXERCISES 4.1.1

1. Expand the following binomial expressions:

- | | | |
|--|--|---------------------------------------|
| (a) $(b + c)^2$ | (b) $(a + g)^3$ | (c) $(1 + y)^3$ |
| (d) $(2 + x)^4$ | (e) $(2 + 2x)^3$ | (f) $(2x - 4)^3$ |
| (g) $\left(2 + \frac{x}{7}\right)^4$ | (h) $(2x - 5)^3$ | (i) $(3x - 4)^3$ |
| (j) $(3x - 9)^3$ | (k) $(2x + 6)^3$ | (l) $(b + 3d)^3$ |
| (m) $(3x + 2y)^4$ | (n) $(x + 3y)^5$ | (o) $\left(2p + \frac{5}{p}\right)^3$ |
| (p) $\left(x^2 - \frac{2}{x}\right)^4$ | (q) $\left(q + \frac{2}{p^3}\right)^5$ | (r) $\left(x + \frac{1}{x}\right)^3$ |

4.1.2 THE GENERAL TERM

We have already seen the relationship between Pascal’s triangle and its combinatorial equivalent. From this relationship we were able to produce the general expansion for $(x + a)^n$. That is,

$$(x + a)^n = \binom{n}{0}x^n + \binom{n}{1}x^{n-1}a + \binom{n}{2}x^{n-2}a^2 + \dots + \binom{n}{r}x^{n-r}a^r + \dots + a^n$$

- Where the **first** term, $t_1 = \binom{n}{0}x^n$
- the **second** term, $t_2 = \binom{n}{1}x^{n-1}a$
- the **third** term, $t_3 = \binom{n}{2}x^{n-2}a^2$
- ⋮
- ⋮
- the **r**th term, $t_r = \binom{n}{r-1}x^{n-(r-1)}a^{r-1}$
- and the **(r + 1)**th term, $t_{r+1} = \binom{n}{r}x^{n-r}a^r$

The $(r + 1)$ th term is also known as the **general term**. That is

$$t_{r+1} = \binom{n}{r}x^{n-r}a^r$$

It is common in examinations for questions to only ask for a part of an expansion. This is because the previous examples are time consuming to complete.

EXAMPLE 4.3

Find the 5th term in the expansion $\left(x + \frac{2}{x}\right)^{10}$, when expanded in descending powers of x .

S
o
l
u
t
i
o
n

The fifth term is given by t_5 . Using the general term, this means that $r + 1 = 5 \Leftrightarrow r = 4$. For this expansion we have that $n = 10$, therefore,

$$\begin{aligned} t_5 &= \binom{10}{4}(x)^{10-4}\left(\frac{2}{x}\right)^4 = 210 \times x^6 \times \frac{16}{x^4} \\ &= 3360x^2 \end{aligned}$$

Therefore the fifth term is $t_5 = 3360x^2$.

EXAMPLE 4.4

Find the coefficient of x^{12} in the expansion $(x^2 - 2)^8$.

S
o
l
u
t
i
o
n

The general term for this expansion is given by $t_{r+1} = \binom{8}{r}(x^2)^{8-r}(-2)^r$

$$= \binom{8}{r}x^{16-2r}(-2)^r$$

Seeing as we want the term involving x^{12} we equate the power of x in the general term to 12:
So, $16 - 2r = 12 \Leftrightarrow 2r = 4 \Leftrightarrow r = 2$.

Then, $t_3 = \binom{8}{2}x^{16-4}(-2)^2 = 2(8) \times x^{12} \times 4 = 112x^{12}$. So, the coefficient of x^{12} is in fact 112.

EXAMPLE 4.5

Find the term independent of x in the expansion $\left(2x - \frac{1}{x^2}\right)^6$.

S
o
l
u
t
i
o
n

In this case we want the term independent of x , that is, the term that involves x^0 .

Again, we first find an expression for the general term, $t_{r+1} = \binom{6}{r}(2x)^{6-r}\left(-\frac{1}{x^2}\right)^r$

$$= \binom{6}{r}(2)^{6-r}(x)^{6-r}(-1)^r(x^{-2})^r$$

$$= \binom{6}{r}2^{6-r}(-1)^rx^{6-r-2r}$$

$$= \binom{6}{r}2^{6-r}(-1)^rx^{6-3r}$$

Notice how we had to separate the constants and the x term.

Next, we equate the power of x in the expansion to 0: $6 - 3r = 0 \Leftrightarrow r = 2$.

We therefore want $t_3 = \binom{6}{2}2^{6-2}(-1)^2x^{6-6} = 15 \times 16 \times 1 \times x^0 = 240$.

So, the term independent of x is 240.

EXAMPLE 4.6

Write the expansion of $(1 + x)^6$

- i. Use the first three terms of the series to approximate 1.01^6
- ii. Find the absolute, relative and percentage errors in making this approximation.

S
o
l
u
t
i
o
n

$$(1 + x)^6 = 1 + 6x + 15x^2 + 20x^3 + 15x^4 + 6x^5 + x^6$$

- i. 1.01^6 can be approximated using the expansion of $(1 + x)^6$ and an x value of 0.01
 $1.01^6 \approx 1 + 6 \times 0.01 + 15 \times 0.01^2 = 1.0615$ using the first three terms of the series.
- ii. The correct answer can be found using the power key of a calculator and is

MATHEMATICS – Higher Level (Core)

1.061520150601. It is probable that most calculators will not be able to display the 12 decimal places of the full answer. An answer such as 1.0615201506 is sufficient for the remaining part of this problem

$$\text{The absolute error} = |1.0615 - 1.0615201| \approx 2.015 \times 10^{-5}$$

$$\text{The relative error} \approx \frac{2.015 \times 10^{-5}}{1.01^6} \approx 1.898 \times 10^{-5}$$

$$\text{The percentage error} \approx 1.898 \times 10^{-5} \approx 1.898 \times 10^{-3} \%$$

EXERCISES 4.1.2

1. Find the terms indicated in the expansions of the following expressions:

	Expression	Term
(a)	$(x + 4)^5$	x^3
(b)	$(x + y)^7$	x^5y^2
(c)	$(2x - 1)^8$	x^3
(d)	$(3x - 2)^5$	x^4
(e)	$(2 - 3p^2)^4$	p^4
(f)	$(2p - 3q)^7$	p^2q^5
(g)	$\left(3p - \frac{2}{p}\right)^7$	p

2. Find the coefficients of the terms indicated in the expansions of the following expressions:

	Expression	Term
(a)	$(2x - 5)^8$	x^3
(b)	$(5x - 2y)^6$	x^2y^4
(c)	$(x + 3)^6$	x^3
(d)	$(2p - 3q)^5$	p^4q
(e)	$\left(2x - \frac{3}{p}\right)^8$	$\frac{x^2}{p^6}$
(f)	$\left(q + \frac{2}{p^3}\right)^5$	$\frac{q^3}{p^6}$

3. Use the first three terms in the expansion of $(1 + x)^4$ to find an approximate value for 1.01^4 . Find the percentage error in using this approximation.

4. (i) Write the expansion of $(5 + 2x)^6$.
(ii) Use the first three terms of the expansion to approximate 5.2^6 .

- (iii) Find the absolute error in this approximation.
 (iv) Find the percentage error in this approximation.
- 5.** Find the coefficient of x^{-3} in the expansion of $(x-1)^3\left(\frac{1}{x}+x\right)^6$.
- 6.** Find the constant term in the expansion of $\left(x-\frac{1}{2x}\right)^{10}$.
- 7.** Find the constant term in the expansion of $\left(3x-\frac{1}{6x}\right)^{12}$.
- 8.** Find the term independent of x in the expansion of $(2-x)^3\left(\frac{1}{3x}-x\right)^6$.
- 9.** Find the term independent of x in the expansion of $\left(2x-\frac{1}{x}\right)^6\left(\frac{1}{2x}+x\right)^6$.
- 10.** In the expansion of $\left(x-\frac{a}{x}\right)^5\left(x+\frac{a}{x}\right)^5$, where a is a non-zero constant, the coefficient of the term in x^{-2} is '-9' times the coefficient in x^2 . Find the value of the constant a .
- 11.** If the coefficient of the x^2 in the expansion of $(1-3x)^n$ is 90, find n .
- 12.** Three consecutive coefficients in the expansion of $(1+x)^n$ are in the ratio 6 : 14 : 21. Find the value of n .
- 13.** Find the independent term in the following expansions
 (a) $\left(y+\frac{1}{y}\right)^3\left(y-\frac{1}{y}\right)^5$ (b) $\left(2x+1-\frac{1}{2x^2}\right)^6$
- 14.** In the expansion of $(1+ax)^n$ the first term is 1, the second term is $24x$ and the third term is $252x^2$. Find the values of a and n .
- 15.** In the expansion of $(x+a)^3(x-b)^6$ the coefficient of x^7 is -9 and there is no x^8 term. Find a and b .
- 16.** By considering the expansion of $(1+x)^{m+n}$, prove that:
 (a) ${}^{m+n}C_1 = {}^mC_1 + {}^nC_1$
 (b) ${}^{m+n}C_2 = {}^mC_2 + {}^mC_1 {}^nC_1 + {}^nC_2$

4.2 PROOF

Note: This proof by induction is outside the scope of the syllabus.

A formal statement of the binomial expansion is:

$$(a + b)^k = {}^nC_0 a^k b^0 + {}^nC_1 a^{k-1} b^1 + \dots + {}^nC_r a^{k-r} b^r + \dots + {}^nC_k a^0 b^k = \sum_{r=0}^n {}^nC_r a^{n-r} b^r$$

The binomial theorem for positive integral index may be proved using mathematical induction.

A preliminary result from combinatorics is required, namely ${}^nC_r + {}^nC_{r-1} = {}^{n+1}C_r$. We leave its proof as an exercise. We can now move on to the main induction proof:

(i) Check the case $k = 1$: $(a + b)^1 = {}^1C_0 a^1 + {}^1C_1 b^1 = a + b$, which is true.

(ii) Assume the theorem is true for $n = k$:

$$(a + b)^k = {}^kC_0 a^k b^0 + {}^kC_1 a^k b^1 + \dots + {}^kC_r a^{k-r} b^r + \dots + {}^kC_k a^0 b^k$$

(iii) Look at the $n = k + 1$. This involves multiplying each term in the expansion from (ii) first by a and then by b . To see what happens to the general term, it is a good idea to look at two consecutive terms in the middle of the expansion from (ii):

$$(a + b)^k = {}^kC_0 a^k b^0 + \dots + {}^kC_{r-1} a^{k-r+1} b^{r-1} + {}^kC_r a^{k-r} b^r + \dots + {}^kC_k a^0 b^k$$

When this expansion has been multiplied by a , the result is:

$${}^kC_0 a^{k+1} b^0 + \dots + {}^kC_{r-1} a^{k-r+2} b^{r-1} + {}^kC_r a^{k-r+1} b^r + \dots + {}^kC_k a^1 b^k$$

and when it is multiplied by b , the result is:

$${}^kC_0 a^k b^1 + \dots + {}^kC_{r-1} a^{k-r+1} b^r + {}^kC_r a^{k-r} b^{r+1} + \dots + {}^kC_k a^0 b^{k+1}$$

The expansion of $(a + b)^{k+1}$ begins with ${}^kC_0 a^{k+1} b^0 = a^{k+1} b^0 = a^{k+1}$, which is correct. The expansion ends with ${}^kC_k a^0 b^{k+1} = a^0 b^{k+1} = b^{k+1}$, which is also correct.

It now remains to prove that the general term in the middle of the expansion is also correct.

Lining up like terms from the two parts of the expansion gives:

$$\begin{aligned} & {}^kC_{r-1} a^{k-r+2} b^{r-1} + {}^kC_r a^{k-r+1} b^r \\ & \qquad \qquad \qquad {}^kC_{r-1} a^{k-r+1} b^{r-1} + {}^kC_r a^{k-r} b^r + 1 \end{aligned}$$

$$\begin{aligned} \text{The general term is: } & {}^kC_r a^{k-r+1} b^r + {}^kC_{r-1} a^{k-r+1} b^r = [{}^kC_r + {}^kC_{r-1}](a^{k-r+1} b^r) \\ & = {}^{k+1}C_r a^{k-r+1} b^r \end{aligned}$$

[Using the combinatorial result given at the start of this section].

(iv) We can conclude that the binomial theorem gives the correct expansion for $n = 1$ from part (i). Part (iii) indicates that the theorem gives the correct expansion for an index of 2, 3 etc. Hence the theorem holds for all positive integral indices.

5.1 RELATIONS

5.1.1 RELATIONS

Consider the relationship between the weight of five students and their ages as shown below.

We can represent this information as a **set of ordered pairs**. An age of 10 years would correspond to a weight of 31kg. An age of 16 years would correspond to a weight of 53kg and so on.

Age (years)	Weight (kg)
10	31
12	36
14	48
16	53
18	65

This type of information represents a **relation** between two sets of data. This information could then be represented as a set of ordered pairs,

$$\{(10, 31), (12, 36), (14, 48), (16, 53), (18, 65)\}$$

The **set of all first elements** of the ordered pair is called the **domain** of the relation and is referred to as the **independent variable**. The **set of all second elements** is called the **range** and is referred to as the **dependent variable**.

For the above example, the domain = {10, 12, 14, 16, 18}
and the range = {31, 36, 48, 53, 65}.

Notice that (10, 31) and (31,10) are not the same! This is because the ordered pair (10, 31) provides the correct relation between age and weight, i.e., at age 10 years the weight of the student is 31kg. On the other hand, the ordered pair (31,10) would be informing us that at age 31 years the weight of the student is 10kg!

Summary:

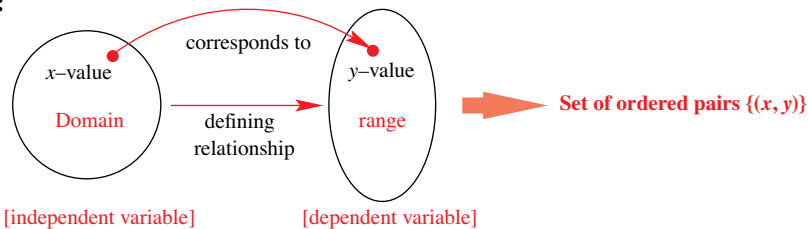

EXAMPLE 5.1

Determine the domain and range for each of the following relations:

- (a) $\{(0,0), (1,1), (2,4), (3,9), (4,16), (5,25)\}$.
- (b) $\{(-3,4), (-1,0), (2,-2), (-2,2)\}$.

S
o
l
u
t
i
o
n

- (a) The domain is the set of all first elements, i.e., {0, 1, 2, 3, 4, 5}.
The range is the set of all second elements, i.e., {0, 1, 4, 9, 16, 25}.
- (b) The domain is the set of all first elements, i.e., {-3, -1, 2, -2}.
The range is the set of all second elements, i.e., {4, 0, -2, 2}

MATHEMATICS – Higher Level (Core)

The letter ‘X’ is often used to denote the domain and the letter ‘Y’ to denote the range. For part (a) this means that we could write $X = \{0, 1, 2, 3, 4, 5\}$ and $Y = \{0, 1, 4, 9, 16, 25\}$ and for (b) we could write $X = \{-3, -1, 2, -2\}$ and $Y = \{4, 0, -2, 2\}$. This is a convention, nothing more.

Rather than giving a verbal description of how the independent variable and the dependent variable are related, it is much clearer to provide a **mathematical rule** that shows how the elements in the range relate to the elements in the domain.

EXAMPLE 5.2

A relation is defined by the rule $y = x + 2$, where $x \in \{0, 1, 2, 3, 4\}$.

- (a) Determine the range of this relation.
- (b) Express this relation as a set of ordered pairs.

Solution

- (a) The domain of this relation is given by the x -values, i.e., $\{0, 1, 2, 3, 4\}$. We can therefore substitute these values into the equation $y = x + 2$ and determine their corresponding y -values. This will provide the range of the relation.

Substituting we have, $x = 0 \Rightarrow y = 0 + 2 = 2$

$$x = 1 \Rightarrow y = 1 + 2 = 3$$

$$x = 2 \Rightarrow y = 2 + 2 = 4, \text{ and so on.}$$

This produces a set of y -values $\{2, 3, 4, 5, 6\}$ that defines the range.

- (b) The set of ordered pairs would be $\{(0, 2), (1, 3), (2, 4), (3, 5), (4, 6)\}$.

Notice that we can describe the set of ordered pairs more formally as:

$$\{(x, y) : y = x + 2, x \in \{0, 1, 2, 3, 4\}\}.$$

which is read as;

“The set of ordered pairs x and y , such that $y = x + 2$, where x is an element of the set of values $\{0, 1, 2, 3, 4\}$.”

The information in Example 5.2 can be displayed in different ways. Both those shown below are visual displays – they show the mappings in different ways:

Mapping diagram

The mapping diagram below displays which y -value corresponds to a given x -value.

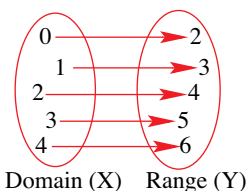

Cartesian Plane

The Cartesian plane is made up of a horizontal axis (independent variable, X) and a vertical axis (dependent variable, Y).

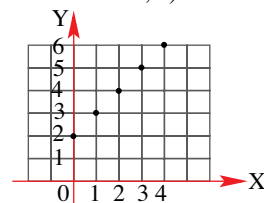

However it is often not easy to see the ‘pattern’ between the variables with this style of diagram. We plot the points on the grid, so that (3, 5) is 3 units to the right and 5 units up.

Notice that in the mapping diagram that uses the Cartesian plane, we have not joined the points together in a straight line. This is because the domain specifies that the only values of x that can be used must be from the set $\{0, 1, 2, 3, 4\}$, and so a value such as $x = 2.4$ cannot be used.

Both these visual representations are useful in displaying which values in the domain generate a given value in the range. However, the Cartesian plane more readily gives a quick overview of what the underlying relationship between the two variables is. It is very easy (and quick) to see that as the x -values increase, so too do the y -values. We can do this by simply looking at the points on the graph and observing the ‘trend’ without really concerning ourselves with what the actual values are.

We now provide a formal definition of the Cartesian plane and a relation.

5.1.2 THE CARTESIAN PLANE

The **Cartesian plane** is formed by constructing two real lines that intersect at a right-angle where the point of intersection of these two lines becomes the **origin**. The horizontal real line is usually referred to as the x -axis and the vertical real line is usually called the y -axis. This also implies that the plane has been divided into four **quadrants**. Each point on this plane is represented by an ordered pair (x, y) where x and y are real numbers and are the **coordinates** of the point.

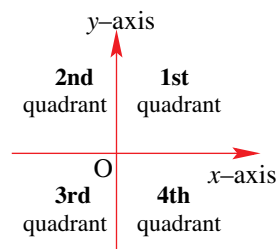

The set of all ordered pairs (x, y) , where $x \in X$ and $y \in Y$ can also be defined by making use of the Cartesian product, $X \times Y = \{(x, y) : x \in X, y \in Y\}$.

Relation

A **relation** is any subset of the Cartesian plane and can be represented by a set of ordered pairs $\{(x, y)\} \subseteq \mathbb{R} \times \mathbb{R}$, where the Cartesian product $\mathbb{R} \times \mathbb{R} (= \mathbb{R}^2)$ represents the region covered by the whole of the Cartesian plane.

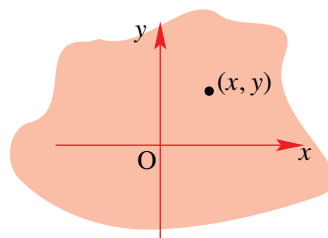

We now consider some further examples.

EXAMPLE 5.3

Determine the domain and range of the following relations

- (a) $y = 2 + x, x \geq 0$ (b) $y = 4 - x, -1 \leq x \leq 2$ (c) $y = 1 - x^2, x \geq 0$

Solution

Note: When finding the range of a relation, it is always a good idea to sketch its graph.

- (a) The equation $y = 2 + x, x \geq 0$ represents a straight line with the restriction that $x \geq 0$. So in this case, the domain is $[0, \infty)$ (or $[0, \infty[$).
From the graph, the range is given by $[2, \infty)$ (or $[2, \infty[$).

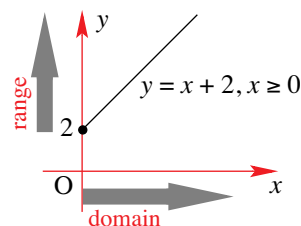

MATHEMATICS – Higher Level (Core)

- (b) The equation $y = 4 - x$, $-1 \leq x \leq 2$ represents a straight line with the restriction that $-1 \leq x \leq 2$. So in this case, the domain is $[-1, 2]$.
 when $x = -1$, $y = 5$ and when $x = 2$, $y = 2$
 From the graph, the range is given by $[2, 5]$.

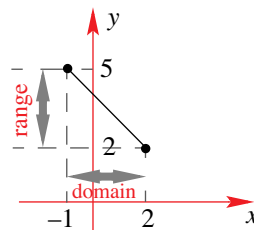

- (c) For this relation the domain is specified as $\{x : x \geq 0\}$ or simply $[0, \infty)$. So we can only sketch the graph of $y = 1 - x^2$, for these values of x . Using the graph we can see that the range is $\{y : y \leq 1\}$ or simply $(-\infty, 1]$.

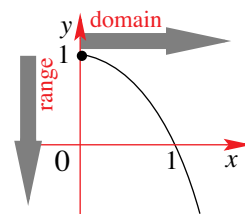

5.1.3 IMPLIED DOMAIN

So far we have looked at examples for which a domain has been specified. For example, if asked to find the range of the relation $y = 1 + x^2$, $x \geq 3$. Then, after sketching its graph, we would determine its range to be $[10, \infty)$. However, what if we only wanted to know the range of the relation $y = 1 + x^2$? In this case, because we have not been provided with any restriction on the x -values, we will need to assume that we can **use the largest possible set of x -values for which the relation is defined** – this domain is known as the **implied domain** (or **maximal domain**) – in this case that would be the real number set, \mathbb{R} . Then, after sketching the graph of $y = 1 + x^2$ for all real values of x we would have a range defined by $[1, \infty)$.

EXAMPLE 5.4

Determine the domain and range of the following relations

(a) $y = \sqrt{x-3}$

(b) $y = \frac{2}{\sqrt{x-3}}$

(c) $y = \frac{3}{2-x}$

S
o
l
u
t
i
o
n

- (a) Using the TI-83 to sketch the graph of $y = \sqrt{x-3}$ (i.e., the square root relation) we observe that its domain is $[3, \infty)$.

Now, let's take a closer look at why that is the case. Because we are dealing with an expression that involves a square root, then, the term 'inside' the square root must be greater than or equal to zero (as we cannot take the square root of a negative number).

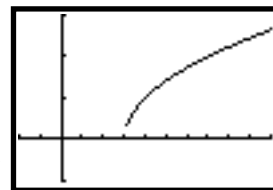

So, we must have that $x - 3 \geq 0 \Leftrightarrow x \geq 3$. Therefore, the implied domain is $\{x : x \geq 3\}$.
 From the graph, the range can be seen to be $[0, \infty)$.

It should be noted that the TI-83 uses the implied domain when graphing. Also realise that from the sketch, we could be misled into thinking that there is a 'gap' at the point $(3, 0)$. Be careful with this – use the graphics calculator as an aid, then, double check to make sure.

- (b) The equation $y = \frac{2}{\sqrt{x-3}}$ represents the reciprocal of a square root relation. As in (a), we must have that $x - 3 \geq 0 \Leftrightarrow x \geq 3$.

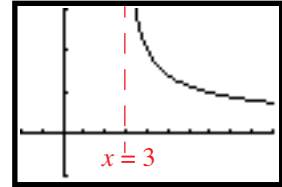

However, this time we have another restriction – we cannot divide by zero and so we cannot include $x = 3$ in our domain. So, at $x = 3$, we draw an **asymptote**.

We then have $x - 3 > 0 \Leftrightarrow x > 3$. This leads to a range of $(0, \infty)$ (or $]0, \infty[$).

- (c) The only restriction that can be readily seen for the relation $y = \frac{3}{2-x}$ is that we cannot divide by zero and so, we must have that $2 - x \neq 0$. That is, $x \neq 2$.

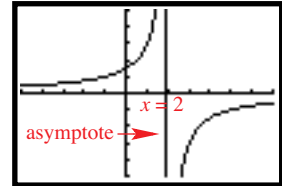

As it is a reciprocal relation, we have an asymptote at $x = 2$. So, the domain is given by $]-\infty, 2[\cup]2, \infty[$ or simply, $\mathbb{R} \setminus \{2\}$.

The range can then be seen to be $\mathbb{R} \setminus \{0\}$

5.1.4 TYPES OF RELATIONS

Relations fall into one of four categories. These are:

1. One to one relations [one x to one y]

For any one value of x , there will be only one corresponding value of y .

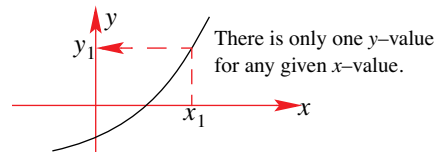

2. One to many relation [one x to many y]

There is at least one value of x for which there exists more than one corresponding value of y .

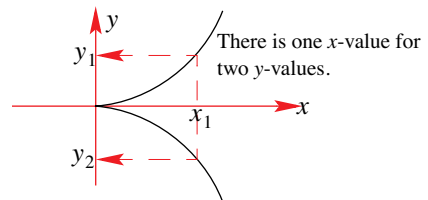

3. Many to one relation [many x to one y]

There are at least two different values of x that will correspond to only one value of y .

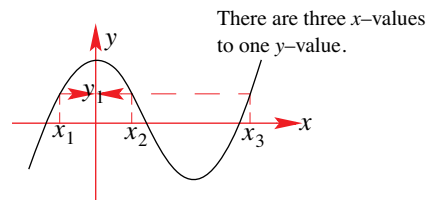

4. Many to many [many x to many y]

There are at least two different values of x that will correspond to at least two different values of y .

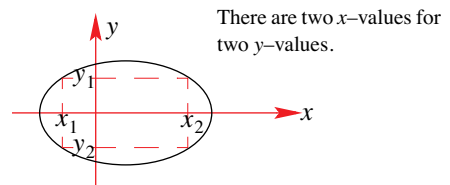

5.1.5 SKETCHING WITH THE GRAPHICS CALCULATOR

Why do graphs sometimes appear distorted on the graphics calculator display screen?

On most graphics calculators, the display screen is two thirds as high as it is wide. Because of this, when we graph a relation that describes a circle we obtain a diagram that is not a true geometric representation. To obtain a true geometric representation we need to use a window that

produces a square setting. This is done by using the fact that $\frac{Y_{max} - Y_{min}}{X_{max} - X_{min}} = \frac{2}{3}$.

For example, the window alongside shows such a setting:

$$\text{i.e., } \frac{Y_{max} - Y_{min}}{X_{max} - X_{min}} = \frac{4 - (-4)}{6 - (-6)} = \frac{8}{12} = \frac{2}{3}$$

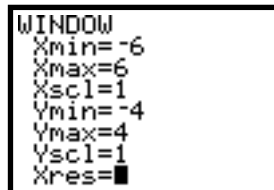

These settings enable us to obtain a true geometric representation of the circle with equation $x^2 + y^2 = 16$.

Re-arranging the equation to make y the subject, we have, $x^2 + y^2 = 16 \Rightarrow y = \pm\sqrt{16 - x^2}$.

We can now graph the equations $y = \sqrt{16 - x^2}$ and $y = -\sqrt{16 - x^2}$.

We enter both the positive and the negative equations [we do this using the **VAR**S option]. Then we use the above window settings. Finally press the **GRAPH** command.

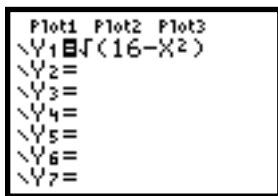

The final output is:

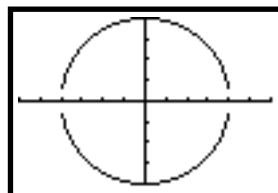
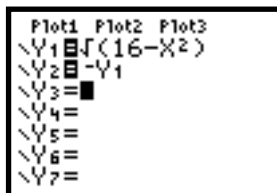
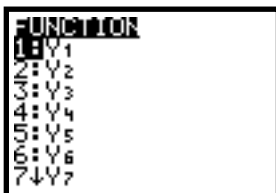

Using the window setting shown below, we obtain a distorted graph, as shown below:

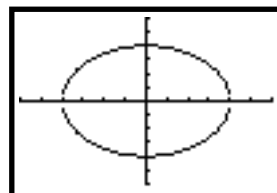
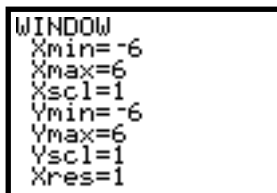

NB: You can also use the **ZOOM** options **4:ZDecimal** or **5:ZSquare** to generate correct graphs.

EXAMPLE 5.5

Determine the domain and range of the following relations.

- (a) $x^2 + y^2 = 4$.
- (b) $y > 2 - x, x < 0$.
- (c) $y = \frac{2}{x^2 + 1}, -1 \leq x < 2$

S
O
L
I
T
I
O
N

- (a) The relation $x^2 + y^2 = 4$ represents a circle of radius 2 units with its centre at the origin.

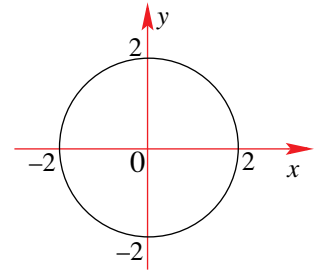

Note that we can only use values of x between -2 and 2 .
For example, if we have $x = 3$, then we must have
 $9 + y^2 = 4 \Rightarrow y^2 = -5$ for which there are no real solutions.
Therefore, the domain is $-2 \leq x \leq 2$ (or $[-2, 2]$).
The range is $-2 \leq y \leq 2$ (or $[-2, 2]$).

- (b) This time we have a subset of the cartesian plane.
That is, we are defining a region in the plane as opposed to a set of points lying on a curve.

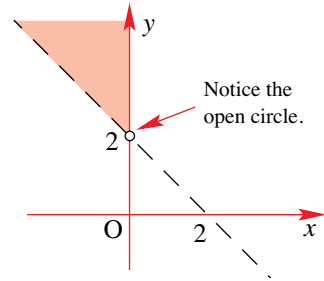

The domain has already been set as $\{x : x < 0\}$ (or $]-\infty, 0[$).
From our sketch, we see that the range is $\{y : y > 2\}$ (or $]2, \infty[$).

- (c) This time we make use of the TI-83 to sketch the graph:

The domain has already been specified as $[-1, 2[$, meaning that we include the value $x = -1$ (which generates a y -value of 1) but exclude the value $x = 2$ (which would have produced a y -value of $\frac{2}{5} = 0.4$).

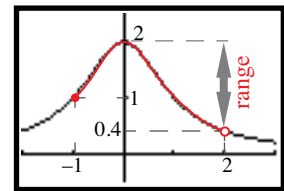

From the sketch, the range is therefore $]0.4, 2]$.

NB: Had we been given the relation $y = \frac{2}{x^2 + 1}$ without a specified domain, then its implied

domain would be $]-\infty, \infty[$. This time, unlike Example 5.4 (b), as $x^2 + 1$ will always be greater than or equal to one, there is no danger of ever dividing by zero (for any value of x). This would have then produced a range $]0, 2]$.

One of the key steps in determining properties of a relation is the ability to sketch its graph. We have already dealt with polynomials, however, there are many other relations that you will need to be able to sketch. The fact that you have access to a graphics calculator will make it easier for you to sketch graphs, however, it is still important that you have a ‘feel’ for the shape of some standard relations. We will deal with a number of relations in detail throughout this book, so, at this stage we will provide a ‘bank’ of the graphs for some standard relations.

Relation	Properties
$y = mx + c$ 	<p>1. Linear relation [straight line]</p> <p>2. Case (a): $m > 0$, y-intercept at $(0, c)$ increasing</p> <p>Case (b): $m < 0$ y-intercept at $(0, c)$ decreasing</p>

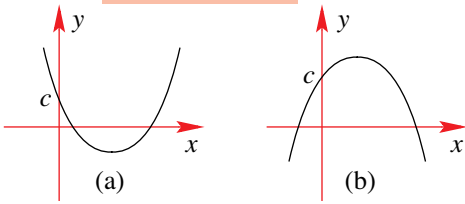
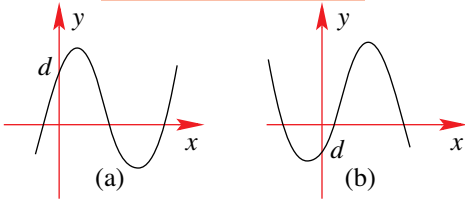
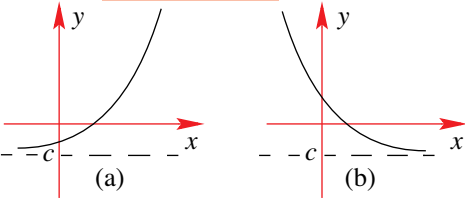
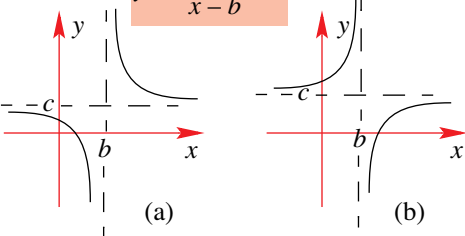
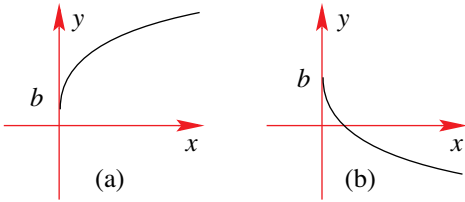
Relation	Properties
<p style="text-align: center;">$y = ax^2 + bx + c$</p> 	<ol style="list-style-type: none"> Quadratic relation [parabola] Case (a): $a > 0$, y-intercept at $(0, c)$ axis of symmetry at $x = -\frac{b}{2a}$. Case (b): $a < 0$ y-intercept at $(0, c)$ axis of symmetry at $x = -\frac{b}{2a}$.
<p style="text-align: center;">$y = ax^3 + bx^2 + cx + d$</p> 	<ol style="list-style-type: none"> Polynomial relation (of order 3) [cubic] Case (a): $a > 0$, y-intercept at $(0, d)$ Case (b): $a < 0$ y-intercept at $(0, d)$
<p style="text-align: center;">$y = a \times b^{kx} + c$</p> 	<ol style="list-style-type: none"> Exponential relation [exponential] Case (a): $a > 0, k > 0$ asymptote at $y = c$ increasing Case (b): $a < 0$ asymptote at $y = c$ decreasing <p>NB: If $a < 0$, then graphs of $y = a \times b^{kx}$ is first reflected about the x-axis.</p>
<p style="text-align: center;">$y = \frac{a}{x-b} + c$</p> 	<ol style="list-style-type: none"> Reciprocal relation [rectangular hyperbola] Case (a): $a > 0$, asymptote at $y = c$ and $x = b$ Case (b): $a < 0, k < 0$ asymptote at $y = c$ and $x = b$
<p style="text-align: center;">$y = a\sqrt{x} + b$</p> 	<ol style="list-style-type: none"> Square root relation [sideways parabola] Case (a): $a > 0$, y-intercept at $(0, b)$ increasing Case (b): $a < 0$ y-intercept at $(0, b)$ decreasing <p>NB: $y^2 = x$ is a sideways parabola, $y = \sqrt{x}$ is only 'half' of a sideways parabola.</p>

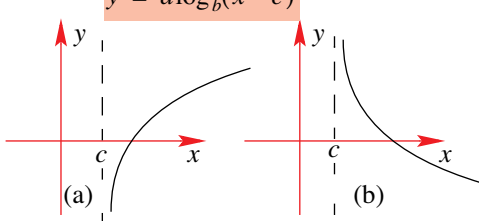
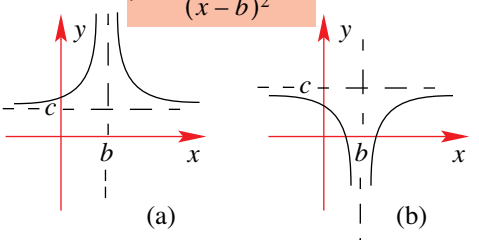
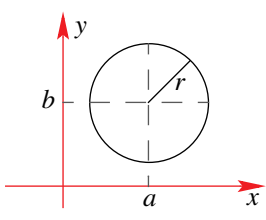
Relation	Properties
$y = a \log_b(x - c)$ 	<ol style="list-style-type: none"> 1. Logarithmic relation [log curve] 2. Case (a): $a > 0, b > 1$ asymptote at $x = c$ increasing Case (b): $a < 0, b > 1$ asymptote at $x = c$ decreasing
$y = \frac{a}{(x - b)^2} + c$ 	<ol style="list-style-type: none"> 1. Reciprocal squared relation [truncus] 2. Case (a): $a > 0$, asymptote at $y = c$ and $x = b$ Case (b): $a < 0$ asymptote at $y = c$ and $x = b$
$(x - a)^2 + (y - b)^2 = r^2$ 	<ol style="list-style-type: none"> 1. Circular relation [circle] 2. Radius r 3. Centre at (a, b) <p>NB: The equation $(x - a)^2 + (y - b)^2 = r^2$ can be rewritten as</p> $y = \pm \sqrt{r^2 - (x - a)^2} + b$ <p>with the positive root representing the top half and the negative root the bottom half.</p>

Remember, this ‘bank’ of relations is a mere sample of possible relations and are not necessarily given in their most general form.

EXERCISES 5.1

1. State the domain and range of the following relations.
 - (a) $\{(2,4), (3,-9), (-2,4), (3,9)\}$
 - (b) $\{(1,2), (2,3), (3,4), (5,6), (7,8), (9,10)\}$
 - (c) $\{(0,1), (0, 2), (1,1), (1,2)\}$

2. Find the range for each of the following.
 - (a) $\{(x,y): y = x + 1, x \in \mathbb{R}^+\}$
 - (b) $\{(x,y): y \geq x, x \geq 0\}$
 - (c) $y = x^2 + 2x + 1, x > 2$
 - (d) $y = 2x - x^2, x \in \mathbb{R}$
 - (e) $x^2 + y^2 = 9, -3 \leq x \leq 3$
 - (f) $x^2 - y^2 = 9, x \geq 3$
 - (g) $y = x - 1, 0 < x \leq 1$
 - (h) $y = 4 - x^2, -2 \leq x < 1$

MATHEMATICS – Higher Level (Core)

(i) $y = \sqrt{x}, x \geq 0$

(j) $y = \sqrt{x}, 1 \leq x \leq 25$

(k) $y = \frac{4}{x+1}, x > 0$

(l) $\{(x,y): y^2 = x, x \geq 1\}$

3. State the range and domain for each of the following relations.

(a)

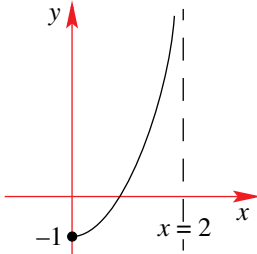

(b)

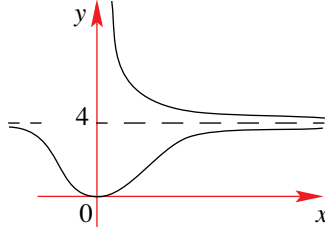

(c)

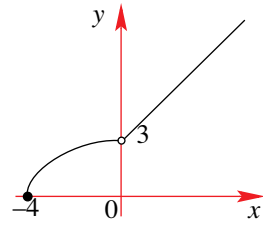

(d)

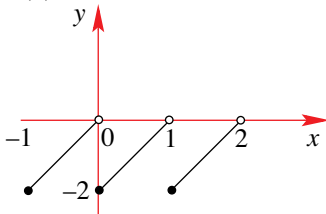

(e)

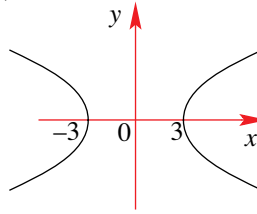

(f)

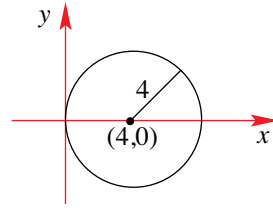

4. What types of relation are the following?

(a)

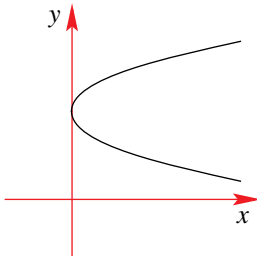

(b)

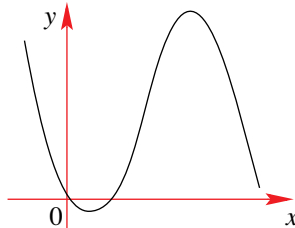

(c)

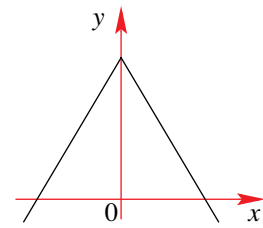

(d)

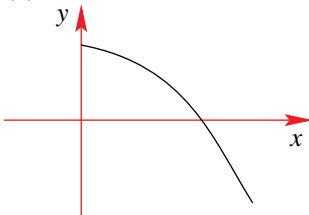

(e)

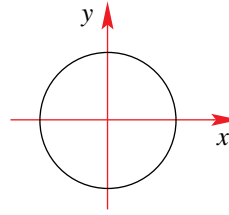

(f)

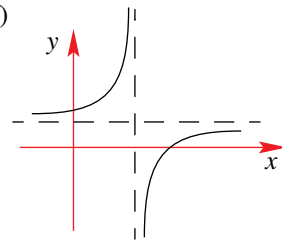

5. Determine the implied domain for each of the following relations.

(a) $y = \frac{2x}{x+2}$

(b) $y = \frac{3}{\sqrt{9-x}}$

(c) $y = \sqrt{16-x^2}$

(d) $y = \sqrt{x^2-4}$

(e) $xy - x = 3$

(f) $y = \frac{2}{x^2+1}$

(g) $y = \frac{2}{x^3+1}$

(h) $y = \sqrt{x+a}, a > 0$

(i) $y = \frac{a}{\sqrt{x-a}}, a > 0$

(j) $x^2 - y^2 = a^2$

(k) $y^2 - x^2 = a^2$

(l) $axy + y - x = a, a > 0$

6. Find the range of the following relations.

(a) $y = x - a, x < 0, a > 0$

(b) $y = \frac{ab}{x+1}, x \geq 0, ab > 0$

(c) $y = a^2x - ax^2, x \geq \frac{1}{2}a, a > 0$

(d) $y = a^2x - ax^2, x \geq \frac{1}{2}a, a < 0$

(e) $y = \frac{a}{x} + a, a > 0$

(f) $y = a - \frac{a}{x^2}, a > 0$

(g) $y = 2\sqrt{x-a} - a, a > 0$

(h) $y = \frac{2a}{\sqrt{a^2-x}}, a < 0$

5.2 FUNCTIONS

5.2.1 DEFINITIONS

There is a special group of relations which are known as **functions**. This means that every set of ordered pairs is a relation, but **every relation is not a function**. Functions then make up a subset of all relations.

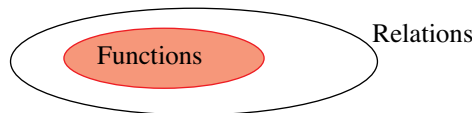

A function is defined as a relation that is either one to one or many to one. That is a function is a relation for which no ordered pairs have the same first element.

There are two ways to determine if a relation is a function.

Method 1: Algebraic approach

For Method One we use the given equation and determine the number of y -values that can be generated from one x -value.

EXAMPLE 5.6

Determine which (if any) of the following are functions.

(a) $y^3 - x = 2$

(c) $y^2 + x = 2$

S
O
L
U
T
I
O
N

(a) From $y^3 - x = 2$ we have that $y = \sqrt[3]{2+x}$, then for any given value of x , say $x = a$, we have that $y = \sqrt[3]{2+a}$ which will only ever produce one unique y -value.

Therefore, the relation $y^3 - x = 2$ is a function. In fact, it is a one to one function.

(b) From $y^2 + x = 2$ we have that $y^2 = 2 - x \Leftrightarrow y = \pm\sqrt{2-x}$. Then, for any given value of x , say $x = a$ (where $a \leq 2$), we have that $y = \pm\sqrt{2-a}$, meaning that we have two different y -values; $y_1 = \sqrt{2-a}$ and $y_2 = -\sqrt{2-a}$, for the same x -value. Therefore, this relation is not a function. In fact, it is a one-to-many relation.

Method 2: Vertical line Test

The method is quite simple:

- Step 1** Sketch the graph of the relation.
- Step 2** Make a visual check of the number of times a vertical line would cut the graph.
- Step 3** If the vertical line only ever cuts at one place for every value in the domain the relation is a function.

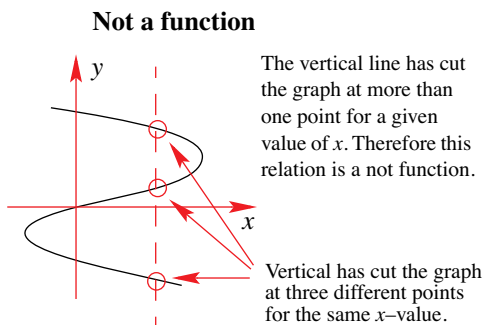
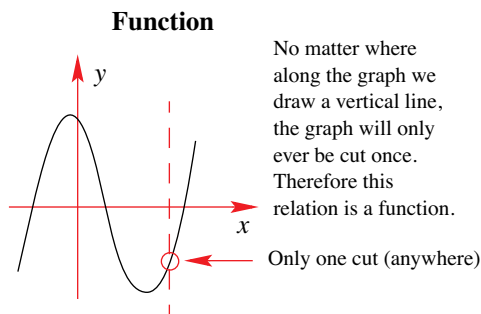

EXAMPLE 5.7

Which of the following defines a function?

- (a) $\{(0,2), (1,2), (2,1)\}$
- (b) $\{(x, y): y = x^3 + 1, x \in \mathbb{R}\}$
- (c) $y^2 = x, x \geq 0$
- (d) $\{(x,y): x^2 + y^2 = 16\}$

**S
o
l
u
t
i
o
n**

(a) Clearly, we have every first element of the ordered pairs different. This means that this relation is also a function.

(b) Using the TI-83 to provide a visual check:
From the graph shown, a vertical line drawn anywhere on the domain for which the relation is defined, will cut the graph at only one place.
This relation is therefore a function.

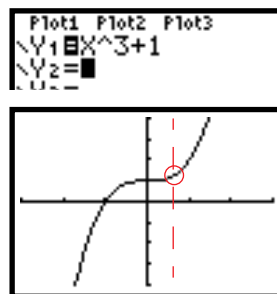

(c) Again we make use of a visual approach to determine if the relation is a function.
First we write the relation in a form that will enable us to enter it into the TI-83: $y^2 = x \Rightarrow y = \pm\sqrt{x}$

We can therefore define the relation $Y_1 = \sqrt{X}$ and $Y_2 = -\sqrt{X}$ and sketch both on the same set of axes.

Placing a vertical line over sections of the domain shows that the line cuts the graph in two places (except at the origin). Therefore this relation is not a function.

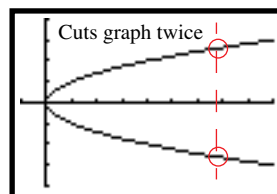

Algebraic proof

We can also determine if a relation is a function by using algebraic means.

Begin by choosing a value of x that lies in the domain. For example $x = 4$.

This gives the following equation: $y^2 = 4 \Rightarrow y = \pm\sqrt{4}$

From which we can say that when $x = 4$, $y = 2$ **and** $y = -2$, so that there are two ordered pairs, $(4,2)$ and $(4,-2)$. As we have two different y -values for one x -value this relation is not a function.

- (d) This relation describes the equation of a circle with radius 4 units and centre at the origin. The graph of this relation is shown alongside. The graph fails the vertical line test, and so is not a function.

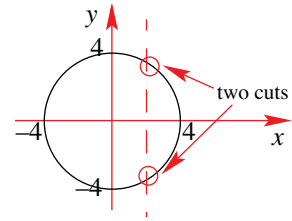

We now provide a formal definition together with commonly used notation for a function.

A function f , (or a mapping f), from a set X to a set Y is a relation that assigns to each element x in the set X a unique element y in the set Y .

The set X is called the **domain** of f and the set Y the **co-domain**. The element y is called the **image** of x under f and we denote this image by $f(x)$, the value of the function f at x (read as; f of x).

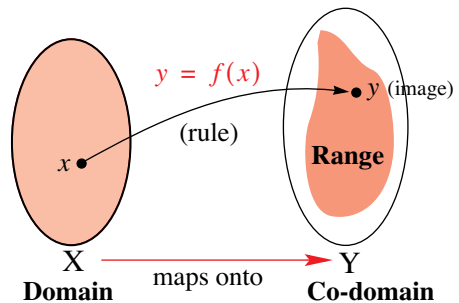

We write this mapping as: $f: x \mapsto f(x)$

We can also write this mapping as follows

1. $f: X \mapsto Y$, where $y = f(x)$
2. $f: X \mapsto Y, y = f(x)$
3. $y = f(x), x \in X$

It is important to realise that the range of f is not necessarily the set Y . The **range** of f is actually a subset of Y (sometimes it could also be equal to Y). Set Y , i.e., the co-domain, describes the **types** of numbers that will be produced when f is applied to different x -values — not necessarily which numbers will result! The range of f is given by the values of $f(x)$.

Translating the mathematical notation into English we have the following:

$f: X \mapsto Y$, where $f(x) =$ rule in terms of x
 “ f is such that the set X maps onto the set Y where f of x is equal to . . .”

Notice that f describes not only the rule, $f(x)$, but also the domain, X .

EXAMPLE 5.8

For the function $f(x) = x^3 + 1, x \in \mathbb{R}$ find

- (a) $f(-1), f(2)$. (b) the element of the domain that has an image of 28.

**S
o
l
u
t
i
o
n**

(a) $f(x) = x^3 + 1, x \in \mathbb{R} \Rightarrow f(-1) = (-1)^3 + 1 = -1 + 1 = 0$.

Similarly, $f(2) = 2^3 + 1 = 9$.

- (b) If the image is 28, then we want the value of x for which $f(x) = 28$.

We then have, $f(x) = 28 \Leftrightarrow x^3 + 1 = 28$

$$\Leftrightarrow x^3 = 27$$

$$\Leftrightarrow x = 3$$

[Taking the cube root of both sides]

Therefore, the element of the domain that has an image of 28 is 3.

EXAMPLE 5.9

Determine the range of the function $f: \{x: x \geq 0\} \mapsto \mathbb{R}, f(x) = x + 1$.

**S
o
l
u
t
i
o
n**

First note that the co-domain is given by \mathbb{R} , the set of real numbers – meaning that all image values will be real. To determine the actual range of this function we sketch its graph.

From the graph, the only possible values of y are those for which $y \geq 1$. In this case, because $x = 0$ is included in the domain, we also include the value $y = 1$ in the range. Therefore, we have a closed circle at the end point.

The range of f is then given by $\{y: y \geq 1\}$ (or $[1, \infty)$).

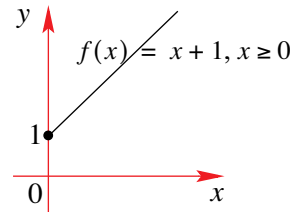

EXAMPLE 5.10

For the function $f(x) = x^2 - 3, x \in \mathbb{R}$ find

- (a) $f(6)$ (b) $f(x + 1)$ (c) $f(x + h) - f(x)$

**S
o
l
u
t
i
o
n**

- (a) To determine the value of $f(6)$, we ‘replace’ the x -term in the rule of $f(x)$ with the number ‘6’ i.e., $f(6) = (6)^2 - 3 = 36 - 3 = 33$.

- (b) This time we ‘replace’ the x -term in the rule of $f(x)$ with ‘ $x + 1$ ’:

So, $f(x + 1) = (x + 1)^2 - 3 = x^2 + 2x + 1 - 3 = x^2 + 2x - 2$.

- (c) $f(x + h) - f(x) = (x + h)^2 - 3 - (x^2 - 3)$
 $= (x^2 + 2xh + h^2) - \cancel{3} - x^2 + \cancel{3}$
 $= 2xh + h^2$

EXAMPLE 5.11

Consider the function $g: \{x: -1 \leq x \leq 2\} \mapsto \mathbb{R}$, where $g(x) = x^2 + 2$,

- (a) Find $g(-1)$, $g(0)$, and $g(2)$. (b) Determine the range of g .

S
o
l
u
t
i
o
n

(a) $g(-1) = (-1)^2 + 2 = 3$
 $g(0) = (0)^2 + 2 = 2$
 $g(2) = (2)^2 + 2 = 6$

- (b) To determine the range of the function g , we first need to sketch its graph.

We begin by sketching the graph of $y = x^2 + 2$ for all real values of x . Then, as the domain is restricted to $x \in [-1, 2]$. This means that we ‘remove’ the parts of the graph that lie outside this domain. This leaves the required part of the graph.

From our graph of g , the range of this function is given by $\{y: 2 \leq y \leq 6\}$ (or $[2, 6]$).

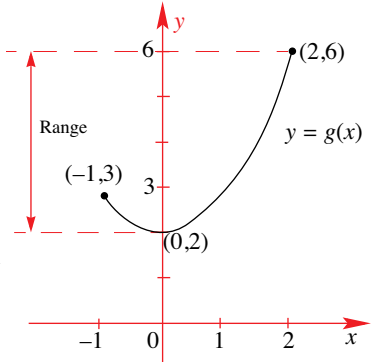

EXAMPLE 5.12

Consider the function $f: \mathbb{R} \mapsto \mathbb{R}$, where $f(x) = 2 - x^2$.

- (a) Find i. $f(5)$ ii. $\{x: f(x) = -7\}$ iii. $\{x: f(1-x) = -7\}$
 (b) What type of function is f ?

S
o
l
u
t
i
o
n

(a) i. $f(5) = 2 - 5^2 = 2 - 25 = -23$
 ii. $f(x) = -7 \Leftrightarrow 2 - x^2 = -7 \Leftrightarrow x^2 = 9$
 $\therefore x = \pm 3$

So, the solution set is $\{-3, 3\}$.

iii. $f(1-x) = -7 \Leftrightarrow 2 - (1-x)^2 = -7$
 $\Leftrightarrow (1-x)^2 = 9$
 $\Leftrightarrow 1-x = \pm 3$

Therefore, the solution set is $\{-2, 4\}$.

- (b) From (a) we obtained two values of x for one value of y and so $f(x)$ is a many-to-one function.

EXERCISES 5.2

1. A function is defined as follows, $f: x \mapsto 2x + 3, x \geq 0$.
 - (a) Find the value of $f(0), f(1)$.
 - (b) Evaluate the expressions i. $f(x + a)$ ii. $f(x + a) - f(x)$
 - (c) Find $\{x: f(x) = 9\}$.

2. If $f(x) = \frac{x}{x+1}, x \in [0, 10]$, find
 - (a) $f(0), f(10)$.
 - (b) $\{x: f(x) = 5\}$.
 - (c) the range of $f(x) = \frac{x}{x+1}, x \in [0, 10]$.

3. For the mapping $x \mapsto 2 - \frac{1}{2}x^2, x \in \mathbb{R}$, find
 - (a) $f(x + 1), f(x - 1)$.
 - (b) a , given that $f(a) = 1$.
 - (c) b , given that $f(b) = 10$.

4. A function is defined as follows, $y = x^3 - x^2, x \in [-2, 2]$.
 - (a) Find the value(s) of x such that $y = 0$.
 - (b) Sketch the graph of $y = x^3 - x^2, x \in [-2, 2]$ and determine its range.

5. The function f is defined as $f:]-\infty, \infty[\mapsto \mathbb{R}$, where $f(x) = x^2 - 4$.
 - (a) Sketch the graph of i. f
ii. $y = x + 2, x \in]-\infty, \infty[$
 - (b) Find i. $\{x: f(x) = 4\}$ ii. $\{x: f(x) = x + 2\}$

6. Which of the following relations are also functions?

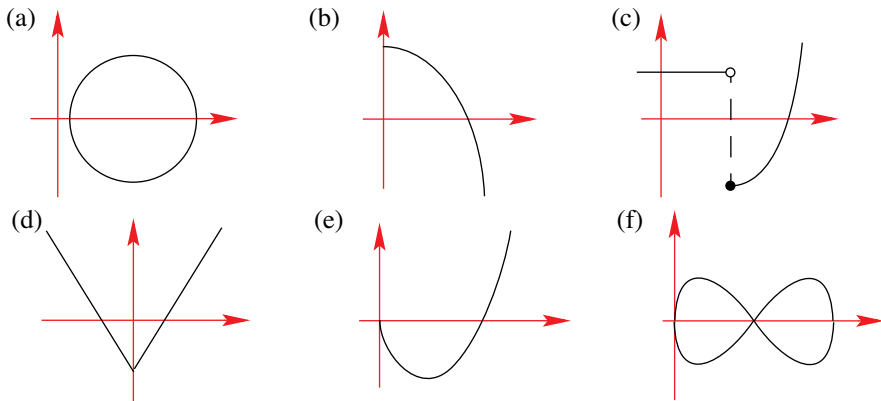

7. Use both *visual tests* and *algebraic tests* to show that the following relations are also functions.
 - (a) $x \mapsto x^3 + 2, x \in]0, 5[$
 - (b) $x \mapsto \sqrt{x} + 1, x \in [0, 9[$
 - (c) $\{(x, y): y^3 = x + 1, x \in \mathbb{R}\}$
 - (d) $\{(x, y): y = x^2 + 1, x \in \mathbb{R}\}$

8. Use an algebraic method to decide which of the following relations are also functions.

(a) $f: x \mapsto \frac{1}{x}, x \in \mathbb{R} \setminus \{0\}$

(b) $\{(x, y): y^2 - x = 9, x \geq -9\}$

(c) $\{(x, y): y^2 - x^2 = 9, x \geq -9\}$

(d) $f(x) = \frac{1}{x^2} + 1, x \neq 0$

(e) $f(x) = 4 - 2x^2, x \in \mathbb{R}$

(f) $f: x \mapsto \frac{4}{x+1}, x \in \mathbb{R} \setminus \{-1\}$

9. Sketch the graph of $f: x \mapsto \frac{x^2}{x^2 + 2}, x \in \mathbb{R}$ and use it to

- (a) show that f is a function.
 (b) determine its range.

10. A function is defined by $f: x \mapsto \frac{x+10}{x-8}, x \neq 8$ and $x \geq 0$.

- (a) Determine the range of f .
 (b) Find the value of a such that $f(a) = a$.

11. Consider the functions $h(x) = \frac{1}{2}(2^x + 2^{-x})$ and $k(x) = \frac{1}{2}(2^x - 2^{-x})$.

- (a) Show that $2[h(x)]^2 = h(2x) + 1$.
 (b) If $[h(x)]^2 - [k(x)]^2 = a$, find the constant a .

12. Which of the following functions are identical? Explain

(a) $f(x) = \frac{x}{x^2}$ and $h(x) = \frac{1}{x}$.

(b) $f(x) = \frac{x^2}{x}$ and $h(x) = x$.

(c) $f(x) = x$ and $h(x) = \sqrt{x^2}$.

(d) $f(x) = x$ and $h(x) = (\sqrt{x})^2$.

13. Find the the largest possible subset X of \mathbb{R} , so that the following relations are one to one increasing functions

(a) $f: X \rightarrow \mathbb{R}$, where $f(x) = x^2 + 6x + 10$

(b) $f: X \rightarrow \mathbb{R}$, where $f(x) = \sqrt{9 - x^2}$

(c) $f: X \rightarrow \mathbb{R}$, where $f(x) = \sqrt{x^2 - 9}$

(d) $f: X \rightarrow \mathbb{R}$, where $f(x) = \frac{1}{3x - x^2}, x \neq 0, 3$

14. An isosceles triangle ABC has two side lengths measuring 4 cm and a variable altitude. Let the altitude be denoted by x cm.

- (a) Find, in terms of x , a relation for
 i. its perimeter, $p(x)$ cm and specify its implied domain.
 ii. its area, $A(x)$ cm² and specify its implied domain.
 (b) Sketch the graph of
 i. $p(x)$ and determine its range.
 ii. $A(x)$ and determine its range.

5.3 SOME STANDARD FUNCTIONS

5.3.1 HYBRID FUNCTIONS AND CONTINUITY

A hybrid function is a relation that consists of more than one function, where each function is defined over a mutually exclusive domain. Generally, these functions take on the following form:

$$f(x) = \begin{cases} g_1(x) & x \in X_1 \\ g_2(x) & x \in X_2 \\ \vdots & \vdots \end{cases} \quad \text{where } X_i \cap X_j = \emptyset, i \neq j$$

EXAMPLE 5.13

Sketch the graph of $f(x) = \begin{cases} -2 & x \leq 1 \\ x + 1 & x > 1 \end{cases}$, stating its domain and range.

Solution We first look at the domain of the function. In this instance we have that $x \geq 1$ and $x < 1$, so in fact we have that $x \in]-\infty, \infty [$ (or simply, $x \in \mathbb{R}$).

To determine the range we will need to sketch the graph of f .
Hybrid functions can be sketched using the TI-83 (use the **TEST** menu)

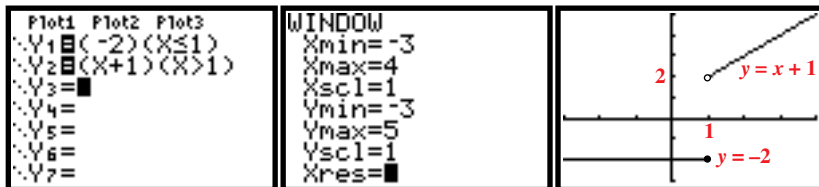

From the graph the range is given by the set $\{y : y > 2\} \cup \{-2\}$.

A few important points to note:

1. Even though $x = 1$ is not in the domain of the $y = x + 1$ part of the function, we have still used $x = 1$ to find the value of $y = 2$.
2. At $x = 1$, we have what is known as a **discontinuity**.

EXAMPLE 5.14

Sketch the graph of $f(x) = \begin{cases} x^2 - 4 & x < -2 \\ \sqrt{4 - x^2} & -2 \leq x \leq 2 \\ 4 - x^2 & x > 2 \end{cases}$

- (a) State the domain of f .
- (b) Find the range of f .

S
o
l
u
t
i
o
n

This time we have a hybrid function with three branches; $y_1 = x^2 - 4, x < -2$ (a parabola), $y_2 = \sqrt{4 - x^2}, -2 \leq x \leq 2$ (a semi-circle) and $y_3 = 4 - x^2, x > 2$ (a parabola). Individually they are straight forward to sketch. In fact, it is not that much more difficult to sketch the hybrid function either. The ‘trick’ is to sketch each branch in its entirety and then remove those sections that do not belong.

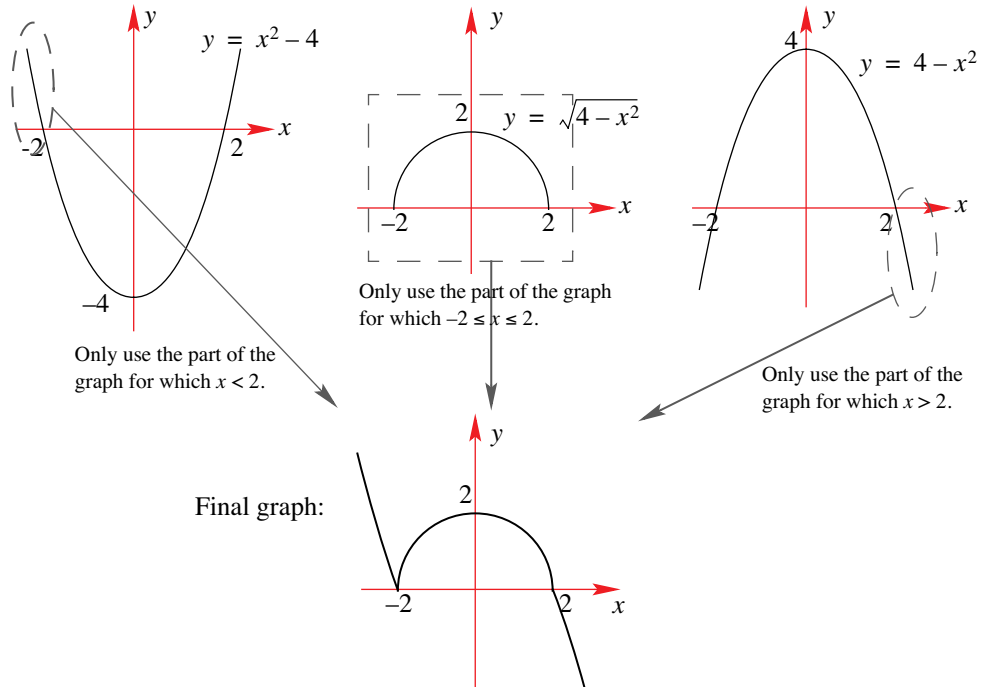

- (a) The domain is given by $]-\infty, 2[\cup [-2, 2] \cup]2, \infty[=]-\infty, \infty[$ (or simply, \mathbb{R}).
- (b) From the graph, the range can be seen to be \mathbb{R} .

- Nb:
1. At $x = 2, y = 0$ and at $x = -2, y = 0$.
 2. Unlike the previous example, the graph is **continuous** at $x = \pm 2$.
 3. We could have still made use of the TI-83 for this problem:

```

Plot1 Plot2 Plot3
Y1=(X^2-4)(X<-2)
Y2=(4-X^2)(-2<=X
)<=2)
Y3=(4-X^2)(X>2)
Y4=
Y5=
    
```

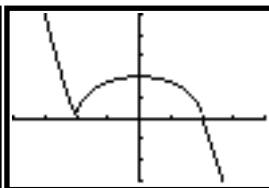

Notice the distortion of the semi-circle (see §5.1.5).

Continuity

A graph is said to be continuous over a domain if it can be drawn without lifting the pen from the paper in that domain. In other words, there are no breaks.

Eventhough this is a rather weak ‘definition’ it does provide the basics behind the concept of continuity. If a relation is **not continuous** at some point (i.e., there is a break in the graph), we then say that the graph is **discontinuous** at that point.

MATHEMATICS – Higher Level (Core)

The three types of discontinuities that we will encounter can be summarised as follows:

‘Jump’ discontinuity

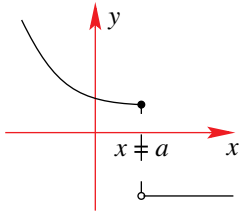

This function is continuous for all real values of x except at $x = a$. At $x = a$, there exists a ‘jump’ discontinuity.

‘Asymptotic’ discontinuity

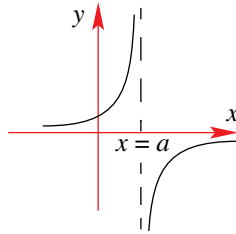

This function is continuous for all real values of x except at $x = a$. At $x = a$, there exists an ‘asymptotic’ discontinuity.

‘Missing point’ discontinuity

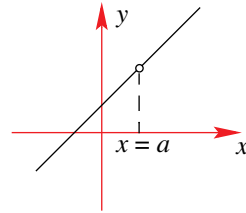

This function is continuous for all real values of x except at $x = a$. At $x = a$, there exists an ‘missing point’ discontinuity.

EXAMPLE 5.15

For what value of a will the function $y = \begin{cases} x^2 + a, & x > 1 \\ -x + 4, & x \leq 1 \end{cases}$ be

continuous?

S We begin by treating this function in the same way that we have
I treated other hybrid functions. We first sketch its graph (for an
u unknown value of a). In this instance we have drawn the graph with
t $y = 1 + a$ lying below $y = 4$ (it would make no difference if we had
i placed $y = 1 + a$ above $y = 4$).

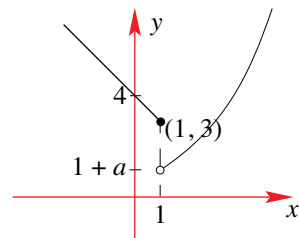

n Now, for the function to be continuous there must be no jump at $x = 1$, that is, we must have the two branches meeting at $x = 1$.

Therefore we must have that $1 + a = 3 \Leftrightarrow a = 2$.

EXAMPLE 5.16

For what value of b will $f(x) = \begin{cases} -x + 4, & x > 3 \\ 2 - \sqrt{x - b}, & x \leq 3 \end{cases}$ be continuous?

S At $x = 3$, we have $f(3) = 2 - \sqrt{3 - b}$.

If $f(x)$ is to be continuous then the two branches of the graph must meet at $x = 3$.

That is, we must have that $2 - \sqrt{3 - b} = 1 \Leftrightarrow \sqrt{3 - b} = 1$
 $\therefore 3 - b = 1$
 $\Leftrightarrow b = 2$

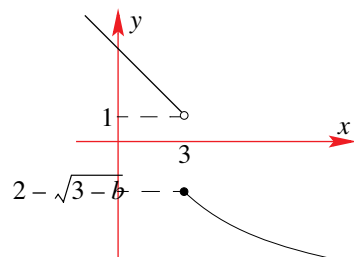

EXERCISES 5.3.1

1. Sketch the graphs of the following functions

$$(a) \quad f(x) = \begin{cases} -x + 2, & x > 3 \\ 1, & x \leq 3 \end{cases}$$

$$(b) \quad f(x) = \begin{cases} x^2 + 2, & x > -1 \\ 3, & x \leq -1 \end{cases}$$

$$(c) \quad f(x) = \begin{cases} \sqrt{x}, & x \geq 4 \\ 6 - x, & x < 4 \end{cases}$$

$$(d) \quad f(x) = \begin{cases} \frac{1}{x}, & x > 1 \\ 2 - x^2, & x \leq 1 \end{cases}$$

2. Sketch the graphs of the following functions

$$(a) \quad f(x) = \begin{cases} -2, & x < 0 \\ x - 2, & 0 \leq x \leq 4 \\ 2, & x > 4 \end{cases}$$

$$(b) \quad h(x) = \begin{cases} \sqrt{-x}, & x \leq -1 \\ 1 - x^2, & -1 < x < 1 \\ -\sqrt{x}, & x \geq 1 \end{cases}$$

3. Sketch the graphs of the following functions

$$(a) \quad h(x) = \begin{cases} x^3 + 1, & x > 0 \\ -1, & x \leq 0 \end{cases}$$

$$(b) \quad g(x) = \begin{cases} x + 2, & x > 1 \\ x^2 - 1, & x \leq 1 \end{cases}$$

$$(c) \quad f(x) = \begin{cases} \frac{x}{x+1}, & x \geq 0 \\ 1, & x < 0 \end{cases}$$

$$(d) \quad f(x) = \begin{cases} 2 - \sqrt{x}, & x > 0 \\ x + 3, & x \leq 0 \end{cases}$$

4. Sketch the graphs of the following functions

$$(a) \quad f(x) = \begin{cases} -4, & x < -2 \\ x^2 - 4, & -2 \leq x \leq 2 \\ 4, & x > 2 \end{cases}$$

$$(b) \quad h(x) = \begin{cases} \sqrt{2-x}, & x \leq -2 \\ -2x, & -2 < x < 2 \\ -\sqrt{x+2}, & x \geq 2 \end{cases}$$

5. Sketch the graphs of the following functions

$$(a) \quad f(x) = \begin{cases} \frac{1}{x+1}, & x \geq 0 \\ a, & x < 0 \end{cases}, a > 1$$

$$(b) \quad f(x) = \begin{cases} a + x^2, & x > 0 \\ x + 3, & x \leq 0 \end{cases}, a < -2$$

6. For what value(s) of a will the following functions be continuous? Sketch their graphs.

$$(a) \quad f(x) = \begin{cases} ax + 1, & x > 1 \\ 5, & x \leq 1 \end{cases}$$

$$(b) \quad h(x) = \begin{cases} 2x - 4, & x \geq 2 \\ a - 2x, & x < 2 \end{cases}$$

$$(c) \quad f(x) = \begin{cases} ax^3 - 1, & x > 2 \\ 3 + x^2, & x \leq 2 \end{cases}$$

$$(d) \quad h(x) = \begin{cases} \frac{1}{a}x^2 + 1, & x \geq 2 \\ ax + 1, & x < 2 \end{cases}$$

7. Given that $-\frac{1}{2} \leq \frac{x}{x^2+1} \leq \frac{1}{2}$, sketch the graph of $f(x) = \frac{2ax}{x^2+1}$ for $x \in]-\infty, \infty[$, where

$a > 0$. For what value(s) of a will the function $h(x) = \begin{cases} \frac{2ax}{x^2+1}, & x \geq 1 \\ 4 & x < 1 \end{cases}$ be continuous?

Sketch the graph of h .

5.3.2 THE ABSOLUTE VALUE FUNCTION

The absolute value function is defined as

$$y = |x| = \sqrt{x^2} = \begin{cases} x & \text{if } x \geq 0 \\ -x & \text{if } x < 0 \end{cases}$$

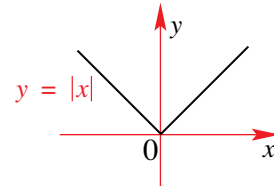

That is, sketch the graph of $y = x$ for $x \geq 0$, and then sketch the graph of $y = -x$ for $x < 0$.

Similarly, the function $x \mapsto |ax + b|$, represents the absolute value of the linear function $y = ax + b$.

EXAMPLE 5.17

Sketch the graph of (a) $y = |x - 2|$

(b) $y = |x| + 1$

(c) $y = |2x + 1|$

Solution

Parts (a) and (b) are best done by considering the functions as translations of the basic absolute value function. That is, the graph of $y = |x - 2|$ is in fact the graph of $y = |x|$ translated two units to the left. While the graph of $y = |x| + 1$ is in fact the graph of $y = |x|$ translated one unit vertically up. So, we have:

(a)

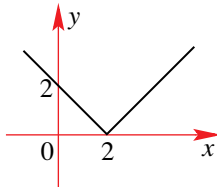

(b)

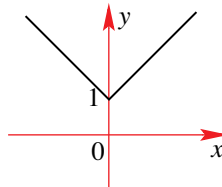

We could have used the definition to sketch the graphs above. This is done as follows:

(a) By definition, $y = |x - 2| = \begin{cases} x - 2 & \text{if } x - 2 \geq 0 \\ -(x - 2) & \text{if } x - 2 < 0 \end{cases} = \begin{cases} x - 2 & \text{if } x \geq 2 \\ 2 - x & \text{if } x < 2 \end{cases}$.

Then, sketch the straight line $y = x - 2$ for $x \geq 2$ and $y = 2 - x$ for $x < 2$.

(b) By definition, $y = |x| + 1 = \begin{cases} x & \text{if } x \geq 0 \\ -x & \text{if } x < 0 \end{cases} + 1 = \begin{cases} x + 1 & \text{if } x \geq 0 \\ -x + 1 & \text{if } x < 0 \end{cases}$.

Notice that because there are no restrictions on '+ 1', we add it to both branches. Then, sketch the straight line $y = x + 1$ for $x \geq 0$ and $y = 1 - x$ for $x < 0$.

$$(c) \quad \text{By definition } y = |2x + 1| = \begin{cases} 2x + 1 & \text{if } 2x + 1 \geq 0 \\ -(2x + 1) & \text{if } 2x + 1 < 0 \end{cases} = \begin{cases} 2x + 1 & \text{if } x \geq -\frac{1}{2} \\ -2x - 1 & \text{if } x < -\frac{1}{2} \end{cases}$$

Then, sketch the straight lines $y = 2x + 1$ for $x \geq -\frac{1}{2}$
and $y = -2x - 1$ for $x < -\frac{1}{2}$

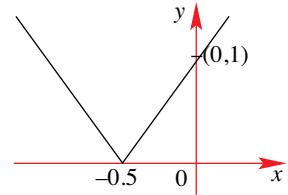

Notice that in fact, all we have done in part (c) is to sketch the graph of $y = 2x + 1$, and then reflect (about the x -axis) any part of the graph that was drawn below the x -axis.

That part of the graph that lies below the x -axis is reflected so that it lies above the x -axis.

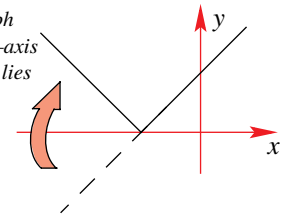

We can also make use of the TI-83 to sketch graphs of absolute value functions:

EXAMPLE 5.18

Find the range of the following functions

- (a) $x \mapsto |3 - 2x|, x \in \mathbb{R}$
- (b) $y = |x + 1| + |x - 1|, x \in \mathbb{R}$
- (c) $y = |x - 4| - 2, x \in \mathbb{R}$

Solution

- (a) Use the **MATH** menu and then selecting the **NUM** option, we can choose the **abs(** option. After ‘pasting’ the **abs(** command, enter the equation as shown on the screen.

```
Plot1 Plot2 Plot3
Y1=abs(3-2X)
Y2=
Y3=
Y4=
Y5=
Y6=
Y7=
```

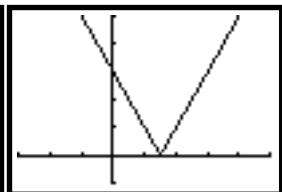

From the given graph, the range is defined as $\{y : y \geq 0\}$. As before, we enter the required options and obtain the following:

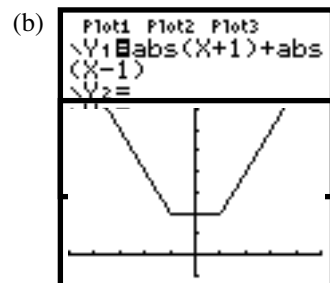

range = $[2, \infty [$

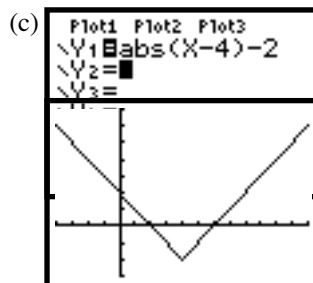

range = $[-2, \infty [$

MATHEMATICS – Higher Level (Core)

Notice that the TI-83 has made sketching the graph of $y = |x + 1| + |x - 1|$, $x \in \mathbb{R}$ a relatively easy task. Without using the TI-83, we would need to look at the overlapping domains and then sketch those parts of each equation that correspond to the overlapping domains.

In this instance we have three overlapping regions:

$$y = |x + 1| + |x - 1| = \begin{cases} x + 1 & \text{if } x \geq -1 \\ -x - 1 & \text{if } x < -1 \end{cases} + \begin{cases} x - 1 & \text{if } x \geq 1 \\ 1 - x & \text{if } x < 1 \end{cases}$$

$$= \begin{cases} (x + 1) + (x - 1) & \text{if } x \geq 1 \\ (x + 1) + (1 - x) & \text{if } -1 \leq x < 1 \\ (-x - 1) + (1 - x) & \text{if } x < -1 \end{cases} = \begin{cases} 2x & \text{if } x \geq 1 \\ 2 & \text{if } -1 \leq x < 1 \\ -2x & \text{if } x < -1 \end{cases}$$

We now look at the more general form of the absolute value function, i.e., $y = |f(x)|$.
By definition we have that

$$y = |f(x)| = \begin{cases} f(x) & \text{if } f(x) \geq 0 \\ -f(x) & \text{if } f(x) < 0 \end{cases}$$

However, depending on the expression of $f(x)$, solving the inequalities $f(x) \geq 0$ and $f(x) < 0$ can be time consuming. So, to sketch a graph of $y = |f(x)|$ it is often convenient to first sketch the graph of $y = f(x)$ and then we reflect (about the x -axis) whatever parts of this graph lie below the x -axis. That is:

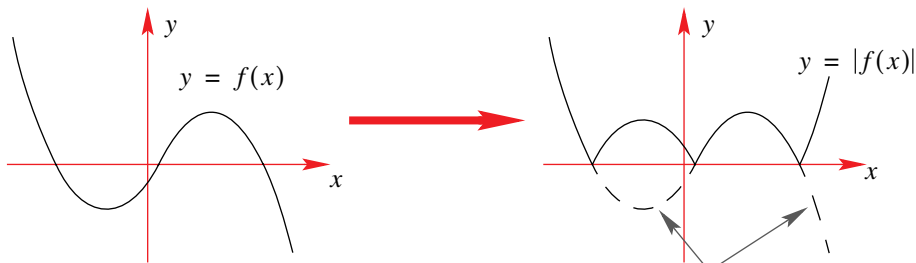

These sections of the original graph have been reflected about the x -axis.

EXAMPLE 5.19

Sketch the graph of $x \mapsto |x^2 - 4x|$, $x \in \mathbb{R}$

S
O
L
I
T
I
O
N

We start by sketching the graph of $f(x) = x^2 - 4x$ and then follow the above process.

That is, once we have sketched the graph of $f(x) = x^2 - 4x$ we then reflect (about the x -axis) the part of the graph that lies below the x -axis:

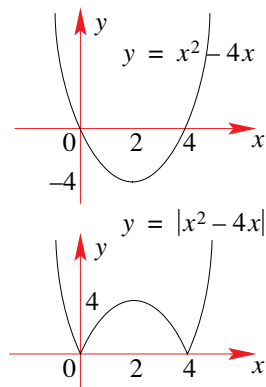

Sometimes, rather than considering the absolute value of the whole expression, we have equations for which we consider the absolute value of the independent variable only. That is, rather than sketching the graph of $y = |f(x)|$ we want to sketch the graph of $y = f(|x|)$. So, what does the graph of $y = f(|x|)$ look like. Obviously it will depend on the original function $f(x)$, however, we can deduce the general properties or transformation in getting from $f(x)$ to $f(|x|)$.

We begin by considering a number of examples using the TI-83:

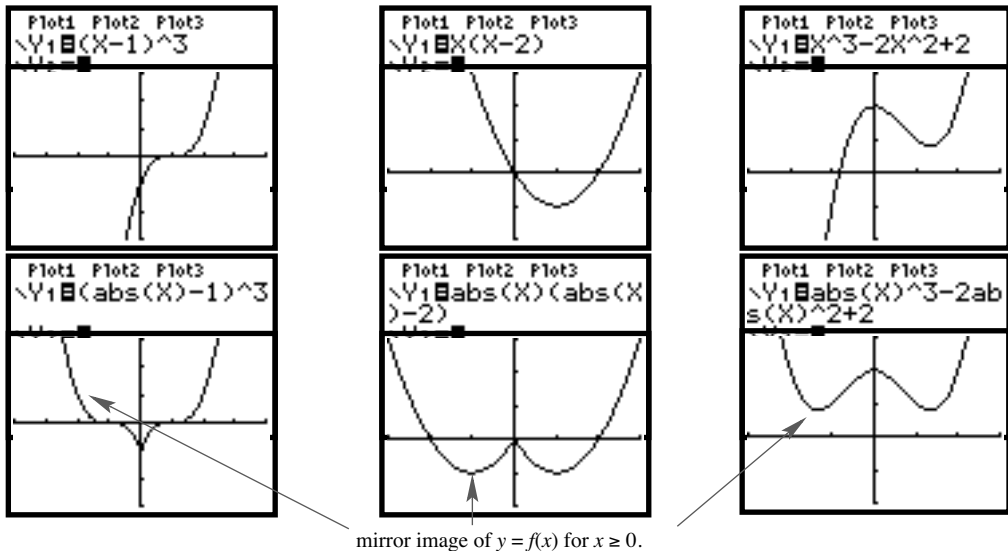

From these graphs it is clear that the graph of $y = f(|x|)$ is obtained from the graph of $y = f(x)$ by **replacing** the part of $y = f(x)$ that lies in the domain $x \leq 0$ with a mirror image (about the y -axis) of the part of $y = f(x)$ that lies in the domain $x \geq 0$.

To sketch the graph of $y = f(|x|)$ we discard that part of $y = f(x)$ that is sketched for $x < 0$ and replace it with the reflection (about the y -axis) of $y = f(x)$ that is sketched for $x \geq 0$.

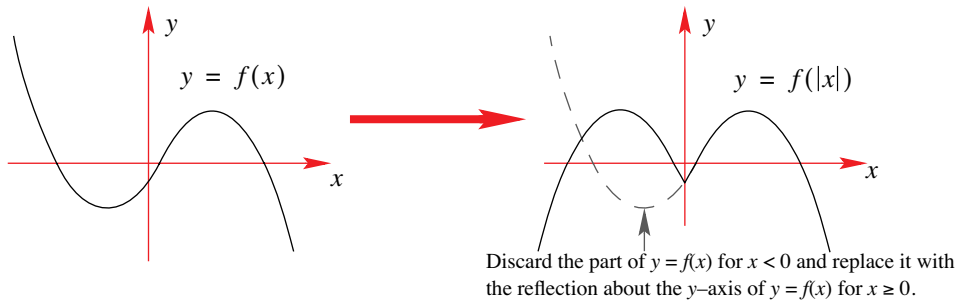

EXAMPLE 5.20

For each of the functions $y = f(x)$ sketch the graph of $y = f(|x|)$

- (a) $f(x) = x^2 - 4x$
- (b) $f(x) = 1 - \sqrt{x+2}$

S
o
l
u
t
i
o
n

- (a) We start by sketching the graph of $f(x) = x^2 - 4x$ and then follow the process just described:

Step 1: Discard the part of $y = f(x)$ for $x < 0$.

Step 2: Replace it with the mirror image (about the y -axis) of $y = f(x)$ for $x \geq 0$.

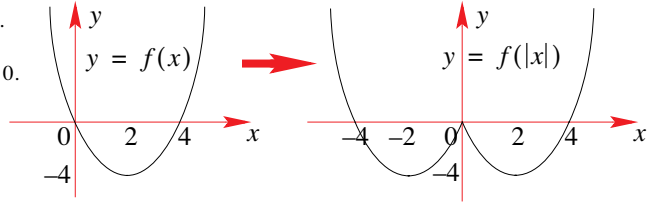

- (b) Again we start by sketching the graph of $f(x) = 1 - \sqrt{x+2}$ and then follow the process just described:

Step 1: Discard the part of $y = f(x)$ for $x < 0$.

Step 2: Replace it with the mirror image (about the y -axis) of $y = f(x)$ for $x \geq 0$.

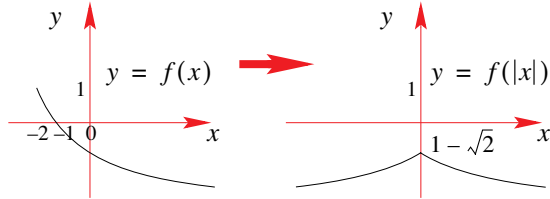

EXERCISES 5.3.2

- On separate sets of axes, sketch the graphs of the following functions for $x \in \mathbb{R}$.

(a) $f(x) = 2x $	(b) $f(x) = x + 2$	(c) $f(x) = x + 1 $
(d) $f(x) = 4x - 2 $	(e) $f(x) = 2x - 4$	(f) $f(x) = - x + 1$
(g) $g(x) = 3 - x $	(h) $f(x) = \left 5 - \frac{1}{2}x\right $	(i) $g(x) = \left \frac{4-x}{2}\right $
- On separate sets of axes, sketch the graphs of the following functions for $x \in \mathbb{R}$.

(a) $g(x) = x^2 - 9 $	(b) $h(x) = 2x - x^2 $	(c) $h(x) = (x-1)(2+x) $
(d) $f(x) = x(3-x) $	(e) $g(x) = x x+1 $	(f) $f(x) = x^3 - 8x^2 $
(g) $f(x) = 8 - x^3 $	(h) $f(x) = 8 - x^3 $	(i) $f(x) = x^3 - 1 - 1$
- On separate sets of axes, sketch the graphs of the following functions for $x \in \mathbb{R}$ and determine the range of each function.

(a) $f(x) = x+1 + x-1 $	(b) $f(x) = x+2 + x-2 $
(c) $f(x) = x + x $	(d) $f(x) = x - x $
(e) $f(x) = x+2 - x-2 $	(f) $f(x) = x+1 - x-1 $
- On separate sets of axes, sketch the graphs of the following functions

(a) $f(x) = x x $	(b) $f(x) = \frac{ x }{x}, x \neq 0$
(c) $f(x) = \left \frac{1}{x} + 1\right $	(d) $f(x) = \left \frac{1}{x} - 1\right $

- 5.** For each of the functions $y = f(x)$ sketch the graph of $y = f(|x|)$.
- (a) $f(x) = 2x^2 - x$ (b) $f(x) = 3 + (x - 2)^2$ (c) $f(x) = x^3 - 8$
 (d) $f(x) = x - 4$ (e) $f(x) = \frac{1}{x} - 1$ (f) $f(x) = \sqrt{x + 4}$
 (g) $f(x) = x(4 - x)$ (h) $f(x) = \frac{1}{x - 1}, x \neq 1$ (i) $f(x) = |x - 2|$
- 6.** For each of the functions $y = f(x)$ sketch the graph of $y = f(|x|)$.
- (a) $f(x) = \begin{cases} x - 4, & x > 3 \\ 8 - x^2, & x \leq 3 \end{cases}$ (b) $f(x) = \begin{cases} x^3 - 1, & x > 1 \\ 1 - x^2, & x \leq 1 \end{cases}$
 (c) $f(x) = \begin{cases} \frac{1}{x - 1}, & x < 1 \\ \sqrt{x} + 2, & x \geq 1 \end{cases}$ (d) $f(x) = \begin{cases} |x^2 - 2x|, & x \geq 1 \\ |x| - 1, & x < 1 \end{cases}$
- 7.** (a) Sketch the graphs of $f(x) = |x - 2|$ and $g(x) = |x + 2|$ on the same set of axes. Hence, sketch the graph of $y = f(x) + g(x)$.
 (b) Find $\{x : |x - 2| + |x + 2| = k\}$ where
 i. $k = 2$ ii. $k = 4$ iii. $k = 8$
- 8.** On the same set of axes, sketch the graphs of $f(x) = 2|x|$ and $g(x) = |3 - x|$. Hence, find $\{x : f(x) \geq g(x)\}$.

5.3.3 THE EXPONENTIAL FUNCTION

The **exponential function** takes the form $f(x) = a^x, x \in \mathbb{R}, a > 0, a \neq 1$, where the independent variable is the exponent.

Graphs with $a > 1$

An example of an exponential function is $f(x) = 2^x, x \in \mathbb{R}$. So, how does the graph of $f(x) = 2^x$ compare to that of $f(x) = x^2$?

We know that the graph of $f(x) = x^2$ represents a parabola with its vertex at the origin, and is symmetrical about the y -axis. To determine the properties of the exponential function we set up a table of values and use these values to sketch a graph of $f(x) = 2^x$.

x	-3	-2	-1	0	1	2	3	4	5
$y = x^2$	9	4	1	0	1	4	9	16	25
$y = 2^x$	2^{-3}	2^{-2}	2^{-1}	2^0	2^1	2^2	2^3	2^4	2^5
	$= \frac{1}{8}$	$= \frac{1}{4}$	$= \frac{1}{2}$	$= 1$	$= 2$	$= 4$	$= 8$	$= 16$	$= 32$

MATHEMATICS – Higher Level (Core)

We can now plot both graphs on the same set of axes and compare their properties:

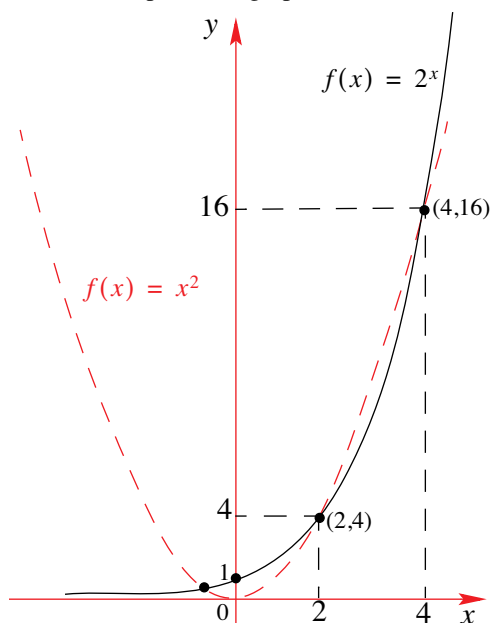

Properties of $f(x) = 2^x$

1. The function increases for all values of x (i.e., as x increases so too do the values of y).
2. The function is always positive (i.e., it lies above the x -axis).
3. As $x \rightarrow \infty$ then $y \rightarrow \infty$
 $x \rightarrow -\infty$ then $y \rightarrow 0$.
 i.e., the x -axis is an asymptote.
4. When
 - i. $x > 0$ then $y > 1$,
 - ii. $x = 0$ then $y = 1$
 - iii. $x < 0$ then $0 < y < 1$.

Notice how different the graphs of the two functions are, even though their rules appear similar. The difference being that for the quadratic function, the variable x is the base, whereas for the exponential, the variable x is the power.

We can now investigate the exponential function for different bases. Consider the exponential functions $f(x) = 3^x$ and $g(x) = 4^x$:

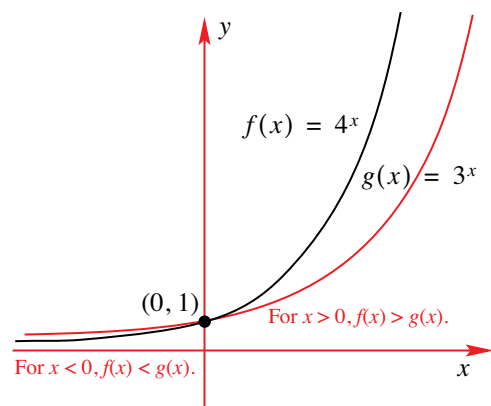

From the graphs we can see that $f(x) = 4^x$ increases much faster than $g(x) = 3^x$ for $x > 0$. For example, at $x = 1$, $f(1) = 4$, $g(1) = 3$ and then, at $x = 2$, $f(2) = 16$, $g(2) = 9$.

However, for $x < 0$ we have the opposite, $f(x) = 4^x$ decreases faster than $g(x) = 3^x$.

Notice then that at $x = 0$, both graphs pass through the point $(0, 1)$.

From the graphs we can see that for values of x less than zero, the graph of $f(x) = 4^x$ lies below that of $f(x) = 3^x$. Whereas for values of x greater than zero, then the graph of $f(x) = 4^x$ lies above that of $f(x) = 3^x$.

Exponential functions that display these properties are referred to as **exponential growth** functions.

What happens when $0 < a < 1$?

We make use of the TI-83 to investigate such cases. Consider the case where $a = \frac{1}{2}$.

Rather than using a table of values we provide a sketch of the curve. The graph shows that the function is decreasing – such exponential functions are referred to as **exponential decay**. In fact, from the second screen we can see that the graph of $y = \left(\frac{1}{2}\right)^x$ is a reflection of $y = 2^x$ about the y -axis.

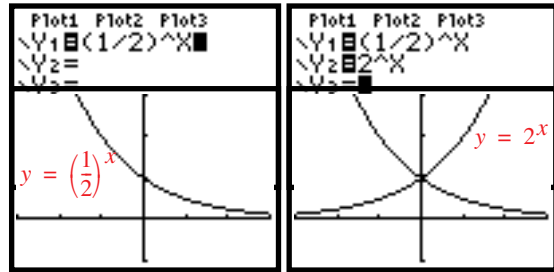

We note that the function $y = \left(\frac{1}{2}\right)^x$ can also be written as $y = (2^{-1})^x = 2^{-x}$. Meaning that

there are two ways to represent an **exponential decay** function, either as $f(x) = a^x, 0 < a < 1$ or $f(x) = a^{-x}, a > 1$. For example, the functions $f(x) = \left(\frac{1}{4}\right)^x$ and $g(x) = 4^{-x}$ are identical.

We can summarise the exponential function as follows:

$$x \mapsto a^x, a > 1, x \in \mathbb{R}$$

(e.g., $f(x) = 2^x, f(x) = 3^x$)

Properties

- Domain** : $\mathbb{R} = (-\infty, \infty)$
- Range** : $\mathbb{R}^+ = (0, \infty)$
- Asymptote** : $y = 0$ (or x -axis)
- Intercepts** : Cuts y -axis at $(0,1)$
- Other** : Increases [**growth**]
Continuous

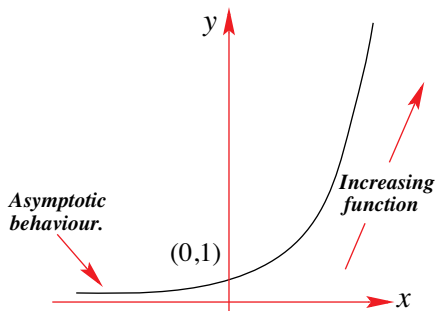

$$x \mapsto a^x, 0 < a < 1, x \in \mathbb{R}$$

(e.g., $f(x) = \left(\frac{1}{2}\right)^x, f(x) = \left(\frac{1}{3}\right)^x$)

Properties

- Domain** : $\mathbb{R} = (-\infty, \infty)$
- Range** : $\mathbb{R}^+ = (0, \infty)$
- Asymptote** : $y = 0$ (or x -axis)
- Intercepts** : Cuts y -axis at $(0,1)$
- Other** : Decreases [**decay**]
Continuous

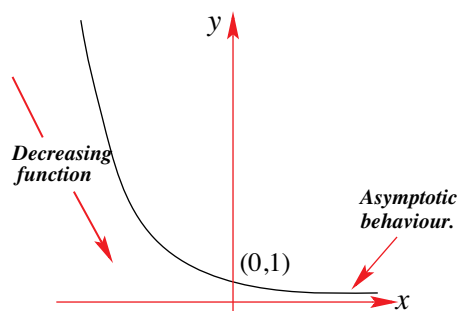

There also exists an important exponential function known as the **natural exponential function**. This function is such that the base has the special number 'e'. The number 'e', which we will consider in more detail in Chapter 7 has a value that is given by the expression

$$e = \lim_{n \rightarrow \infty} \left(1 + \frac{1}{n}\right)^n \approx 2.71828\dots$$

MATHEMATICS – Higher Level (Core)

However, at this stage it suffices to realise that the number ‘ e ’ is greater than one. This means that a function of the form $f(x) = e^x$ will have the same properties as that of $f(x) = a^x$ for $a > 1$. That is, it will depict an exponential growth. Whereas the function $f(x) = e^{-x}$ will depict an exponential decay.

In Chapter 6 we will look at transformations of functions and consider terms such as ‘stretching’, ‘translations’, ‘dilations’ and so on – terms that are applicable to the examples we are about to examine. However, at this stage, we will consider sketching exponential curves from first principles only (and make general observations).

EXAMPLE 5.21

On the same set of axes sketch the following.

(a) $f(x) = 2^x, g(x) = 2^{x-1}$ (b) $f(x) = 3^x, g(x) = 3^{x+2}$

S
o
l
u
t
i
o
n

(a) Making use of the TI-83 we have:

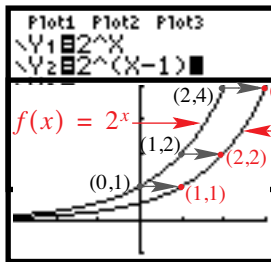
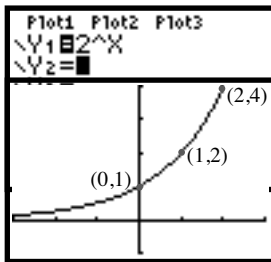

Observations:

The graph of $g(x)$ is the graph of $f(x)$ moved (i.e., translated) one unit to the right.

(b)

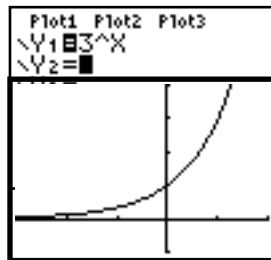

Notice that we had to change the window settings to see both graphs on the same screen.

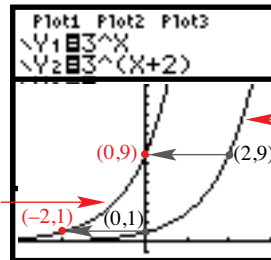

Observations:

The graph of $g(x)$ is the graph of $f(x)$ moved (i.e., translated) two units to the left.

From our observations we can make the following generalisation about the graph of $y = a^{x \pm k}$.

1. The graph of $y = a^{x-k}, k > 0$ is identical to $y = a^x$ but moved ‘ k ’ units to the right.
2. The graph of $y = a^{x+k}, k > 0$ is identical to $y = a^x$ but moved ‘ k ’ units to the left.

Because of the extremities between the large and small values encountered with exponential functions, sketching these graphs to scale is often difficult. When sketching exponential functions, it is important to include the main features of the graph – for example, make sure that the intercepts and asymptotes are clearly labelled and then provide the general shape of the curve.

EXAMPLE 5.22

On the same set of axes sketch the following.

- (a) $f(x) = 2^x, g(x) = 2^x - 1$ (b) $f(x) = 3^x, g(x) = 3^x + 2$

S
o
l
u
t
i
o
n

(a)

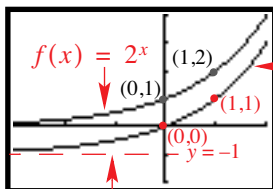
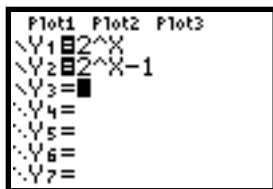

Observations:

The graph of $g(x)$ is the graph of $f(x)$ moved (i.e., translated) one unit down. Notice too that the asymptote has also moved down one unit, from $y = 0$ to $y = -1$.

(b)

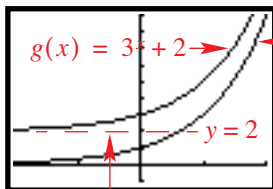
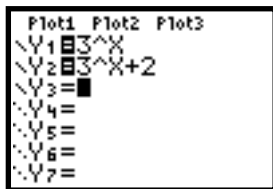

Observations:

The graph of $g(x)$ is the graph of $f(x)$ moved (i.e., translated) two units up. Notice too that the asymptote has also moved up two units, from $y = 0$ to $y = 2$.

From our observations we can make the following generalisation about the graph of $y = a^x \pm k$.

1. The graph of $y = a^x - k, k > 0$ is identical to $y = a^x$ but moved ' k ' units down.
2. The graph of $y = a^x + k, k > 0$ is identical to $y = a^x$ but moved ' k ' units up.

EXAMPLE 5.23

On the same set of axes sketch the following.

- (a) $f(x) = 2^x, g(x) = 3 \times 2^x$ (b) $f(x) = 3^x, g(x) = -\left(\frac{1}{2}\right) \times 3^x$

S
o
l
u
t
i
o
n

(a)

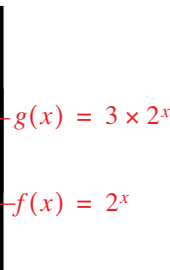
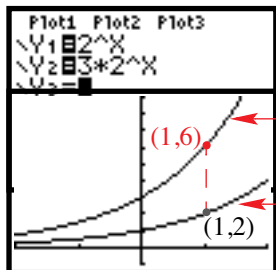

Observations:

The graph of $g(x)$ is the graph of $f(x)$ stretched by a factor of 3 along the y -axis. Notice too that the asymptote has not changed.

(b)

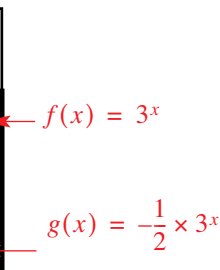
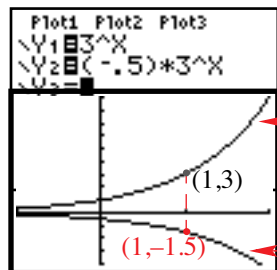

Observations:

The graph of $g(x)$ is the graph of $f(x)$ shrunk by a factor of 2 along the y -axis and reflected about the x -axis. Notice too that the asymptote has not changed.

MATHEMATICS – Higher Level (Core)

From our observations we can make the following generalisation about the graph of $y = k \times a^x$.

1. The graph of $y = k \times a^x, k > 0$ is identical to $y = a^x$ but
 - i. Stretched along the y -axis if $k > 1$.
 - ii. Shrunk along the y -axis if $0 < k < 1$.
2. The graph of $y = k \times a^x, k < 0$ is identical to $y = a^x$ but
 - i. Reflected about the x -axis and stretched along the y -axis if $k < -1$.
 - ii. Reflected about the x -axis and shrunk along the y -axis if $-1 < k < 0$.

Obviously we can use a combination of these ‘effects’ on the basic exponential function:

EXAMPLE 5.24

Sketch the following.

(a) $f(x) = 2 \times e^x - 2$

(b) $f(x) = \frac{1}{2}e^{2x-1}$

Solution Notice that in both cases the general shape of the exponential growth remains unaltered. Only the main features of the graph are of interest when sketching is involved.

(a)

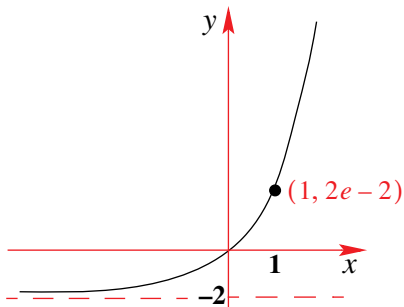

When $x = 0, f(0) = 2 \times e^0 - 2 = 0$.

When $x = 1, f(1) = 2 \times e^1 - 2$.

(b)

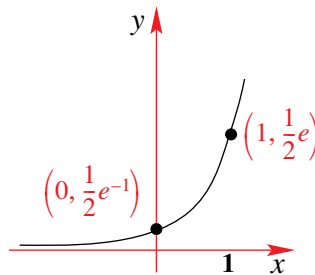

When $x = 0, f(0) = \frac{1}{2}e^{0-1} = \frac{1}{2}e^{-1}$.

When $x = 1, f(1) = \frac{1}{2}e^{2-1} = \frac{1}{2}e^1$.

EXERCISES 5.3.3

1. On separate sets of axes sketch the graphs of the following functions and determine the range of each function.

(a) $f(x) = 4^x$

(b) $f(x) = 3^x$

(c) $f(x) = 5^x$

(d) $f(x) = (2.5)^x$

(e) $f(x) = (3.2)^x$

(f) $f(x) = (1.8)^x$

(g) $f(x) = \left(\frac{1}{2}\right)^x$

(h) $f(x) = \left(\frac{1}{3}\right)^x$

(i) $f(x) = \left(\frac{1}{5}\right)^x$

(j) $f(x) = \left(\frac{3}{4}\right)^x$

(k) $f(x) = \left(\frac{5}{8}\right)^x$

(l) $f(x) = (0.7)^x$

- 2.** Sketch the following on the same set of axes, clearly labelling the y -intercept.
- (a) $f(x) = 3^x + c$ where i. $c = 1$ ii. $c = -2$
 (b) $f(x) = 2^{-x} + c$ where i. $c = 0.5$ ii. $c = -0.5$
- 3.** Sketch the following on the same set of axes, clearly labelling the y -intercept.
- (a) $f(x) = b \times 3^x$ where i. $b = 2$ ii. $b = -2$
 (b) $f(x) = b \times \left(\frac{1}{2}\right)^x$ where i. $b = 3$ ii. $b = -2$
- 4.** On the same set of axes, sketch the following graphs
- (a) $f(x) = 3^x$ and $f(x) = 3^{-x}$ (b) $f(x) = 5^x$ and $f(x) = 5^{-x}$
 (c) $f(x) = 10^x$ and $f(x) = 10^{-x}$ (d) $f(x) = \left(\frac{1}{3}\right)^x$ and $f(x) = \left(\frac{1}{3}\right)^{-x}$
- 5.** Find the range of the following functions:
- (a) $f: [0, 4] \mapsto \mathbb{R}, y = 2^x$ (b) $f: [1, 3] \mapsto \mathbb{R}, y = 3^x$
 (c) $f: [-1, 2] \mapsto \mathbb{R}, y = 4^x$ (d) $f: [-1, 2] \mapsto \mathbb{R}, y = 2^x$
 (e) $f: [2, 3] \mapsto \mathbb{R}, y = 2^{-x}$ (f) $f: [-1, 1] \mapsto \mathbb{R}, y = 10^{-x}$
- 6.** Sketch the graphs of the following functions, stating their range.
- (a) $f: \mathbb{R} \mapsto \mathbb{R}$, where $f(x) = 2e^x + 1$ (b) $f: \mathbb{R} \mapsto \mathbb{R}$, where $f(x) = 3 - e^{x-1}$
 (c) $f: \mathbb{R} \mapsto \mathbb{R}$, where $f(x) = e - e^{-x}$ (d) $f: \mathbb{R} \mapsto \mathbb{R}$, where $f(x) = 2 + \frac{1}{2}e^{-x}$
- 7.** (a) Solve for x , if $x^2 - 4x - 5 = 0$.
 (b) On the same set of axes, sketch the graphs of $f(x) = 5 \times 5^{-x}$ and $g(x) = 5^x - 4$.
 (c) Find i. $\{(x, y) : f(x) = g(x)\}$.
 ii. $\{x : f(x) > g(x)\}$.
- 8.** Find the range of the following functions
- (a) $f:]0, \infty[\mapsto \mathbb{R}$, where $f(x) = e^{-(x+1)} + 2$.
 (b) $g(x) = -2 \times e^x + 1, x \in]-\infty, 0]$.
 (c) $x \mapsto xe^{-x} + 1, x \in [-1, 1]$.
- 9.** (a) Sketch the graph of $f(x) = |2^x - 1|$, clearly labelling all intercepts with the axes and the equation of the asymptote.
 (b) Solve for x , where $|2^x - 1| = 3$.
- 10.** Sketch the graphs of the following functions
- (a) $f(x) = |1 - 2^x|$ (b) $g(x) = |4^x - 2|$ (c) $h(x) = 1 - |2^x|$
- 11.** Sketch the graphs of the following functions
- (a) $f(x) = 1 - 2^{-|x|}$ (b) $g(x) = -4 + 2^{|x|}$ (c) $h(x) = |3^{-|x|} - 3|$

MATHEMATICS – Higher Level (Core)

12. Sketch the graphs of the following functions and find their range.

$$(a) \quad f(x) = \begin{cases} 2^x, & x < 1 \\ 3, & x \geq 1 \end{cases} \quad (b) \quad f(x) = \begin{cases} 3 - e^x, & x > 0 \\ x + 3, & x \leq 0 \end{cases}$$

$$(c) \quad f(x) = \begin{cases} \frac{2}{x+1}, & x \geq 1 \\ 3 - 2^{2-x}, & x < 1 \end{cases} \quad (d) \quad g(x) = \begin{cases} 4 - 3^{-|x|}, & -1 < x < 1 \\ 4 - \frac{1}{3}|x|, & 1 \leq |x| \leq 12 \end{cases}$$

13. Sketch the graphs of the following, and hence state the range in each case.

$$(a) \quad f: \mathbb{R} \rightarrow \mathbb{R}, y = 2^x + \left(\frac{1}{2}\right)^x \quad (b) \quad f: \mathbb{R} \rightarrow \mathbb{R}, y = 3^x + \left(\frac{1}{3}\right)^x$$

$$(c) \quad f: \mathbb{R} \rightarrow \mathbb{R}, y = 2^x - \left(\frac{1}{2}\right)^x \quad (d) \quad f: \mathbb{R} \rightarrow \mathbb{R}, y = \left|2^x - \left(\frac{1}{2}\right)^x\right|$$

14. Sketch the graph of the functions

$$(a) \quad g(x) = 2^{(x-a)}, a > 0 \quad (b) \quad h(x) = 2^x - a, 0 < a < 1$$

$$(c) \quad f(x) = 2 \times a^x - 2a, a > 1 \quad (d) \quad f(x) = 2 \times a^x - 2a, 0 < a < 1$$

$$(e) \quad g(x) = a - a^x, a > 1 \quad (f) \quad h(x) = -a + a^{-x}, a > 1$$

15. (a) On the same set of axes, sketch $f(x) = 2 \times a^x$ and $g(x) = 4 \times a^{-x}$ where $a > 1$.

Hence, sketch the graph of the function $h(x) = a^x + 2a^{-x}$, where $a > 1$.

(b) On the same set of axes, sketch $f(x) = x - a$ and $g(x) = a^{x+1}$, where $a > 1$.

Hence, deduce the graph of $h(x) = (x - a) \times a^{x+1}$, where $a > 1$.

16. Sketch the graph of the following functions and determine their range.

$$(a) \quad f(x) = a^{-x^2}, a > 1 \quad (b) \quad f(x) = a^{-x^2}, 0 < a < 1$$

$$(c) \quad g(x) = (a - 1)^{-x}, a > 1 \quad (d) \quad h(x) = 2 - a^{-|x|}, a > 1$$

$$(e) \quad f(x) = \frac{2}{a^x - 1}, a > 1 \quad (f) \quad g(x) = |a^{x^2} - a|, a > 1$$

5.3.4 THE LOGARITHMIC FUNCTION

The logarithmic function, with base ‘ a ’ is represented by the expression $f(x) = \log_a x, x > 0$.

To determine the shape of its graph we start by constructing a table of values for the function

$f(x) = \log_2 x$ and comparing it with the table of values for $g(x) = 2^x$:

x	$\frac{1}{8}$	$\frac{1}{4}$	$\frac{1}{2}$	0	1	2	4	8	16
$y = \log_2 x$	-3	-2	-1	-	0	1	2	3	4
x	-3	-2	-1		0	1	2	3	4
$y = 2^x$	$\frac{1}{8}$	$\frac{1}{4}$	$\frac{1}{2}$		1	2	4	8	16

From the table of values we observe that the x and y values have interchanged! Plotting these results on the same set of axes, we observe that the graph of the logarithmic function is a reflection of the exponential function about the line $y = x$. So, whereas for the exponential function, the asymptote is the x -axis (i.e., $y = 0$), for the logarithmic function, the asymptote is the y -axis (i.e., $x = 0$).

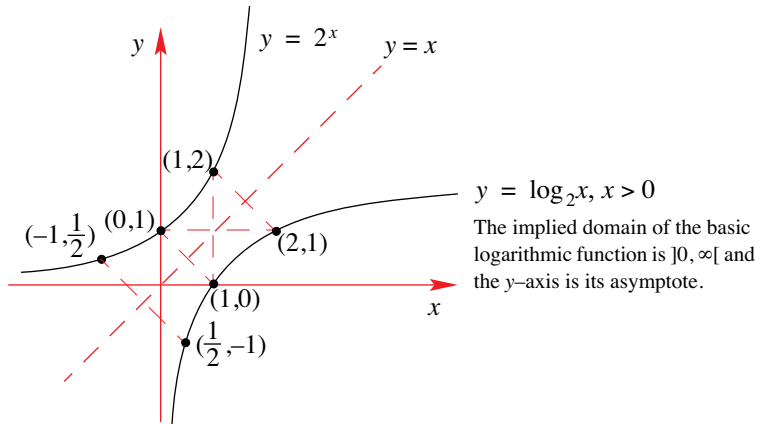

So, how do the graphs of $y = \log_e x$, $y = \log_{10} x$, $y = \log_3 x$ compare to $y = \log_2 x$. The best way to see this is to sketch the graphs on the same set of axes:

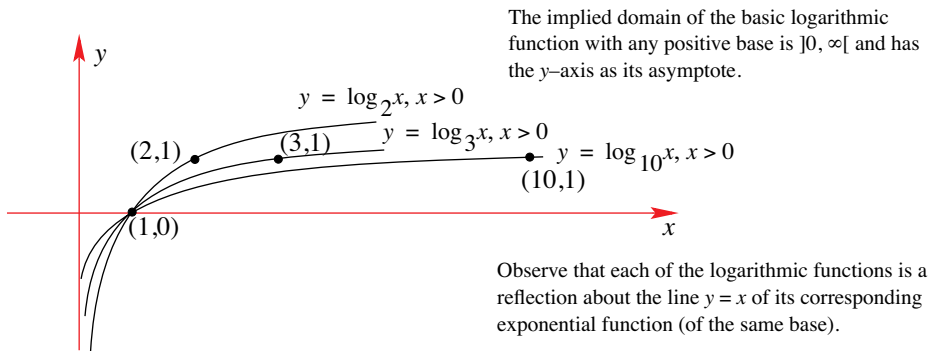

Notice that for all $a > 0$ $\log_a 1 = 0$ and $\log_a a = 1$.

As is the case for the exponential functions, the base ‘ e ’ also plays an important role when dealing with logarithmic functions. When using the number ‘ e ’ as the base for the logarithmic function, we refer to it as the **natural logarithmic function** and can write it in one of two ways:

$$f(x) = \log_e x, x > 0 \text{ or } f(x) = \ln x, x > 0$$

EXAMPLE 5.25

Sketch the following, specifying the implied domain in each case.

- (a) $f(x) = \log_3(x - 2)$ (b) $g(x) = \log_2(2x + 3)$

S
o
l
u
t
i
o
n

- (a) We begin by looking at the domain: As we cannot have the logarithm of a negative number we must have that $x - 2 > 0 \Leftrightarrow x > 2$.
Therefore, domain of $f =]2, \infty[$.
Note also then, that by default we have obtained the equation of the vertical asymptote, in this case it is $x = 2$.
When $x = 3$, $f(3) = \log_3 1 = 0$ and
when $x = 5$, $f(5) = \log_3 3 = 1$.

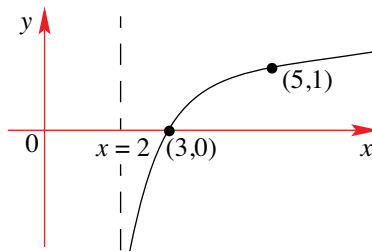

- (b) This time we need to have $2x + 3 > 0 \Leftrightarrow x > -\frac{3}{2}$.
Therefore, the implied domain of $g = (-\frac{3}{2}, \infty)$.
The vertical asymptote has the equation $x = -\frac{3}{2}$.
When $x = -1$, $g(-1) = \log_2(-2 + 3) = \log_2 1 = 0$.
When $x = 0$, $g(0) = \log_2(0 + 3) = \log_2 3$.

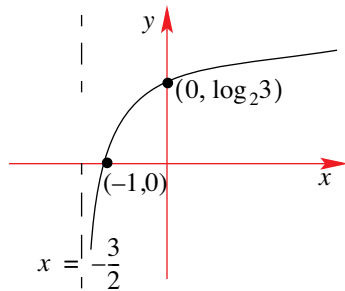

We make the following general observations:

1. The graph of $y = \log_a(x - k)$, $k > 0$ is identical to $y = \log_a x$ but moved ' k ' units to the right and has a vertical asymptote at $x = k$.
2. The graph of $y = \log_a(x + k)$, $k > 0$ is identical to $y = \log_a x$ but moved ' k ' units to the left and has a vertical asymptote at $x = -k$.

Notice that in part (b) of example 5.25, we have $g(x) = \log_2(2x + 3) = \log_2 2(x + \frac{3}{2})$, where we can still 'see' the equation of the asymptote as $x = -\frac{3}{2}$. The extra factor of '2' can be viewed as either a dilation or a translation – we will leave further discussion of this to Chapters 6 and 7.

EXAMPLE 5.26

Sketch the following, specifying the implied domain in each case.

- (a) $f(x) = -2\log_3 x$ (b) $f(x) = \frac{1}{3}\log_e x$

S
o
l
u
t
i
o
n

- (a) The implied domain in this case is $x > 0$.
So, the vertical asymptote has the equation $x = 0$.
We note that the negative sign in front of the $\log_3 x$ will have the effect of reversing the sign of the $\log_3 x$ values.
That is, the graph of $f(x) = -\log_3 x$ is a reflection about the x -axis of the graph of $y = \log_3 x$.

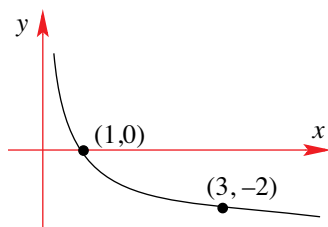

The factor of 2 will have the effect of ‘stretching’ the graph of $y = \log_3 x$ by a factor of 2 along the y -axis.

Also, we have that $f(1) = -2\log_3 1 = 0$ and $f(3) = -2\log_3 3 = -2$.

- (b) This time the implied domain is $]0, \infty[$.
Therefore, the equation of the asymptote is $x = 0$. The one third factor in front of $\log_e x$ will have the effect of ‘shrinking’ the graph of $y = \log_e x$ by a factor of 3.

Then, $f(1) = \frac{1}{3}\log_e 1 = 0$ and $f(e) = \frac{1}{3}\log_e e = \frac{1}{3}$.

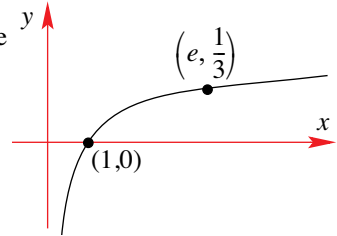

Again, we have the following observations:

1. The graph of $y = k \times \log_a x, k > 0$ is identical to $y = \log_a x$ but
 - i. Stretched along the y -axis if $k > 1$.
 - ii. Shrunk along the y -axis if $0 < k < 1$.
2. The graph of $y = k \times \log_a x, k < 0$ is identical to $y = \log_a x$ but
 - i. Reflected about the x -axis and stretched along the y -axis if $k < -1$.
 - ii. Reflected about the x -axis and shrunk along the y -axis if $-1 < k < 0$.

EXAMPLE 5.27

Sketch the following, specifying the implied domain in each case.

- (a) $g(x) = \log_2 x + 3$ (b) $g(x) = \log_2 x - 2$ (c) $g(x) = \log_2(3 - x)$

Solution

- (a) The effect of adding 3 to the graph of $y = \log_2 x$ will result in $g(x) = \log_2 x + 3$ being moved up 3 units.
Its implied domain is $]0, \infty[$ and its asymptote has equation $x = 0$.

- (b) The effect of subtracting 2 from the graph of $y = \log_2 x$ will result in $g(x) = \log_2 x - 2$ being moved down 2 units.
Its implied domain is $]0, \infty[$ and its asymptote has equation $x = 0$.

- (c) As we cannot have the logarithm of a negative number we must have that $3 - x > 0 \Leftrightarrow x < 3$. This means that the vertical asymptote is given by $x = 3$ and the graph must be drawn to the left of the asymptote.

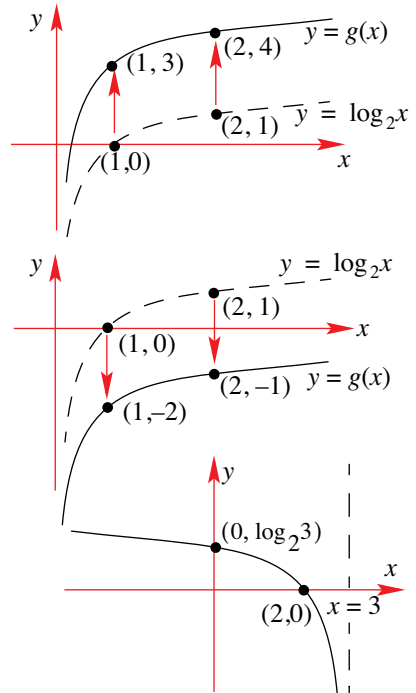

We make the following general observations:

1. The graph of $y = \log_a x - k$, $k > 0$ is identical to $y = \log_a x$ but moved ‘ k ’ units vertically down and has a vertical asymptote at $x = 0$.
2. The graph of $y = \log_a x + k$, $k > 0$ is identical to $y = \log_a x$ but moved ‘ k ’ units vertically up and has a vertical asymptote at $x = 0$.

1. The graph of $y = \log_a(-x)$ is identical to $y = \log_a x$ but reflected about the y -axis and has a vertical asymptote at $x = 0$.
2. The graph of $y = \log_a(k - x)$, $k > 0$ is identical to $y = \log_a x$ but reflected about the y -axis, moved ‘ k ’ units to the right and has a vertical asymptote at $x = k$.

EXERCISES 5.3.4

- 1.** Sketch the graph of the following functions, clearly stating domains and labelling asymptotes.

- | | |
|-----------------------------|------------------------------|
| (a) $f(x) = \log_4(x - 2)$ | (b) $f(x) = \log_2(x + 3)$ |
| (c) $h(x) = \log_{10}x + 2$ | (d) $g(x) = -3 + \log_3x$ |
| (e) $f(x) = \log_5(2x - 1)$ | (f) $h(x) = \log_2(2 - x)$ |
| (g) $g(x) = 2\log_{10}x$ | (h) $f(x) = -\log_{10}x + 1$ |

- 2.** Sketch the graph of the following functions, clearly stating domains and labelling asymptotes.

- | | |
|---------------------------------|---|
| (a) $f(x) = 2\log_2x + 3$ | (b) $f(x) = 10 - 2\log_{10}x$ |
| (c) $h(x) = 2\log_22(x - 1)$ | (d) $g(x) = -\frac{1}{2}\log_{10}(1 - x)$ |
| (e) $f(x) = \log_2(3x + 2) - 1$ | (f) $h(x) = 3\log_2\left(\frac{1}{2}x - 1\right) + 1$ |

- 3.** Sketch the graph of the following functions, clearly stating domains and labelling asymptotes.

- | | | |
|--------------------------|------------------------|-------------------------|
| (a) $f(x) = 2\ln x$ | (b) $g(x) = -5\ln x$ | (c) $f(x) = \ln(x - e)$ |
| (d) $f(x) = \ln(1 - ex)$ | (e) $f(x) = 5 - \ln x$ | (f) $h(x) = \ln x - e$ |

- 4.** Sketch the graph of the following functions, clearly stating domains and labelling asymptotes.

- | | | |
|--|---------------------------|------------------------------|
| (a) $f(x) = \log_2\sqrt{x}$ | (b) $f(x) = \log_{10}x^2$ | (c) $h(x) = \ln x $ |
| (d) $g(x) = \ln\left(\frac{1}{x}\right)$ | (e) $h(x) = \ln(1 - x^2)$ | (f) $f(x) = \log_2(x^2 - 4)$ |

- 5.** Sketch the graph of the following functions, clearly stating domains and labelling asymptotes.
- (a) $f(x) = |\log_{10}x|$ (b) $g(x) = |\log_2(x-1)|$ (c) $h(x) = |\ln x - 1|$
 (d) $h(x) = 2 - |\ln x|$ (e) $f(x) = \log_2|x+2|$ (f) $f(x) = \log_5\left|\frac{1}{x}\right|$
- 6.** Given the function $y = f(x)$, sketch the graph of
- i. $y = |f(x)|$ ii. $y = f(|x|)$
- (a) $f(x) = \log_{10}(-x)$ (b) $f(x) = \ln\left(\frac{1}{x} - e\right)$
 (c) $f(x) = 2 - \ln(ex - 1)$ (d) $f(x) = \log_2(x^2 - 2x)$
- 7.** (a) On the same set of axes, sketch the graphs of $f(x) = \ln x - 1$ and $g(x) = \ln(x - e)$.
 (b) Find $\{x : \ln x > \ln(x - e) + 1\}$.
- 8.** Sketch the graph of the following functions and find their range.
- (a) $f(x) = \begin{cases} \log_{10}x, & x \geq 1 \\ 1 - x, & x < 1 \end{cases}$ (b) $f(x) = \begin{cases} \log_2(x^2 - 1), & |x| \geq 1 \\ 1 - x^2, & |x| < 1 \end{cases}$
 (c) $f(x) = \begin{cases} 2 - \ln x, & x \geq e \\ \frac{x^3}{e^{3^x}}, & x < e \end{cases}$ (d) $g(x) = \begin{cases} 1 + \sqrt{x-1}, & x > 1 \\ |\log_2x| + 1, & 0 < x \leq 1 \\ 1, & x \leq 0 \end{cases}$
- 9.** Sketch the graph of the following functions.
- (a) $f(x) = \log_{\frac{1}{2}}x$ (b) $f(x) = \log_{\frac{1}{2}}(x-2)$ (c) $f(x) = \log_{\frac{1}{3}}x + 1$
- 10.** Sketch the graph of the following functions, clearly stating domains and labelling asymptotes.
- (a) $f(x) = 2\log_a(x-a), a > 1$ (b) $f(x) = -\ln(ax-e), a > e$
 (c) $g(x) = |\log_{10}(10-ax)|, 1 < a < 10$ (d) $g(x) = \ln|x-ae|, a > 1$
 (e) $g(x) = |\ln|x-ae||, a > 1$ (f) $h(x) = \log_a\left(1 - \frac{x}{a}\right), 0 < a < 1$
- 11.** Sketch the graph of $f(x) = \frac{1}{a}\log_a(ax-1), 0 < a < 1$ clearly labelling its asymptote, and intercept(s) with the axes. Hence, find $\left\{x : f(x) > \frac{1}{a}\right\}$.
- 12.** Sketch the graph of (a) $f(x) = \frac{\ln x}{x}, x > 0$ (b) $g(x) = \frac{x}{\ln x}, x > 0$
 Given that $f(x) \leq e^{-1}$ for all real $x > 0$, state the range of $g(x)$.

5.3.5 EQUATIONS OF THE FORM $y = x^n, n = -1, -2$

Case 1: $n = -1$

With $n = -1$ we have the equation $y = x^{-1} = \frac{1}{x}, x \neq 0$ – this graph has a shape known as a **rectangular hyperbola**.

Making use of the TI-83 we make the following observations:

1. The sign of y is the same as the sign of x .
2. As x increases, values of y decrease.
3. The function is **undefined** at $x = 0$.
At $x = 0$ there exists a **vertical asymptote**.
4. The graph never crosses (or touches) the x -axis.
The x -axis then becomes a **horizontal asymptote**, having the equation $y = 0$.

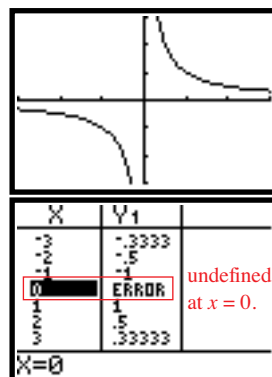

We now formalise some of these observations and introduce some new mathematical terms.

We first consider the interval $x > 0$:

1. As x **tends** to (i.e., approaches) **positive infinity**, the values of y **tend** to (i.e., approach) **zero from above**. i.e., As $x \rightarrow +\infty, y \rightarrow 0^+$.
2. As x **tends** to (i.e., approaches) **zero from above**, the values of y **tend** to (i.e., approach) **positive infinity**. i.e., As $x \rightarrow 0^+, y \rightarrow +\infty$.

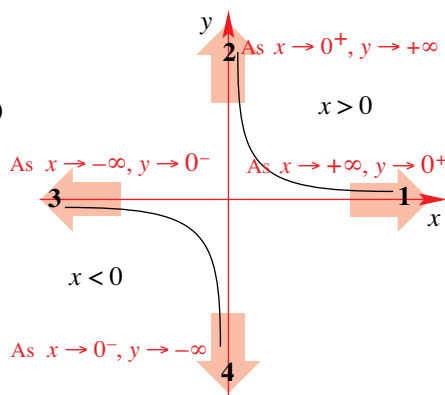

Next we consider the interval $x < 0$:

3. As x **tends** to (i.e., approaches) **negative infinity**, the values of y **tend** to (i.e., approach) **zero from below**. i.e., As $x \rightarrow -\infty, y \rightarrow 0^-$.
4. As x **tends** to (i.e., approaches) **zero from below**, the values of y **tend** to (i.e., approach) **negative infinity**. i.e., As $x \rightarrow 0^-, y \rightarrow -\infty$.

The expression ‘*approaching zero from above*’ means that a variable is approaching the value zero, but the values are always greater than zero. e.g., the sequence $0.1, 0.001, 0.0001, \dots$ approaches zero from above (as the values are always greater than zero).

The expression ‘*approaching zero from below*’ means that a variable is approaching the value zero, but the values are always less than zero. e.g., the sequence $-0.1, -0.001, -0.0001, \dots$ approaches zero from below (as the values are always less than zero).

As was the case for the exponential and logarithmic functions, the horizontal and vertical asymptotes of the basic function $f(x) = \frac{1}{x}, x \neq 0$ can also be ‘relocated’. We summarise these results now:

1. The graph of $y = \frac{1}{x-k}, k > 0$ is identical to $y = \frac{1}{x}$ but moved ‘ k ’ units to the right and so has a vertical asymptote at $x = k$.
2. The graph of $y = \frac{1}{x+k}, k > 0$ is identical to $y = \frac{1}{x}$ but moved ‘ k ’ units to the left and so has a vertical asymptote at $x = -k$.

1. The graph of $y = \frac{1}{x} + k, k > 0$ is identical to $y = \frac{1}{x}$ but moved ‘ k ’ units up and so has a horizontal asymptote at $y = k$.
2. The graph of $y = \frac{1}{x} - k, k > 0$ is identical to $y = \frac{1}{x}$ but moved ‘ k ’ units down and so has a horizontal asymptote at $y = -k$.

Case 2: $n = -2$

With $n = -2$ we have the equation $y = x^{-2} = \frac{1}{x^2}, x \neq 0$ – this graph has a shape known as a **truncus**.

The reason for its name becomes obvious once we sketch its graph – it looks like the trunk of a tree. As before, we can make use of a table of values and plot its graph, however, this time we list the properties of this function and its graph:

1. Function is **undefined** at $x = 0$.
2. Asymptotes are: vertical, $x = 0$
horizontal, $y = 0$
3. The graph is symmetrical about the y -axis.

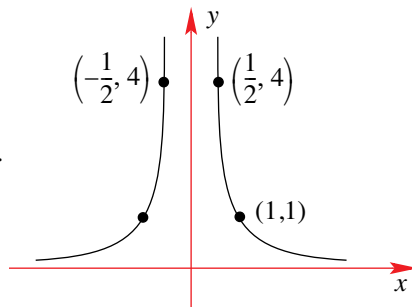

We can also make the following observations:

1. The graph of $y = \frac{1}{(x-k)^2}, k > 0$ is identical to $y = \frac{1}{x^2}$ but moved ‘ k ’ units to the right and so has a vertical asymptote at $x = k$.
2. The graph of $y = \frac{1}{(x+k)^2}, k > 0$ is identical to $y = \frac{1}{x^2}$ but moved ‘ k ’ units to the left and so has a vertical asymptote at $x = -k$.

- The graph of $y = \frac{1}{x^2} + k, k > 0$ is identical to $y = \frac{1}{x^2}$ but moved ‘ k ’ units up and so has a horizontal asymptote at $y = k$.
- The graph of $y = \frac{1}{x^2} - k, k > 0$ is identical to $y = \frac{1}{x^2}$ but moved ‘ k ’ units down and so has a horizontal asymptote at $y = -k$.

EXAMPLE 5.28

Sketch the following, specifying the implied domain in each case.

- (a) $f(x) = \frac{1}{x} + 1$ (b) $g(x) = \frac{1}{(x+1)^2}$ (c) $h(x) = \frac{1}{x-1} - 2$

S
o
l
u
t
i
o
n

- (a) $d_f =]-\infty, \infty[\setminus\{0\}$ (b) $d_g =]-\infty, \infty[\setminus\{-1\}$ (c) $d_h =]-\infty, \infty[\setminus\{1\}$

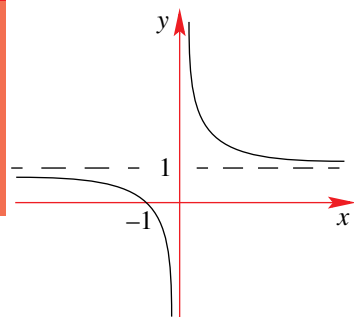

Asymptotes: vertical, $x = 0$
horizontal, $y = 1$

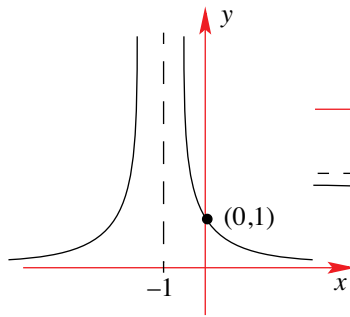

Asymptotes: vertical, $x = -1$
horizontal, $y = 0$

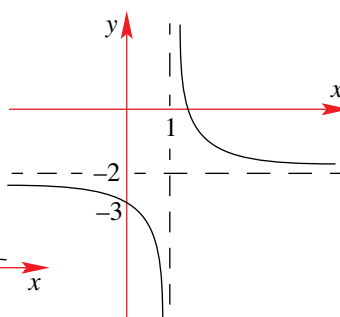

Asymptotes: vertical, $x = 1$
horizontal, $y = -2$

EXAMPLE 5.29

Sketch the following, specifying the implied domain in each case.

- (a) $f(x) = 2 - \frac{2}{x}$ (b) $g(x) = -\frac{1}{2x^2} + 2$

S
o
l
u
t
i
o
n

- (a) The effect of the ‘2’ in the $\frac{2}{x}$ term is to stretch the graph of $y = \frac{1}{x}$ along the y -axis by a factor of 2. The ‘-ve’ in front of the $\frac{2}{x}$ term will reflect the the graph of $y = \frac{2}{x}$ about the x -axis. Adding ‘2’ to the graph of $y = -\frac{2}{x}$ will move the graph up ‘2’ units.

The domain of this function is given by $]-\infty, \infty[\setminus\{0\}$ and it has two asymptotes. The vertical asymptote is at $x = 0$ and the horizontal asymptote is at $y = 2$.

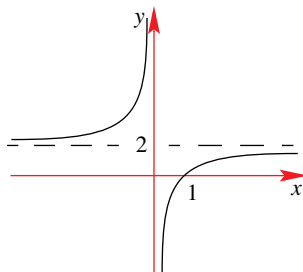

To find the x -intercept, set $y = 0$:

$$y = 0 \Leftrightarrow 2 - \frac{2}{x} = 0 \Leftrightarrow 2 = \frac{2}{x} \Leftrightarrow x = 1$$

- (b) Using the same argument as in part (a), except this time the original graph of $y = \frac{1}{x^2}$ is ‘shrunk’ by a factor of ‘2’ (or stretched by a factor of 0.5) along the y -axis, reflected about the x -axis, and moved up ‘2’ units, we have:

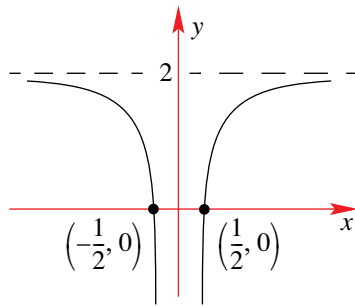

To find the x -intercept, set $y = 0$:

$$\begin{aligned} y = 0 &\Leftrightarrow -\frac{1}{2x^2} + 2 = 0 \Leftrightarrow \frac{1}{2x^2} = 2 \\ &\Leftrightarrow x^2 = \frac{1}{4} \\ &\Leftrightarrow x = \pm\frac{1}{2} \end{aligned}$$

EXERCISES 5.3.5

1. Sketch the graphs of the following functions, clearly identifying the equations of all asymptotes and intercepts with the axes.

(a) $f(x) = \frac{1}{x+2}, x \neq -2$

(b) $g(x) = \frac{2}{x-2}, x \neq 2$

(c) $f(x) = 3 + \frac{1}{x}, x \neq 0$

(d) $h(x) = 2 - \frac{3}{x}, x \neq 0$

(e) $f(x) = \frac{4}{3-x}, x \neq 3$

(f) $f(x) = \frac{3}{2(x-1)}, x \neq 1$

(g) $g(x) = \frac{1}{2} - \frac{2}{x+1}, x \neq -1$

(h) $f(x) = \frac{6}{2+x} - 3, x \neq -2$

2. Sketch the graphs of the following functions, clearly identifying the equations of all asymptotes and intercepts with the axes.

(a) $g(x) = \frac{2}{x^2} + 1, x \neq 0$

(b) $f(x) = -\frac{4}{(x+1)^2}, x \neq -1$

(c) $f(x) = 4 - \frac{16}{x^2}, x \neq 0$

(d) $g(x) = -2 + \frac{4}{(x-1)^2}, x \neq 1$

3. Given that $\frac{2x+3}{x+1} = a + \frac{b}{x+1}$, find a and b . Hence sketch the graph of $f: x \mapsto \left| \frac{2x+3}{x+1} \right|$.

4. For the given function, f , sketch the graph of i. $y = |f(x)|$ ii. $y = f(|x|)$

(a) $f(x) = \frac{1}{x} - 1$

(b) $f(x) = \frac{2}{2-x} + 1$

(c) $f(x) = 2 - \frac{1}{x+1}$

(d) $f(x) = \frac{4}{(2-x)^2}$

(e) $f(x) = 2 - \frac{1}{2x^2}$

(f) $f(x) = \frac{2}{(1+x)^2}$

5.4 ALGEBRA OF FUNCTIONS

5.4.1 BASIC OPERATIONS AND COMPOSITE FUNCTIONS

For any two real functions $f: d_f \mapsto \mathbb{R}, y = f(x)$ and $g: d_g \mapsto \mathbb{R}, y = g(x)$, defined over domains d_f and d_g respectively, the following rules of algebra apply:

Operation	Rule and Domain	Example
Addition	<p>rule: $(f + g)(x) = f(x) + g(x)$</p> <p>domain: $d_{f+g} = d_f \cap d_g$</p>	<p>For $f: [0, \infty) \mapsto \mathbb{R}, f(x) = \sqrt{x}$ and $g: \mathbb{R} \mapsto \mathbb{R}, g(x) = x$, we have: $d_{f+g} = d_f \cap d_g = [0, \infty) \cap \mathbb{R}$ $= [0, \infty)$ $\therefore f + g: [0, \infty) \mapsto \mathbb{R}, (f + g)(x) = \sqrt{x} + x$.</p>
Subtraction	<p>rule: $(f - g)(x) = f(x) - g(x)$</p> <p>domain: $d_{f-g} = d_f \cap d_g$</p>	<p>The process is the same as that for $(f + g)(x)$. Using the same functions as those above, we have: $\therefore f - g: [0, \infty) \mapsto \mathbb{R}, (f - g)(x) = \sqrt{x} - x$.</p>
Multiplication	<p>rule: $(f \times g)(x) = f(x) \times g(x)$ or $(fg)(x) = f(x)g(x)$</p> <p>domain: $d_{f \times g} = d_f \cap d_g$ or $d_{fg} = d_f \cap d_g$</p>	<p>If $f(x) = \frac{2}{x-1}$, where $x \in \mathbb{R} \setminus \{1\}$ and $g(x) = 1 - x^2$, where $x \in [0, \infty)$, we have: $d_{f \times g} = d_f \cap d_g$ $= \mathbb{R} \setminus \{1\} \cap [0, \infty)$ $= [0, \infty) \setminus \{1\}$ $\therefore (f \times g)(x) = \frac{2}{x-1} \times (1 - x^2) = -2(1 + x)$ That is, $(fg)(x) = -2(1 + x)$, where $x \in [0, \infty) \setminus \{1\}$</p>
Division	<p>rule: $\left(\frac{f}{g}\right)(x) = \frac{f(x)}{g(x)}, g(x) \neq 0$</p> <p>domain: $d_{\frac{f}{g}} = d_f \cap d_g \setminus \{x: g(x) = 0\}$</p>	<p>If $f: \mathbb{R} \mapsto \mathbb{R}, f(x) = x^2$ and $g: \mathbb{R} \mapsto \mathbb{R}, g(x) = x + 1$, we have: domain $d_{\frac{f}{g}} = d_f \cap d_g \setminus \{x: g(x) = 0\}$ $= \mathbb{R} \cap \mathbb{R} \setminus \{x: x + 1 = 0\}$ $= \mathbb{R} \setminus \{-1\}$ $\therefore \left(\frac{f}{g}\right)(x) = \frac{x^2}{x+1}, x \in \mathbb{R} \setminus \{-1\}$</p>

COMPOSITE FUNCTIONS

We now investigate another way in which we can combine functions, namely **composition**.

Consider the two functions $f(x) = 3x$ and $g(x) = x^2 + 1$. Observe what happens to the value $x = 2$ as we first apply the function $f(x)$ and then the function $g(x)$ to the image of the first mapping, i.e.,

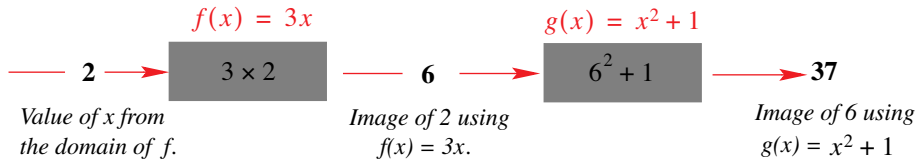

Such a combination of functions leads to the question

“Is there a third function that will enable us to produce the same result in one step?”

We consider any value x that belongs to the domain of f and follow ‘its path’:

1. This value of x , has as its image the value $f(x) = 3x$.
2. The resulting number, $3x$, now represents an element of the domain of g .
3. The image of $3x$ under the mapping g is given by $g(3x) = (3x)^2 + 1 = 9x^2 + 1$.

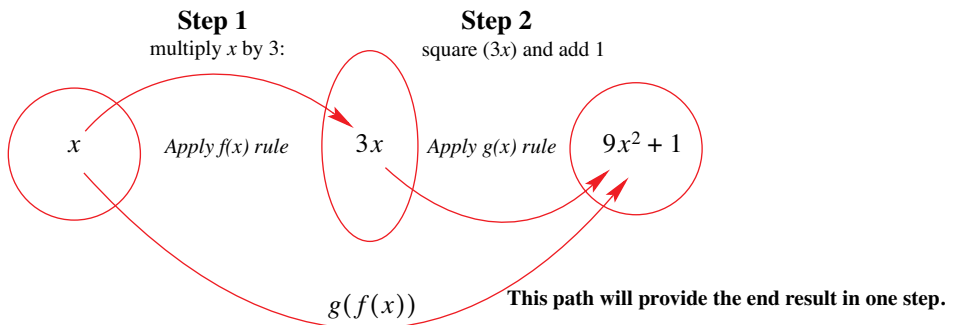

We can now test our result by using the value of $x = 2$ with the mapping $x \mapsto 9x^2 + 1$.

For $x = 2$, we have $9(2)^2 + 1 = 9 \times 4 + 1 = 37$, which agrees with our previous result.

The two **critical steps** in this process are:

1. That the image under the first mapping must belong to the domain of the second mapping.
2. The expression $g(f(x))$ exists.

Notation

The expression $g(f(x))$ is called the composite function of f and g and is denoted by $g \circ f$.

(Notice that although f is applied first, it is placed second in the expression $g \circ f$.)

EXAMPLE 5.30

Given the functions $f(x) = x^2 + 1$ and $g(x) = \ln(x - 1)$, find the composite function $(g \circ f)(x)$.

S
o
l
u
t
i
o
n

The composite function $(g \circ f)(x) = g(f(x))$

$$= \ln(f(x) - 1)$$

$$= \ln(x^2 + 1 - 1)$$

$$= \ln x^2$$

In Example 5.30 we have $(g \circ f)(-1) = \ln(-1)^2 = \ln 1 = 0$ and $(g \circ f)(2) = \ln 2^2 = \ln 4$.

EXAMPLE 5.31

Given the functions $f(x) = 2 - x$ and $g(x) = \sqrt{x - 1}$, find the composite function $(g \circ f)(x)$.

S
o
l
u
t
i
o
n

The composite function $(g \circ f)(x) = g(f(x))$

$$= \sqrt{f(x) - 1}$$

$$= \sqrt{(2 - x) - 1}$$

$$= \sqrt{1 - x}$$

In Example 5.31 we have $(g \circ f)(-1) = \sqrt{1 - (-1)} = \sqrt{2}$ but $(g \circ f)(2) = \sqrt{1 - 2} = \sqrt{-1}$ is undefined! So what went wrong? To answer this question let's take another look at the composition process.

The process is made up of two stages:

- Stage 1:** An element from the domain of the first function, $f(x)$ is used to produce an image. That is, using $x = a$ we produce the image $f(a)$.
- Stage 2:** Using the second function, $g(x)$, the image, $f(a)$, is used to produce a second image $g(f(a))$.

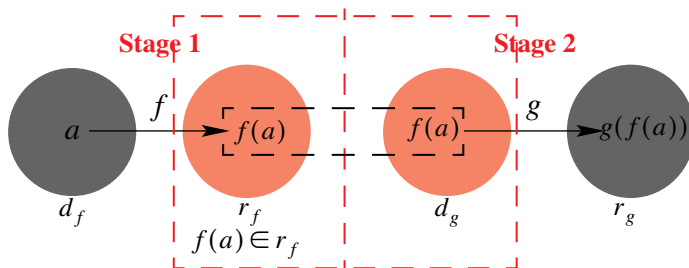

From the diagram, the result of stage 1 is $f(a)$ (which belongs to the range of f) we also observe that at stage 2, when using the value $f(a)$ (produced from stage 1) we have assumed that $f(a)$ belongs to the domain of $g(x)$. This is where problems can arise – as seen in Example 5.31.

To overcome this difficulty we need to strengthen our definition of composition of functions as well as ensuring the existence of composite functions.

What we need to prove is that all values produced from stage 1, i.e., $f(a)$, are values in the domain of the function in stage 2, i.e., $f(a) \in d_g$. Making use of a mapping diagram, we show the inter-relation between the range of f , r_f , and the domain of g , d_g .

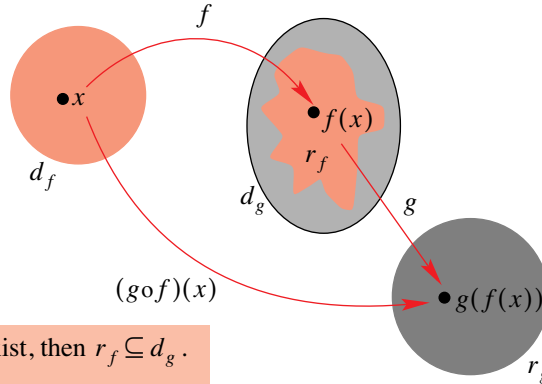

For $(g \circ f)(x) = g(f(x))$ to exist, then $r_f \subseteq d_g$.

What is the domain of $g \circ f$?

If we refer to the diagram alongside, we see that

$$\text{if } r_f \subseteq d_g, \text{ then } d_{g \circ f} = d_f.$$

This means that we can substitute values of x that belong to the domain of f directly into the expression $g(f(x))$ (once we have established that it exists).

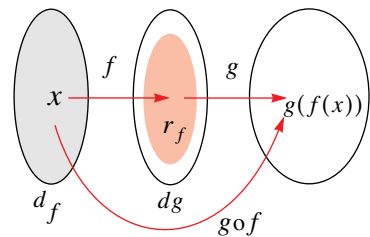

EXAMPLE 5.32

If $f(x) = \sqrt{x+1}$, $x \in (0, \infty)$ and $g(x) = x^3$, $x \in \mathbb{R}$, determine if $g \circ f$ exists, and find an expression for $g \circ f$ if it does.

S
o
l
u
t
i
n

For $g \circ f$ to exist we must have that $r_f \subseteq d_g$.

Using the TI-83 we obtain the range of f from its sketch, in this case, $r_f = (1, \infty)$.

The domain of g is $(-\infty, \infty)$ (i.e., the real field).

Then, given that $(1, \infty) \subseteq (-\infty, \infty)$, $g \circ f$ does exist.

We are now able to determine $g \circ f$.

$$\begin{aligned} \text{First we determine the equation } g(f(x)): g(f(x)) &= g(\sqrt{x+1}) \\ &= (\sqrt{x+1})^3 \\ &= (x+1)^{3/2}. \end{aligned}$$

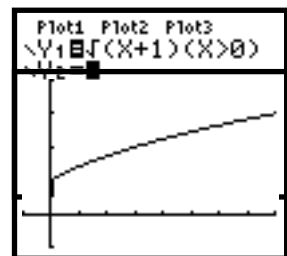

Next we need the domain of $g \circ f$. As we have seen, $d_{g \circ f} = d_f$, $\therefore d_{g \circ f} = (0, \infty)$.

Therefore, $g \circ f: (0, \infty) \rightarrow \mathbb{R}$, $(g \circ f)(x) = (x+1)^{3/2}$.

Hint on setting out

When solving problems that involve the use of composition, it is useful to set up a **domain–range table** in order to help us determine the existence of the composition. Such a table includes information about the domain and range of both the functions under consideration:

	domain	range
f	d_f	r_f
g	d_g	r_g

The existence of $g \circ f$ can then be established by looking at r_f and d_g . Similarly, the existence of $f \circ g$ can be established by comparing r_g and d_f .

EXAMPLE 5.33

Find $g \circ f$ and its range, given that $g(x) = \frac{1}{x+1}, x \in \mathbb{R} \setminus \{-1\}$ and

$$f(x) = 2^x, x \in \mathbb{R}.$$

SOLUTION

We first sketch the graphs of both functions to help us complete the domain–range table:

$$g(x) = \frac{1}{x+1}, x \in \mathbb{R} \setminus \{-1\}, \quad f(x) = 2^x, x \in \mathbb{R}.$$

We now complete the table:

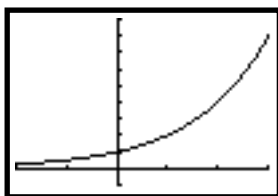
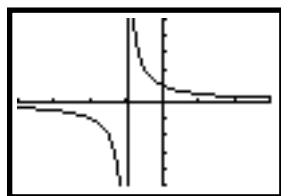

	domain	range
f	\mathbb{R}	$]0, \infty[$
g	$\mathbb{R} \setminus \{-1\}$	$\mathbb{R} \setminus \{0\}$

Using the table we see that $r_f \subseteq d_g \Rightarrow g \circ f$ exists.

$$\text{We can now determine } g \circ f : g(f(x)) = \frac{1}{f(x)+1} = \frac{1}{2^x+1}.$$

We also have that $d_{g \circ f} = d_f, \therefore d_{g \circ f} = \mathbb{R}$.

$$\text{Therefore, } g \circ f : \mathbb{R} \rightarrow \mathbb{R}, \text{ where } (g \circ f)(x) = \frac{1}{2^x+1}.$$

Making use of the TI-83 we see that the range of $g \circ f$ is $]0, 1[$.

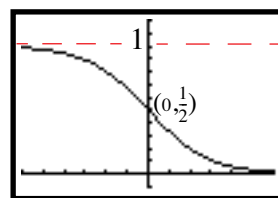

EXAMPLE 5.34

Given that $f(x) = \sqrt{x-1}$ and $g(x) = \ln x$. Does $f \circ g$ exist? If so, define fully the function $f \circ g$. If not, find a suitable restriction on the domain of g so that $f \circ g$ exists.

SOLUTION

For $f \circ g$ to exist it is necessary that $r_g \subseteq d_f$. To determine the range of g we need to know the domain of g . Using the implied domain we have that $d_g =]0, \infty[$ and so, $r_g = \mathbb{R}$.

However, the implied domain of f is $[1, \infty[$. Then, as $r_g \not\subseteq d_f, f \circ g$ does not exist.

In order that $f \circ g$ exists we need to have $r_g \subseteq [1, \infty[$, i.e., we must have that $g(x) \geq 1$. What

remains then, is to find those values of x such that $g(x) \geq 1$.

Now, $g(x) = \ln x$ therefore, $g(x) \geq 1 \Leftrightarrow \ln x \geq 1 \Leftrightarrow x \geq e$.

So, if the domain of g is restricted to $[e, \infty[$ or any subset of $[e, \infty[$, then $f \circ g$ will exist.

Does $g \circ f = f \circ g$?

In general the answer is **no**! However, there exist situations when $(f \circ g)(x) = (g \circ f)(x)$ – we will look at such cases in the next section.

Consider Example 5.33, where $g(x) = \frac{1}{x+1}$, $x \in \mathbb{R} \setminus \{-1\}$ and $f(x) = 2^x$, $x \in \mathbb{R}$.

From our previous working, we have that $(g \circ f)(x) = \frac{1}{2^x + 1}$.

To determine if $(f \circ g)(x)$ exists, we will need to determine if $r_g \subseteq d_f$. Using the domain–range table we have that $r_g = \mathbb{R} \setminus \{0\}$ and $d_f = \mathbb{R}$. Therefore as $r_g \subseteq d_f \Rightarrow f \circ g$ does exist.

We then have, $(f \circ g)(x) = f(g(x)) = 2^{g(x)} = 2^{\frac{1}{x+1}}$.

To determine the domain of $f \circ g$, we use the fact that, $d_{f \circ g} = d_g$ so that $d_{f \circ g} = \mathbb{R} \setminus \{-1\}$.

Then, $f \circ g: \mathbb{R} \setminus \{-1\} \mapsto \mathbb{R}$, where $(f \circ g)(x) = 2^{\frac{1}{x+1}}$.

Clearly then, in this case, $(f \circ g)(x) \neq (g \circ f)(x)$.

EXAMPLE 5.35

Given $f(x) = x^2 + 1$, where $x \geq 0$ and $g(x) = x - 1$, where $x \geq 1$, determine the functions $(f \circ g)(x)$ and $(g \circ f)(x)$ (if they exist). For the composite functions that exist, find the image of $x = 3$.

S
o
l
u
t
i
o
n

We first set up the domain–range table:

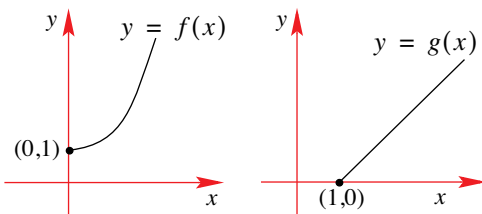

	domain	range
f	$[0, \infty[$	$[1, \infty[$
g	$[1, \infty[$	$[0, \infty[$

From the table we see that $r_g \subseteq d_f$ and $r_f \subseteq d_g$, and so, both $(f \circ g)(x)$ and $(g \circ f)(x)$ exist. We can now determine both composite functions.

We start with $(f \circ g)(x)$:

$$(f \circ g)(x) = f(g(x)) = (g(x))^2 + 1 = (x - 1)^2 + 1$$

MATHEMATICS – Higher Level (Core)

As $d_{f \circ g} = d_g = [1, \infty[$, we have that $(f \circ g)(x) = (x - 1)^2 + 1$, where $x \geq 1$.

Next, we find $(g \circ f)(x)$:

$$\begin{aligned}(g \circ f)(x) &= g(f(x)) = f(x) - 1 = (x^2 + 1) - 1 \\ &= x^2\end{aligned}$$

Similarly, $d_{g \circ f} = d_f = [0, \infty[$, and so, $(g \circ f)(x) = x^2$, where $x \geq 0$.

To find the image of 3, we substitute $x = 3$ into the final equations.

$(f \circ g)(3) = (3 - 1)^2 + 1 = 2^2 + 1 = 5$, whereas, $(g \circ f)(3) = (3)^2 = 9$.

EXERCISES 5.4.1

- 1.** Fully define the functions (a) $f + g$ (b) fg

given that i. $f(x) = x^2$ and $g(x) = \sqrt{x}$

ii. $f(x) = \ln x$ and $g(x) = \frac{1}{x}$

iii. $f(x) = \sqrt{9 - x^2}$ and $g(x) = \sqrt{x^2 - 4}$

Find the range for case (a).

- 2.** Fully define the functions (a) $f - g$ (b) f/g

given that i. $f(x) = e^x$ and $g(x) = 1 - e^x$

ii. $f(x) = x + 1$ and $g(x) = \sqrt{x + 1}$

iii. $f(x) = |x - 2|$ and $g(x) = |x + 2|$

Find the range for case (a).

- 3.** All of the following functions are mappings of $\mathbb{R} \rightarrow \mathbb{R}$ unless otherwise stated.

(a) Determine the composite functions $(f \circ g)(x)$ and $(g \circ f)(x)$, if they exist.

(b) For the composite functions in (a) that do exist, find their range.

i. $f(x) = x + 1, g(x) = x^3$

ii. $f(x) = x^2 + 1, g(x) = \sqrt{x}, x \geq 0$

iii. $f(x) = (x + 2)^2, g(x) = x - 2$

iv. $f(x) = \frac{1}{x}, x \neq 0, g(x) = \frac{1}{x}, x \neq 0$,

v. $f(x) = x^2, g(x) = \sqrt{x}, x \geq 0$

vi. $f(x) = x^2 - 1, g(x) = \frac{1}{x}, x \neq 0$

vii. $f(x) = \frac{1}{x}, x \neq 0, g(x) = \frac{1}{x^2}, x \neq 0$

viii. $f(x) = x - 4, g(x) = |x|$

ix. $f(x) = x^3 - 2, g(x) = |x + 2|$

x. $f(x) = \sqrt{4 - x}, x \leq 4, g(x) = x^2$

xi. $f(x) = \frac{x}{x + 1}, x \neq -1, g(x) = x^2$

xii. $f(x) = x^2 + x + 1, g(x) = |x|$

xiii. $f(x) = 2^x, g(x) = x^2$ xiv. $f(x) = \frac{1}{x+1}, x \neq -1, g(x) = x-1$
 xv. $f(x) = \frac{2}{\sqrt{x-1}}, x > 1, g(x) = x^2 + 1$ xvi. $f(x) = 4^x, g(x) = \sqrt{x}$

- 4.** Given the functions $f: x \mapsto 2x + 1, x \in]-\infty, \infty[$ and $g: x \mapsto x + 1, x \in]-\infty, \infty[$
 Find the functions (a) $(f \circ g)$ (b) $(g \circ f)$ (c) $(f \circ f)$
- 5.** Given that $f: x \mapsto x + 1, x \in \mathbb{R}$ and $g \circ f: x \mapsto x^2 + 2x + 2, x \in \mathbb{R}$, determine the function g .
- 6.** The functions f and g are defined by $f: x \mapsto x + 1, x \in \mathbb{R}$ and $g: x \mapsto x + \frac{1}{x}, x \in \mathbb{R} \setminus \{0\}$.
 Find the composite functions (where they exist) of
 (a) $f \circ g$ (b) $g \circ f$ (c) $g \circ g$ stating the range in each case.
- 7.** If $g: x \mapsto x^3 + 1, x \in \mathbb{R}$ and $f: x \mapsto \sqrt{x}, x \in [0, \infty[$, evaluate (a) $(g \circ f)(4)$
 (b) $(f \circ g)(2)$
- 8.** Given that $f: x \mapsto x + 5, x \in \mathbb{R}$ and $h: x \mapsto x - 7, x \in \mathbb{R}$, show that $(f \circ h)(x)$ is equal to $(h \circ f)(x)$ for all $x \in \mathbb{R}$.
- 9.** Solve the equation $(f \circ g)(x) = 0$, where
 (a) $f: x \mapsto x + 5, x \in \mathbb{R}$ and $g: x \mapsto x^2 - 6, x \in \mathbb{R}$.
 (b) $f: x \mapsto x^2 - 4, x \in \mathbb{R}$ and $g: x \mapsto x + 1, x \in \mathbb{R}$.
- 10.** Given that $f: x \mapsto 2x + 1, x \in \mathbb{R}$ determine the two functions g , given that
 (a) $(g \circ f)(x) = \frac{1}{2x+1}$ (b) $(f \circ g)(x) = \frac{1}{2x+1}$
- 11.** Find $(h \circ f)(x)$, given that $h(x) = \begin{cases} x^2 + 4, & x \geq 1 \\ 4 - x, & x < 1 \end{cases}$ and $f: x \mapsto x - 1, x \in \mathbb{R}$.
 Sketch the graph of $(h \circ f)(x)$ and use it to find its range.
- 12.** (a) Given three functions, f, g and h , when would $h \circ g \circ f$ exist?
 (b) If $f: x \mapsto x + 1, x \in \mathbb{R}$, $g: x \mapsto x^2, x \in \mathbb{R}$ and $h: x \mapsto 4x, x \in \mathbb{R}$, find $(h \circ g \circ f)(x)$.
- 13.** Given the functions $f(x) = e^{2x-1}$ and $g(x) = \frac{1}{2}(\ln x + 1)$ find, where they exist
 (a) $(f \circ g)$ (b) $(g \circ f)$ (c) $(f \circ f)$
 In each case find the range of the composite function.
- 14.** Given that $h(x) = \log_{10}(4x - 1), x > \frac{1}{4}$ and $k(x) = 4x - 1, x \in]-\infty, \infty[$, find, where they exist, (a) $(h \circ k)$ (b) $(k \circ h)$.

MATHEMATICS – Higher Level (Core)

- 15.** Given the functions $f(x) = \sqrt{x^2 - 9}$, $x \in \mathbf{S}$ and $g(x) = |x| - 3$, $x \in \mathbf{T}$, find the largest positive subsets of \mathbb{R} so that (a) $g \circ f$ exists (b) $f \circ g$ exists.

16. For each of the following functions

- (a) determine if $f \circ g$ exists and sketch the graph of $f \circ g$ when it exists.
 (b) determine if $g \circ f$ exists and sketch the graph of $g \circ f$ when it exists.

i.

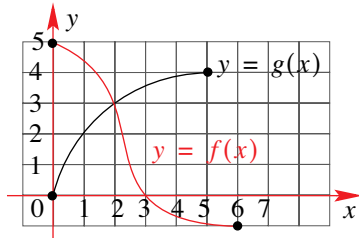

ii.

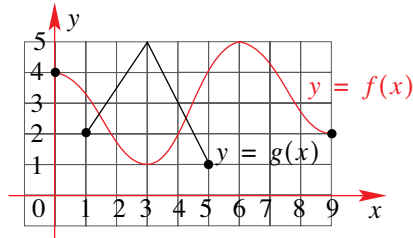

- 17.** Given the functions $f : \mathbf{S} \rightarrow \mathbb{R}$ where $f(x) = e^{x+1}$ and $g : \mathbf{S} \rightarrow \mathbb{R}$ where $g(x) = \ln 2x$ where $\mathbf{S} =]0, \infty[$.

- (a) State the domain and range of both f and g .
 (b) Giving reasons, show that $g \circ f$ exists but $f \circ g$ does not exist.
 (c) Fully define $g \circ f$, sketch its graph and state its range.

- 18.** The functions f and g are given by $f(x) = \begin{cases} \sqrt{x-1} & \text{if } x \geq 1 \\ x-1 & \text{if } 0 < x < 1 \end{cases}$ and $g(x) = x^2 + 1$.

- (a) Show that $f \circ g$ is defined. (b) Find $(f \circ g)(x)$ and determine its range.

- 19.** Let $f : \mathbb{R}^+ \rightarrow \mathbb{R}^+$ where $f(x) = \begin{cases} \frac{1}{x^2}, & 0 < x \leq 1 \\ \frac{1}{\sqrt{x}}, & x > 1 \end{cases}$.

- (a) Sketch the graph of f .
 (b) Define the composition $f \circ f$, justifying its existence.
 (c) Sketch the graph of $f \circ f$, giving its range.

- 20.** Consider the functions $f :]1, \infty[\rightarrow \mathbb{R}$ where $f(x) = \sqrt{x}$ and $g : \mathbb{R} \setminus \{0\} \rightarrow \mathbb{R}$ where $g(x) = x^2$.

- (a) Sketch the graphs of f and g on the same set of axes.
 (b) Prove that $g \circ f$ exists and find its rule.
 (c) Prove that $f \circ g$ cannot exist.
 (d) If a new function $g^* : \mathbf{S} \rightarrow \mathbb{R}$ where $g^*(x) = g(x)$ is now defined, find the largest positive subset of \mathbb{R} so that $f \circ g^*$ does exist. Find $f \circ g^*$, sketch its graph and determine its range.

- 21.** Given that $f(x) = \frac{ax-b}{cx-a}$, show that $f \circ f$ exists and find its rule.

- 22.** (a) Sketch the graphs of $f(x) = \frac{1}{a}x^2$ and $g(x) = \sqrt{2a^2 - x^2}$, where $a > 0$.
 (b) Show that $f \circ g$ exists, find its rule and state its domain.
 (c) Let S be the largest subset of \mathbb{R} so that $g \circ f$ exists.
 i. Find S.
 ii. Fully define $g \circ f$, sketch its graph and find its range.

5.4.2 IDENTITY AND INVERSE FUNCTIONS

Before we start our discussion of inverse functions, it is worthwhile looking back at a fundamental area of algebra – algebraic operations. The relevant algebraic properties for real numbers $a \in \mathbb{R}$, $b \in \mathbb{R}$ and $c \in \mathbb{R}$ are:

	Under addition	Under multiplication
Closure	$a + b \in \mathbb{R}$	$a \times b \in \mathbb{R}$
Commutativity	$a + b = b + a$	$a \times b = b \times a$
Associativity	$(a + b) + c = a + (b + c)$	$(a \times b) \times c = a \times (b \times c)$
Existence of the identity	0 : $a + 0 = 0 + a = a$	1 : $a \times 1 = 1 \times a = a$
Inverse element	$-a$: $a + (-a) = 0 = (-a) + a$	$\frac{1}{a}$: $\left(\frac{1}{a}\right) \times a = 1 = a \times \left(\frac{1}{a}\right)$

Just as there exists an **identity element** for addition, i.e., 0 and for multiplication, i.e., 1 under the real number system, it seems reasonable to assume that an identity element exists when dealing with functions.

It should be noted that without an identity element, equations such as $x + 2 = 7$ and $2x = 10$ could not be solved under the real number system. Because we take the process for solving these equations for granted, sometimes we lose sight of the underpinning algebraic process that led to their solution.

For example, to solve $x + 2 = 7$ we would write $x = 5$ as the next step. However, if we break the process down we have the following:

$$\begin{aligned}
 x + 2 = 7 &\Leftrightarrow x + 2 + (-2) = 7 + (-2) && \text{[Inverse element]} \\
 &\Leftrightarrow x + 0 = 5 && \text{[Identity]} \\
 &\Leftrightarrow x = 5
 \end{aligned}$$

So that without the identity element, we would not be able to make the last statement!

Consider the two functions $f : x \mapsto \mathbb{R}, \sqrt[3]{x}, x \in \mathbb{R}$ and $g : x \mapsto \mathbb{R}, x^3, x \in \mathbb{R}$. The composite functions $f \circ g$ and $g \circ f$ exist. The composite functions are then given by:

$$(f \circ g)(x) = f(g(x)) = \sqrt[3]{g(x)} = \sqrt[3]{x^3} = x.$$

and

$$(g \circ f)(x) = g(f(x)) = (f(x))^3 = (\sqrt[3]{x})^3 = x.$$

For this particular example we have the result that $f(g(x)) = x = g(f(x))$.

MATHEMATICS – Higher Level (Core)

Using an analogy to the algebraic properties for the real number system, we introduce the identity function:

Identity function

We define the identity function, I , as $I(x) = x$

If an identity function, I , exists then it must have the property that for any given function f

$$foI = Iof = f \quad \text{or} \quad (foI)(x) = (Iof)(x) = f(x)$$

As we have already seen, it is found that a function with the rule $I(x) = x$ has the required properties. However, unlike its counterpart in the real number system, where the identities are unique, the domain of the identity function is chosen to match that of the function f .

For example, if $f(x) = \sqrt{x}$, $x \geq 0$ then $I(x) = x$ where $x \geq 0$.

Whereas if $f(x) = 2x$, $x \in]-\infty, \infty [$ then $I(x) = x$ where $x \in]-\infty, \infty [$.

The existence of the identity function leads us to investigate the existence of an **inverse function**.

Inverse function

Using an analogy to the real number system, the concept of an inverse requires that given some function f , there exists an inverse function, f^{-1} , such that

$$fof^{-1} = I = f^{-1}of \quad \text{or} \quad (fof^{-1})(x) = x = (f^{-1}of)(x)$$

The ‘-1’ used in f^{-1} should not be mistaken for an exponent, i.e., $f^{-1}(x) \neq \frac{1}{f(x)}$!

The reciprocal function, $\frac{1}{f(x)}$, can be written in exponent form as $(f(x))^{-1}$. Pay close attention to where the ‘-1’ is positioned. We highlight this difference geometrically:

Consider the function $f(x) = \sqrt{x+1}$. Using the **DRAW** menu on the TI-83 to sketch the graphs of f^{-1} and the reciprocal of f , we immediately see how different the two graphs are.

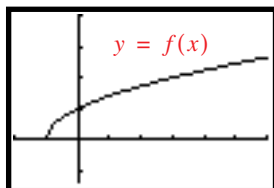

Clearly, the inverse function and the reciprocal function are not the same.

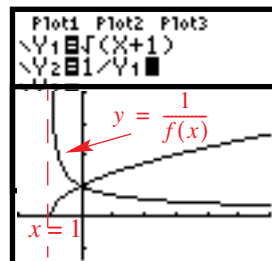
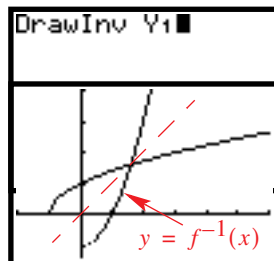

Looking back at the two functions $f : x \mapsto \mathbb{R}, \sqrt[3]{x}, x \in \mathbb{R}$ and $g : x \mapsto \mathbb{R}, x^3, x \in \mathbb{R}$ we notice that the function g is the reverse operation of function f , and function f is the reverse operation of function g . Making use of a mapping diagram we can ‘visualise’ the process:

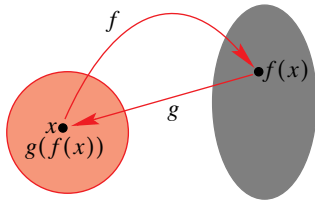

1. Use an element (x) from the domain of the function f and obtain its image $f(x)$.
2. Using this image, which must be an element of the domain of g , we then apply g to $f(x)$ and obtain its image, $g(f(x))$.
Resulting in the value x that we started with.

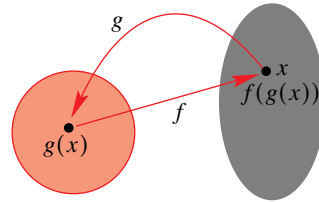

1. Use an element (x) from the domain of the function g and obtain its image $g(x)$.
2. Using this image, which must be an element of the domain of f , we then apply f to $g(x)$ and obtain its image, $f(g(x))$.
Resulting in the value x that we started with.

We can now make some observations:

1. The domain of f , d_f , must equal the range of g , r_g and the domain of g , d_g must equal the range of f , r_f .
2. For the uniqueness of ‘ x ’ to be guaranteed both **f and g must be one-to-one functions.**

We therefore have the result:

If f and g are **one-to-one functions**, such that $f(g(x)) = x = g(f(x))$, then g is known as the inverse of f and f as the inverse of g .

In our case we write, $g(x) = f^{-1}(x)$ and $f(x) = g^{-1}(x)$. This then brings us back to the notation we first introduced for the inverse function. We summarise our findings:

For the inverse function of f , f^{-1} (read as f inverse) to exist, then

1. f must be a one to one function
2. i. the domain of f is equal to the range of f^{-1} , i.e., $d_f = r_{f^{-1}}$.
ii. the range of f is equal to the domain of f^{-1} , i.e., $d_{f^{-1}} = r_f$.
3. $f(f^{-1}(x)) = x = f^{-1}(f(x))$.

How do we find the inverse function?

A guideline for determining the inverse function can be summarised as follows:

- Step 1.** Check that the function under investigation is a one-to-one function. This is best done by using a sketch of the function.
- Step 2.** Use the expression $f(f^{-1}(x)) = x$ to solve for $f^{-1}(x)$.
- Step 3.** Use the fact that $d_{f^{-1}} = r_f$, and $d_f = r_{f^{-1}}$ to complete the problem.

EXAMPLE 5.36

Find the inverse of the function $f: x \mapsto 5x + 2$, where $x \in \mathbb{R}$.

Solution

We start by checking if the function is a one-to-one function.

From the graph, it is clearly the case that $f(x)$ is a one-to-one function.

Making use of the result that $f(f^{-1}(x)) = x$ to solve for $f^{-1}(x)$:

$$f(f^{-1}(x)) = 5f^{-1}(x) + 2$$

$$\text{Then, } f(f^{-1}(x)) = x \Rightarrow 5f^{-1}(x) + 2 = x$$

$$\Leftrightarrow 5f^{-1}(x) = x - 2$$

$$\Leftrightarrow f^{-1}(x) = \frac{1}{5}(x - 2)$$

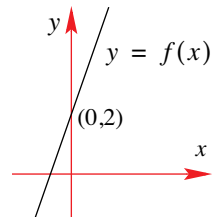

To complete the question we need the domain of f^{-1} . We already know that $d_{f^{-1}} = r_f$, therefore all we now need is the range of f , so $d_{f^{-1}} = \mathbb{R}$ (using the graph of $f(x)$).

That is, $f^{-1}: \mathbb{R} \mapsto \mathbb{R}$ where $f^{-1}(x) = \frac{1}{5}(x - 2)$.

EXAMPLE 5.37

Find the inverse function of $f(x) = \sqrt{x + 2}$, $x \geq -2$ and sketch its graph.

Solution

A quick sketch of the graph of f verifies that it is a one-to-one function.

We can now determine the inverse function, $f^{-1}(x)$:

Now, $f(f^{-1}(x)) = \sqrt{f^{-1}(x) + 2}$, so, using the fact that $f(f^{-1}(x)) = x$

$$\text{we have: } \sqrt{f^{-1}(x) + 2} = x \Leftrightarrow f^{-1}(x) + 2 = x^2 \text{ [After squaring both sides]}$$

$$\Leftrightarrow f^{-1}(x) = x^2 - 2.$$

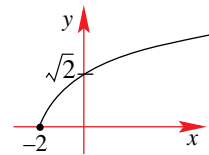

To fully define f^{-1} we need to determine the domain of f^{-1} .

We do this by using the result that $d_{f^{-1}} = r_f$. Using the graph shown above, we have that $r_f = [0, \infty[\therefore d_{f^{-1}} = [0, \infty[$. We are now in a position to fully define the inverse function.

$$\text{We have, } f^{-1}: [0, \infty) \mapsto \mathbb{R}, f^{-1}(x) = x^2 - 2.$$

We can now sketch the graph of the inverse function:

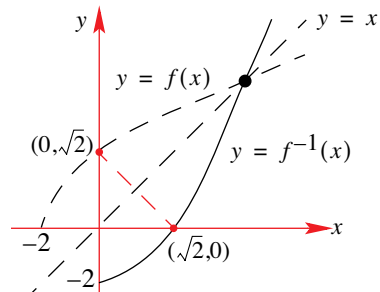

We make two important observations:

1. The graph of $y = f^{-1}(x)$ is the graph of $y = f(x)$ reflected about the line $y = x$.
2. Points of intersection of the graphs $y = f^{-1}(x)$ and $y = f(x)$ will always occur where both curves meet the line $y = x$.

The relationship between the graph of a function f and the graph of its inverse function f^{-1} can be explained rather neatly, because all that has actually happened is that we have interchanged the x - and y - values, i.e., $(a, b) \leftrightarrow (b, a)$. In doing so, we find that $d_{f^{-1}} = r_f$, and $d_f = r_{f^{-1}}$. This then has the result that the graph of the inverse function $f^{-1}(x)$ is a reflection of the graph of the original function $f(x)$ about the line with equation $y = x$.

Graphing the inverse function

The graph of $f^{-1}(x)$ is a reflection of the graph of $f(x)$ about the line $y = x$.

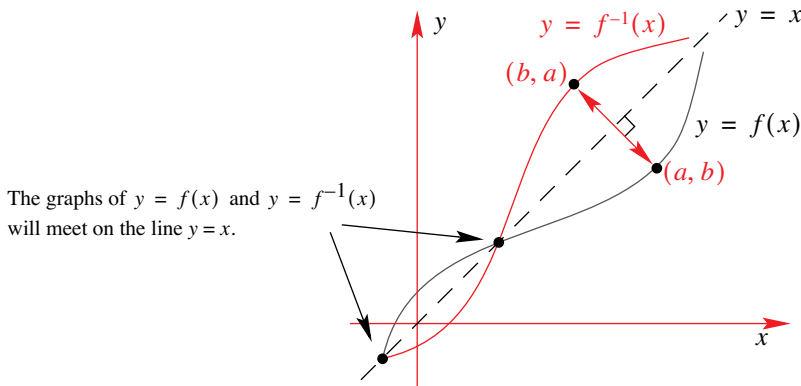

Because of the nature of the functions $f^{-1}(x)$ and $f(x)$, when finding the points of intersection of the two graphs, rather than solving $f^{-1}(x) = f(x)$, it might be easier to solve the equations $f^{-1}(x) = x$ or $f(x) = x$. The only caution when solving the latter two, is to always keep in mind the domain of the original function.

One interesting function is $f(x) = \frac{1}{x}$, $x \neq 0$. It can be established that its inverse function is given by $f^{-1}(x) = \frac{1}{x}$, $x \neq 0$ i.e., $f(f^{-1}(x)) = x \Rightarrow \frac{1}{f^{-1}(x)} = x \Leftrightarrow f^{-1}(x) = \frac{1}{x}$. Then, as the

two functions are identical, it is its **self-inverse**. Sketching the graph of $f(x) = \frac{1}{x}$, $x \neq 0$ and reflecting it about the line $y = x$ will show that the two graphs overlap each other. Note then, that self-inverse functions also intersect at points other than just those on the line $y = x$ – basically because they are the same functions!

MATHEMATICS – Higher Level (Core)

There is a second method that we can use to find the inverse of a function. The steps required are:

- Step 1.** Let y denote the expression $f(x)$.
- Step 2.** Interchange the variables x and y .
- Step 3.** Solve for y .
- Step 4.** The expression in step 3 gives the inverse function, $f^{-1}(x)$.

We work through an example using this method.

EXAMPLE 5.38

Find the inverse function, f^{-1} of $f :]-1, \infty[\mapsto \mathbb{R}$ where $f(x) = \frac{2}{x-1} + 1$ and sketch its graph.

Solution

Let $y = f(x)$, giving $y = \frac{2}{x-1} + 1$.

Next, we interchange the variables x and y : $x = \frac{2}{y-1} + 1$

We now solve for y : $x = \frac{2}{y-1} + 1 \Leftrightarrow x-1 = \frac{2}{y-1}$

$$\Leftrightarrow \frac{1}{x-1} = \frac{y-1}{2} \quad \text{[inverting both sides]}$$

$$\Leftrightarrow y-1 = \frac{2}{x-1}$$

Therefore, we have that $y = \frac{2}{x-1} + 1$

That is, $f^{-1}(x) = \frac{2}{x-1} + 1, x > 1$.

We notice that the original function $y = f(x)$ and its inverse function $y = f^{-1}(x)$ are the same. This becomes obvious when we sketch both graphs on the same set of axes.

When reflected about the line $y = x$, they are identical!

Again, we have an example of a self-inverse function

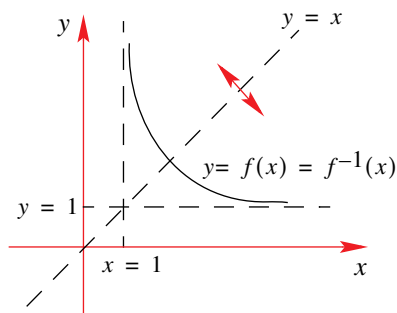

In our work with exponential and logarithmic functions we have already observed the ‘inverse relationship’ that exists between these two functions. That is, we observed that the graph of the curve $y = \log_a x$ was simply the reflection of the graph of $y = a^x$ about the line $y = x$.

When dealing with exponential and logarithmic functions we use the defining relationship between the exponential and logarithmic representation to help us find their inverses.

That is, we use the relationship $N = b^x \Leftrightarrow x = \log_b N$ – when in the form $N = b^x$, x is called the index, whereas when in the form $x = \log_b N$, x is called the logarithm.

We then have:

if $f: x \mapsto \mathbb{R}$ where $f(x) = a^x$

then, $f^{-1}: x \mapsto \mathbb{R}^+$, $f^{-1}(x) = \log_a x$

Similarly,

if $f: x \mapsto \mathbb{R}^+$, $f(x) = \log_a x$

then $f^{-1}: x \mapsto \mathbb{R}$ where $f^{-1}(x) = a^x$

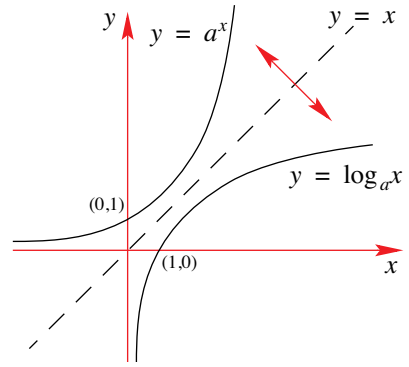

EXAMPLE 5.39

Find the inverse of the function $g: x \mapsto 4^x - 2$, $x \in \mathbb{R}$.

Solution

The function $g: x \mapsto 4^x - 2$, $x \in \mathbb{R}$ is a one-to-one function and so its inverse function exists.

Using the result that $g(g^{-1}(x)) = x$ we have:

$$4^{g^{-1}(x)} - 2 = x$$

$$\Leftrightarrow 4^{g^{-1}(x)} = x + 2$$

$$\therefore g^{-1}(x) = \log_4(x + 2) \text{ [using } N = b^x \Leftrightarrow x = \log_b N \text{]}$$

Now, $d_{g^{-1}} = r_g =]-2, \infty[$ (we have obtained the range by using a sketch of $g(x)$)

Therefore the inverse, g^{-1} , is given by $g^{-1}: x \mapsto \log_4(x + 2)$, $x > -2$

EXAMPLE 5.40

Find the inverse of $g: \left(\frac{1}{2}, \infty\right) \mapsto \mathbb{R}$, $\log_{10}(2x - 1) + 2$.

Solution

This time we make use of the second method of finding the inverse function.

Let $y = \log_{10}(2x - 1) + 2$, interchanging x and y , we have:

$$x = \log_{10}(2y - 1) + 2$$

$$\Leftrightarrow x - 2 = \log_{10}(2y - 1)$$

$$\Leftrightarrow 2y - 1 = 10^{x-2} \text{ [using } N = b^x \Leftrightarrow x = \log_b N \text{]}$$

$$\Leftrightarrow y = \frac{1}{2}(10^{x-2} + 1).$$

Therefore, we have that $f^{-1}(x) = \frac{1}{2}(10^{x-2} + 1)$.

Next, $d_{f^{-1}} = r_f = (-\infty, \infty)$, so the inverse function is $f^{-1}: x \mapsto \frac{1}{2}(10^{x-2} + 1)$, $x \in (-\infty, \infty)$.

EXERCISES 5.4.2

1. Find the inverse function for each of the following.

- (a) $f(x) = 2x + 1, x \in \mathbb{R}$ (b) $f(x) = x^3, x \in \mathbb{R}$
 (c) $g(x) = \frac{1}{3}x - 3, x \in \mathbb{R}$ (d) $g(x) = \frac{2}{5}x + 2, x \in \mathbb{R}$
 (e) $h(x) = \sqrt{x+1}, x > -1$ (f) $f(x) = \sqrt{x+1}, x \geq 0$
 (g) $f(x) = \frac{1}{x+1}, x > -1$ (h) $h(x) = \frac{1}{\sqrt{x}} - 1, x > 0$

2. Using the graph of the original function, sketch the graph of the corresponding inverse function for each part in Question 1.

3. Find and sketch the inverse function of

- (a) $f(x) = x^2 - 3, x \geq 0$. (b) $f(x) = x^2 - 3, x \leq 0$.

4. Show that $f(x) = \frac{x}{\sqrt{x^2 + 1}}, x \in \mathbb{R}$ is a one-to-one function, hence find its inverse, f^{-1} .

5. Sketch the inverse of the following functions:

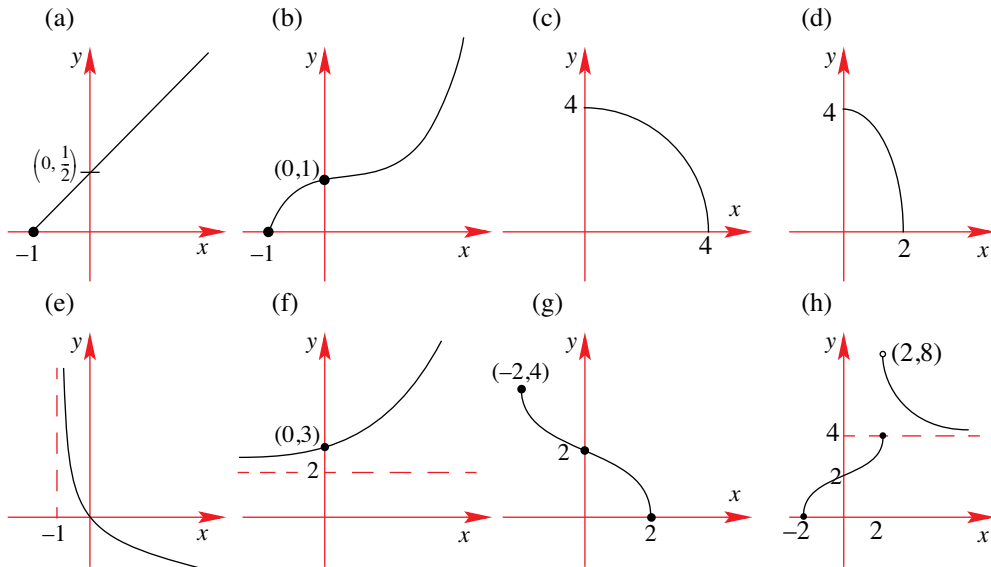

6. Find the inverse function (if it exists) of the following

- (a) $f(x) = 3^x + 1, x \in]-\infty, \infty[$ (b) $f(x) = 2^x - 5, x \in]-\infty, \infty[$
 (c) $f(x) = 3^{2x+1}, x \in]-\infty, \infty[$ (d) $g(x) = 3 - 10^{x-1}, x \in]-\infty, \infty[$
 (e) $h(x) = \frac{2}{3^x - 1}, x \neq 0$ (f) $g(x) = \frac{1}{2^x} - 1, x \in]-\infty, \infty[$

7. Using the graph of the original functions in Question 6, sketch the graph of their inverses.

- 8.** Find the inverse function (if it exists) of the following functions
- (a) $f(x) = \log_2(x+1), x > -1$ (b) $f(x) = \log_{10}(2x), x > 0$
 (c) $h(x) = 1 - \log_2 x, x > 0$ (d) $g(x) = \log_3(x-1) - 1, x > 1$
 (e) $h(x) = 2\log_5(x-5), x > 5$ (f) $f(x) = 2 - \frac{1}{3}\log_{10}(1-x), x < 1$
- 9.** Find the inverse function of $f(x) = x^2 + 2x, x \geq -1$, stating both its domain and range. Sketch the graph of f^{-1} .
- 10.** Find the inverse function of (a) $f(x) = -x + a, x \in]-\infty, \infty[$, where a is real.
 (b) $h(x) = \frac{2}{x-a} + a, x > a$, where a is real.
 (c) $f(x) = \sqrt{a^2 - x^2}, 0 \leq x \leq a$, where a is real.
- 11.** Find the inverse of $h(x) = -x^3 + 2, x \in \mathbb{R}$. Sketch both $h(x)$ and $h^{-1}(x)$ on the same set of axes.
- 12.** Find the largest possible set of positive real numbers S , that will enable the inverse function h^{-1} to exist, given that $h(x) = (x-2)^2, x \in S$.
- 13.** Determine the largest possible positive valued domain, X , so that the inverse function, $f^{-1}(x)$, exists, given that $f(x) = \frac{3x+2}{2x-3}, x \in X$.
- 14.** (a) Sketch the graph of $f(x) = x - \frac{1}{x}, x > 0$. Does the inverse function, f^{-1} exist? Give a reason for your answer.
 (b) Consider the function $g : S \rightarrow \mathbb{R}$ where, $g(x) = x - \frac{1}{x}$. Find the two largest sets S so the the inverse function, g^{-1} , exists. Find both inverses and on separate axes, sketch their graphs.
- 15.** Find f^{-1} given that $f(x) = \sqrt{\frac{x}{a}} - 1$ where $a > 1$. On the same set of axes sketch both the graphs of $y = f(x)$ and $y = f^{-1}(x)$. Find $\{x : f(x) = f^{-1}(x)\}$.
- 16.** Find and sketch the inverse, f^{-1} , of the functions
- (a) $f(x) = \begin{cases} \frac{1}{2}(x+1), & x > 1 \\ -x^3, & x \leq 1 \end{cases}$ (b) $f(x) = \begin{cases} e^{x+1}, & x \leq 0 \\ x + e, & x > 0 \end{cases}$
 (c) $f(x) = \begin{cases} -\ln(x-1), & x > 2 \\ 2-x, & x \leq 2 \end{cases}$ (d) $f(x) = \begin{cases} \sqrt{x} + 4, & x > 0 \\ x + 4, & -4 < x < 0 \end{cases}$

MATHEMATICS – Higher Level (Core)

- 17.** (a) On the same set of axes sketch the graph of $f(x) = \frac{1}{a} \ln(x - a)$, $x > a > 0$ and its reciprocal.
 (b) Find and sketch the graph of f^{-1} .

- 18.** Consider the functions f and g : (a) Does $g \circ f$ exist? Justify your answer.
 (b) Does $(g \circ f)^{-1}$ exist? Justify your answer.
 If it does exist, sketch the graph of $(g \circ f)^{-1}$.

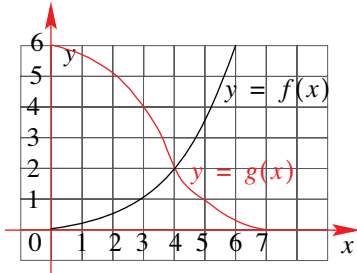

- 19.** (a) On the same set of axes, sketch the graph of $f(x) = -x^3$ and its inverse, $f^{-1}(x)$.

(b) The function g is given $g(x) = \begin{cases} 2x + 1, & x < -1 \\ -x^3, & -1 \leq x \leq 1 \\ 2x - 1, & x > 1 \end{cases}$.

- Sketch the graph of g .
- Fully define its inverse, g^{-1} , stating why it exists.
- Sketch the graph of g^{-1} .
- Find $\{x : g(x) = g^{-1}(x)\}$.

- 20.** Consider the functions $t(x) = e^x$ and $m(x) = \sqrt{x}$.

- (a) Find, where they exist, the composite functions
 i. $(tom)(x)$
 ii. $(mot)(x)$
 (b) With justification, find and sketch the graphs of
 i. $(tom)^{-1}(x)$
 ii. $(mot)^{-1}(x)$
 (c) Find i. $t^{-1} \circ m^{-1}(x)$ ii. $m^{-1} \circ t^{-1}(x)$
 (d) What conclusion(s) can you make from your results of parts (b) and (c)?
 (e) Will your results of part (d) work for any two functions f and g ? Explain.

- 21.** (a) Find $\{x : x^3 + x - 2 = 0\}$.
 (b) If $f(x) = \frac{1}{\sqrt{x}} - 2$, sketch the graph of $y = f(x)$ and find $\{x : f(x) = f^{-1}(x)\}$.

- 22.** Consider the functions $f(x) = |x|$, $x \in \mathbf{A}$ and $g(x) = e^x - 2$, $x \in \mathbf{B}$.

- (a) Sketch the graphs of
 i. f if $\mathbf{A} = \mathbb{R}$
 ii. g if $\mathbf{B} = \mathbb{R}$.
 (b) With \mathbf{A} and \mathbf{B} as given in (a), give reasons why $(f \circ g)^{-1}$ will not exist.
 (c) i. Find the largest set \mathbf{B} which includes positive values, so that $(f \circ g)^{-1}$ exists.
 ii. Fully define $(f \circ g)^{-1}$.
 iii. On the same set of axes, sketch the graphs of $(f \circ g)(x)$ and $(f \circ g)^{-1}(x)$.

6.1 TRANSLATIONS

6.1.1 HORIZONTAL TRANSLATION

A horizontal translation takes on the form $f(x) \rightarrow f(x - a)$.

We start by looking at the transformation of the basic parabolic graph with equation $y = x^2$. The horizontal translation of $y = x^2$ is given by $y = (x - a)^2$. This transformation represents a **translation along the x -axis**.

For example, the graph of $y = (x - 4)^2$ represents the parabola $y = x^2$ translated 4 units to the right ($a = 4$):

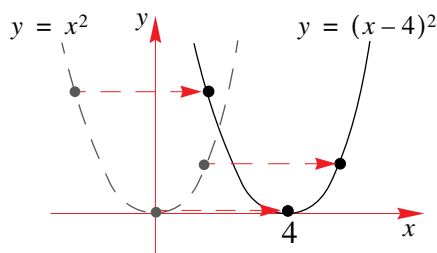

Similarly, the graph of $y = (x + 2)^2$ represents the parabola $y = x^2$ translated 2 units to the left ($a = -2$):

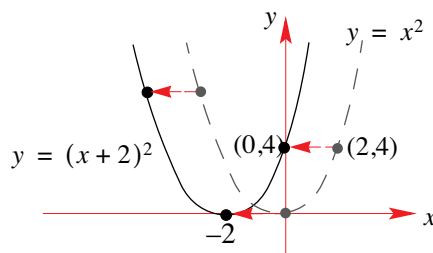

In both situations, it appears as if the graphs have been translated in the ‘opposite direction’ to the sign of ‘ a ’. That is, $y = (x + 2)^2$ has been translated 2 units back (i.e., in the negative direction), while $y = (x - 2)^2$ has been translated 2 units forward (i.e., in the positive direction).

The reason for this is that **the transformation is applied to the x -values, not the graph!**

That is, given $y = f(x)$, the graph of $y = f(x + 2)$ is telling us to ‘Add two units to all the x -values’. In turn, this means, that the combined x/y -axes should be moved in the positive direction by two units (whilst the graph of $y = f(x)$ remains exactly where it is):

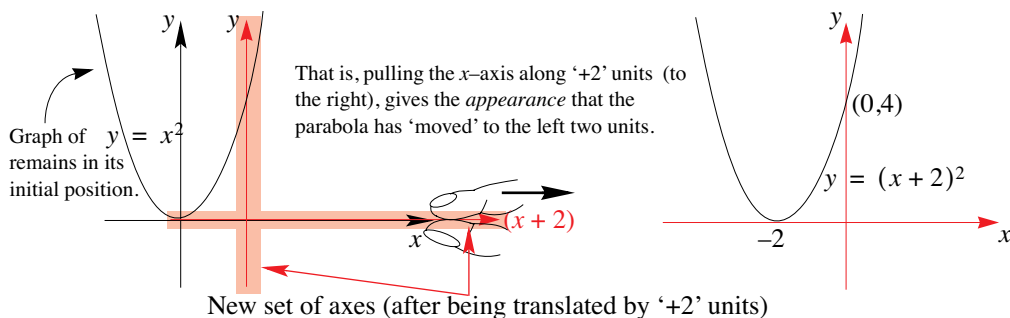

Similarly, given $y = f(x)$, the graph of $y = f(x - 1)$ is telling us to ‘Subtract one unit from all the x -values’. In turn, this means, that the combined x/y -axes should be moved in the negative direction by one unit (while maintaining the graph of $y = f(x)$ fixed at its original position):

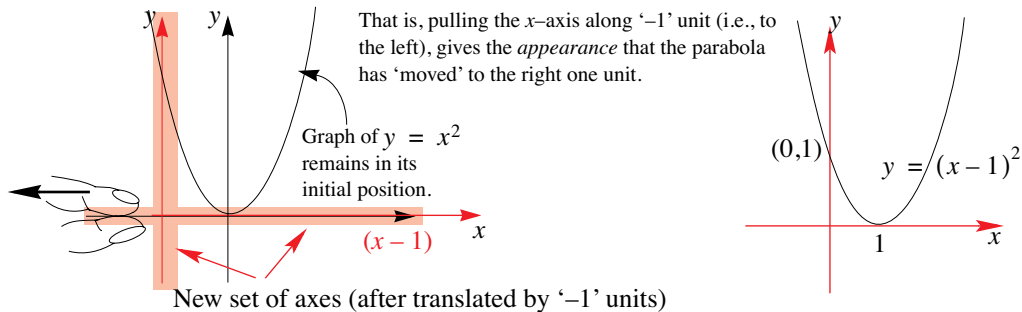

However, whenever we are asked to sketch a graph, rather than drawing the axes after the graph has been sketched, the first thing we do is draw the set of axes and then sketch the graph. This is why there appears to be a sense in which we seem to do the ‘opposite’ when sketching graphs that involve transformations.

EXAMPLE 6.1

Given the graph of $y = f(x)$ sketch the graph of

- (a) $y = f(x+1)$ (b) $y = f\left(x-\frac{1}{2}\right)$

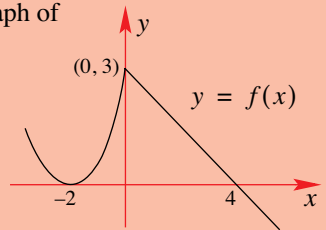

S
o
l
u
t
i
o
n

- (a) The graph of $y = f(x+1)$ represents a translation along the x -axis of the graph of $y = f(x)$ by 1 unit to the left.

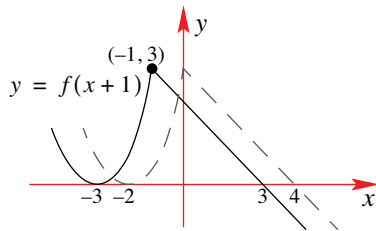

- (b) The graph of $y = f\left(x-\frac{1}{2}\right)$ represents a translation along the x -axis of the graph of $y = f(x)$ by $\frac{1}{2}$ unit to the right.

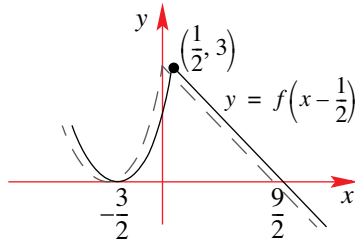

The mapping from the original coordinates (x, y) to the new coordinates (x', y') can also be presented in vector form. That is, if the point (x, y) is translated ‘ a ’ units along the x -axis, the new coordinates would be given by $(x+a, y)$

That is, $x' = x+a$ and $y' = y$.

The vector notation for such a translation is given by:

$$\begin{pmatrix} x' \\ y' \end{pmatrix} = \begin{pmatrix} x \\ y \end{pmatrix} + \begin{pmatrix} a \\ 0 \end{pmatrix}$$

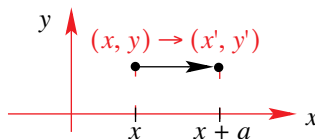

From $\begin{pmatrix} x' \\ y' \end{pmatrix} = \begin{pmatrix} x \\ y \end{pmatrix} + \begin{pmatrix} a \\ 0 \end{pmatrix}$ we then have that

$$\begin{pmatrix} x \\ y \end{pmatrix} = \begin{pmatrix} x' \\ y' \end{pmatrix} - \begin{pmatrix} a \\ 0 \end{pmatrix} \Leftrightarrow \begin{pmatrix} x \\ y \end{pmatrix} = \begin{pmatrix} x' - a \\ y' \end{pmatrix} \therefore x = x' - a \text{ and } y = y'$$

Substituting these results into the equation $y = f(x)$ we obtain the transformed equation

$$y' = f(x' - a)$$

As x' and y' are only dummy variables, we can rewrite this last equation as $y = f(x - a)$.

Under the vector translation $\begin{pmatrix} a \\ 0 \end{pmatrix}$, we have the mapping $f(x) \rightarrow f(x - a)$

EXAMPLE 6.2

Find the equation of the relation under the translation vector indicated.

(a) $x^2 + y^2 = 9$; $\begin{pmatrix} 3 \\ 0 \end{pmatrix}$ (b) $xy = 4$; $\begin{pmatrix} -2 \\ 0 \end{pmatrix}$.

Sketch both the original and transformed graph on the same set of axes.

Solution

(a) Under the vector transformation we have $\begin{pmatrix} x' \\ y' \end{pmatrix} = \begin{pmatrix} x \\ y \end{pmatrix} + \begin{pmatrix} 3 \\ 0 \end{pmatrix}$.

Meaning that $x' = x + 3 \Rightarrow x = x' - 3$ – (1) and $y = y'$ – (2).

Substituting (1) and (2) into the equation $x^2 + y^2 = 9$ gives $(x' - 3)^2 + (y')^2 = 9$.

Dropping off the dashes we then have the transformed equation $(x - 3)^2 + y^2 = 9$.

(b) Under the vector transformation we have $\begin{pmatrix} x' \\ y' \end{pmatrix} = \begin{pmatrix} x \\ y \end{pmatrix} + \begin{pmatrix} -2 \\ 0 \end{pmatrix}$.

Meaning that $x' = x - 2 \Rightarrow x = x' + 2$ – (1) and $y = y'$ – (2).

Substituting (1) and (2) into the equation $xy = 4$ gives $(x' + 2)y' = 4$.

Dropping off the dashes we then have the transformed equation $(x + 2)y = 4$ or $y = \frac{4}{x + 2}$.

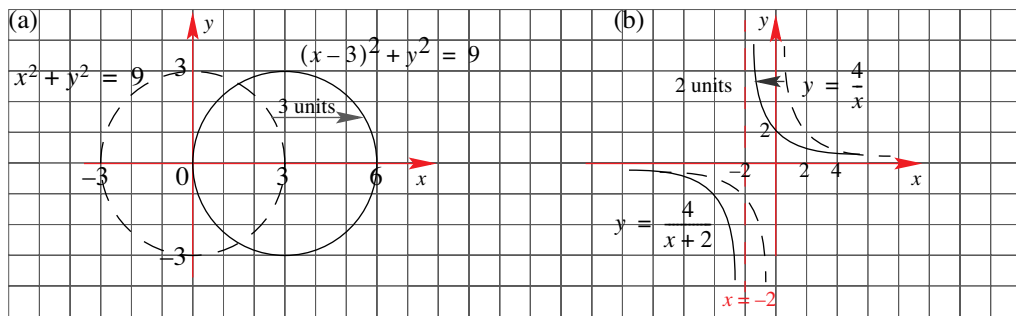

6.1.2 VERTICAL TRANSLATION

A vertical translation takes on the form $f(x) \rightarrow f(x) + b$.

Again we consider the transformation of the basic parabolic graph with equation $y = x^2$. The vertical translation of $y = x^2$ is given by $y = x^2 + b$. This transformation represents a **translation along the y-axis**.

For example, the graph of $y = x^2 - 2$ represents the parabola $y = x^2$ translated 2 units down:

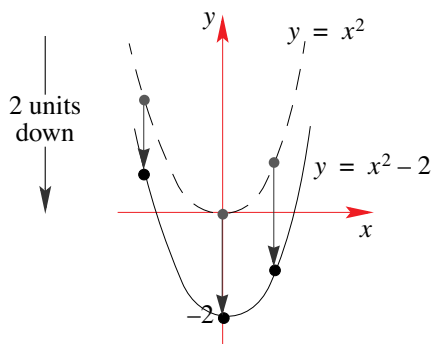

Similarly, the graph of $y = x^2 + 1$ represents the parabola $y = x^2$ translated 1 unit up:

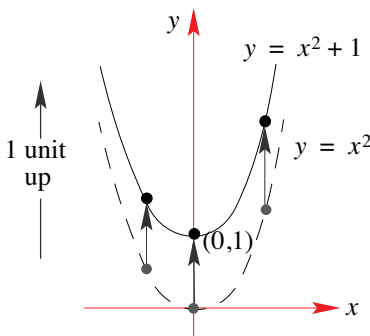

Note that this time, when applying a vertical translation, we are consistent with the sign of b !

The reason being that although we are sketching the graph of $y = f(x) + b$, we are in fact sketching the graph of $y - b = f(x)$. So that this time, **the transformation is applied to the y-values, and not the graph!**

So, if we consider the two previous examples, we have $y = x^2 - 2 \Leftrightarrow y + 2 = x^2$, and so, in this case we would be pulling the y-axis **UP** 2 units, which gives the appearance that the parabola has been moved down 2 units.

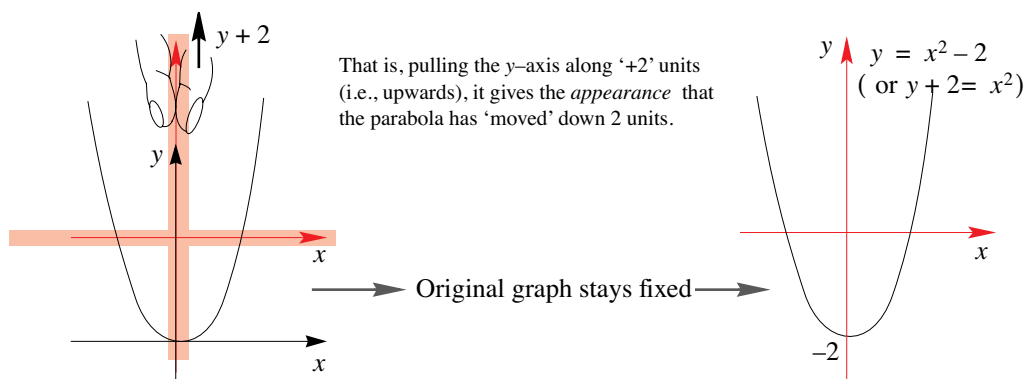

Similarly, $y = x^2 + 1 \Leftrightarrow y - 1 = x^2$, so that in this case we would be pulling the y-axis **DOWN** 1 unit, which gives the appearance that the parabola has been moved up 1 unit.

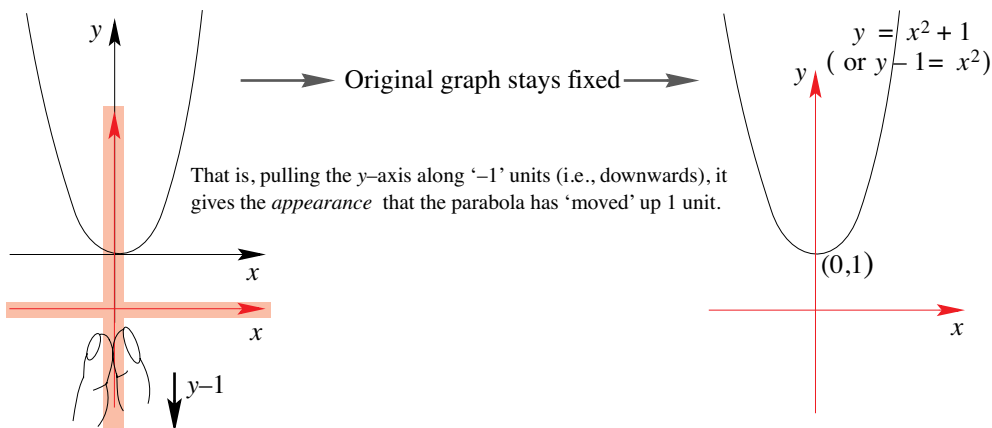

EXAMPLE 6.3

Given the graph of $y = f(x)$ sketch the graph of

- (a) $y = f(x) - 3$ (b) $y = f(x) + 2$

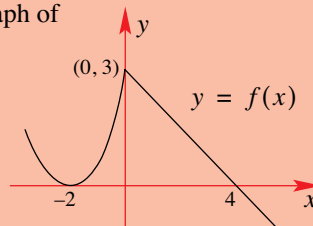

S
o
l
u
t
i
o
n

- (a) The graph of $y = f(x) - 3$ represents a translation along the y -axis of the graph of $y = f(x)$ by 3 units in the downward direction.

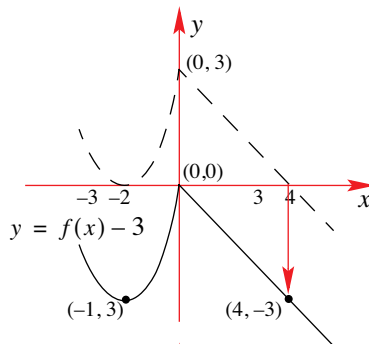

- (b) The graph of $y = f(x) + 2$ represents a translation along the y -axis of the graph of $y = f(x)$ by 2 units in the upward direction.

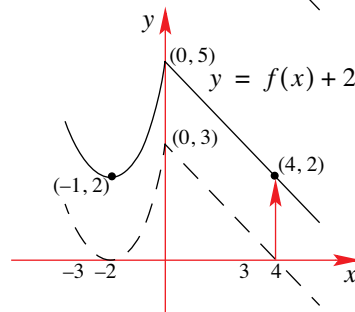

The mapping from the original coordinates (x, y) to the new coordinates (x', y') can also be presented in vector form. That is, if the point (x, y) is translated ' b ' units along the y -axis, the new coordinates would be given by $(x, y + b)$

MATHEMATICS – Higher Level (Core)

That is, $x' = x$ and $y' = y + b$.

The vector notation for such a translation is given by:

$$\begin{pmatrix} x' \\ y' \end{pmatrix} = \begin{pmatrix} x \\ y \end{pmatrix} + \begin{pmatrix} 0 \\ b \end{pmatrix}$$

From $\begin{pmatrix} x' \\ y' \end{pmatrix} = \begin{pmatrix} x \\ y \end{pmatrix} + \begin{pmatrix} 0 \\ b \end{pmatrix}$ we then have that

$$\begin{pmatrix} x \\ y \end{pmatrix} = \begin{pmatrix} x' \\ y' \end{pmatrix} - \begin{pmatrix} 0 \\ b \end{pmatrix} \Leftrightarrow \begin{pmatrix} x \\ y \end{pmatrix} = \begin{pmatrix} x' \\ y' - b \end{pmatrix} \therefore x = x' \text{ and } y = y' - b$$

Then, substituting these results into the equation $y = f(x)$ we obtain the transformed equation

$$y' - b = f(x') \Rightarrow y' = f(x') + b$$

As x' and y' are only dummy variables, we can rewrite this last equation as $y = f(x) + b$.

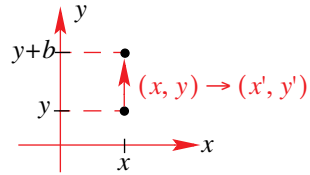

Under the vector translation $\begin{pmatrix} 0 \\ b \end{pmatrix}$, we have the mapping $f(x) \rightarrow f(x) + b$

EXAMPLE 6.4

Find the equation of the relation under the translation vector indicated.

- (a) $x^2 + y^2 = 9$; $\begin{pmatrix} 0 \\ 3 \end{pmatrix}$ (b) $xy = 4$; $\begin{pmatrix} 0 \\ -2 \end{pmatrix}$.

Sketch both the original and transformed graph on the same set of axes.

Solution

- (a) Under the vector transformation we have $\begin{pmatrix} x' \\ y' \end{pmatrix} = \begin{pmatrix} x \\ y \end{pmatrix} + \begin{pmatrix} 0 \\ 3 \end{pmatrix}$.

Meaning that $y' = y + 3 \Rightarrow y = y' - 3$ — (1) and $x = x'$ — (2).

Substituting (1) and (2) into the equation $x^2 + y^2 = 9$ gives $(x')^2 + (y' - 3)^2 = 9$.

Dropping off the dashes we then have the transformed equation $x^2 + (y - 3)^2 = 9$.

- (b) Under the vector transformation we have $\begin{pmatrix} x' \\ y' \end{pmatrix} = \begin{pmatrix} x \\ y \end{pmatrix} + \begin{pmatrix} 0 \\ -2 \end{pmatrix}$.

Meaning that $y' = y - 2 \Rightarrow y = y' + 2$ — (1) and $x = x'$ — (2).

Substituting (1) and (2) into the equation $xy = 4$ gives $x'(y' + 2) = 4$.

Dropping off the dashes we then have the transformed equation $x(y + 2) = 4$ or $y = \frac{4}{x} - 2$.

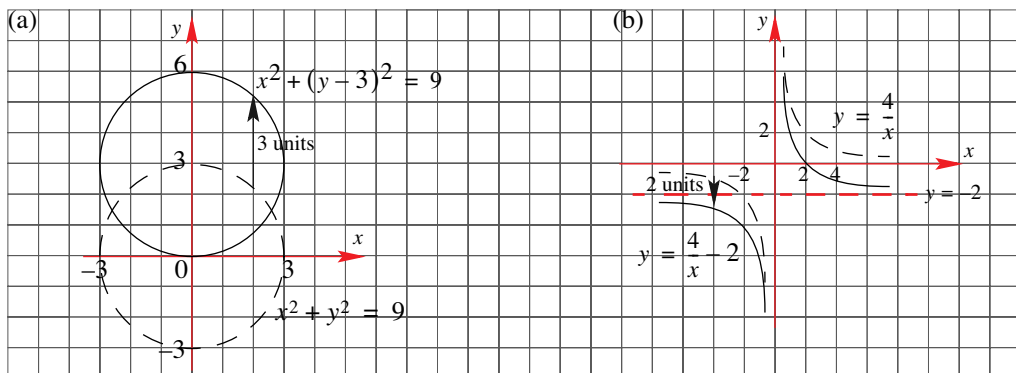

SUMMARY

$y = f(x - a)$, $a > 0$: translation of $f(x)$ along the x -axis of a units to the right.

$y = f(x + a)$, $a > 0$: translation of $f(x)$ along the x -axis of a units to the left.

$y = f(x) + b$, $b > 0$: translation of $f(x)$ along the y -axis of b units up.

$y = f(x) - b$, $b > 0$: translation of $f(x)$ along the y -axis of b units down.

Of course it is also possible to apply both a vertical and horizontal translation to the one graph at the same time. That is, the graph of $y = (x - 1)^2 + 2$ would represent the graph of $y = x^2$ after it had been translated one unit to the right and two units up.

Such a combination takes on the form $f(x) \rightarrow f(x - a) + b$, representing a horizontal translation of ' a ' along the x -axis and a vertical translation of ' b ' along the y -axis.

EXAMPLE 6.5

Sketch the graph of $y = f(x - 3) - 1$ for the graph shown.

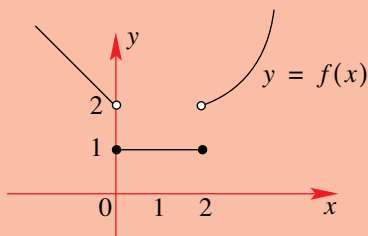
Solution

The graph of $y = f(x - 3) - 1$ represents the graph of $y = f(x)$ after a translation along the x -axis of 3 units to the right followed by a translation along the y -axis 1 unit down.

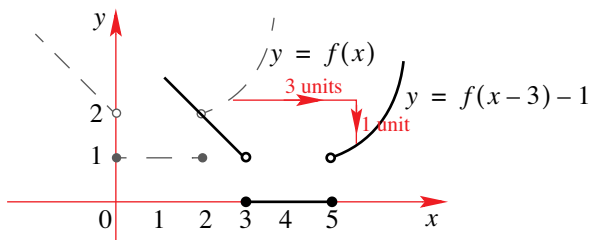

The mapping from the original coordinates (x, y) to the new coordinates (x', y') can also be presented in vector form. That is, if the point (x, y) is translated ' a ' units along the x -axis and ' b ' units along the y -axis, the new coordinates would be given by $(x + a, y + b)$

That is, $x' = x + a$ and $y' = y + b$.

The vector notation for such a translation is given by:

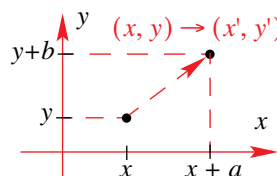
$$\begin{pmatrix} x' \\ y' \end{pmatrix} = \begin{pmatrix} x \\ y \end{pmatrix} + \begin{pmatrix} a \\ b \end{pmatrix}$$

MATHEMATICS – Higher Level (Core)

From $\begin{pmatrix} x' \\ y' \end{pmatrix} = \begin{pmatrix} x \\ y \end{pmatrix} + \begin{pmatrix} a \\ b \end{pmatrix}$ we then have that

$$\begin{pmatrix} x \\ y \end{pmatrix} = \begin{pmatrix} x' \\ y' \end{pmatrix} - \begin{pmatrix} a \\ b \end{pmatrix} \Leftrightarrow \begin{pmatrix} x \\ y \end{pmatrix} = \begin{pmatrix} x' - a \\ y' - b \end{pmatrix} \therefore x = x' - a \text{ and } y = y' - b$$

Substituting these results into the equation $y = f(x)$ we obtain the transformed equation

$$y' - b = f(x' - a) \Rightarrow y' = f(x' - a) + b$$

As x' and y' are only dummy variables, we can rewrite this last equation as $y = f(x - a) + b$.

Under the vector translation $\begin{pmatrix} a \\ b \end{pmatrix}$, we have the mapping $f(x) \rightarrow f(x - a) + b$

EXAMPLE 6.6

Find the equation of $y = x^3 - 1$ under the translation $\begin{pmatrix} 3 \\ 5 \end{pmatrix}$.

Solution

Let the new set of axis be u and v so that $\begin{pmatrix} u \\ v \end{pmatrix} = \begin{pmatrix} x \\ y \end{pmatrix} + \begin{pmatrix} 3 \\ 5 \end{pmatrix} \Rightarrow \begin{cases} u = x + 3 \\ v = y + 5 \end{cases} \text{ or } \begin{cases} x = u - 3 \\ y = v - 5 \end{cases}$.

Substituting these into $y = x^3 - 1$, we have $v - 5 = (u - 3)^3 - 1 \Rightarrow v = (u - 3)^3 + 4$.

However, u and v are dummy variables, and so we can rewrite the last equation in terms of x and y , i.e., $y = (x - 3)^3 + 4$.

This represents the graph of $y = x^3$ translated 3 units to the right (along the x -axis) and 4 units up (along the y -axis).

Notice that the original relation is in fact $y = x^3 - 1$, so that relative to this graph, the graph of $y = (x - 3)^3 + 4$ has been translated 3 units to the right (along the x -axis) and 5 units up (along the y -axis).

EXERCISES 6.1

1. Find the equation of the given relation under the translation indicated.

- (a) $y = x^2$; $\begin{pmatrix} 4 \\ 0 \end{pmatrix}$ (b) $y = x^2$; $\begin{pmatrix} -2 \\ 0 \end{pmatrix}$ (c) $y = x^2$; $\begin{pmatrix} 0 \\ 5 \end{pmatrix}$
(d) $x^2 + y = 2$; $\begin{pmatrix} 2 \\ 0 \end{pmatrix}$ (e) $x^2 + y = 2$; $\begin{pmatrix} 0 \\ 2 \end{pmatrix}$ (f) $x^2 + y = 2$; $\begin{pmatrix} 0 \\ -2 \end{pmatrix}$
(g) $xy = 8$; $\begin{pmatrix} 4 \\ 0 \end{pmatrix}$ (h) $xy = 8$; $\begin{pmatrix} 0 \\ -1 \end{pmatrix}$ (i) $x^2 + y^2 = 4$; $\begin{pmatrix} -1 \\ 0 \end{pmatrix}$
(j) $xy^2 = 9$; $\begin{pmatrix} 3 \\ 0 \end{pmatrix}$ (k) $xy^2 = 9$; $\begin{pmatrix} 0 \\ -3 \end{pmatrix}$ (l) $x + y^2 = 4$; $\begin{pmatrix} 4 \\ 0 \end{pmatrix}$

2. Consider the graphs shown below.

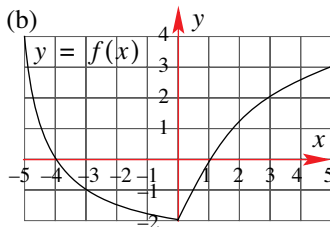
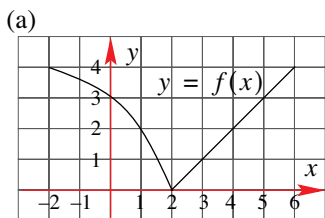

In each case, sketch the graph of

- i. $y = f(x + 2)$ ii. $y = f(x - 1)$
 iii. $y = f(x) - 3$ iv. $y = f(x) + 1$

3. Using translations on the graph of $f(x) = \sqrt{x}$, sketch the graph of the following
 (a) $y = f(x - 4)$ (b) $y = f(x) - 2$ (c) $y = f(x - 2) + 3$

4. Using translations on the graph of $f(x) = \frac{1}{x}$, sketch the graph of the following
 (a) $y = f(x + 1)$ (b) $y = f(x) - 4$ (c) $y = f(x + 2) - 3$

5. Using translations on the graph of $f(x) = \frac{1}{x^2}$, sketch the graph of the following

- (a) $y = f(x) - 1$ (b) $y = f(x - 1)$ (c) $y = 2 + f\left(x - \frac{3}{2}\right)$

6. On the same set of axes sketch the graphs of

- (a) $y = x^2 - 4$ and $y = (x - 4)^2$ (b) $y = x^2 + 5$ and $y = (x + 5)^2$
 (c) $y = x^2 + 2$ and $y = x^2 - 2$ (d) $y = \left(x + \frac{3}{2}\right)^2$ and $y = \left(x - \frac{3}{2}\right)^2$
 (e) $y = x^3 - 8$ and $y = (x - 8)^3$ (f) $y = (x + 1)^3$ and $y = x^3 + 1$
 (g) $y = \frac{1}{(x - 2)}$ and $y = \frac{1}{x} - 2$ (h) $y = \frac{1}{(x + 3)}$ and $y = \frac{1}{x} + 3$
 (i) $y = \sqrt{x - 2}$ and $y = \sqrt{x} - 2$ (j) $y = \sqrt{x + 4}$ and $y = \sqrt{x} + 4$

7. Sketch the graph of the following functions, making sure to include all axial intercepts and labelling the equations of asymptotes (where they exist).

- (a) $y = (x - 2)^2 + 3$ (b) $y = \frac{1}{x + 1} + 2$ (c) $y = (x - 1)^3 - 1$
 (d) $y = \frac{1}{x - 2} + \frac{1}{2}$ (e) $y = (x + 2)^3 - 8$ (f) $y = (x + 3)^2 - 9$
 (g) $y = \sqrt{x - 2} + 2$ (h) $y = \sqrt{4 + x} + 2$ (i) $y = (1 + x)^2 - 1$
 (j) $y = 1 + \frac{1}{3 + x}$ (k) $y = \frac{1}{(x - 1)^2} - 1$ (l) $y = -2 + \frac{1}{(2 - x)^2}$
 (m) $y = 2 - \frac{1}{3 - x}$ (n) $y = 8 - (2 - x)^3$ (o) $y = -2 + \sqrt{x - 4}$

8. Find the vector translation necessary for the following mappings

- (a) $x^2 \mapsto x^2 + 4$ (b) $x^3 \mapsto x^3 - 2$ (c) $\sqrt{x} \mapsto \sqrt{x+1}$
 (d) $\frac{1}{x} \mapsto \frac{1}{x-2}$ (e) $x^4 \mapsto (x+2)^4$ (f) $\frac{1}{x^2} \mapsto \frac{1}{x^2} - 4$
 (g) $x^3 \mapsto (x-2)^3 - 2$ (h) $\frac{1}{x} \mapsto 3 + \frac{1}{x+2}$ (i) $x^2 \mapsto 2 + (x-4)^2$
 (j) $\sqrt{x} \mapsto 3 + \sqrt{x-2}$ (k) $\frac{1}{x^3} \mapsto \frac{1}{(x-3)^3} - 1$ (l) $f(x) \mapsto h + f(x+k)$
 (m) $x^2 - 4 \mapsto (x+2)^2$ (n) $x^3 + 1 \mapsto (x-1)^3$ (o) $\frac{1}{x} - 2 \mapsto \frac{1}{x+1}$

9. Express, in terms of $f(x)$, the transformation(s) required to map $f(x)$ to $g(x)$.

- (a) $f(x) = x^2, g(x) = x^2 - 2x + 2$
 (b) $f(x) = x^2, g(x) = x^2 + 4x$
 (c) $f(x) = x^3, g(x) = x^3 - 6x^2 + 12x - 8$
 (d) $f(x) = \frac{1}{x^2}, g(x) = \frac{1}{x^2 - 2x + 1} + 1$
 (e) $f(x) = x^3, g(x) = x^3 - 3x^2 + 3x + 2$

10. Consider the relations shown below.

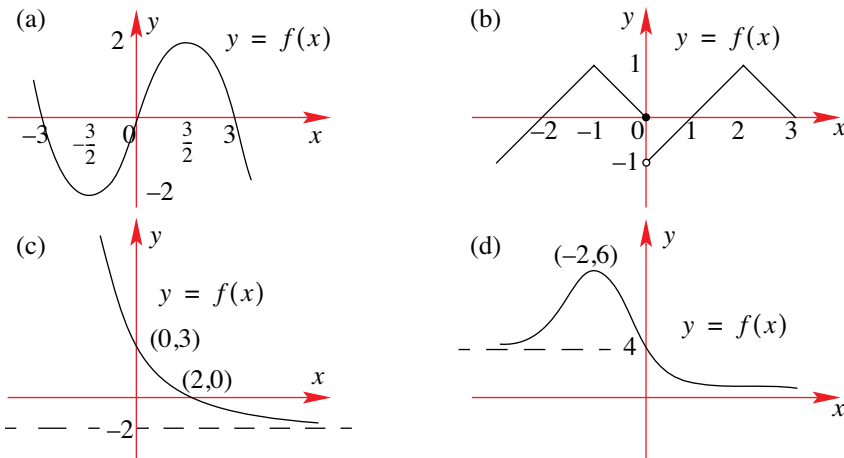

Sketch the following

- i. $y = f(x+2) - 2$ ii. $y = f(x-2) - 4$
 iii. $y = 3 + f(x-3)$ iv. $y = 1 + f(x+1)$

11. Express, in terms of $f(x)$, the equation of the graph represented in Figure 2, given that the graph in Figure 1 has the equation $y = f(x), -1 \leq x \leq 1$.

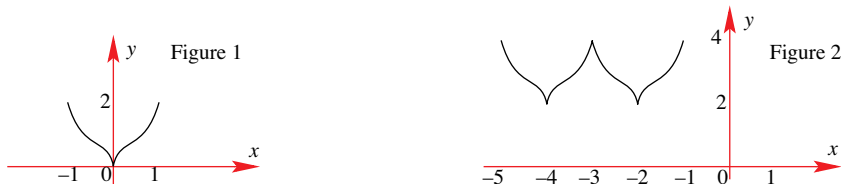

6.2 DILATIONS

6.2.1 DILATION FROM THE X-AXIS

Before we start our discussion it should be pointed out that other commonly used expressions for *dilations from the x-axis* are; *dilation along the y-axis* and *dilation parallel to the y-axis* – either of these three expressions can be used when describing this dilation.

The equation $y = pf(x)$ can be written as $\frac{y}{p} = f(x)$. We have rearranged the expression so that

we can more clearly see the effects that p has on the y -values. That is, the term $\frac{y}{p}$ represents a transformation on the y -axis as opposed to a transformation on the graph of $f(x)$. The effect of ‘ p ’ in the term $\frac{y}{p}$ is that of a **dilation from the x-axis**.

If $|p| > 1$, we *shrink* the y -axis (seeing as we are dividing the y -values by a number larger than one). Whereas if $0 < |p| < 1$ we *stretch* the y -axis.

However, we still need to describe the effect this transformation has on the final appearance of the graph of $f(x)$.

We summarise these results, stating the **effects on the graph of $f(x)$** :

For the curve with equation $y = pf(x)$,

$|p| > 1$, represents ‘**stretching**’ $f(x)$ by a factor p from the x -axis.

$0 < |p| < 1$, represents ‘**shrinking**’ $f(x)$ by a factor $\frac{1}{p}$ from the x -axis

Realise that quoting a ‘stretch’ of factor $\frac{1}{3}$ is the same as quoting a ‘shrink’ of factor 3. However, it is more common that when referring to a dilation from the x -axis we are referring to a stretch. So a dilation from the x -axis of factor 3 would imply a stretching effect whereas a dilation from the x -axis of factor $\frac{1}{3}$ would imply a shrinking effect.

The relationship between the the original coordinates (x, y) and the new coordinates (x', y') can be seen in the diagram below.

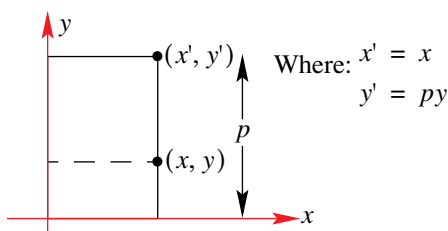

Unfortunately, unlike the translation vector of §6.1, we have no dilation vector to describe this transformation [although there does exist a *dilation matrix*].

EXAMPLE 6.7

Describe the effects on the graph of $y = f(x)$ when the following graphs

are sketched

(a) $y = 2f(x)$

(b) $y = \frac{1}{4}f(x)$

(c) $2y = f(x)$

S
o
l
u
t
i
o
n

(a) $y = 2f(x)$ represents a dilation of factor 2 from the x -axis. This means that the graph of $y = f(x)$ would be stretched by a factor of two along the y -axis.

(b) $y = \frac{1}{4}f(x)$ represents a dilation of factor $\frac{1}{4}$ from the x -axis. This means that the graph of $y = f(x)$ would shrink by a factor of four along the y -axis.

(c) $2y = f(x)$ needs to first be written as $y = \frac{1}{2}f(x)$, which represents a dilation of factor $\frac{1}{2}$ from the x -axis. This means that the graph of $y = f(x)$ would shrink by a factor of two along the y -axis.

EXAMPLE 6.8

Given the graph of $y = f(x)$ sketch the graph of

(a) $y = 2f(x)$

(b) $3y = f(x)$

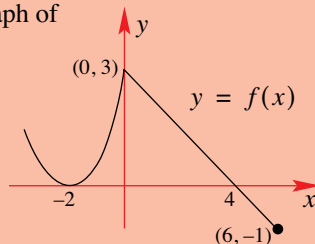

S
o
l
u
t
i
o
n

(a) The graph of $y = 2f(x)$ represents a dilation of factor 2 – i.e., the graph of $y = f(x)$ will be stretched by a factor of 2. Notice how the x -intercepts are invariant – i.e., they have not altered after the transformation. This is because the y -value at these points is zero, and multiplying zero by any number will still be zero.

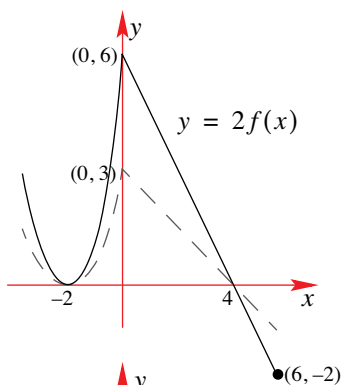

(b) $3y = f(x) \Leftrightarrow y = \frac{1}{3}f(x)$ which represents a dilation of factor $\frac{1}{3}$. – i.e., the graph of $y = f(x)$ will shrink by a factor of 3.

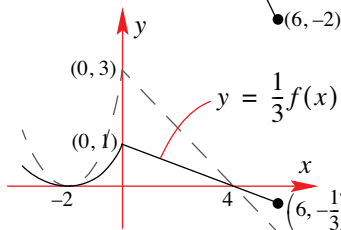

6.2.2 DILATION FROM THE Y-AXIS

The equation $y = f\left(\frac{x}{q}\right)$ represents a transformation applied to the x -values. We now need to consider how this factor ‘ q ’ affects the graph of $f(x)$. The term $\frac{x}{q}$ represents a transformation on the x -values as opposed to a transformation on the graph of $f(x)$. The effect of ‘ q ’ in the term $\frac{x}{q}$ is that of a **dilation from the y -axis**.

If $|q| > 1$, we *shrink* the x -axis (seeing as we are dividing the x -values by a number larger than one). Whereas if $0 < |q| < 1$ we *stretch* the x -axis (because we are dividing by a number less than one but greater than zero).

However, we still need to describe the effect this transformation has on the final appearance of the graph of $f(x)$.

We summarise these results, stating the **effects on the graph of $f(x)$** :

For the curve with equation $y = f(x/q)$,

$|q| > 1$, represents ‘**stretching**’ $f(x)$ by a factor q from the y -axis.

$0 < |q| < 1$, represents ‘**shrinking**’ $f(x)$ by a factor $\frac{1}{q}$ from the y -axis

So a dilation from the y -axis of factor 2 (e.g., $y = f(x/2)$) would imply a stretching effect whereas a dilation from the y -axis of factor $\frac{1}{2}$ (e.g., $y = f(2x)$) would imply a shrinking effect. We show this in the diagram below:

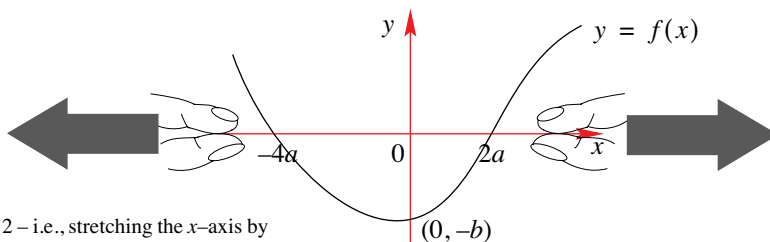

Multiplying the x -values by 2 – i.e., stretching the x -axis by a factor of 2 has the same effect as squashing the graph of $y = f(x)$ by a factor of 2.

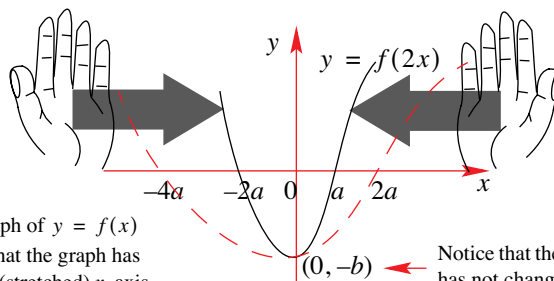

Again, it must be remembered that the graph of $y = f(x)$ has not changed, it is simply the illusion that the graph has been squashed. That is, relative to the new (stretched) x -axis, the graph of $y = f(x)$ appears to have been squashed.

Notice that the y -intercept has not changed!

MATHEMATICS – Higher Level (Core)

The relationship between the the original coordinates (x, y) and the new coordinates (x', y') can be seen in the diagram below.

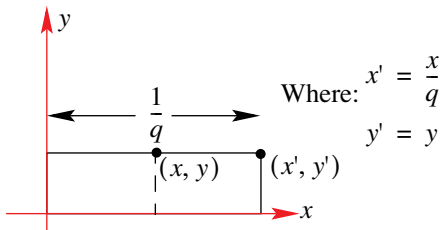

Again, we have no dilation vector to describe this transformation [although there does exist a *dilation matrix*].

EXAMPLE 6.9

Given the graph of $y = f(x)$ sketch the graph of

(a) $y = f(2x)$

(b) $y = f\left(\frac{x}{3}\right)$

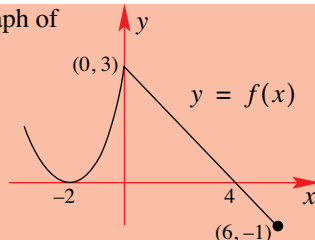

Solution (a) We first express the dilation in the form $y = f(x/q) : y = f(2x) \Rightarrow y = f\left(x/\left(\frac{1}{2}\right)\right)$.

This means that we have a dilation from the y -axis of factor $\frac{1}{2}$. That is, the graph of $y = f(x)$ will 'shrink' [or rather be squashed] by a factor of 2.

i.e., because the x -values are doubled (from the $2x$ term in the expression $y = f(2x)$) it seems reasonable to deduce that on the new set of axes the graph will be squashed by a factor of 2.

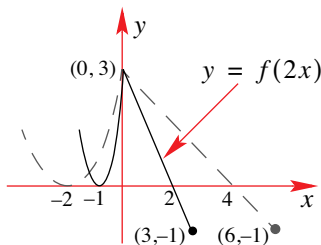

(b) The term $\frac{x}{3}$ in the expression $y = f\left(\frac{x}{3}\right)$ implies that the new x -values will be a third of the original x -values, this means that the new x -axis will be compressed by a factor of 3. This in turn will have a stretching effect on $y = f(x)$ of factor 3 (along the x -axis).

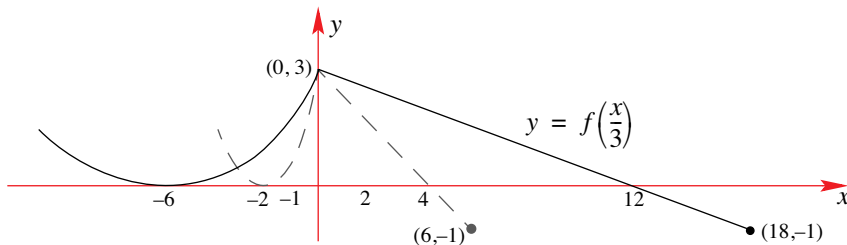

EXERCISES 6.2

1. On the same set of axes sketch the graphs of

(a) $f(x) = x^2, y = f(2x)$

(b) $f(x) = \sqrt{x}, y = f(4x)$

(c) $f(x) = \frac{1}{x}, y = f\left(\frac{x}{3}\right)$

(d) $f(x) = x^3, y = f\left(\frac{x}{2}\right)$

2. On the same set of axes sketch the graphs of

(a) $f(x) = x^2, y = 2f(x)$

(b) $f(x) = \sqrt{x}, y = 4f(x)$

(c) $f(x) = \frac{1}{x}, y = \frac{1}{3}f(x)$

(d) $f(x) = x^3, y = \frac{1}{2}f(x)$

3. Consider the graphs shown below.

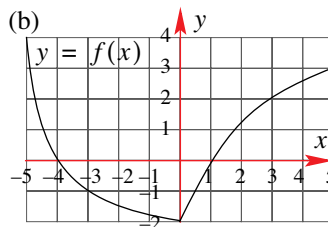
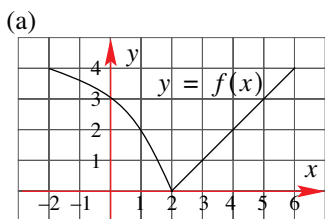

In each case, sketch the graph of

i. $y = f(0.5x)$

ii. $y = f(2x)$

iii. $y = 0.5f(x)$

iv. $y = 2f(x)$

4. Consider the relations shown below.

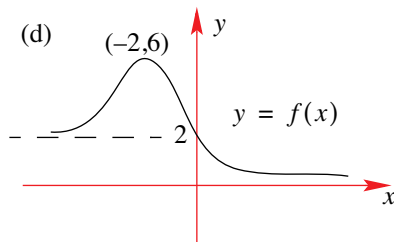
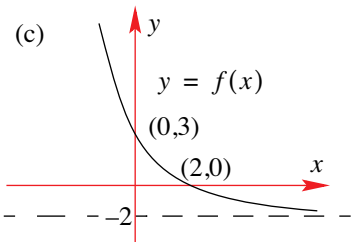
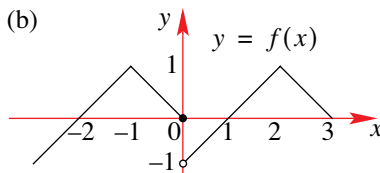
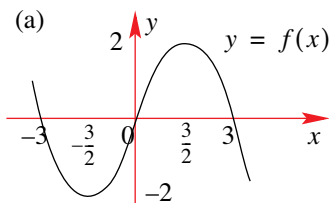

Sketch the following

i. $y = f\left(\frac{2}{3}x\right)$

ii. $y = 4f(x)$

MATHEMATICS – Higher Level (Core)

5. Describe the transformation(s) under the following mappings

- (a) $|x| \mapsto |2x| + 1$ (b) $x^2 \mapsto \frac{1}{2}(x-2)^2 - 3$ (c) $\frac{1}{x} \mapsto \frac{1}{2x-1}$
 (d) $x^3 \mapsto (3x-2)^3$ (e) $x^4 \mapsto \frac{1}{2}(4x-2)^4 - 2$ (f) $\sqrt{x} \mapsto \frac{1}{2}\sqrt{8x} + 2$

6. For the graph shown below, sketch each of the following on a separate set of axes.

- (a) $y = 2f(x) - 1$ (b) $y = 2f(x-1)$ (c) $y = f(2x-1)$

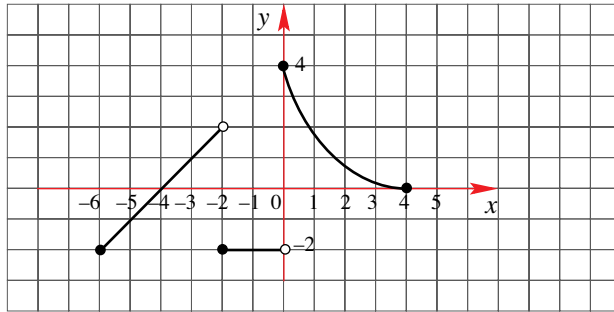

7. Consider the function $g(x) = \begin{cases} x^2 & \text{if } x \geq 2 \\ 6-x & \text{if } x < 2 \end{cases}$.

- (a) Find an expression for
 i. $f(x) = g(x+2)$ ii. $h(x) = g(x)-3$
 iii. $h(x) = 2g(x)$ iv. $k(x) = g(2x)$
 v. $k(x) = g(2x-1)$ vi. $f(x) = \frac{1}{2}g(4x+2)$

(b) On separate sets of axes, sketch the graphs of each of the functions in part (a).

8. Given the relation $f(x) = \begin{cases} -\sqrt{4-(x-2)^2} & \text{if } 1 < x \leq 4 \\ \sqrt{3}x & \text{if } x \leq 1 \\ -\sqrt{3}x & \text{if } x \geq 1 \\ \sqrt{4-(x-2)^2} & \text{if } 1 < x \leq 4 \end{cases}$, sketch the graphs of

- (a) $y = \frac{1}{2}f(x)$ (b) $y = f\left(\frac{1}{2}x\right)$

9. Given the function $f(x) = \sqrt{x}$, sketch the graph of

- (a) $y = af(x), a > 0$ (b) $y = f(ax), a > 0$
 (c) $y = bf(x+b), b > 0$ (d) $y = \frac{1}{a}f(a^2x), a \neq 0$

10. Given the function $f(x) = \frac{1}{x^2}$, sketch the graph of

- (a) $y = bf(\sqrt{ax}) - a, a, b > 0$ (b) $y = bf(\sqrt{ax}) - \frac{a}{b}, a, b > 0$

6.3 REFLECTIONS

We first consider reflections about the x -axis and about the y -axis. The effects of reflecting a curve about these axes can be seen in the diagrams below:

Reflection about the x -axis

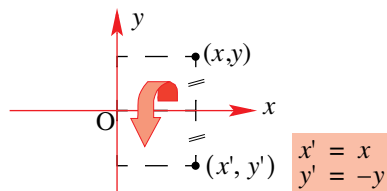

When reflecting about the x -axis we observe that the coordinates (x, y) are mapped to the coordinates $(x, -y)$. Meaning that the x -values remain the same but the y -values change sign.

Reflection about the y -axis

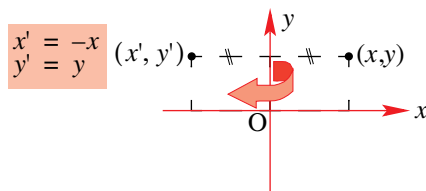

When reflecting about the y -axis we observe that the coordinates (x, y) are mapped to the coordinates $(-x, y)$. Meaning that the y -values remain the same but the x -values change sign.

We summarise the effects of these two transformations of the graph of $y = f(x)$

$y = -f(x)$, represents a **reflection of $f(x)$ about the x -axis**.

$y = f(-x)$, represents a **reflection of $f(x)$ about the y -axis**.

Another type of reflection is the reflection about the line $y = x$, when sketching the inverse of a function. Inverse functions are dealt with in detail in Chapter 5, so here we give a summary of those results.

Reflection about the line $y = x$

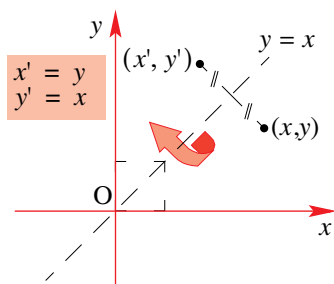

When reflecting about the line $y = x$ we observe that the coordinates (x, y) are mapped to the coordinates (y, x) . Meaning that the x -values and the y -values are interchanged.

If a **one-one function** $y = f(x)$ undergoes such a reflection, we call its transformed graph the **inverse function** and denote it by $y = f^{-1}(x)$.

EXAMPLE 6.10

Given the graph of $y = f(x)$ sketch the graph of

(a) $y = f(-x)$

(b) $y = -f(x)$

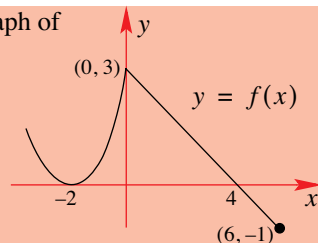

S
o
l
u
t
i
o
n

- (a) The graph of $y = f(-x)$ represents a reflection of the graph of $y = f(x)$ about the y -axis:

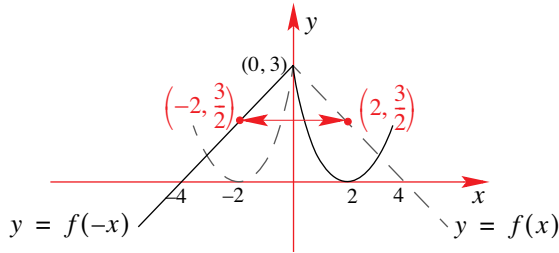

- (b) The graph of $y = -f(x)$ represents a reflection of the graph of $y = f(x)$ about the x -axis:

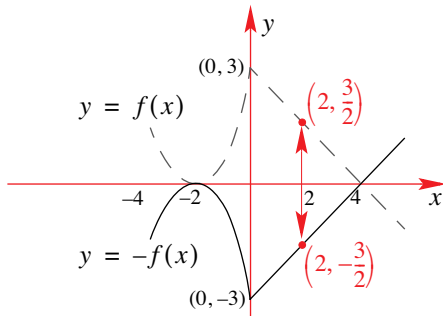

We now consider a combination of the transformations we have looked at so far.

EXAMPLE 6.11

Sketch the graph of $y = 3 - 2\sqrt{4 - x}$.

S
o
l
u
t
i
o
n

We start by considering the function $f(x) = \sqrt{x}$, then, the expression $y = 3 - 2\sqrt{4 - x}$ can be written in terms of $f(x)$ as follows: $y = 3 - 2f(4 - x)$ or $y = -2f(4 - x) + 3$.

This represents

1. reflection about the y -axis [due to the ' $-x$ ' term]
2. translation of 4 units to the right [due to the ' $4 - x$ ' term]
Note: $4 - x = -(x - 4)$
3. dilation of factor 2 along the y -axis [due to the ' $2f(x)$ ' term]
4. reflection about the x -axis [due to the ' $-$ ' in front of the ' $2f(x)$ ' term]
5. translation of 3 units up [due to the '+3' term]

We produce the final graph in stages:

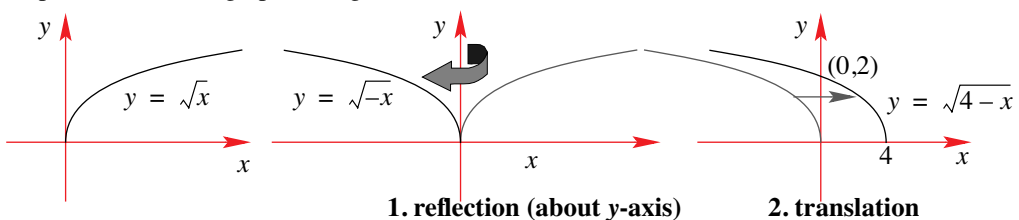

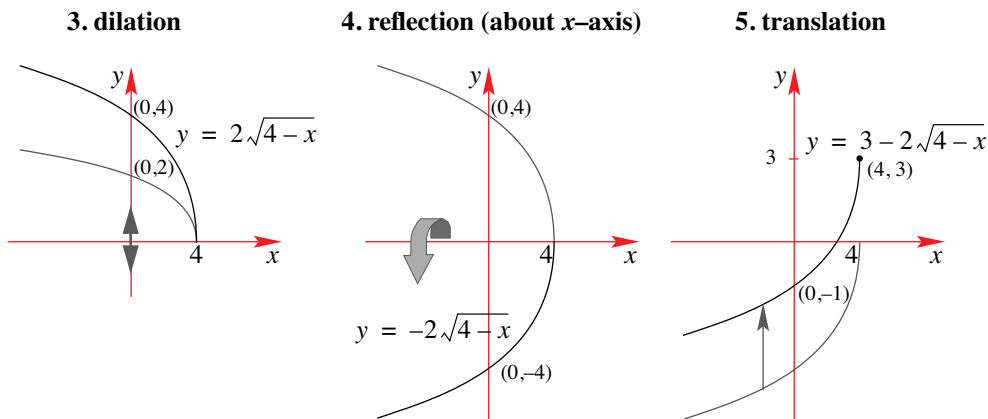

The above example gave a step by step account of how to produce the final graph, however, there is no need to draw that many graphs to produce the final outcome. We can reduce the amount of work involved by including all the transformation on one set of axes and then produce the final graph on a new set of axes.

EXAMPLE 6.12

Sketch the graph of $y = 2 - \frac{1}{2}(x + 1)^2$.

Solution If we consider the function $f(x) = x^2$, the graph of $y = 2 - \frac{1}{2}(x + 1)^2$ can be written as $y = 2 - \frac{1}{2}f(x + 1)$. This represents a ‘shrinking’ effect of factor 2 from the x -axis followed by a reflection about the x -axis then a translation of 1 to the left and finally a translation of 2 units up.

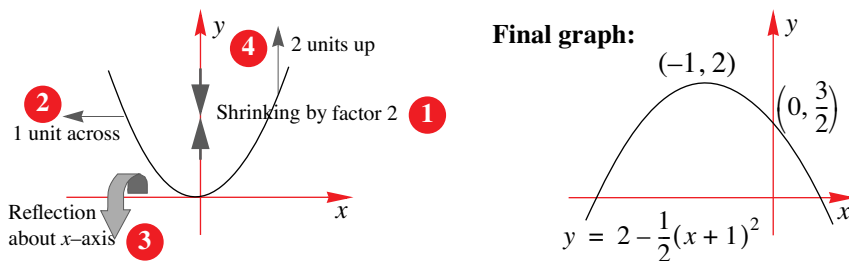

At this stage we have not looked at the x - or y -intercepts, although these should always be determined.

Important note!

Note the order in which we have carried out the transformations – although there is some freedom in which order the transformations are carried out, there are some transformations that must be carried out before others.

You should try and alter the order in which the transformations in Example 6.12 have been carried out. For example, does it matter if we apply Step 2 before Step 1. Can Step 2 be carried out after Step 4?

EXERCISES 6.3

1. Sketch the graphs of $y = f(-x)$ and $y = -f(x)$ for each of the following

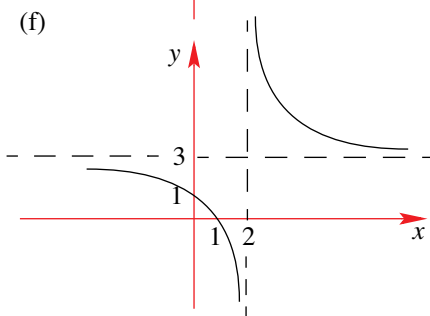
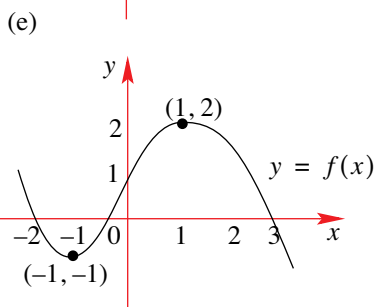
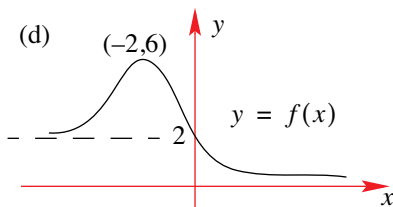
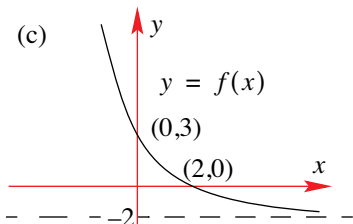
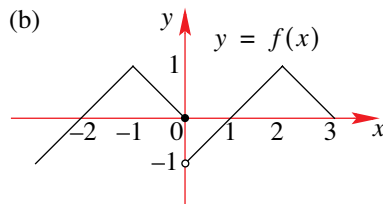
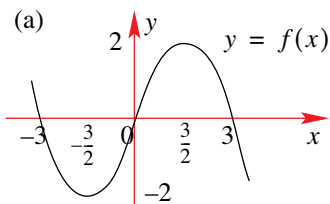

2. The diagram shows the graph of the function $y = f(x)$.

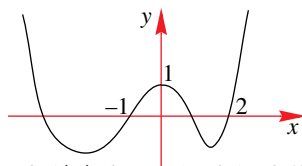

Find the equation in terms of $f(x)$ for each of the following graphs.

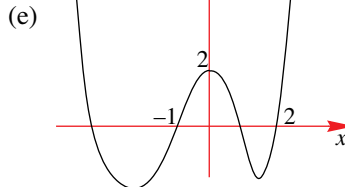
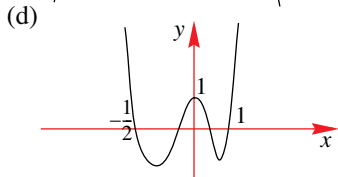
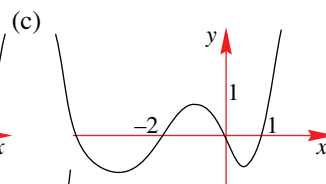
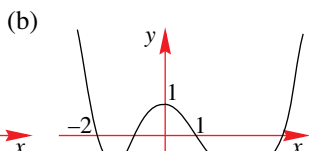
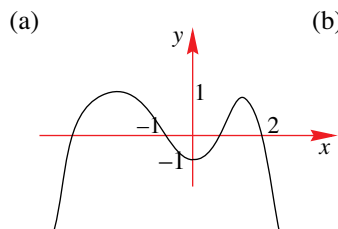

3. Sketch the graphs of the following

- (a) $f(x) = -3x^2 + 9$ (b) $f(x) = 4 - \frac{1}{2}x^2$ (c) $f(x) = 1 - \frac{1}{8}x^3$
 (d) $f(x) = -(x+2)^2 + 3$ (e) $f(x) = \frac{2}{1-x}$ (f) $f(x) = 1 - \frac{1}{x+2}$
 (g) $f(x) = -(x-2)^3 - 2$ (h) $f(x) = \frac{1}{2(2-x)}$ (i) $f(x) = 4 - \frac{2}{x^2}$
 (j) $f(x) = 3 - \frac{2}{1-x}$ (k) $f(x) = -(1-x)^2$ (l) $f(x) = 4\sqrt{9-x}$
 (m) $f(x) = -\frac{2}{(2x-1)^2}$ (n) $f(x) = \frac{1}{2}\sqrt{2-\frac{1}{4}x}$ (o) $f(x) = |2-x|$
 (p) $f(x) = 2(1-\sqrt{x-2})$ (q) $f(x) = 4 - |8-x^3|$ (r) $f(x) = \frac{2}{2-\sqrt{x}}$

4. The graph of $y = f(x)$ is shown.

Use it to sketch the graphs of

- (a) $y = f(x-1)$ (b) $y = f(x)-1$
 (c) $y = f(x+1)$ (d) $y = 1-f(x)$
 (e) $y = 1+f(-x)$ (f) $y = 2-f(-x)$
 (g) $y = -\frac{1}{2}f(x)$ (h) $y = f(-2x)$
 (i) $y = 2-f\left(\frac{1}{2}x\right)$ (j) $y = -2+f(1-x)$

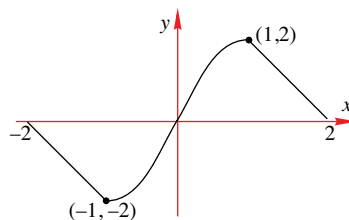

5. Sketch the graphs of the following functions relative to the graph of

- (a) $f(x) = \frac{1}{x}$ i. $y = f(ax) + b, a > 1, b < 0$
 ii. $y = bf(a-x), b > 0, a > 0$
 (b) $f(x) = \frac{1}{x^2}$ i. $y = bf(\sqrt{ax}) - a, a > 1, b < 0$
 ii. $y = f\left(\frac{x}{b}\right) - a, a > 0, b < 0$
 (c) $f(x) = \sqrt{x}$ i. $y = af(a^2 - ax), a > 0$
 ii. $y = af(a^2 - ax), a < 0$

6. Consider the following transformations

- A: Reflection about x -axis. B: Reflection about y -axis C: $\begin{pmatrix} 1 \\ 2 \end{pmatrix}$
 D: Squash by factor 2 along x -axis E: Stretch by factor 3 along y -axis

Sketch the graph of $f(x)$ under the transformations in their given order

- (a) $f(x) = |x-2|$, A; C. (b) $f(x) = |x-2|$, C; A.
 (c) $f(x) = |x^2-2x|$, D; B; C. (d) $f(x) = |x^2-2x|$, C; D; B.
 (e) $f(x) = x^3$, A; E; C. (f) $f(x) = x^3$, E; C; A.

6.4 RECIPROCAL OF A FUNCTION

In this section we sketch the graph of $y = \frac{1}{f(x)}$ based on the graph of $y = f(x)$. We make observations of the behaviour of $y = f(x)$ and its reciprocal – we use the TI-83 to begin.

Example 1: Graph of $y = f(x)$ and $y = \frac{1}{f(x)}$ where $f(x) = x$:

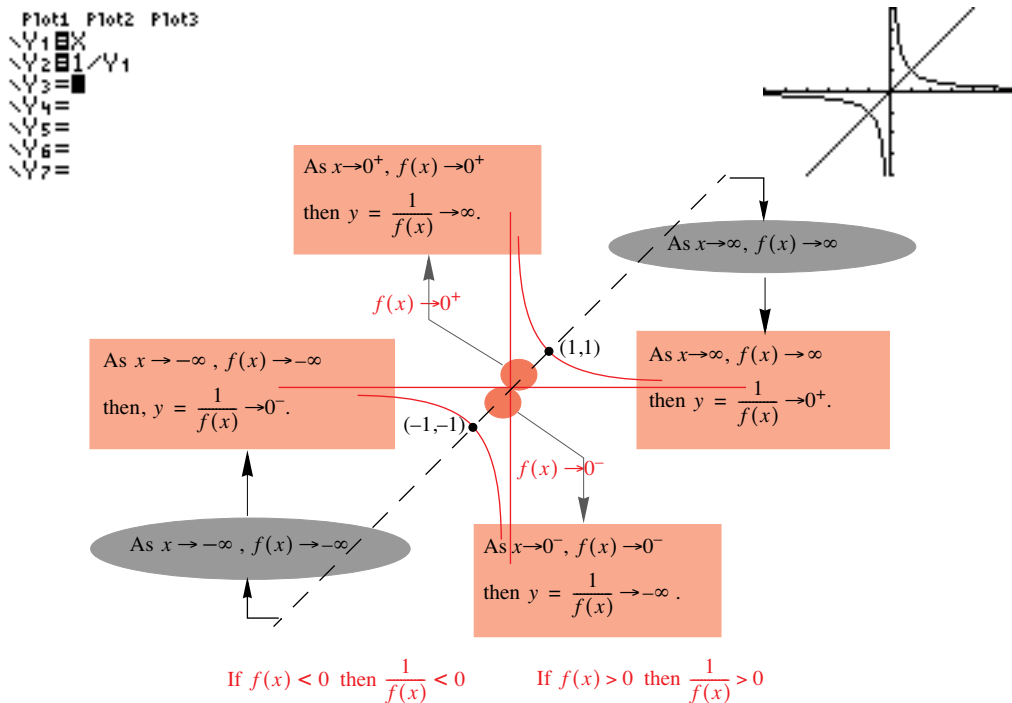

Example 2: Graph of $y = f(x)$ and $y = \frac{1}{f(x)}$ where $f(x) = x^2$:

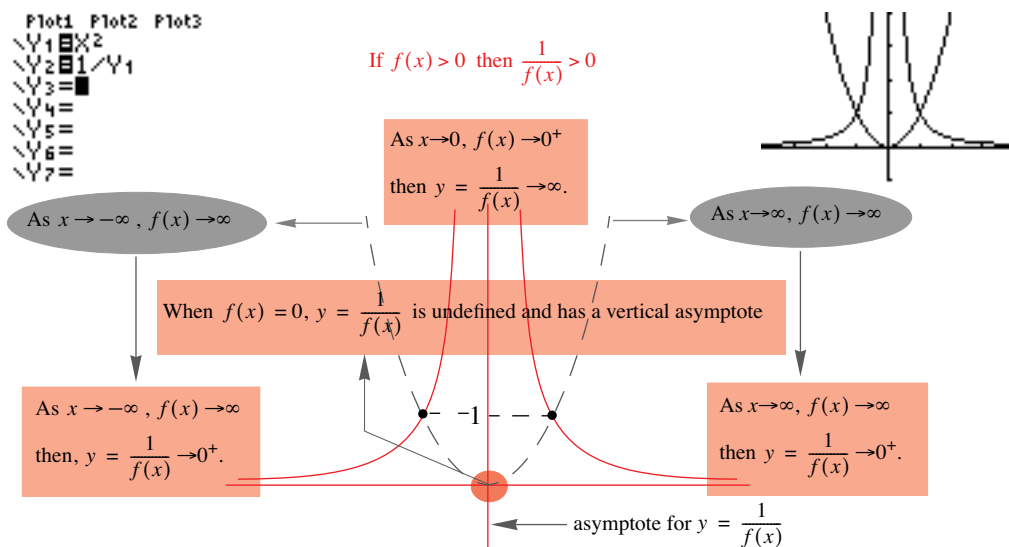

Examples 1 and 2 display some similar properties. Such properties will also exist in the examples that follow. Rather than listing all of the observations we now list selected observations.

Example 3: Graph of $y = f(x)$ and $y = \frac{1}{f(x)}$ where $f(x) = (x-2)(x+1)$:

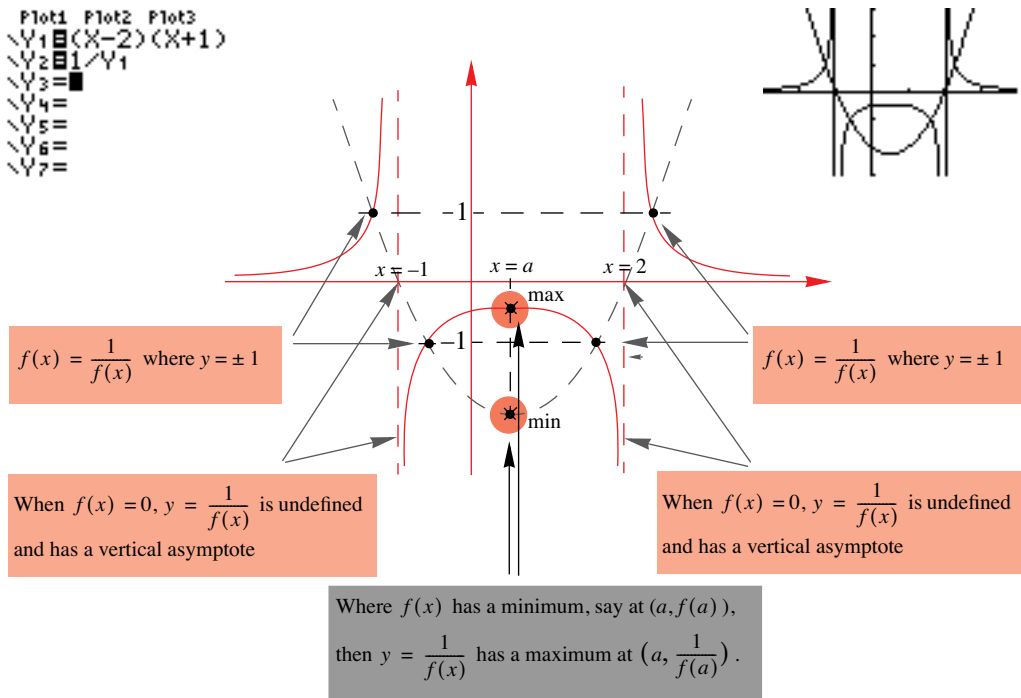

Example 4: Graph of $y = f(x)$ and $y = \frac{1}{f(x)}$ where $f(x) = \frac{1}{x} + 2$:

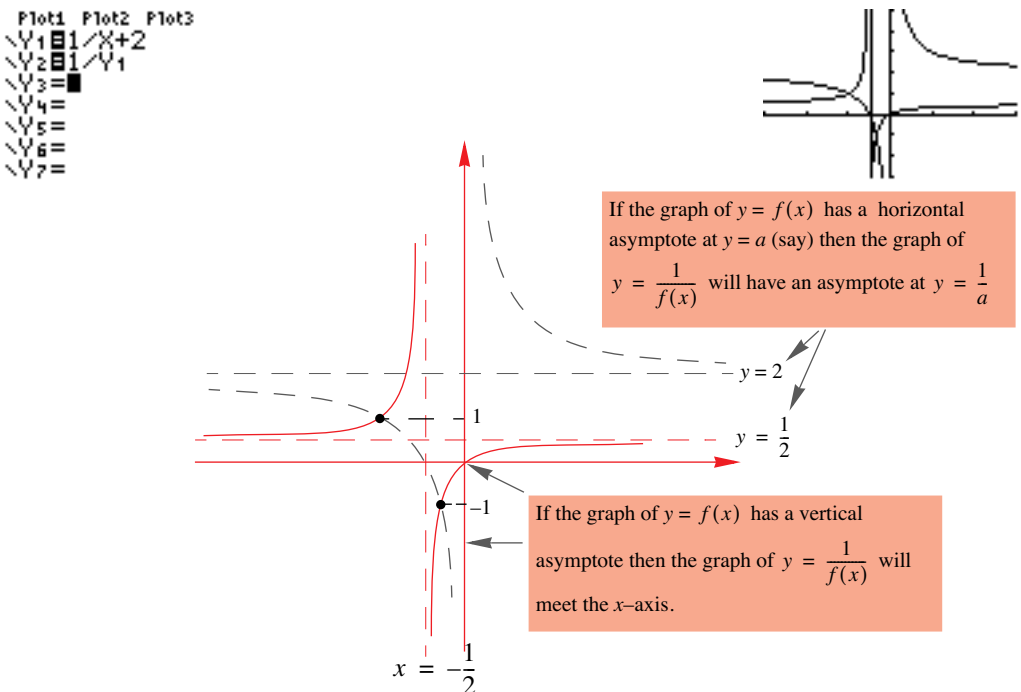

Example 5: Graph of $y = f(x)$ and $y = \frac{1}{f(x)}$ where $f(x) = (x-1)^3 + 2$:

```

Plot1 Plot2 Plot3
\Y1=(X-1)^3+2
\Y2=1/Y1
\Y3=
\Y4=
\Y5=
\Y6=
\Y7=
    
```



When $f(x) = 0$, $y = \frac{1}{f(x)}$ is undefined and has a vertical asymptote

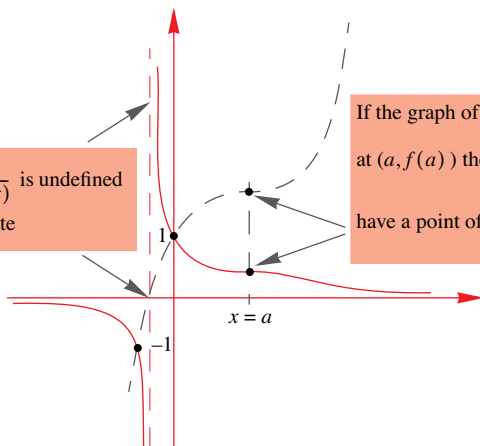

If the graph of $y = f(x)$ has a point of inflection at $(a, f(a))$ then the graph of $y = \frac{1}{f(x)}$ will have a point of inflection at $(a, \frac{1}{f(a)})$.

We summarise our observations as follows:

Observation 1:

If $f(x) > 0$ then $\frac{1}{f(x)} > 0$. If $f(x) < 0$ then $\frac{1}{f(x)} < 0$.

Geometrically:

Where the graph of $y = f(x)$ lies above the x -axis, so too does the graph of $y = \frac{1}{f(x)}$. Where the graph of $y = f(x)$ lies below the x -axis, so too does the graph of $y = \frac{1}{f(x)}$.

Observation 2:

Where $f(x) = 0$ then $\frac{1}{f(x)}$ is undefined.

Geometrically:

Where the graph of $y = f(x)$ cuts (or touches) the x -axis, the graph of $y = \frac{1}{f(x)}$ has a vertical asymptote.

Observation 3:

Where $f(x)$ is of the form $\frac{a}{0}$, $a \neq 0$ then $\frac{1}{f(x)} = 0$

Geometrically:

Where the graph of $y = f(x)$ has a vertical asymptote, the graph of $y = \frac{1}{f(x)}$ cuts (or touches) the x -axis.

Observation 4:

$$f(x) = \frac{1}{f(x)} \Leftrightarrow [f(x)]^2 = 1 \Leftrightarrow f(x) = \pm 1$$

Geometrically:

The graph of $y = f(x)$ and the graph of $y = \frac{1}{f(x)}$ intersect along the line $y = \pm 1$.

Observation 5:

If $f(x) \rightarrow a$ as $x \rightarrow \infty$ (or $x \rightarrow -\infty$) then $\frac{1}{f(x)} \rightarrow \frac{1}{a}$.

Geometrically:

If the graph of $y = f(x)$ has a horizontal asymptote at $y = a$, then the graph of $y = \frac{1}{f(x)}$ has a horizontal asymptote at $y = \frac{1}{a}$.

Observation 6:

As $|f(x)| \rightarrow \infty$, $\left|\frac{1}{f(x)}\right| \rightarrow 0$ and as $|f(x)| \rightarrow 0$, $\left|\frac{1}{f(x)}\right| \rightarrow \infty$.

Geometrically:

As the graph of $y = f(x)$ increases, the graph of $y = \frac{1}{f(x)}$ decreases.

As the graph of $y = f(x)$ decreases, the graph of $y = \frac{1}{f(x)}$ increases.

Observation 7:

If $y = f(x)$ has a stationary point at $x = a$ and $f(a) \neq 0$, then $y = \frac{1}{f(x)}$ also has a stationary point at $x = a$.

[A full discussion of stationary points is found in Chapter 20].

Geometrically:

1. If the graph of $y = f(x)$ has a maximum at $(a, f(a))$, then the graph of $y = \frac{1}{f(x)}$ has a minimum at $\left(a, \frac{1}{f(a)}\right)$.

2. If the graph of $y = f(x)$ has a minimum at $(a, f(a))$, then the graph of $y = \frac{1}{f(x)}$ has a maximum at $\left(a, \frac{1}{f(a)}\right)$.

3. If the graph of $y = f(x)$ has a point of inflection at $(a, f(a))$, then the graph of $y = \frac{1}{f(x)}$ has a point of inflection at $\left(a, \frac{1}{f(a)}\right)$.

The point of inflection can be either stationary or non-stationary.

Notice that we have not worked out the axial intercepts in the examples that were used to derive our observations, however, you should always find the coordinates of all axial intercepts.

EXAMPLE 6.13

Sketch the graph of $y = \frac{1}{f(x)}$ for each of the functions shown below.

(a)

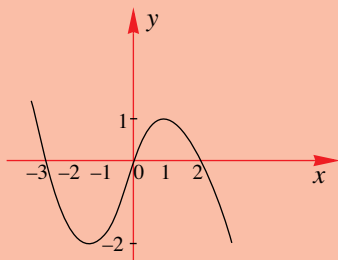

(b)

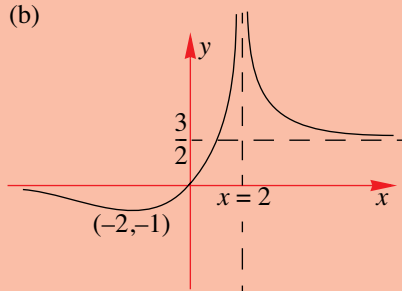

Solution

i(a) Using the observations made, we have:

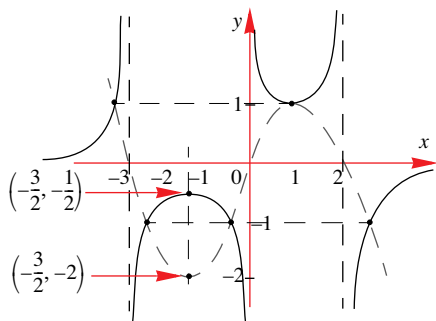

Based on observations 1–7, the graph of $y = \frac{1}{f(x)}$

has the following properties:

1. vertical asymptotes at $x = -3$, $x = 0$ and $x = 2$
2. (local) maximum at $(-\frac{3}{2}, -\frac{1}{2})$ and (local) minimum at $(1, 1)$.
3. horizontal asymptote at $y = 0$ (i.e., x -axis).

To determine the points of intersection between the two graphs we recall that the graphs will meet along the line $y = \pm 1$. This means we would need to solve two equations, $f(x) = 1$ and $f(x) = -1$. As we have no equations, we leave the graph above as is, noting that one point of intersection occurs at $(1, 1)$ while the other two occur in the domains $-1 < x < 0$ and $-3 < x < -1$.
(b)

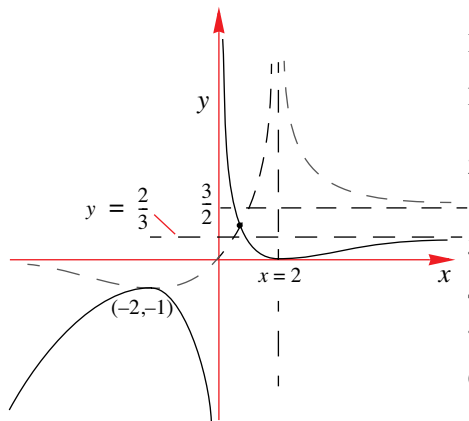

Based on observations 1–7, the graph of $y = \frac{1}{f(x)}$

has the following properties:

1. vertical asymptotes at $x = 0$.
2. (local) maximum at $(-2, -1)$ and (local) minimum at $(2, 0)$.
3. horizontal asymptote at $y = \frac{2}{3}$.
4. meets the x -axis at $(2, 0)$.
5. passes through the points $(1, 1)$ and $(-2, -1)$.
6. as $x \rightarrow -\infty$, $\frac{1}{f(x)} \rightarrow -\infty$.

So far we have considered sketching the graph of $y = \frac{1}{f(x)}$ based on the graph of $y = f(x)$, however, we could just as easily sketch the graph of $y = \frac{k}{f(x)}$ based on the graph of $y = f(x)$. The equation $y = \frac{k}{f(x)}$ can be rewritten as $y = k \times \frac{1}{f(x)}$ so that the factor ‘ k ’ represents a dilation of factor k along the y -axis. This means that once the graph of $y = \frac{1}{f(x)}$ is sketched, all that remains is to stretch (or shrink) it. If $k < 0$, we also reflect the graph about the x -axis.

EXAMPLE 6.14

Sketch the graphs of the following functions

- (a) $y = \frac{4}{x^2 - 2x}$ (b) $y = \frac{4}{x^2 - 2x + 5}$

In this example we sketch the results and then briefly comment on some observations.

(a)

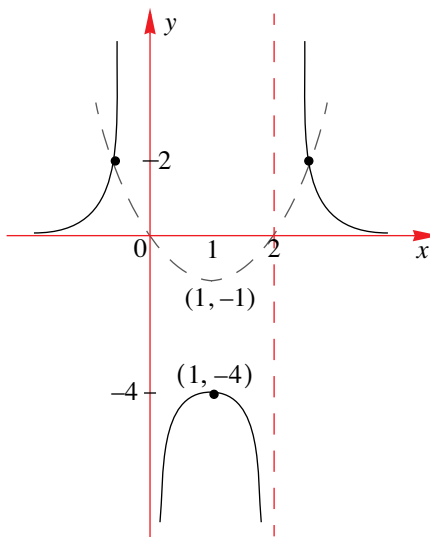

We first sketched the graph of $y = x^2 - 2x$, located where it cuts the x -axis ($x = 0$ and $x = 2$) and found its turning point $(1, -1)$. From this graph we could deduce the following properties for

$$y = \frac{1}{x^2 - 2x} :$$

1. place asymptotes at $x = 0$ and $x = 2$
2. have a turning point at $(1, -1)$. However, because of the factor of '4', the turning point would now be located at $(1, -4)$.

Note: To find where the graphs of $y = f(x)$ and $y = \frac{4}{f(x)}$ meet

$$\begin{aligned} \text{we need to solve } f(x) = \frac{4}{f(x)} &\Leftrightarrow (f(x))^2 = 4 \\ &\Leftrightarrow f(x) = \pm 2 \end{aligned}$$

3. as $f(x) \rightarrow \infty$, $\frac{4}{f(x)} \rightarrow 0^+$.
4. as $f(x) \rightarrow 0^+$, $\frac{4}{f(x)} \rightarrow \infty$ and as $f(x) \rightarrow 0^-$, $\frac{4}{f(x)} \rightarrow -\infty$.

(b)

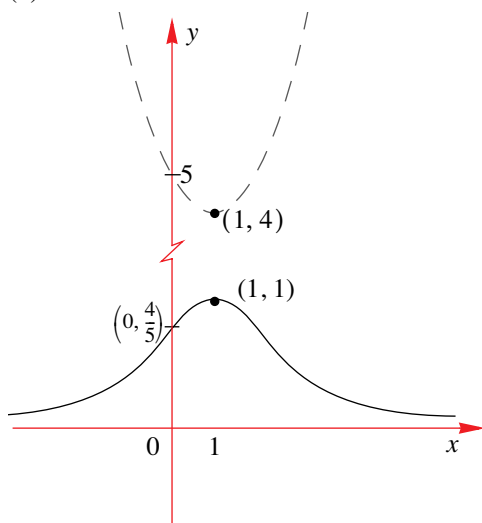

We note that

1. the graph of $f(x) = x^2 - 2x + 5$ lies above the x -axis, meaning that the graph of $y = \frac{4}{f(x)}$ will also lie above the x -axis.
2. as the graph of $y = f(x)$ has no x -intercepts, the graph of $y = \frac{4}{f(x)}$ has no vertical asymptotes.
3. the minimum of $y = f(x)$ is 4, therefore the maximum of $y = \frac{4}{f(x)} = \frac{4}{4} = 1$.
4. the graph of $y = f(x)$ cuts the y -axis at $y = 5$, so the graph of $y = \frac{4}{f(x)}$ will cut the y -axis at $y = \frac{4}{5}$.
5. as $f(x) \rightarrow \infty$, $\frac{4}{f(x)} \rightarrow 0^+$.

Two other 'transformations', involving the use of the absolute value function, namely, sketching the graph of $y = |f(x)|$ and $y = f(|x|)$ from the graph of $y = f(x)$ have already been dealt with in detail in Chapter 5.

Of course there are other types of graphs that can be sketched based on the graph of $y = f(x)$. For example, $y = \sqrt{f(x)}$, where, for example, we could only consider that part of $y = f(x)$ where $f(x) \geq 0$ or $y = [f(x)]^2$. We leave graphs such as these for the exercises.

EXERCISES 6.4

1. Sketch the graphs of $y = \frac{1}{f(x)}$ for each of the following

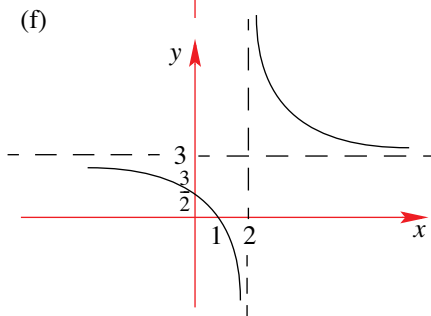
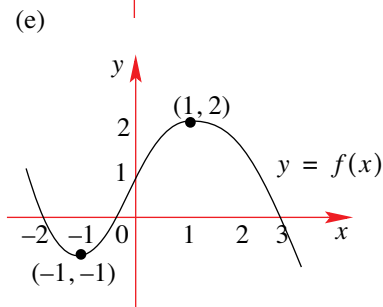
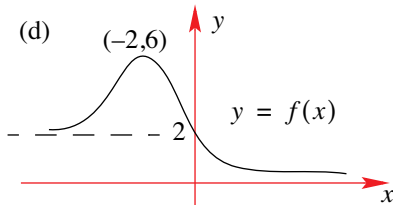
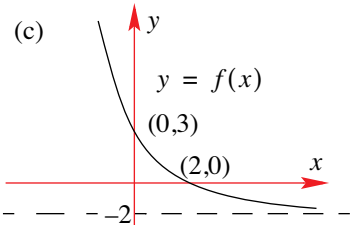
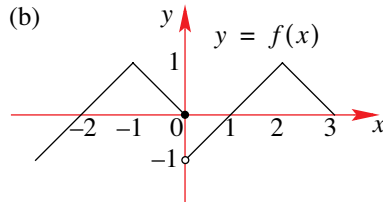
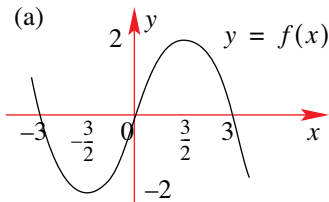

2. On the same set of axes sketch the graphs of $y = f(x)$ and $y = \frac{1}{f(x)}$ where

(a) $f(x) = \sqrt{x} - 2$

(b) $f(x) = x^2 + 4x$

(c) $f(x) = x^3 + 2$

(d) $f(x) = e^x - 1$

(e) $f(x) = \ln x$

(f) $f(x) = |x| - 1$

(g) $f(x) = (2 - x)^3$

(h) $f(x) = 2 - 2^x$

(i) $f(x) = \frac{x+1}{x}$

(j) $f(x) = \left| \frac{1}{x} - 2 \right|$

(k) $f(x) = \frac{1}{|x^2 - 4|}$

(l) $f(x) = \log_{10}(3 - x)$

3. (a) Sketch the graph of $f(x) = x^2 - 4x + 3$.

(b) Using your graph in part (a), sketch the graph of $y = \frac{1}{x-3} - \frac{1}{x-1}$

4. Sketch the graph of $f(x) = 2\left(\frac{1}{x-5} - \frac{1}{x-3}\right)$.

EXERCISES 6.5 - MISCELLANEOUS QUESTIONS

1. For the functions shown below sketch the graphs of

(a) $y = \frac{1}{f(x-1)}$

(b) $y = \frac{2}{f(x)}$

(c) $y = \frac{2}{f(2x)}$

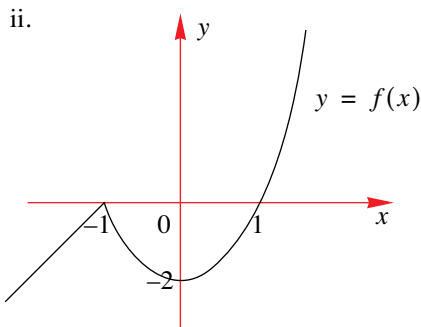
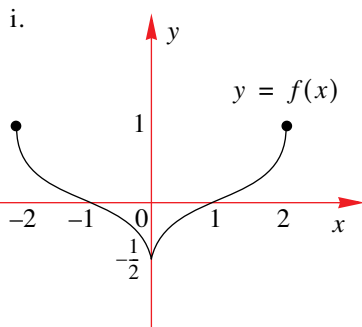

2. On the same set of axes sketch the graphs of

(a) $f(x) = x^2 - 6x + 8$ and $y = \frac{1}{f(x)}$.

(b) $f(x) = x^2 - 6x + 9$ and $y = \frac{1}{f(x)}$.

(c) $f(x) = x^2 - 6x + 10$ and $y = \frac{1}{f(x)}$.

(d) $f(x) = x^2 - 6x + 11$ and $y = \frac{2}{f(x)}$.

3. Consider the functions $f(x) = a^x, a > 1$ and $g(x) = a^{-x}, a > 1$.

(a) On the same set of axes sketch the graphs of $y = f(x)$ and $y = g(x)$.

(b) i. Sketch the graph of $y = f(x) + g(x)$.

ii. Sketch the graph of $y = f(x) - g(x)$.

Let $u(x) = a^x + a^{-x}, a > 1$ and $v(x) = a^x - a^{-x}, a > 1$.

(c) Sketch the graph of

i. $y = \frac{2}{u(x)}$

ii. $y = \frac{1}{v(x)}$

iii. $y = \frac{2}{u(|x|)}$

iv. $y = \frac{1}{v(|x|)}$

v. $y = \left| \frac{2}{u(x)} \right|$

vi. $y = \left| \frac{1}{v(x)} \right|$

- 4.** Consider the graph shown below

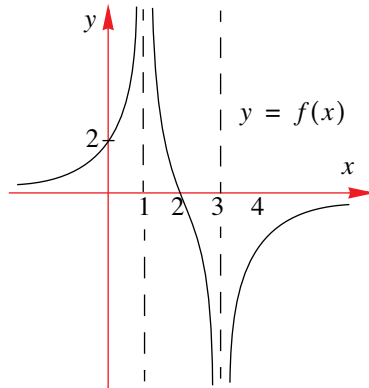

Sketch the graph of

i. $y = \frac{4}{f(x)}$ ii. $y = \frac{1}{f(|x|)}$ iii. $y = \frac{2}{|f(x)|}$

- 5.** Consider the function $u(x) = \begin{cases} x^2 - ax & \text{if } x \geq 0 \\ a - ae^x & \text{if } x < 0 \end{cases}$, where $a > 0$.

- (a) Sketch the graph of $y = u(x)$.
 (b) Sketch the graph of $y = \frac{a}{u(x)}$ for
 (c) If $v(x) = |x|$ sketch the graph of
 i. $y = (u \circ v)(x)$ ii. $y = -(v \circ u)(x)$.

- 6.** (a) Given that the curve $y = x^3 - 12x$ has turning points at $(2, -16)$ and $(-2, 16)$ sketch its graph.

- (b) Hence, sketch the graph of
 i. $y = \frac{12}{x^3 - 12x}$.
 ii. $y^2 = x^3 - 12x$.

- 7.** On the same set of axes sketch the graphs of $f(x) = \frac{1}{a} \log_a(x - a)$, $a > 1$ and $y = \frac{1}{f(x)}$.

- 8.** (a) On the same set of axes sketch the graphs of $f(x) = \frac{1}{a}x$ and $g(x) = \frac{a}{x}$, $a > 0$.

Hence sketch the graph of $y = \frac{x^2 + a^2}{ax}$, $a > 0, x \neq 0$.

- (b) Using your results from (a), sketch the graph of $h(x) = \frac{1}{f(x) + g(x)}$.

- (c) Hence, show that $-\frac{1}{2} \leq \frac{ax}{x^2 + a^2} \leq \frac{1}{2}$.

7.1 EXPONENTS

In §5.3.3 and §5.3.4 we looked at the exponential function, $f(x) = a^x$, $a > 0$ and the logarithmic function, $f(x) = \log_a x$, $a > 0$ and considered their general behaviour. In this chapter we will look in more detail at how to solve exponential and logarithmic equations as well as applications of both the exponential and logarithmic functions.

7.1.1 BASIC RULES OF INDICES

We start by looking at the notation involved when dealing with indices (or exponents). The expression

$$a \times a \times a \times \dots \times a$$

← n times →

can be written in index form, a^n , where n is the **index** (or power or **exponent**) and a is the **base**. This expression is read as “ a to the power of n .” or more briefly as “ a to the n ”.

For example, we have that $3^5 = 3 \times 3 \times 3 \times 3 \times 3$ so that 3 is the base and 5 the exponent (or index).

The laws for positive integral indices are summarised below.

If a and b are real numbers and m and n are positive integers, we have that

Law	Rule	Example
1. Multiplication [same base]	$a^m \times a^n = a^{m+n}$	$3^4 \times 3^6 = 3^{4+6} = 3^{10}$
2. Division [same base]	$a^m \div a^n = \frac{a^m}{a^n} = a^{m-n}$	$7^9 \div 7^5 = 7^{9-5} = 7^4$
3. Power of a power [same base]	$(a^m)^n = a^{m \times n}$	$(2^3)^5 = 2^{3 \times 5} = 2^{15}$
4. Power of a power [same power]	$a^m \times b^m = (ab)^m$	$3^4 \times 7^4 = (3 \times 7)^4 = 21^4$
5. Division [same power]	$a^m \div b^m = \frac{a^m}{b^m} = \left(\frac{a}{b}\right)^m$	$5^3 \div 7^3 = \left(\frac{5}{7}\right)^3$
6. Negative one to a power	$(-1)^n = \begin{cases} -1 & \text{if } n \text{ is odd} \\ 1 & \text{if } n \text{ is even} \end{cases}$	$(-1)^3 = (-1)^5 = \dots = -1$ $(-1)^2 = (-1)^4 = \dots = 1$

There are more laws of indices that are based on rational indices, negative indices and the zero index. A summary of these laws is provided next.

Law	Rule	Example
1. Fractional index Type 1 [nth root]	$a^{1/n} = \sqrt[n]{a}, n \in \mathbb{N}$. Note: if n is even, then $a \geq 0$. if n is odd, then $a \in \mathbb{R}$.	$8^{1/3} = \sqrt[3]{8} = 2$ $(-27)^{1/3} = \sqrt[3]{-27} = -3$
2. Fractional index Type 2	$a^{m/n} = \sqrt[n]{a^m}$ Note: if n is even, then $a^m \geq 0$ if n is odd, then $a \in \mathbb{R}$.	$16^{3/4} = \sqrt[4]{16^3} = 8$
3. Negative index	$a^{-1} = \frac{1}{a}, a \neq 0$ $a^{-n} = \frac{1}{a^n}, a \neq 0, n \in \mathbb{N}$	$2^{-1} = \frac{1}{2} = 0.5$ $3^{-2} = \frac{1}{3^2} = \frac{1}{9}$
4. Zero index	$a^0 = 1, a \neq 0$ Note: $0^n = 0, n \neq 0$	$12^0 = 1$

We make the following note about fractional indices:

As $\frac{m}{n} = m \times \frac{1}{n} = \frac{1}{n} \times m$, we have that for $b \geq 0$

i. $b^{\frac{m}{n}} = b^{m \times \frac{1}{n}} = (b^m)^{\frac{1}{n}} = \sqrt[n]{b^m}$

ii. $b^{\frac{m}{n}} = b^{\frac{1}{n} \times m} = \left(b^{\frac{1}{n}}\right)^m = (\sqrt[n]{b})^m$

Then, If $b \geq 0$, then $b^{\frac{m}{n}} = \sqrt[n]{b^m} = (\sqrt[n]{b})^m, m \in \mathbb{Z}, n \in \mathbb{N}$

If $b < 0$, then $b^{\frac{m}{n}} = \sqrt[n]{b^m} = (\sqrt[n]{b})^m, m \in \mathbb{Z}, n \in \{1, 3, 5, \dots\}$

EXAMPLE 7.1

Simplify the following

(a) $\left(\frac{4x^2}{5y^4}\right)^2 \times (2x^3y)^3$ (b) $\frac{3^{n+1} + 3^2}{3}$

S
O
L
V
E
D
E
D
E
D
E
D
E

(a) $\left(\frac{4x^2}{5y^4}\right)^2 \times (2x^3y)^3 = \frac{4^2 x^{2 \times 2}}{5^2 y^{4 \times 2}} \times 2^3 x^{3 \times 3} y^{1 \times 3}$ (b) $\frac{3^{n+1} + 3^2}{3} = \frac{3(3^n + 3)}{3}$

$= \frac{16x^4}{25y^8} \times 8x^9y^3$ $= 3^n + 3$

$= \frac{128}{25} x^{4+9} y^{3-8}$

$= \frac{128}{25} x^{13} y^{-5}$

$= \frac{128x^{13}}{25y^5}$

EXAMPLE 7.2

Simplify the following

(a) $\frac{4x^2(-y^{-1})^{-2}}{(-2x^2)^3(y^{-2})^2}$ (b) $\frac{x^{-1} + y^{-1}}{x^{-1}y^{-1}}$

**S
o
l
u
t
i
o
n**

(a)
$$\begin{aligned} \frac{4x^2(-y^{-1})^{-2}}{(-2x^2)^3(y^{-2})^2} &= \frac{4x^2 \times y^{-1 \times -2}}{-8x^{2 \times 3} \times y^{-2 \times 2}} = \frac{x^2y^2}{2x^6y^{-4}} \\ &= \frac{y^{2-(-4)}}{2x^{6-(2)}} \\ &= \frac{y^6}{2x^4} \end{aligned}$$

(b)
$$\begin{aligned} \frac{x^{-1} + y^{-1}}{x^{-1}y^{-1}} &= \frac{\frac{1}{x} + \frac{1}{y}}{\frac{1}{xy}} = \left(\frac{1}{x} + \frac{1}{y}\right) \times \frac{xy}{1} = \frac{xy}{x} + \frac{xy}{y} \\ &= y + x \end{aligned}$$

EXAMPLE 7.3

Simplify the following

(a) $\frac{2^{n-3} \times 8^{n+1}}{2^{2n-1} \times 4^{2-n}}$ (b) $\frac{(a^{1/3} \times b^{1/2})^{-6}}{\sqrt[4]{a^8b^9}}$

**S
o
l
u
t
i
o
n**

(a)
$$\begin{aligned} \frac{2^{n-3} \times 8^{n+1}}{2^{2n-1} \times 4^{2-n}} &= \frac{2^{n-3} \times (2^3)^{n+1}}{2^{2n-1} \times (2^2)^{2-n}} = \frac{2^{n-3} \times 2^{3n+3}}{2^{2n-1} \times 2^{4-2n}} \\ &= \frac{2^{n-3+(3n+3)}}{2^{2n-1+(4-2n)}} \\ &= \frac{2^{4n}}{2^3} \\ &= 2^{4n-3} \end{aligned}$$

(b)
$$\begin{aligned} \frac{(a^{1/3} \times b^{1/2})^{-6}}{\sqrt[4]{a^8b^9}} &= \frac{a^{\frac{1}{3} \times -6} \times b^{\frac{1}{2} \times -6}}{(a^8b^9)^{\frac{1}{4}}} = \frac{a^{-2} \times b^{-3}}{a^2b^{\frac{9}{4}}} \\ &= a^{-2-2} \times b^{-3-\frac{9}{4}} \\ &= a^{-4}b^{-\frac{21}{4}} \\ &= \frac{1}{a^4b^{\frac{21}{4}}} \end{aligned}$$

EXERCISES 7.1.1

1. Simplify the following

(a) $\left(\frac{3y^2}{4x^3}\right)^3 \times (2x^2y^3)^3$ (b) $\left(\frac{2}{3a^2}\right)^3 + \frac{1}{8a^6}$ (c) $\frac{2^{n+1} + 2^2}{2}$
 (d) $\left(\frac{2x^3}{3y^2}\right)^3 \times (xy^2)^2$ (e) $\left(\frac{2x^3}{4y^2}\right)^2 \times \frac{12y^6}{8x^4}$ (f) $\frac{3^{n+2} + 9}{3}$
 (g) $\frac{4^{n+2} - 16}{4}$ (h) $\frac{4^{n+2} - 16}{2}$ (i) $\left(\frac{1}{2b}\right)^4 - \frac{b^2}{16}$

2. Simplify the following

(a) $\frac{20^6}{10^6}$ (b) $\frac{12^{2x}}{(6^3)^x}$ (c) $\frac{16^{2y+1}}{8^{2y+1}}$
 (d) $\frac{(ab)^{2x}}{a^{2x}b^{4x}}$ (e) $\frac{(xy)^6}{64x^6}$ (f) $\frac{27^{n+2}}{6^{n+2}}$

3. Simplify the following

(a) $\left(\frac{x}{y}\right)^3 \times \left(\frac{y}{z}\right)^2 \times \left(\frac{z}{x}\right)^4$ (b) $3^{2n} \times 27 \times 243^{n-1}$ (c) $\frac{25^{2n} \times 5^{1-n}}{(5^2)^n}$
 (d) $\frac{9^n \times 3^{n+2}}{27^n}$ (e) $\frac{2^n \times 4^{2n+1}}{2^{1-n}}$ (f) $\frac{2^{2n+1} \times 4^{-n}}{(2^n)^3}$
 (g) $\frac{x^{4n+1}}{(x^n+1)^{(n-1)}}$ (h) $\frac{x^{4n^2+n}}{(x^n+1)^{(n-1)}}$ (i) $\frac{(3^x)(3^{x+1})(3^2)}{(3^x)^2}$

4. Simplify $\frac{(x^m)^n(y^2)^m}{(x^m)^{(n+1)}y^2}$.

5. Simplify the following, leaving your answer in positive power form

(a) $\frac{(-3^4) \times 3^{-2}}{(-3)^{-2}}$ (b) $\frac{9y^2(-x^{-1})^{-2}}{(-2y^2)^3(x^{-2})^3}$ (c) $\frac{x^{-1} - y^{-1}}{x^{-1}y^{-1}}$
 (d) $\frac{x^{-2} + 2x^{-1}}{x^{-1} + x^{-2}}$ (e) $\frac{(-2)^3 \times 2^{-3}}{(x^{-1})^2 \times x^2}$ (f) $\frac{(-a)^3 \times a^{-3}}{(b^{-1})^{-2}b^{-3}}$

6. Simplify the following

(a) $\frac{(x^{-1})^2 + (y^2)^{-1}}{x^2 + y^2}$ (b) $\frac{(x^2)^{-2} + 2y}{1 + 2yx^4}$ (c) $\frac{(x+h)^{-1} - x^{-1}}{h}$
 (d) $(x^2 - 1)^{-1} \times (x + 1)$ (e) $\frac{(x-1)^{-3}}{(x+1)^{-1}(x^2-1)^2}$ (f) $\frac{y(x^{-1})^2 + x^{-1}}{x+y}$

7. Simplify the following

(a) $5^{n+1} - 5^{n-1} - 2 \times 5^{n-2}$ (b) $a^{x-y} \times a^{y-z} \times a^{z-x}$ (c) $\left(\frac{a^{-\frac{1}{2}}b^3}{ab^{-1}}\right)^2 \times \frac{1}{ab}$

$$(d) \left(\frac{a^{m+n}}{a^n}\right)^m \times \left(\frac{a^{n-m}}{a^n}\right)^{m-n} \quad (e) \frac{p^{-2} - q^{-2}}{p^{-1} - q^{-1}} \quad (f) \frac{1}{1+a^{\frac{1}{2}}} - \frac{1}{1-a^{\frac{1}{2}}}$$

$$(g) \frac{2^{n+4} - 2(2^n)}{2(2^{n+3})} \quad (h) \sqrt{a\sqrt{a\sqrt{a}}}$$

8. Simplify the following

$$(a) \frac{\sqrt{x} \times \sqrt[3]{x^2}}{\sqrt[4]{x}} \quad (b) \frac{b^{n+1} \times 8a^{2n-1}}{(2b)^2(ab)^{-n+1}} \quad (c) \frac{2^n - 6^n}{1 - 3^n}$$

$$(d) \frac{7^{m+1} - 7^m}{7^n - 7^{n+2}} \quad (e) \frac{5^{2n+1} + 25^n}{5^{2n} + 5^{1+n}} \quad (f) \left(x - 2x^{\frac{1}{2}} + 1\right)^{\frac{1}{2}} \times \frac{x+1}{\sqrt{x}-1}$$

7.1.2 INDICIAL EQUATIONS

Solving equations of the form $x^{\frac{1}{2}} = 3$, where the **variable is the base**, requires that we square both sides of the equation so that $\left(x^{\frac{1}{2}}\right)^2 = 3^2 \Rightarrow x = 9$. However, when the **variable is the power** and not the base we need to take a different approach.

Indicial (exponential) equations take on the general form $b^x = a$, where the unknown (variable), x , is the power

Consider the case where we wish to solve for x given that $2^x = 8$.

In this case we need to think of a value of x so that when 2 is raised to the power of x the answer is 8. Using trial and error, it is not too difficult to arrive at $x = 3$ ($2^3 = 2 \times 2 \times 2 = 8$).

Next consider the equation $3^{x+1} = 27$.

Again, we need to find a number such that when 3 is raised to that number, the answer is 27. Here we have that $27 = 3^3$. Therefore we can rewrite the equation as $3^{x+1} = 3^3$.

As the base on both sides of the equality is the same we can then equate the powers, that is,

$$\begin{aligned} 3^{x+1} = 27 &\Leftrightarrow 3^{x+1} = 3^3 \\ &\Leftrightarrow x + 1 = 3 \\ &\Leftrightarrow x = 2 \end{aligned}$$

Such an approach can be used for a variety of equations. We summarise this process for simple exponential equations:

	Solve for x : $b^x = N$	Example: Solve $5^x = 625$
Step 1:	Express the number N in the form b^{number}	$625 = 5^4$
Step 2:	Write the equation $b^x = b^{\text{number}}$	$\therefore 5^x = 5^4$
Step 3:	Equate exponents, $x = \text{number}$	$\Leftrightarrow x = 4$

EXAMPLE 7.4

Solve the following

(a) $3^x = 81$

(b) $2 \times 5^u = 250$

(c) $2^x = \frac{1}{32}$

S
O
L
V
E
I
O
N

(a) $3^x = 81 \Leftrightarrow 3^x = 3^4$

$\Leftrightarrow x = 4$

(b) $2 \times 5^u = 250 \Leftrightarrow 5^u = 125$

$\Leftrightarrow 5^u = 5^3$

$\Leftrightarrow u = 3$

(c) $2^x = \frac{1}{32} \Leftrightarrow 2^x = \frac{1}{2^5}$

$\Leftrightarrow 2^x = 2^{-5}$

$\Leftrightarrow x = -5$

EXAMPLE 7.5

Find

(a) $\left\{x \mid \left(\frac{1}{2}\right)^x = 16\right\}$

(b) $\{x \mid 3^{x+1} = 3\sqrt{3}\}$

(c) $\{x \mid 4^{x-1} = 64\}$

S
O
L
V
E
I
O
N

(a) $\left(\frac{1}{2}\right)^x = 16 \Leftrightarrow (2^{-1})^x = 16$

$\Leftrightarrow 2^{-x} = 2^4$

$\Leftrightarrow -x = 4$

$\Leftrightarrow x = -4$

i.e., solution set is $\{-4\}$.

(b) $3^{x+1} = 3\sqrt{3} \Leftrightarrow 3^{x+1} = 3 \times 3^{1/2}$

$\Leftrightarrow 3^{x+1} = 3^{3/2}$

$\Leftrightarrow x+1 = \frac{3}{2}$

$\Leftrightarrow x = \frac{1}{2}$

i.e., solution set is $\{0.5\}$.

(c) $4^{x-1} = 64 \Leftrightarrow (2^2)^{x-1} = 2^6$

$\Leftrightarrow 2^{2x-2} = 2^6$

$\Leftrightarrow 2x-2 = 6$

$\Leftrightarrow 2x = 8$

$\Leftrightarrow x = 4$

i.e., solution set is $\{4\}$.

EXERCISES 7.1.2

1. Solve the following equations.

(a) $\{x \mid 4^x = 16\}$ (b) $\left\{x \mid 7^x = \frac{1}{49}\right\}$ (c) $\{x \mid 8^x = 4\}$

(d) $\{x \mid 3^x = 243\}$ (e) $\{x \mid 3^{x-2} = 81\}$ (f) $\left\{x \mid 4^x = \frac{1}{32}\right\}$

(g) $\{x \mid 3^{2x-4} = 1\}$ (h) $\{x \mid 4^{2x+1} = 128\}$ (i) $\{x \mid 27^x = 3\}$

2. Solve the following equations.

(a) $\{x \mid 7^{x+6} = 1\}$ (b) $\left\{x \mid 8^x = \frac{1}{4}\right\}$ (c) $\{x \mid 10^x = 0.001\}$

(d) $\{x \mid 9^x = 27\}$ (e) $\{x \mid 2^{4x-1} = 1\}$ (f) $\{x \mid 25^x = \sqrt{5}\}$

(g) $\left\{x \mid 16^x = \frac{1}{\sqrt{2}}\right\}$ (h) $\{x \mid 4^{-x} = 32\sqrt{2}\}$ (i) $\{x \mid 9^{-2x} = 243\}$

7.1.3 EQUATIONS OF THE FORM $bf(x) = bg(x)$.

This is an extension of the previous section, in that now we will consider exponential equations of the form $bf(x) = N$ where N can be expressed as a number having base b so that $N = bg(x)$.

Consider the equation $2^{x^2-1} = 8$. Our first step is to express 8 as 2^3 so that we can then write

$$2^{x^2-1} = 8 \Leftrightarrow 2^{x^2-1} = 2^3$$

Then, equating powers we have: $\Leftrightarrow x^2 - 1 = 3$

So that, $\Leftrightarrow x^2 - 4 = 0$

$$\Leftrightarrow (x-2)(x+2) = 0$$

$$\therefore x = 2 \text{ or } x = -2$$

Checking these values by substituting back into the original equation shows them to be correct.

i.e., when $x = 2$, L.H.S = $2^{2^2-1} = 2^{4-1} = 2^3 = 8 = \text{R.H.S}$

when $x = -2$, L.H.S = $2^{(-2)^2-1} = 2^{4-1} = 2^3 = 8 = \text{R.H.S}$

However, had the equation been, $2^{x^2-1} = 2^{5-x}$, then the solution would have been

$$2^{x^2-1} = 2^{5-x} \Leftrightarrow x^2 - 1 = 5 - x \text{ [equating powers]}$$

$$\Leftrightarrow x^2 + x - 6 = 0$$

$$\Leftrightarrow (x-2)(x+3) = 0$$

$$\therefore x = 2 \text{ or } x = -3$$

Again, we can check that these solutions satisfy the original equation.

The thing to note here is that the solution process has not altered. Rather than having one of the powers represented by a constant, we now have both powers containing the variable.

EXAMPLE 7.6

Find $\{x \mid 3^{x^2-5x+2} = 9^{x+1}\}$.

S
O
L
V
E
D
I
O
N

We need to first express the equation in the form $b^{f(x)} = b^{g(x)}$ where, in this case, $b = 3$:

$$3^{x^2-5x+2} = 9^{x+1} \Leftrightarrow 3^{x^2-5x+2} = (3^2)^{x+1}$$

$$\Leftrightarrow 3^{x^2-5x+2} = 3^{2x+2}$$

$$\Leftrightarrow x^2 - 5x + 2 = 2x + 2$$

$$\Leftrightarrow x^2 - 7x = 0$$

$$\Leftrightarrow x(x-7) = 0$$

$$\Leftrightarrow x = 0 \text{ or } x = 7$$

Again, checking our solutions we have, $x = 0$: L.H.S = $3^{0-0+2} = 9 = 9^{0+1} = \text{R.H.S}$

$x = 7$: L.H.S = $3^{7^2-5 \times 7+2} = 3^{16} = 9^{7+1} = \text{R.H.S}$

Therefore, the solution set is $\{0, 7\}$

We now have a more general statement for solving exponential equations:

$$b^{f(x)} = b^{g(x)} \Leftrightarrow f(x) = g(x), \text{ where } b > 0 \text{ and } b \neq 1.$$

It is important to realise that this will only be true if **the base is the same on both sides** of the equality sign.

EXERCISES 7.1.3

1. Solve the following for the unknown

(a) $9^{2x-1} = 3^{2x+5}$ (b) $4^{x+1} = 8^{2x-4}$ (c) $25^{2x+3} = 125^{x+1}$

(d) $2^{4x+1} = 4^{x+2}$ (e) $16^{2x-1} = 8^{2x+1}$ (f) $\sqrt{3} \times 27^{x+1} = 9^{2x+1}$

(g) $(\sqrt{3})^{x-1} = 9^{-x+2}$ (h) $8^x = \frac{1}{16^{x+1}}$ (i) $4^{x+2} \times 8^{x-1} = 2$

2. Solve for the unknown

(a) $8^{x+1} = \frac{1}{2^x}$ (b) $8^{x+1} = 2^{x^2-1}$ (c) $3^{x-1} = 3^{x^2-1}$

(d) $4^{x^2-7x+12} = 1$ (e) $6\sqrt{n^2-3n} = 36$ (f) $(5^x)^2 = 5^{x^2}$

3. Solve the following

(a) $(x^2 - x - 1)^{x^2} = x^2 - x - 1$

(b) $(x-2)^{x^2-x-12} = 1$

(c) $(3x-4)^{2x^2} = (3x-4)^{5x-2}$

(d) $|x|^{x^2-2x} = 1$

(e) $(x^2 + x - 57)^{3x^2+3} = (x^2 + x - 57)^{10x}$

7.1.4 WHAT IF THE BASE IS NOT THE SAME?

Consider the equation $2^x = 10$. It is not possible (at this stage) to express the number 10, in exponent form with a base of 2. This means that our previous methods will not work.

However, we could try a numerical or even graphical approach to this problem. Clearly the value of x must be somewhere in the range $[3,4]$ as $2^3 = 8$ and $2^4 = 16$. We explore this problem using the graphics calculator.

We begin by defining the two relevant equations,

$$y = 2^x \text{ and } y = 10.$$

Then we enter these functions using the equation editor screen:

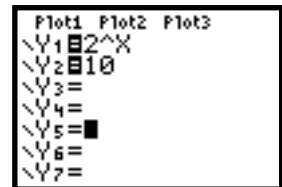

Next, we set our domain and range.

As we have already decided that $x \in [3, 4]$, we can set the domain to be $0 \leq x \leq 4$.

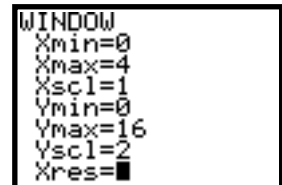

We can now obtain a graphical display of the equation $2^x = 10$.

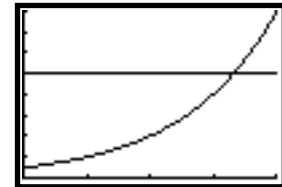

We can now find the point of intersection.

To do this we use the **CALC** menu and choose option **5: int** (this will determine the intersection of the two curves).

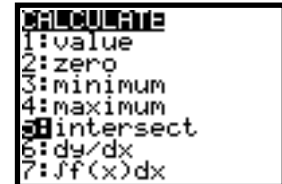

When asked for **First curve?** press **ENTER**. Similarly, for **Second curve?** When asked for **Guess?** move the cursor as close as possible to the point where both graphs meet and press **ENTER**.

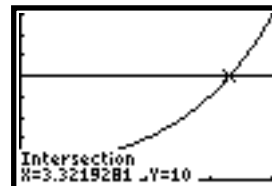
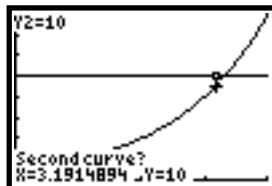
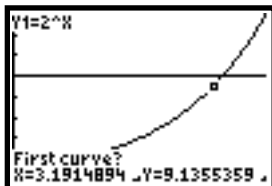

We have a solution (to four decimal places) for x , i.e., $x = 3.3219$. We could also have used the **ZOOM** facility to obtain the same result. We do this in the next example.

At this stage, the key to being able to solve equations of the form $a^x = b$ (where b cannot be easily expressed as a number having base ' a '), is to accurately sketch the graphs of $y = a^x$ and $y = b$, and then to determine where the two graphs meet.

EXAMPLE 7.7

Solve for x , $2^x = 12$

S
o
l
u
t
i
o
n

Let $y_1 = 2^x$ and $y_2 = 12$.

We enter the functions: $Y_1 = 2^X$

$Y_2 = 12$

Using the TI-83 to sketch the given graphs, we have:

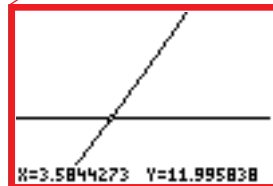
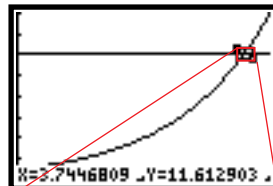
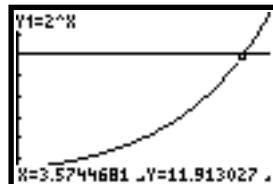

Using the **TRACE** key, we can move the cursor along the graph so that the square lies at the point where the two graphs meet. At this stage, our ‘best solution’ is $x = 3.57$

We can obtain a more accurate answer by using the **ZOOM** facility and then selecting **1:ZBOX** option (to ‘close-in’ on the point of intersection). Repeated use of the **Zoom** facility will continue to provide a more accurate solution.

After using the zoom facility once we have $x = 3.5844$ (The actual answer is $x = 3.5849\dots$).

Note: We can use the **0:solve** function on the TI-83, i.e., **solve** ($2^X-12,X,3$) = 3.5849...

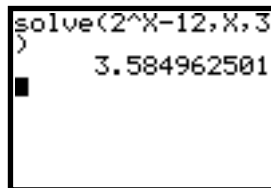

However, it is the graphical approach that we wish to emphasise at this stage, so that the relationship between the solution, the roots and the graphical representation can be clearly observed.

EXERCISES 7.1.4

1. Use a graphical approach to solve the following (give your answer correct to 2 d.p.).

- | | | | | | |
|--------|---|-----|-----------------------------------|------|-----------------------------------|
| (a) i. | $2^x = 40$ | ii. | $2^x = 1020$ | iii. | $2^x = 6$ |
| (b) i. | $3^x = 12$ | ii. | $3^x = 80$ | iii. | $3^x = 500$ |
| (c) i. | $\left(\frac{1}{2}\right)^x = \frac{1}{10}$ | ii. | $\left(\frac{1}{2}\right)^x = 20$ | iii. | $\left(\frac{1}{2}\right)^x = 80$ |
| (d) i. | $5^x = 0.1$ | ii. | $5^x = 15$ | iii. | $5^x = 0.01$ |

2. Use a graphical approach to solve the following (give your answer correct to 2 d.p.).

- | | | | |
|-----|-------------------------------|-----|----------------------------------|
| (a) | $\{x \mid 2^x = 1 - x\}$ | (b) | $\{x \mid 2^x = -x + 2\}$ |
| (c) | $\{x \mid 2^{-x} = 4x + 2\}$ | (d) | $\{x \mid 3^x = 1 - x^2\}$ |
| (e) | $\{x \mid 3^{-x} = x^2 - 1\}$ | (f) | $\{x \mid 5^x = 2 - (x - 1)^2\}$ |

7.1.5 A SPECIAL BASE (e)

Of all the expressions a^x , that for which $a = e$ is known as **the exponential function**. The exponential function is also known as the natural exponential function, in recognition of the important role that the value ' e ' has. The importance of ' e ' is that it occurs in many applications that arise as a result of natural phenomena. The question then remains; **What is ' e '?**

We consider how an investment can earn continuously compounded interest:

If a principal amount $\$P$ is invested at an annual percentage rate r , compounded once a year, the amount in the balance, $\$A$, after one year is given by $A = P + P \times r = P(1 + r)$. We can then have more frequent (quarterly, monthly, daily) compounding interest.

For example, if we have quarterly compounding interest then each quarter will have an effective rate of $\frac{r}{4}$, which will be compounded 4 times. This means that by the end of the year, the balance

will be given by $A = \left(1 + \frac{r}{4}\right)^4$.

If we next consider the situation where there are n compoundings per year, so that the rate per compounding becomes $\frac{r}{n}$, we then have that the amount in the balance after a year (i.e., after n

compoundings) is given by $A = \left(1 + \frac{r}{n}\right)^n$.

If we allow the number of compoundings n , to increase without bound, we obtain what is known as continuous compounding. We can set up a table of values for the case when $r = 1$.

n	$\left(1 + \frac{1}{n}\right)^n$
1	$\left(1 + \frac{1}{1}\right)^1 = 2$
10	$\left(1 + \frac{1}{10}\right)^{10} = 2.593742\dots$
100	$\left(1 + \frac{1}{100}\right)^{100} = 2.704813\dots$
1000	$\left(1 + \frac{1}{1000}\right)^{1000} = 2.716923\dots$
10 000	$\left(1 + \frac{1}{10000}\right)^{10000} = 2.718145\dots$

From the table of values, we have that as the value of n increases, the value of $\left(1 + \frac{1}{n}\right)^n$ approaches a fixed number. This number is given by 2.718145... , which happens to be an approximate value for the number ' e '.

MATHEMATICS – Higher Level (Core)

That is,

$$\lim_{n \rightarrow \infty} \left(1 + \frac{1}{n}\right)^n = e = 2.71828\dots$$

This limiting expression is also known as **Euler's number**.

This means that the natural base, e , is an irrational number just as the number π is. Notice then, the number e can be used in the same way that π is used in calculations.

EXAMPLE 7.8

Evaluate the following to 4 decimal places

(a) e^2 (b) \sqrt{e} (c) $e^3 - 2$

S
O
L
I
T
I
O
N

Remember, treat 'e' as you would any other number.

(a) $e^2 = 7.3891$

(b) $\sqrt{e} = 1.6487$

(c) $e^3 - 2 = 18.0855$

```
e^(2) 7.389056099
√(e^(1)) 1.648721271
e^(3)-2 18.08553692
```

EXAMPLE 7.9

Solve the following

(a) $e^{2x} = e$ (b) $e^{2x-3} = \frac{1}{e}$ (c) $e^{x^2-1} = e^{3x-3}$

S
O
L
I
T
I
O
N

(a) $e^{2x} = e \Leftrightarrow e^{2x} = e^1 \Leftrightarrow 2x = 1$
 $\Leftrightarrow x = \frac{1}{2}$

(b) $e^{2x-3} = \frac{1}{e} \Leftrightarrow e^{2x-3} = e^{-1} \Leftrightarrow 2x-3 = -1$
 $\Leftrightarrow 2x = 2$
 $\Leftrightarrow x = 1$

(c) $e^{x^2-1} = e^{3x-3} \Leftrightarrow x^2-1 = 3x-3$
 $\Leftrightarrow x^2-3x+2 = 0$
 $\Leftrightarrow (x-1)(x-2) = 0$
 $\Leftrightarrow x = 1 \text{ or } x = 2$

EXERCISES 7.1.5

1. Solve for x

(a) $e^x = e^2$ (b) $e^x = \frac{1}{e}$ (c) $e^x = \sqrt{e}$ (d) $e^{-2x} = \frac{1}{e}$

2. Solve for x

$$(a) \quad e^{2x} = e^{3-x} \quad (b) \quad e^{2+x} = e^{5-4x} \quad (c) \quad \frac{1}{e^{3x+1}} = e^{2x-1}$$

3. Solve for x

$$(a) \quad (e^x)^2 = e^x \quad (b) \quad (e^x)^2 = \sqrt{e^{x+2}}$$

4. Solve for x

$$(a) \quad e^{x^2-x} = e^2 \quad (b) \quad e^{x^2-x} = e^6 \quad (c) \quad e^{x^2+3x-1} = e^{x-2}$$

$$(d) \quad e^{x^2+4x} = e^{6-x} \quad (e) \quad \left(\frac{1}{e}\right)^x = e^{-x^2} \quad (f) \quad e^{-x+2} = e^{\frac{1}{x}}$$

5. Solve for x , giving your answer correct to 4 decimal places

$$(a) \quad e^x = 4 \quad (b) \quad e^x = 9 \quad (c) \quad e^x = 25 \quad (d) \quad e^x = -4$$

6. Solve for x , giving your answer correct to 4 decimal places

$$(a) \quad 3e^{2x} = 7 \quad (b) \quad 4e^{2x} = 9 \quad (c) \quad 2e^{3x} = 5 \quad (d) \quad 7e^{3x} = 2$$

7. Solve for x , giving your answer correct to 4 decimal places

$$(a) \quad e^x = -x + 1 \quad (b) \quad 2e^x = -3x - 1 \quad (c) \quad e^x = x + 1$$

8. (a) Show that if $e^{2x} + 6 = 5e^x$ then $e^x = 3$ or $e^x = 2$.

(b) Show that if $e^{2x} - 5e^x = 6$ then $e^x = 6$.

9. The graph of the function $f(x) = a \times 2^x + b$ is shown alongside.

Find the value of $f(3)$.

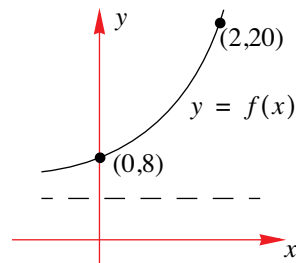

10. Find the values of a and k if the graph with equation $f(x) = ae^{-kx}$ passes through the points $(1, e)$ and $(-1, 2e)$.

7.2 EXPONENTIAL MODELLING

There are many situations and examples where an exponential function is an appropriate function to model a particular **growth** or **decay** process. For example:

1. When looking at the bacteria count of an experiment, the growth in the number of bacteria present in the colony is accurately represented by an exponential growth model.

If there are initially 100 bacteria in a colony and the size doubles every day, we model this situation by making use of the exponential function,

$$f: [0, a[\rightarrow \mathbb{R}, \text{ where } f(t) = 100 \times 2^t, a \in \mathbb{R}.$$

MATHEMATICS – Higher Level (Core)

The graph of such a model is given below.

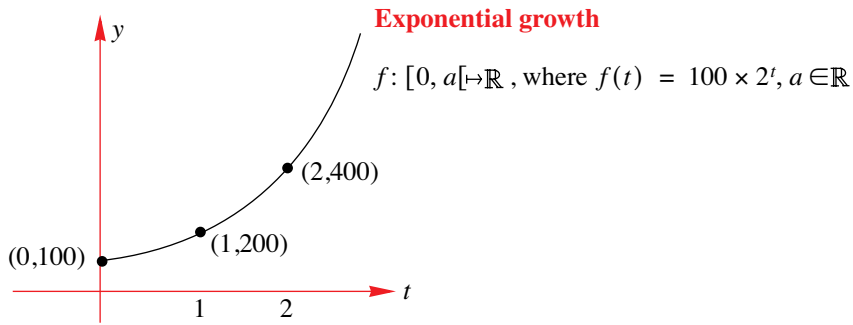

- 2.** Certain physical quantities decrease exponentially, for example, the decay of a radioactive substance, or isotope. Associated with this is the half-life, that is, the time that it takes for the substance to decay to one half of its original amount.

A radioactive bismuth isotope has a half-life of 5 days. If there is 100 milligrams initially, then we can model this situation by making use of the exponential function,

$$f: [0, \infty) \mapsto \mathbb{R}, \text{ where } f(t) = 100 \times \left(\frac{1}{2}\right)^{t/5}$$

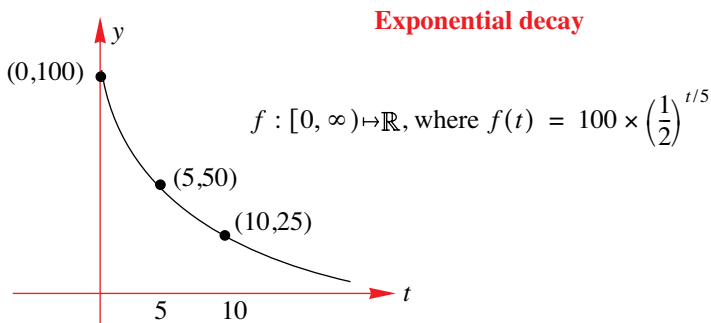

Other areas where the use of exponential modelling appears include, medicine (drug dosage), economics (compound interest), oceanography (light penetration in an ocean), environment (endangered species) and many more. We shall look at a few examples of exponential modelling in detail.

Notice that whenever making use of an exponential function to model a real life situation, the domain of consideration is always restricted to $[0, \infty)$. Corresponding to time, $t = 0$ (or $x = 0$), there exists an initial amount. This initial amount is usually denoted by a capital letter with a subscript of '0'. For example, if we are referring to the population size of bacteria, N or the number of radioactive particles P , then their initial amounts would be represented by N_0 and P_0 respectively, so that when $t = 0$, $N = N_0$ and $P = P_0$

Such equations would then be given by

1. $N = N_0 \times a^t, t \geq 0, a > 1$ [growth]

2. $P = P_0 \times a^{-t}, t \geq 0, a > 1$ [decay]

EXAMPLE 7.10

During the chemical processing of a particular type of mineral, the amount M kg of the mineral present at time t hours since the process started, is given by

$$M(t) = M_0(2)^{kt}, t \geq 0, k < 0$$

where M_0 is the original amount of mineral present. If 128 kilograms of the mineral are reduced to 32 kilograms in the first six hours of the process find,

- (a) i. the value of k .
- ii. the quantity of the mineral that remains after 10 hours of processing.
- (b) Sketch a graph of the amount of mineral present at time t hours after the process started.

S
o
l
u
t
i
o
n

- (a) i. We have that when $t = 0, M = 128 \Rightarrow M_0 = 128$ (the initial amount of mineral). The equation then becomes

$$M(t) = 128 \times (2)^{kt}, t \geq 0, k < 0.$$

Next, when $t = 6, M = 32$, so that when we substitute this information into the

equation, we have, $32 = 128 \times (2)^{6k} \Leftrightarrow 2^{6k} = \frac{1}{4}$

$$\Leftrightarrow 2^{6k} = 2^{-2}$$

$$\Leftrightarrow 6k = -2$$

$$\Leftrightarrow k = -\frac{1}{3}$$

Therefore, the equation is given by, $M(t) = 128 \times (2)^{-\frac{1}{3}t}, t \geq 0$

- ii. After 10 hours, we have, $M(10) = 128 \times (2)^{-\frac{1}{3} \times 10}$
 $= 12.699$

That is, there is approximately 12.70 kg of mineral left after 10 hours of processing.

- (b) We notice that the equation is of the form $f : [0, \infty) \rightarrow \mathbb{R}$, where $f(t) = a^{-x}, a > 1$ i.e., an exponential decay.

Hence, we have a decreasing function:

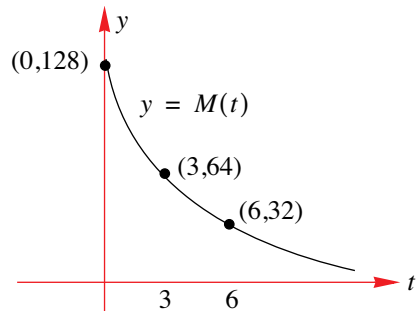

EXAMPLE 7.11

The scrap value, \$ V , of some machinery after t years is given by

$$V(t) = 50000(0.58)^t, t \geq 0.$$

- (a) What was the initial cost of the machine?
- (b) What is the scrap value of the machine after 4 years?
- (c) How long would it be before the scrap value reaches \$20000?
- (d) The machine needs to be sold at some time when the scrap value of the machine lies somewhere between 10000 and 15000. What time-frame does the owner have?

S
o
l
u
t
i
o
n

(a) When $t = 0$, we have $V(0) = 50000(0.58)^0 = 50000$.

That is, the machine initially cost \$50000.

(b) After 4 years, we have $V(4) = 50000(0.58)^4 = 5658.25$

That is, after 4 years, the scrap value of the machine would be \$5658.25.

(c) We need to determine the value of t when $V = 20000$:

$$20000 = 50000(0.58)^t \Leftrightarrow 0.4 = 0.58^t$$

Then, using the TI-83 we have (using the solve facility):

That is, $t = 1.68$ (to 2 d.p)

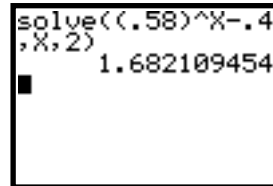

(d) This time we want to solve for t where $10000 \leq V(t) \leq 15000$.

$$\text{Now, } 10000 \leq V(t) \leq 15000 \Leftrightarrow 10000 \leq 50000(0.58)^t \leq 15000$$

$$\Leftrightarrow 0.2 \leq (0.58)^t \leq 0.3$$

Solving the corresponding equalities, we have:

$$\text{Giving } 2.21 \leq t \leq 2.95$$

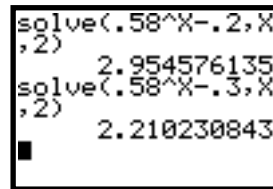

Notice that the graph helped in guessing the values of t that were used in determining the solutions.

Using the TI-83, we can easily sketch the graph of $y = (0.58)^t, t \geq 0$:

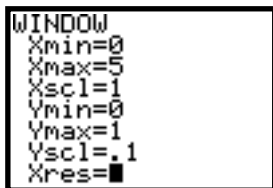
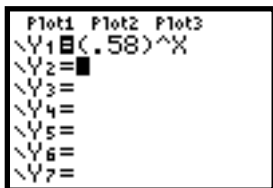

EXERCISES 7.2

1. The number of bacteria in a culture, N , is modelled by the exponential function

$$N = 1000 \times 2^{0.2t}, t \geq 0$$

where t is measured in days.

- (a) Find the initial number of bacteria in this culture.
- (b) Find the number of bacteria after
 - i. 3 days.
 - ii. 5 days.
- (c) How long does it takes for the number of bacteria to grow to 4000?

2. The ‘growth’ of crystals, measured in kilograms, in a chemical solution, has been approximately modelled by the exponential function $W = 2 \times 10^{kt}, t \geq 0$, where W is measured in kilograms and t in years. After 1 year in a chemical solution, the amount of crystal in the chemical increased by 6 grams.

- (a) Find the value of k .
- (b) Find the amount of crystal in the chemical solution after 10 years.
- (c) How long does it takes for this crystal to double in ‘size’?
- (d) Sketch the graph showing the amount of crystal in the chemical solution at time t .

3. It is found that the intensity of light decreases as it passes through water. The intensity I units at a depth x metres from the surface is given by

$$I = I_0(10)^{-kx}, x \geq 0$$

where I_0 units is the intensity at the surface.

Based on recordings taken by a diving team, it was found that $I = 0.2I_0$ at a depth of 50 metres.

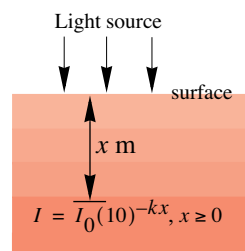

- (a) Find the value of k (to 5 d.p.).
- (b) Find the percentage of light remaining at a depth of 20 metres.
- (c) How much further would the divers need to descend, to reach a level at which the intensity of light would be given by $I = 0.1I_0$?
- (d) Find the depth at which the intensity would be a half of that at the surface.
- (e) Sketch the graph representing the intensity of light at a depth of x metres.
4. An endangered species of animal is placed into a game reserve. 150 such animals have been introduced into this reserve. The number of animals, $N(t)$, alive t years after being placed in this reserve is predicted by the exponential growth model $N(t) = 150 \times 1.05^t$.
- (a) Find the number of animals that are alive after
i. 1 year ii. 2 years iii. 5 years
- (b) How long will it take for the population to double?
- (c) How long is it before there are 400 of this species in the reserve?
- (d) Sketch a graph depicting the population size of the herd over time.
Is this a realistic model?
5. The processing of a type of mineral in a chemical solution has been found to reduce the amount of that mineral left in the solution. Using this chemical process, the amount W kg of the mineral left in the solution at time t hours is modelled by the exponential decay function $W = W_0 \times 10^{-kt}$, where W_0 kg is the original amount of mineral. It is found that 50 kilograms of mineral are reduced to 30 kilograms in 10 hours.
- (a) Write down the value of W_0 .
- (b) Find the value of k (to 4 decimal places).
- (c) How much of the mineral will be in the solution after 20 hours?
- (d) Sketch the graph representing the amount of mineral *left* in the solution.
- (e) Sketch the graph representing the amount by which the mineral is *reduced*.
6. The temperatures of distant dying stars have been modelled by exponential decay functions. A distant star known to have an initial surface temperature of 15000°C , is losing heat according to the function $T = T_0 \times 10^{-0.1t}$, where T_0 $^\circ\text{C}$ is its present temperature, and T $^\circ\text{C}$ the temperature at time t (in millions of years).
- (a) Determine the value of T_0 .
- (b) Find the temperature of this star in
i. one million years,
ii. 10 million years.
- (c) How long will it be before the star reaches a temperature that is half its original surface temperature?
- (d) Sketch a graph representing this situation.

MATHEMATICS – Higher Level (Core)

- 7.** The amount of radioactive material, Q grams, decays according to the model given by the equation $Q = 200 \times 10^{-kt}$, $t \geq 0$, where t is measured in years. It is known that after 40 years, the amount of radioactive material present is 50 grams.
- Find the value of k (to 4 d.p.).
 - Find the amount of radioactive material present after 80 years.
 - What is the half life for this radioactive substance? *The half-life is the time taken for the radioactive material to reach half its original amount.*
 - Sketch the graph representing the amount of radioactive material present as a function of time, t years.
- 8.** The resale value, V dollars, of a structure, decreases according to the function
- $$V = 2000000(10)^{-0.01t}, t \geq 0$$
- where t is the number of years since the structure was built.
- How much would the structure have sold for upon completion?
 - How much would the structure have sold for 10 years after completion?
 - How long will it take for the structure to lose half its value? (Answer to 1 d.p)
 - Sketch the graph of the structure's value since completion.
- 9.** The population number N in a small town in northern India is approximately modelled by the equation $N = N_0 \times 10^{kt}$, $t \geq 0$, where N_0 is the initial population and t is the time in years since 1980.
- The population was found to increase from 100,000 in 1980 to 150,000 in 1990.
- Show that $N_0 = 100000$ and that $1.5 = 10^{10k}$.
 - Hence find the value of k (to 5 d.p.).
 - Find the population in this town in 1997.
 - How long (since 1980) will it be before the population reaches 250,000?
- 10.** The healing process of certain types of wounds is measured by the decrease in the surface area that the wound occupies on the skin. A certain skin wound has its surface area modelled by the equation $S = 20 \times 2^{-0.01t}$, $t \geq 0$ where S square centimetres is the unhealed area t days after the skin received the wound.
- What area did the wound originally cover?
 - What area will the wound occupy after 2 days?
 - How long will it be before the wound area is reduced by 50%?
 - How long will it be before the wound area is reduced by 90%?
- 11.** In a certain city the number of inhabitants, N , at time t years since the 1st of January 1970, is modelled by the equation $N = 120000(1.04)^{kt}$, $t \geq 0$, $k > 0$.
- On the 1st of January 1980, the inhabitants numbered 177629.
- Determine the value of k .
 - How many people will be living in this city by
 - 1st January 2007?
 - 1st April 2007?
 - How long will it take for the population to reach 1000000?
- 12.** Suppose you deposited \$700 into an account that pays 5.80% interest per annum.
- How much money will you have in the account at the end of 5 years if
 - the interest is compounded quarterly?
 - the interest is compounded continuously?
 - With continuous compounding, how long will it take to double your money?
 - Sketch the graph showing the amount of money in the account for (b).

- 13.** On the 1st of January 1988, a number of antelopes were introduced into a wildlife reservation, free of predators. Over the years, the number of antelopes in the reservation was recorded:

Date (day/month/year)	1/1/88	1/1/90	1/6/94	1/1/98	1/6/02	1/6/04
Number of antelopes	–	120	190	260	400	485

Although the exact number of antelopes that were placed in the reserve was not available, it is thought that an exponential function would provide a good model for the number of antelopes present in the reserve.

Assume an exponential growth model of the form $N = N_0 \times 2^{kt}$, $t \geq 0$, $k > 0$, where N represents the number of antelopes present at time t years since 1/1/80, an N_0 is the initial population size of the herd, and k is a positive real constant.

- Determine the number of antelopes introduced into the reserve.
 - Determine the equation that best models this situation.
 - Based on this model, predict the number of antelopes that will be present in the reserve by the year 2008.
- 14.** Betty, the mathematician, has a young baby who was recently ill with fever. Betty noticed that the baby's temperature, T , was increasing linearly, until an hour after being given a dose of penicillin. It peaked, then decreased very quickly, possibly exponentially.

Betty approximated the baby's temperature, above 37°C by the function

$$T(t) = t \times 0.82^t, t \geq 0$$

where t refers to the time in hours after 7.00pm.

- Sketch the graph of $T(t)$.
 - Determine the maximum temperature and the time when this occurred (giving your answer correct to to 2 d.p)
- 15.** An equation of the form $N(t) = \frac{a}{1 + be^{-ct}}$, $t \geq 0$, where a , b and c are positive constants represents a logistic curve. Logistic curves have been found useful when describing a population N that initially grows rapidly, but whose growth rate decreases after t reaches a certain value.
- A study of the growth of protozoa was found to display these characteristics. It was found that the population was well described if $c = 1.12$, $a = 100$, and t measured time in days.
- If the initial population was 5 protozoa, find the value of b .
 - It was found that the growth rate was a maximum when the population size reached 50. How long did it take for this to occur ?
 - Determine the optimum population size for the protozoa.
- 16.** The height of some particular types of trees can be approximately modelled by the logistic function $h = \frac{36}{1 + 200e^{-0.2t}}$, $t \geq 0$ where h is the height of the tree measured in metres and t the age of the tree (in years) since it was planted.

- Determine the height of the tree when planted.
- By how much will the tree have grown in the first year ?
- How tall will the tree be after 10 years ?
- How tall will it be after 100 years ?

MATHEMATICS – Higher Level (Core)

- (e) How long will it take for the tree to grow to a height of
 - i. 10 metres ?
 - ii. 20 metres ?
 - iii. 30 metres ?
- (f) What is the maximum height that a tree, whose height is modelled by this equation, will reach? Explain your answer.
- (g) Sketch a graph representing the height of trees against time for trees whose height can be modelled by the above function.

- 17.** Certain prescription drugs, e.g. tablets that are taken orally, which enter the bloodstream at a rate R , are approximately modelled by the equation $R = a \times b^t, t \geq 0$ where t is measured in minutes and a and b are appropriate constants.

When an adult is administered a 100-milligram tablet, the rate is modelled by the function $R = 5 \times 0.95^t, t \geq 0$ mg/min.

The amount A mg of the drug in the bloodstream at time t minutes can then be approximated by a second function, $A = 98(1 - 0.95^t)$ mg.

- (a) What is the initial rate at which the drug enters the bloodstream?
- (b) How long will it take before the rate at which the drug enters the bloodstream is halved?
- (c) How long does it takes for
 - i. 10 milligrams of the drug to enter the bloodstream.
 - ii. 50 milligrams of the drug to enter the bloodstream.
 - iii. 95 milligrams of the drug to enter the bloodstream.
- (d) How much of the drug is in the bloodstream when the drug is entering at a rate of 4 mg/min.
- (e) Sketch the graph of R and A , on the same set of axes.
- (f) Will the patient ever feel the full effects of the 100-milligram drug?

- 18.** As consumers, we know from experience that the demand for a product tends to decrease as the price increases. This type of information can be represented by a demand function. The demand function for a particular product is given by $p = 500 - 0.6 \times e^{0.0004x}$, where p is the price per unit and x is the total demand in number of units.

- (a) Find the price p to the nearest dollar for a demand of
 - i. 1000 units.
 - ii. 5000 units.
 - iii. 10 000 units.
- (b) Sketch the graph of this demand function.
- (c) What level of demand will produce a price per unit of \$200?

The total revenue, R , obtained by selling x units of this product is given by $R = xp$.

- (d) Find the revenue by selling
 - i. 1000 units
 - ii. 5000 units
 - iii. 10 000 units
- (e) Sketch the graph of the revenue equation.
- (f) Find the number of units that must be sold in order to maximize the total revenue.
- (g) Determine the maximum revenue. Giving your answer to 2 d.p.

7.3 LOGARITHMS

7.3.1 WHAT ARE LOGARITHMS?

Consider the following sequence of numbers:

Sequence N	1	2	3	4	5	6	7	8	9	10	...
Sequence y	2	4	8	16	32	64	128	256	512	1024	

The relationship between the values of N and y is given by $y = 2^N$.

Using the above table, evaluate the product 16×64 . Using the above table? What for? Clearly there is no use for such a table. Surely this can be done using mental arithmetic (or even using a calculator!). There really is no need to use the above table. However, let's explore this question further, in the hope that we might find something more than the answer.

We start by setting up a table of values that correspond to the numbers in question:

N	4	6	Sum($4 + 6$) = 10
y	16	64	Product = 1024

From the first table of sequences, we notice that the sum of the ' N -sequence' (i.e., 10), corresponds to the value of the ' y -sequence' (i.e., 1024).

We next consider the product 8×32 , again. Setting up a table of values for the numbers in the sequences that are under investigation we have:

N	3	5	Sum($3 + 5$) = 8
y	8	32	Product = 256

What about 4×64 ? As before, we set up the required table of values:

N	2	6	Sum($2 + 6$) = 8
y	4	64	Product = 256

In each case the **product** of two terms of the sequence y corresponds to the **sum** obtained by adding corresponding terms of the sequence N .

Notice then that **dividing** two numbers from the sequence y corresponds to the result when **subtracting** the two corresponding numbers from the sequence N ,

e.g., for the sequence y : $512 \div 32 = 16$.

for the sequence N : $9 - 5 = 4$

This remarkable property was observed as early as 1594 by **John Napier**. John Napier was born in 1550 (when his father was all of sixteen years of age!) He lived most of his life at the family estate of Merchiston Castle, near Edinburgh, Scotland. Although his life was not without controversy, in matters both religious and political, Napier (when relaxing from his political and

MATHEMATICS – Higher Level (Core)

religious polemics) would indulge in the study of mathematics and science. His amusement with the study of mathematics led him to the invention of logarithms. In 1614 Napier published his discussion of logarithms in a brochure entitled *Mirifici logarithmorum canonis descriptio* (A description of the Wonderful Law of Logarithms). Napier died in 1617.

It is only fair to mention that the Swiss instrument maker **Jobst Bürgi** (1552–1632) conceived and constructed a table of logarithms independently of Napier, publishing his results in 1620, six years after Napier had announced his discovery.

One of the anomalies in the history of mathematics is the fact that logarithms were discovered before exponents were in use.

Although in this day and age of technology, the use of electronic calculators and computers, render the evaluation of products and quotients to a task that involves the simple push of a few buttons, logarithms are an efficient means of converting a product to a sum and a quotient to a difference. So, what are logarithms?

Nowadays, a logarithm is universally regarded as an exponent.

Thus, if $y = b^N$ we say that N is the logarithm of y to the base b .

From the sequence table, we have that $2^7 = 128$, so that 7 is the **logarithm** of 128 to the **base 2**. Similarly, $3^4 = 81$, and so 4 is the **logarithm** of 81 to the **base 3**.

We use the following notation when using logarithms: $y = b^N \Leftrightarrow N = \log_{bN} y$

That is, **N is the logarithm of y to the base b** , which corresponds to the power that the base b must be raised so that the result is y .

EXAMPLE 7.12

Find the following logarithms

- (a) $\log_2 32$ (b) $\log_{10} 1000$ (c) $\log_3 729$ (d) $\log_{\frac{1}{2}} 16$

S
o
l
u
t
i
o
n

(a) To determine the number $\log_2 32$, we ask ourselves the following question:

“To what power must we raise the number 2, so that our result is 32?”

Letting $x = \log_2 32$, we must find the number x such that $2^x = 32$.

Clearly then, $x = 5$, and so we have that $\log_2 32 = 5$.

One convention in setting out such questions is: $\log_2 32 = x \Leftrightarrow 2^x = 32$
 $\Leftrightarrow x = 5$

(b) As in part (a), we ask the question

“To what power must we raise the number 10, so that our result is 1000?”

That is, $x = \log_{10} 1000 \Leftrightarrow 10^x = 1000$

$$\Leftrightarrow x = 3$$

So that $\log_{10} 1000 = 3$.

(c) Now, $x = \log_3 729 \Leftrightarrow 3^x = 729$

$$\Leftrightarrow x = 6 \quad \text{[This was obtained by trial and error.]}$$

Therefore, $\log_3 729 = 6$.

(d) Although we have a fraction, this does not alter the process:

$$x = \log_2 \frac{1}{16} \Leftrightarrow 2^x = \frac{1}{16}$$

$$\Leftrightarrow 2^x = \frac{1}{2^4} (= 2^{-4})$$

$$\Leftrightarrow x = -4$$

7.3.2 CAN WE FIND THE LOGARITHM OF A NEGATIVE NUMBER?

To evaluate $\log_a(-4)$ for some base $a > 0$, we need to solve the equivalent statement:

$$x = \log_a(-4) \Leftrightarrow a^x = -4.$$

However, the value of a^x where $a > 0$, will always be positive, therefore there is no value of x for which $a^x = -4$. This means that

we can not evaluate the logarithm of a negative number.

We can now make our definition a little stronger:

$$N = \log_b y \Leftrightarrow y = b^N, y > 0$$

Note: we also require that $b \neq 1$, otherwise we will have that $y = 1^N = 1$ for any value of N .

As we saw earlier, there exists a natural exponential whose base is ‘ e ’. In the same way we also have the natural logarithm, whose base is also ‘ e ’.

In this instance, we refer to this **logarithm base ‘ e ’** as the **natural logarithm**.

We denote the natural logarithm by $\log_e x$ or $\ln x$ (read as ‘ $el n$ ’). i.e., $y = e^N \Leftrightarrow N = \log_e y$.

For example, $\log_e e^2 = 2$. That is, $N = \log_e e^2 \Leftrightarrow e^N = e^2$

$$\Leftrightarrow N = 2$$

EXAMPLE 7.13

Find the value of x given that

(a) $\log_e x = 3$ (b) $\log_e(x-2) = 0.5$ (c) $\log_e 5 = x$

S
o
i
l
u
t
i
o
n

(a) $\log_e x = 3 \Leftrightarrow x = e^3 \approx 20.09$

(b) $\log_e(x-2) = 0.5 \Leftrightarrow x-2 = e^{0.5}$

$$\Leftrightarrow x = 2 + \sqrt{e}$$

$$\therefore x \approx 3.65$$

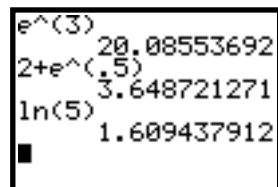

(c) $x = \log_e 5 \approx 1.61$

Notice that your calculator has two logarithmic functions:

The **log** button stands for $\log_{10} x$.

The **ln** button stands for $\log_e x$.

EXERCISES 7.3

1. Use the definition of a logarithm to determine

- (a) $\log_6 36$ (b) $\log_7 49$ (c) $\log_3 243$ (d) $\log_4 64$
 (e) $\log_2 \left(\frac{1}{8}\right)$ (f) $\log_3 \left(\frac{1}{9}\right)$ (g) $\log_4 1$ (h) $\log_{10} 1$
 (i) $\log_{\frac{1}{2}} 2$ (j) $\log_{\frac{1}{3}} 9$ (k) $\log_3 \sqrt{3}$ (l) $\log_{10} 0.01$

2. Change the following exponential expressions into their equivalent logarithmic form.

- (a) $10^4 = 10000$ (b) $10^{-3} = 0.001$ (c) $10^y = x + 1$
 (d) $10^7 = p$ (e) $2^y = x - 1$ (f) $2^{4x} = y - 2$

3. Change the following logarithmic expressions into their equivalent exponential form.

- (a) $\log_2 x = 9$ (b) $\log_b y = x$ (c) $\log_b t = ax$
 (d) $\log_{10} z = x^2$ (e) $\log_{10} y = 1 - x$ (f) $\log_2(ax - b) = y$

4. Solve for x in each of the following.

- (a) $\log_2 x = 4$ (b) $\log_3 9 = x$ (c) $\log_4 x = \frac{1}{2}$
 (d) $\log_x 3 = \frac{1}{2}$ (e) $\log_x 2 = 4$ (f) $\log_5 x = 3$
 (g) $\log_x 16 = 2$ (h) $\log_x 81 = 2$ (i) $\log_x \left(\frac{1}{3}\right) = 3$
 (j) $\log_2(x - 5) = 4$ (k) $\log_3 81 = x + 1$ (l) $\log_3(x - 4) = 2$

5. Solve for x in each of the following, giving your answer to 4 d.p.

- (a) $\log_e x = 4$ (b) $\log_e 4 = x$ (c) $\log_e x = \frac{1}{2}$
 (d) $\log_x e = \frac{1}{2}$ (e) $\log_x e = 2$ (f) $\log_x e = -1$
 (g) $\log_e(x + 2) = 4$ (h) $\log_e(x - 2) = 1$ (i) $\log_x e = -2$

7.4 THE ALGEBRA OF LOGARITHMS

The following logarithmic laws are a direct consequence of the definition of a logarithm and the index laws already established.

First law: The logarithm of a product

$$\log_a(x \times y) = \log_a x + \log_a y, x > 0, y > 0$$

Proof: Let $M = \log_a x$ and $N = \log_a y$ so that $x = a^M$ and $y = a^N$.

$$\text{Then, } x \times y = a^M \times a^N$$

$$\Leftrightarrow x \times y = a^{M+N}$$

$$\Leftrightarrow \log_a(x \times y) = M + N$$

$$\Leftrightarrow \log_a(x \times y) = \log_a x + \log_a y$$

EXAMPLE 7.14

Simplify the expression

(a) $\log_3 x + \log_3(4x)$ (b) $\log_2 x + \log_2(4x)$

S
o
l
u
t
i
o
n

(a) $\log_3 x + \log_3(4x) = \log_3(x \times 4x)$
 $= \log_3 4x^2$

(b) This time we note that because the base is '2' and there is a '4' in one of the logarithmic expressions, we could first try to 'remove the '4'.

$$\begin{aligned} \log_2 x + \log_2(4x) &= \log_2 x + (\log_2 4 + \log_2 x) \\ &= \log_2 x + 2 + \log_2 x \\ &= 2\log_2 x + 2 \end{aligned}$$

EXAMPLE 7.15

Given that $\log_a p = 0.70$ and $\log_a q = 2$, evaluate the following

(a) $\log_a p^2$ (b) $\log_a(p^2 q)$ (c) $\log_a(apq)$

S
o
l
u
t
i
o
n

(a) $\log_a p^2 = \log_a(p \times p) = \log_a p + \log_a p$
 $= 2\log_a p$
 $= 2 \times 0.70$
 $= 1.40$

(b) $\log_a(p^2 q) = \log_a p^2 + \log_a q$
 $= 2\log_a p + \log_a q$
 $= 1.40 + 2$
 $= 3.40$

$$\begin{aligned} \text{(c)} \quad \log_a(apq) &= \log_a a + \log_a p + \log_a q \\ &= 1 + 0.70 + 2 \\ &= 3.70 \end{aligned}$$

EXAMPLE 7.16

Find $\{x \mid \log_2 x + \log_2(x+2) = 3\}$.

S
o
l
u
t
i
o
n

$$\begin{aligned} \log_2 x + \log_2(x+2) = 3 &\Leftrightarrow \log_2[x \times (x+2)] = 3 \\ &\Leftrightarrow x(x+2) = 2^3 \\ &\Leftrightarrow x^2 + 2x = 8 \\ &\Leftrightarrow x^2 + 2x - 8 = 0 \\ &\Leftrightarrow (x+4)(x-2) = 0 \\ &\Leftrightarrow x = -4 \text{ or } x = 2 \end{aligned}$$

Next, we must check our solutions.

When $x = -4$, substituting into the **original equation**, we have:

L.H.S = $\log_2(-4) + \log_2(-4+2)$ – which cannot be evaluated (as the logarithm of a negative number does not exist).

Therefore, $x = -4$, is not a possible solution.

When $x = 2$, substituting into the **original equation**, we have:

$$\begin{aligned} \text{L.H.S} &= \log_2(2) + \log_2(2+2) \\ &= \log_2 8 \\ &= 3 \\ &= \text{R.H.S} \end{aligned}$$

Therefore, $\{x \mid \log_2 x + \log_2(x+2) = 3\} = \{2\}$.

Second law: The logarithm of a quotient

$$\log_a\left(\frac{x}{y}\right) = \log_a x - \log_a y, \quad x > 0, y > 0$$

Proof: Let $M = \log_a x$ and $N = \log_a y$ so that $x = a^M$ and $y = a^N$.

$$\begin{aligned} \text{Then, } \frac{x}{y} &= \frac{a^M}{a^N} \\ &\Leftrightarrow \frac{x}{y} = a^{M-N} \\ &\Leftrightarrow \log_a\left(\frac{x}{y}\right) = M - N \\ &\Leftrightarrow \log_a\left(\frac{x}{y}\right) = \log_a x - \log_a y \end{aligned}$$

EXAMPLE 7.17

Simplify

(a) $\log_{10}100x - \log_{10}xy$ (b) $\log_2 8x^3 - \log_2 x^2 + \log_2\left(\frac{y}{x}\right)$

**S
o
l
u
t
i
o
n**

(a)
$$\begin{aligned}\log_{10}100x - \log_{10}xy &= \log_{10}\left(\frac{100x}{xy}\right) \\ &= \log_{10}\left(\frac{100}{y}\right)\end{aligned}$$

 Note: We could then express $\log_{10}\left(\frac{100}{y}\right)$ as $\log_{10}100 - \log_{10}y = 2 - \log_{10}y$.

(b)
$$\begin{aligned}\log_2 8x^3 - \log_2 x^2 + \log_2\left(\frac{y}{x}\right) &= \log_2\left(\frac{8x^3}{x^2}\right) + \log_2\left(\frac{y}{x}\right) \\ &= \log_2 8x + \log_2\left(\frac{y}{x}\right) \\ &= \log_2\left(8x \times \frac{y}{x}\right) \\ &= \log_2 8y\end{aligned}$$

 Note: We could then express $\log_2 8y$ as $\log_2 8 + \log_2 y = 3 + \log_2 y$.

EXAMPLE 7.18

 Find $\{x \mid \log_{10}(x+2) - \log_{10}(x-1) = 1\}$
**S
o
l
u
t
i
o
n**

$$\begin{aligned}\log_{10}(x+2) - \log_{10}(x-1) = 1 &\Leftrightarrow \log_{10}\left(\frac{x+2}{x-1}\right) = 1 \\ &\Leftrightarrow \left(\frac{x+2}{x-1}\right) = 10^1 \\ &\Leftrightarrow x+2 = 10x-10 \\ &\Leftrightarrow 12 = 9x \\ &\Leftrightarrow x = \frac{4}{3}\end{aligned}$$

Next, we check our answer. Substituting into the original equation, we have:

$$\begin{aligned}\text{L.H.S} &= \log_{10}\left(\frac{4}{3} + 2\right) - \log_{10}\left(\frac{4}{3} - 1\right) = \log_{10}\frac{10}{3} - \log_{10}\frac{1}{3} = \log_{10}\left(\frac{10}{3} \div \frac{1}{3}\right) \\ &= \log_{10}10 \\ &= 1 = \text{R.H.S}\end{aligned}$$

 Therefore, $\{x \mid \log_{10}(x+2) - \log_{10}(x-1) = 1\} = \left\{\frac{4}{3}\right\}$

Third law: The logarithm of a power

$$\log_a x^n = n \log_a x, x > 0$$

Proof: This follows from repeated use of the First Law or it can be shown as follows:

$$\text{Let } M = \log_a x \Leftrightarrow a^M = x$$

$$\Leftrightarrow (a^M)^n = x^n \quad [\text{Raising both sides to the power of } n]$$

$$\Leftrightarrow a^{nM} = x^n \quad [\text{Using the index laws}]$$

$$\Leftrightarrow nM = \log_a x^n \quad [\text{Converting from exponential to log form}]$$

$$\Leftrightarrow n \log_a x = \log_a x^n$$

EXAMPLE 7.19

Given that $\log_a x = 0.2$ and $\log_a y = 0.5$, evaluate

(a) $\log_a x^3 y^2$ (b) $\log_a \sqrt{\frac{x}{y^4}}$

**S
o
l
u
t
i
o
n**

$$\begin{aligned} \text{(a)} \quad \log_a x^3 y^2 &= \log_a x^3 + \log_a y^2 \\ &= 3 \log_a x + 2 \log_a y \\ &= 3 \times 0.2 + 2 \times 0.5 \\ &= 1.6 \end{aligned}$$

$$\begin{aligned} \text{(b)} \quad \log_a \sqrt{\frac{x}{y^4}} &= \log_a \left(\frac{x}{y^4} \right)^{1/2} = \frac{1}{2} \log_a \left(\frac{x}{y^4} \right) \\ &= \frac{1}{2} [\log_a(x) - \log_a y^4] \\ &= \frac{1}{2} [\log_a x - 4 \log_a y] \\ &= \frac{1}{2} [0.2 - 4 \times 0.5] \\ &= -0.9 \end{aligned}$$

Fourth law: Change of base

$$\log_a b = \frac{\log_k b}{\log_k a}, a, k \in \mathbb{R}^+ \setminus \{1\}$$

Proof: Let $\log_a b = N$ so that $a^N = b$

Taking the logarithms to base k of both sides of the equation we have:

$$\log_k(a^N) = \log_k b \Leftrightarrow N \log_k a = \log_k b$$

$$\Leftrightarrow N = \frac{\log_k b}{\log_k a}$$

However, we have that $\log_a b = N$, therefore, $\log_a b = \frac{\log_k b}{\log_k a}$.

Other observations include:

1. $\log_a a = 1$
2. $\log_a 1 = 0$
3. $\log_a x^{-1} = -\log_a x, x > 0$
4. $\log_{\frac{1}{a}} x = -\log_a x$
5. $a^{\log_a x} = x, x > 0$

MISCELLANEOUS EXAMPLES

EXAMPLE 7.20

Express y in terms of x if (a) $2 + \log_{10} x = 4 \log_{10} y$
 (b) $\log x = \log(a - by) - \log a$

S
o
l
u
t
i
o
n

(a) Given that $2 + \log_{10} x = 4 \log_{10} y$ then $2 = 4 \log_{10} y - \log_{10} x$

$$\Leftrightarrow 2 = \log_{10} y^4 - \log_{10} x$$

$$\Leftrightarrow 2 = \log_{10} \left(\frac{y^4}{x} \right)$$

$$\Leftrightarrow 10^2 = \frac{y^4}{x}$$

$$\Leftrightarrow y^4 = 100x$$

$$\Leftrightarrow y = \sqrt[4]{100x} \quad (\text{as } y > 0)$$

(b) Given that $\log x = \log(a - by) - \log a$ then $\log x = \log \frac{a - by}{a}$

$$\Leftrightarrow x = \frac{a - by}{a}$$

$$\Leftrightarrow ax = a - by$$

$$\Leftrightarrow by = a - ax$$

$$\Leftrightarrow y = \frac{a}{b}(1 - x)$$

EXAMPLE 7.21

Find x if (a) $\log_x 64 = 3$ (b) $\log_{10} x - \log_{10}(x - 2) = 1$

S
o
l
u
t
i
o
n

(a) $\log_x 64 = 3 \Leftrightarrow x^3 = 64$

$$\Leftrightarrow x^3 = 4^3$$

$$\Leftrightarrow x = 4$$

(b) $\log_{10} x - \log_{10}(x - 2) = 1 \Leftrightarrow \log_{10} \left(\frac{x}{x - 2} \right) = 1$

$$\begin{aligned} \Leftrightarrow \frac{x}{x-2} &= 10^1 \\ \Leftrightarrow x &= 10x - 20 \\ \Leftrightarrow -9x &= -20 \\ \Leftrightarrow x &= \frac{20}{9} \end{aligned}$$

We still need to check our answer: substituting $x = \frac{20}{9}$ into the original equation we have:

$$\begin{aligned} \text{L.H.S} &= \log_{10} \frac{20}{9} - \log_{10} \left(\frac{20}{9} - 2 \right) = \log_{10} \frac{20}{9} - \log_{10} \left(\frac{2}{9} \right) = \log_{10} \left(\frac{20}{9} \times \frac{9}{2} \right) \\ &= \log_{10} 10 \\ &= 1 \\ &= \text{R.H.S} \end{aligned}$$

Therefore, solution is $x = \frac{20}{9}$.

EXAMPLE 7.22

Find $\{x \mid 5^x = 2^{x+1}\}$. Give both an exact answer and one to 2 d.p.

S
o
l
u
t
i
o
n

Taking the logarithm of base 10 of both sides $5^x = 2^{x+1}$ gives:

$$\begin{aligned} 5^x = 2^{x+1} &\Leftrightarrow \log_{10} 5^x = \log_{10} 2^{x+1} \\ \Leftrightarrow x \log_{10} 5 &= (x+1) \log_{10} 2 \\ \Leftrightarrow x \log_{10} 5 - x \log_{10} 2 &= \log_{10} 2 \\ \Leftrightarrow x(\log_{10} 5 - \log_{10} 2) &= \log_{10} 2 \\ \Leftrightarrow x &= \frac{\log_{10} 2}{\log_{10} 5 - \log_{10} 2} \end{aligned}$$

And so, $x = 0.75647\dots = 0.76$ (to 2 d.p).

$$\text{Exact answer} = \left\{ \frac{\log_{10} 2}{\log_{10} 5 - \log_{10} 2} \right\}, \text{ answer to 2 d.p} = \{0.76\}$$

EXAMPLE 7.23

Find x , where $6e^{2x} - 17 \times e^x + 12 = 0$

S
o
l
u
t
i
o
n

We first note that $6e^{2x} - 17 \times e^x + 12$ can be written as $6 \times e^{2x} - 17 \times e^x + 12$.

Which in turn can be expressed as $6 \times (e^x)^2 - 17 \times e^x + 12$.

Therefore, making the substitution $y = e^x$, we have that

$$6 \times (e^x)^2 - 17 \times e^x + 12 = 6y^2 - 17y + 12 \text{ (i.e., we have a 'hidden' quadratic)}$$

Solving for y , we have:

$$6y^2 - 17y + 12 = 0 \Leftrightarrow (2y - 3)(3y - 4) = 0$$

So that

$$y = \frac{3}{2} \text{ or } y = \frac{4}{3}$$

However, we wish to solve for x , and so, we need to substitute back:

$$\begin{aligned} e^x &= \frac{3}{2} \text{ or } e^x = \frac{4}{3} \\ \Leftrightarrow x &= \ln \frac{3}{2} \text{ or } x = \ln \frac{4}{3} \end{aligned}$$

EXAMPLE 7.24

Solve for x , where $8^{2x+1} = 4^{5-x}$

S
o
l
u
t
i
o
n

Taking logs of both sides of the equation $8^{2x+1} = 4^{5-x}$, we have

$$\begin{aligned} \log 8^{2x+1} &= \log 4^{5-x} \Leftrightarrow (2x+1)\log 8 = (5-x)\log 4 \\ &\Leftrightarrow (2x+1)\log 2^3 = (5-x)\log 2^2 \\ &\Leftrightarrow 3(2x+1)\log 2 = 2(5-x)\log 2 \end{aligned}$$

Therefore, we have that $6x + 3 = 10 - 2x \Leftrightarrow 8x = 7$

$$\therefore x = \frac{7}{8}$$

EXERCISES 7.4

- Without using a calculator, evaluate the following.

(a) $\log_2 8 + \log_2 4$	(b) $\log_6 18 + \log_6 2$	(c) $\log_5 2 + \log_5 12.5$
(d) $\log_3 18 - \log_3 6$	(e) $\log_2 20 - \log_2 5$	(f) $\log_2 10 - \log_2 5$

- Write down an expression for $\log a$ in terms of $\log b$ and $\log c$ for the following.

(a) $a = bc$	(b) $a = b^2c$	(c) $a = \frac{1}{c^2}$
(d) $a = b\sqrt{c}$	(e) $a = b^3c^4$	(f) $a = \frac{b^2}{\sqrt{c}}$

- Given that $\log_a x = 0.09$, find

(a) $\log_a x^2$	(b) $\log_a \sqrt{x}$	(c) $\log_a \left(\frac{1}{x}\right)$
------------------	-----------------------	---------------------------------------

MATHEMATICS – Higher Level (Core)

4. Express each of the following as an equation that does not involve a logarithm.

- (a) $\log_2 x = \log_2 y + \log_2 z$ (b) $\log_{10} y = 2\log_{10} x$
(c) $\log_2(x+1) = \log_2 y + \log_2 x$ (d) $\log_2 x = y + 1$
(e) $\log_2 y = \frac{1}{2}\log_2 x$ (f) $3\log_2(x+1) = 2\log_2 y$

5. Solve the following equations

- (a) $\log_2(x+1) - \log_2 x = \log_2 3$
(b) $\log_{10}(x+1) - \log_{10} x = \log_{10} 3$
(c) $\log_2(x+1) - \log_2(x-1) = 4$
(d) $\log_{10}(x+3) - \log_{10} x = \log_{10} x + \log_{10} 2$
(e) $\log_{10}(x^2+1) - 2\log_{10} x = 1$
(f) $\log_2(3x^2+28) - \log_2(3x-2) = 1$
(g) $\log_{10}(x^2+1) = 1 + \log_{10}(x-2)$
(h) $\log_2(x+3) = 1 - \log_2(x-2)$
(i) $\log_6(x+5) + \log_6 x = 2$
(j) $\log_3(x-2) + \log_3(x-4) = 2$
(k) $\log_2 x - \log_2(x-1) = 3\log_2 4$
(l) $\log_{10}(x+2) - \log_{10} x = 2\log_{10} 4$

6. Simplify the following

- (a) $\log_3(2x) + \log_3 w$ (b) $\log_4 x - \log_4(7y)$
(c) $2\log_a x + 3\log_a(x+1)$ (d) $5\log_a x - \frac{1}{2}\log_a(2x-3) + 3\log_a(x+1)$
(e) $\log_{10} x^3 + \frac{1}{3}\log x^3 y^6 - 5\log_{10} x$ (f) $2\log_2 x - 4\log_2\left(\frac{1}{y}\right) - 3\log_2 xy$

7. Solve the following

- (a) $\log_2(x+7) + \log_2 x = 3$ (b) $\log_3(x+3) + \log_3(x+5) = 1$
(c) $\log_{10}(x+7) + \log_{10}(x-2) = 1$ (d) $\log_3 x + \log_3(x-8) = 2$
(e) $\log_2 x + \log_2 x^3 = 4$ (f) $\log_3 \sqrt{x} + 3\log_3 x = 7$

8. Solve for x .

- (a) $\log_2 x^2 = (\log_2 x)^2$ (b) $\log_3 x^3 = (\log_3 x)^3$
(c) $\log_4 x^4 = (\log_4 x)^4$ (d) $\log_5 x^5 = (\log_5 x)^5$

Investigate the solution to $\log_n x^n = (\log_n x)^n$

9. Solve the following, giving an exact answer and an answer to 2 d.p.

(a) $2^x = 14$	(b) $10^x = 8$	(c) $3^x = 125$
(d) $\frac{1}{1-2^x} = 12$	(e) $3^{4x+1} = 10$	(f) $0.8^{x-1} = 0.4$
(g) $10^{-2x} = 2$	(h) $2.7^{0.3x} = 9$	(i) $0.2^{-2x} = 20$
(j) $\frac{2}{1+0.4^x} = 5$	(k) $\frac{2^x}{1-2^x} = 3$	(l) $\frac{3^x}{3^x+3} = \frac{1}{3}$

10. Solve for x

(a) $(\log_2 x)^2 - \log_2 x - 2 = 0$	(b) $\log_2(2^{x+1} - 8) = x$
(c) $\log_{10}(x^2 - 3x + 6) = 1$	(d) $(\log_{10} x)^2 - 11 \log_{10} x + 10 = 0$
(e) $\log_x(3x^2 + 10x) = 3$	(f) $\log_{x+2}(3x^2 + 4x - 14) = 2$

11. Solve the following simultaneous equations

(a) $x^y = 5x - 9$	(b) $\log_{10} x - \log_{10} y = 1$	(c) $xy = 2$
$\log_x 11 = y$	$x + y^2 = 200$	$2 \log_2 x - \log_2 y = 2$

12. Express each of the following as an equation that does not involve a logarithm.

(a) $\log_e x = \log_e y - \log_e z$	(b) $3 \log_e x = \log_e y$	(c) $\ln x = y - 1$
--------------------------------------	-----------------------------	---------------------

13. Solve the following for x

(a) $\ln(x+1) - \ln x = 4$	(b) $\ln(x+1) - \ln x = \ln 4$
(c) $\log_e(x+1) + \log_e x = 0$	(d) $\log_e(x+1) - \log_e x = 0$

14. Solve the following for x

(a) $e^x = 21$	(b) $e^x - 2 = 8$	(c) $-5 + e^{-x} = 2$
(d) $200e^{-2x} = 50$	(e) $\frac{2}{1-e^{-x}} = 3$	(f) $70e^{-\frac{1}{2}x} + 15 = 60$
(g) $\ln x = 3$	(h) $2 \ln(3x) = 4$	(i) $\ln(x^2) = 9$
(j) $\ln x - \ln(x+2) = 3$	(k) $\ln \sqrt{x+4} = 1$	(l) $\ln(x^3) = 9$

15. Solve the following for x

(a) $e^{2x} - 3e^x + 2 = 0$	(b) $e^{2x} - 4e^x - 5 = 0$
(c) $e^{2x} - 5e^x + 6 = 0$	(d) $e^{2x} - 2e^x + 1 = 0$
(e) $e^{2x} - 6e^x + 5 = 0$	(f) $e^{2x} - 9e^x - 10 = 0$

16. Solve each of the following

(a) $4^{x-1} = 132$

(b) $5^{5x-1} = 3^{1-2x}$

(c) $3^{2x+1} - 7 \times 3^x + 4 = 0$

(d) $2^{2x+3} - 7 \times 2^{x+1} + 5 = 0$

(e) $3 \times 4^{2x+1} - 2 \times 4^{x+2} + 5 = 0$

(f) $3^{2x} - 3^{x+2} + 8 = 0$

(g) $2\log x + \log 4 = \log(9x - 2)$

(h) $2\log 2x - \log 4 = \log(2x - 1)$

(i) $\log_3 2x + \log_3 81 = 9$

(j) $\log_2 x + \log_x 2 = 2$

7.5 LOGARITHMIC MODELLING

Some examples of where the logarithmic functions are used can be found in:

i. the measurement of the magnitude of an earthquake (better known as the Richter scale), where the magnitude R of an earthquake of intensity I is given by $R = \log_{10} \left(\frac{I}{I_0} \right)$, where I_0 is a certain minimum intensity.

ii. the measurement of children's weight (better known as The Ehrenberg relation) is given by $\log_{10} W = \log_{10} 2.4 + 0.8h$, where W kg is the average weight for children aged 5 through to 13 years and h is the height measured in metres.

iii. the brightness of stars, given by the function $m = 6 - 2.5 \log_{10} \left(\frac{L}{L_0} \right)$, where L_0 is the light flux of the faintest star visible to the naked eye (having magnitude 6), and m is the magnitude of brighter stars having a light flux L .

EXAMPLE 7.25

After working through an area of study, students in year 7 sat for a test based on this unit. Over the following two years, the same students were retested on several occasions. The average score was found to be modelled by the function

$$S = 90 - 20 \log_{10}(t + 1), \quad 0 \leq t \leq 24 \quad \text{where } t \text{ is measured in months.}$$

- (a) What was the average score on the first test?
 (b) What was the score after i. 6 months? ii. 2 years?
 (c) How long should it be before the test is re-issued, if the average score is to be 80?

S
o
l
u
t
i
o
n

(a) The first test occurs at time $t = 0$, so that

$$S = 90 - 20 \log_{10}(0 + 1) = 90 - 20 \log 1 = 90$$

That is, the average score on the first test was 90%.

(b) i. After six months we have that $t = 6$. Therefore, $S = 90 - 20 \log_{10}(6 + 1) \approx 73$.
 That is, the average score on the test after six months was 73%.

ii. After 2 years we have that $t = 24$. Therefore, $S = 90 - 20 \log_{10}(24 + 1) \approx 62$.
 That is, the average score on the test after two years was 62%.

- (c) We need to find t when $S = 80$. Using the given equation we have:

$$80 = 90 - 20\log_{10}(t + 1) \Leftrightarrow 20\log_{10}(t + 1) = 10$$

$$\Leftrightarrow \log_{10}(t + 1) = \frac{1}{2}$$

$$\Leftrightarrow t + 1 = \sqrt{10}$$

$$\Leftrightarrow t = \sqrt{10} - 1$$

That is, $t \approx 2.16$

Therefore, the students should be retested in approximately 2 months time.

EXERCISES 7.5

1. The loudness of a sound, as experienced by the human ear, is based on its intensity level.

This intensity level is modelled by the logarithmic function $d = 10\log_{10}\left(\frac{I}{I_0}\right)$

where d is measured in decibels and corresponds to a sound intensity I and I_0 (known as the threshold intensity) is the value of I that corresponds to be the weakest sound that can be detected by the ear under certain conditions.

- Find the value of d when I is 10 times as great as I_0 (i.e., $I = 10I_0$).
 - Find the value of d when I is 1000 times as great as I_0 .
 - Find the value of d when I is 10000 times as great as I_0 .
2. A model, for the relationship between the average weight W kilograms and the height h metres for children aged 5 through to 13 years has been closely approximated by the function $\log_{10}W = \log_{10}2.4 + 0.80h$
- Based on this model, determine the average weight of a 10-year-old child who is 1.4 metres tall.
 - How tall would an 8 year old child weighing 50 kg be?
 - Find an expression for the weight, W , as a function of h .
 - Sketch the graph of W kg versus h m.
 - Hence, or otherwise, sketch the graph of h m versus W kg.
3. A measure of the ‘energy’ of a star can be related to its brightness. To determine this ‘energy’ stars are classified into categories of brightness called magnitudes. Those considered to be the least ‘energetic’ are labelled as the faintest stars. Such stars have a light flux given by L_0 , and are assigned a magnitude 6. Other brighter stars having a light flux L are assigned a magnitude m by means of the formula $m = 6 - 2.5\log_{10}\left(\frac{L}{L_0}\right)$.
- Find the magnitude m of a star, if relative to the faintest star, its light flux L is such that $L = 10^{0.5}L_0$.
 - Find an equation for L in terms of m and L_0 .
 - Sketch the general shape of the function for L (as a function of m).

(d) Hence, or otherwise, sketch the graph of the function $m = 6 - 2.5 \log_{10} \left(\frac{L}{L_0} \right)$.

4. For some manufacturers, it is important to consider the failure time of their computer chips. For Multi-Chips Pty Ltd, the time taken before a fraction x of their computer chips

fail has been approximated by the logarithmic function $t = -\frac{1}{c} \log_{10}(1-x)$, where c is some positive constant and time t is measured in years.

- Define the domain for this function.
- Determine how long will it be before 40% of the chips fail, when
 - $c = 0.1$
 - $c = 0.2$
 - $c = 0.3$
- How does the value of c affect the reliability of a chip?
- Find an expression for the fraction x of chips that will fail after t years.
- For the case where $c = 0.10$, sketch the graph of x versus t . Hence, sketch the graph

of $t = -\frac{1}{c} \log_{10}(1-x)$ where $c = 0.10$.

5. Logarithms have been found useful in modelling economic situations in some countries. Pareto's law for capitalist countries states that the relationship between annual income, \$ I and the number, n , of individuals whose income exceeds \$ I is approximately modelled by the function $\log_{10} I = \log_{10} a - k \log_{10} n$ where a and k are real positive constants.

- Find an expression for I that does not involve logarithms.
- By varying the values of a and b , describe their effects on
 - the income \$ I .
 - the number of people whose income exceeds \$ I .

6. After prolonged observations of our environment, it became obvious that the thickness of the ozone layer had been affected by the production of waste that had taken place over many years. The thickness of the ozone layer has been estimated by making use of the function $\log_{10} \lambda_0 - \log_{10} \lambda = kx$, where λ_0 is the intensity of a particular wavelength of light from the sun before it reaches the atmosphere, λ is the intensity of the same wavelength after passing through a layer of ozone x centimetres thick, and k is the absorption constant of ozone for that wavelength.

The following table has some results based on available data for one region of the Earth's atmosphere:

λ_0	k	$\frac{\lambda_0}{\lambda}$
3200×10^{-8}	$k \approx 0.40$	1.10

- Based on the above table, find the approximate thickness of the ozone layer in this region of the atmosphere, giving your answer to the nearest hundredth of a centimetre.
- Obtain an expression for the intensity λ , in terms of k , λ_0 and x .
- What would the percentage decrease in the intensity of light with a wavelength of 3200×10^{-8} cm be, if the ozone layer is 0.20 centimetre thick?
- For a fixed value of λ_0 , how does k relate to the intensity λ ?

REVISION SET A - PAPER 1 & PAPER 2 STYLE QUESTIONS

1. Find the coefficient of x^2 in the expansion of $(2x - 1)^7$.
2. A function f is defined by $f: \mathbb{R} \mapsto \mathbb{R}$, where $f(x) = e^x - 1$.
 - (a) Sketch the graph of f .
 - (b) Find
 - i. the domain of the inverse function, f^{-1} .
 - ii. the rule of the inverse function, f^{-1} .
 - (c) Sketch the graph of f^{-1} on the set of axes used in (a).
3. Find the coefficient of x^6 in the expansion of $\left(2x - \frac{1}{2}\right)^{10}$.
4. Let $f(x) = \sqrt{x}$ and $g(x) = 4 - x^2$.
 - (a) Find
 - i. $f(g(2))$
 - ii. $g(f(2))$
 - (b) State all values of x for which $f(g(x))$ is defined.
 - (c) State all values of x for which $g(f(x))$ is defined.
5.
 - (a) Sketch the graph of $y = 4(x^2 - x^4)$, locating the stationary points and giving their y -coordinates.
 - (b) Sketch on the same set of axes the graph of $y = \frac{1}{4(x^2 - x^4)}$.
6. Let $f(x) = 1 - \frac{3}{x}$, $x \neq 0$ and $g(x) = x^2 - 3x$.
 - (a) Find the coordinates of the points of intersection of the graphs f and g .
 - (b) Sketch on the same set of axes the graphs of f and g .
7.
 - (a) Let $g(x) = e^x$ and $h(x) = \sqrt{x}$. Find $h(g(\log_e 4))$.
 - (b) Consider the function f , where $f(x) = g(h(x))$ and the domain \mathbf{S} of f is the largest set of real numbers for which $f(x)$ is defined. Specify \mathbf{S} , and the range of f .
 - (c) Define completely the inverse function f^{-1} , given that it exists.
8. For the graph shown, sketch, on different sets of axes, the graphs of

- (a) $y = 2 + f(x)$
- (b) $y = f(2x)$
- (c) $y = f(x - 1)$
- (d) $y = f(|x|)$
- (e) $y = f^{-1}(x)$
- (f) $y = |f(x)|$

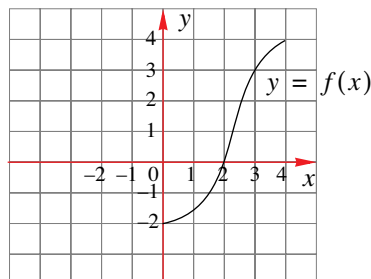

MATHEMATICS – Higher Level (Core)

- 9.** Given that $f(x) = x^3$
- Find $f(8)$
 - $\{x: f(x) = 8\}$
 - Find $f(x+h) - f(x)$.
 - Simplify $\frac{f(x+h) - f(x)}{h}, h \neq 0$.
- 10.** (a) Solve for x , where
 - $(x-1)(x-4) = 10$
 - $\log_e(x+3) - \log_e x = 1$
- (b) Consider the function f defined by, $f: \mathbb{R} \setminus \{2\} \mapsto \mathbb{R}$, where $f(x) = 3 + \frac{1}{x-2}$
- Find
 - the range of f .
 - $\frac{1}{f(2.5)}$
 - $f^{-1}(2.5)$
- 11.** (a) Solve for x , where
 - $(x-3)(x-4) = x$
 - $\log_e(4+3x) = 2$
- (b) Consider the function $f(x) = \log_e x - \log_e(1-x)$
- Find
 - the values of x for which f is defined.
 - the range of f .
 - $(f(0.8))^{-1}$ (to 2 d.p.)
 - $f^{-1}(0.8)$ (to 2 d.p.)
- 12.** (a) Given that $f(x) = \frac{1-x}{1+x}$, find $g(f(x))$ where $g(x) = 1 - \frac{1}{x}$, and specify all values of x for which $g(f(x))$ is defined.
- (b) The curves with equations $y = \sqrt{8x}$ and $y = x^2$ meet at O and P, where O is the origin. Find the coordinates of P.
- 13.** (a) Solve each of the following equations for x , giving exact values in terms of the natural logarithm, 'ln' or in terms of 'e'.
- $3^x = 6$
 - $\log_e(3x+1) - \log_e(4-x) = \log_e 4$
- (b) If $f(x) = x + \frac{1}{x+1}, x > 0$, find $f^{-1}(3)$.
- (c)
 - If $f(x) = \sqrt{x-1}$ and $g(x) = \frac{1}{x^2}$, write down expressions for $f(g(x))$ and $g(f(x))$.
 - For what values of x is $f(g(x))$ defined?
- 14.** Find the value of c for which the coefficient of x^4 in the expansion of $(2x+c)^7$ is 70.

- 15.** (a) Find the solutions to the equation $x^3 - 3x^2 - 9x + 11 = 0$, giving exact values.
 (b) Sketch the graph of the function $f(x) = x^3 - 3x^2 - 9x + 11$, clearly labelling and giving the coordinates of the turning points on the curve.
 (c) If $S = \{x : f(x) + k = 0\}$, find k such that
 i. $n(S) = 1$ ii. $n(S) = 2$ iii. $n(S) = 3$

- 16.** The graph of $y = f(x)$ is shown in the diagram.
 Using different sets of axes for each graph, sketch the graphs of each of the following, showing clearly any intercepts with the axes and any asymptotes:

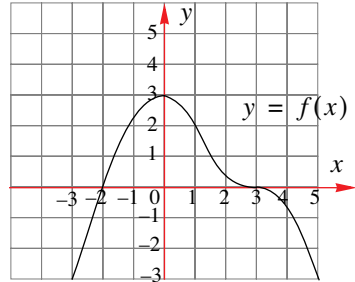

- (a) $y = \frac{2}{3}f(x)$
 (b) $y = f(-x)$
 (c) $y = f(x) + 1$
 (d) $y = \frac{1}{f(x)}$
- 17.** (a) Find k such that the equation $2x^2 + kx + 2k = 0$ has exactly one solution.
 (b) Factorise $6x^3 + 19x^2 + x - 6$.
 (c) Solve $|2x - 3| < 3$

- 18.** (a) For what value of x is $\frac{2}{(x-1)} > \frac{1}{2}$?
 (b) Find the term independent of a in the expansion $\left(a - \frac{1}{a}\right)^8$.
 (c) Solve $2x^4 + x^3 - 6x^2 + x + 2 = 0$

- 19.** (a) i. Factorise the polynomial $P(x) = 2x^3 + x^2 - 13x + 6$.
 ii. Find $\{x | P(x) > 0\}$.
 (b) Find the value of a if the equations $2x + 3y = 6$ and $6x + ay = 9$ are
 i. parallel.
 ii. perpendicular.

- 20.** (a) The coefficient of x in the expansion of $\left(x + \frac{1}{ax^2}\right)^7$ is $\frac{7}{3}$. Find the value(s) of a .
 (b) Divide $4x^4 - 6x^3 + 3x - 5$ by $(2x - 1)$.
 (c) For what value of x is $\frac{x^2 - 4}{x} > 0$?

- 21.** (a) Solve for x , the inequality $|2x - 3| < |x + 2|$.
 (b) Find the equation of the line which passes through both the intersection of $x + y = 2$ and $2x + 3y = 8$ and the point $(0, 0)$.
 (c) Simplify $\frac{x^3 - y^3}{x^3 + y^3} \times \frac{(x - y)^2 + xy}{x^2 + xy + y^2}$.

MATHEMATICS – Higher Level (Core)

- 22.** Find a and b such that $x^4 + 4x^2 + ax + b$ is exactly divisible by $x^2 + x - 2$.
- 23.** Consider the system of equations $5^x \cdot 25^{2y} = 1$ and $3^{5x} \cdot 9^y = \frac{1}{9}$.
- (a) Show that this system of equations **imply** that $x + 4y = 0$ and $5x + 2y + 2 = 0$.
- (b) Hence solve the system of equations.
- 24.** (a) Show that $N \leq 11$, where $N = 10 + 2x - x^2$.
- (b) i. If $p^2 = 1 + p$ prove that $p^3 = 1 + 2p$.
- ii. Hence express p^5 and p^{-5} in the form $a + bp$.
- (c) Solve for x where $(1 - 2x)(2 - 3x)(3 - 4x) < 0$.
- 25.** (a) Solve the equation $8^x = 0.25^{3x-1}$.
- (b) Find the term independent of $\left(2x - \frac{1}{x}\right)^{12}$.
- (c) Factorise $P(x) = x^3 + 5x^2 + 5x - 3$.
- (d) $P(x) = (x - a)^3 + b$. Given that $x = 1$ is a zero of $P(x)$ and that when $P(x)$ is divided by x the remainder is -7 , find a and b .
- 26.** Given that $f(x) = 3 - 7x + 5x^2 - x^3$,
- (a) show that $(3 - x)$ is a factor of $f(x)$.
- (b) factorise $f(x)$ completely.
- (c) find $\{x | f(x) > 0\}$.
- 27.** (a) Find k if the equation $x^2 - (k + 3)x + (k + 6) = 0$ has no real roots.
- (b) Find the constants p and q such that $(x - 2)$ is a common factor to both the polynomials $x^3 - x^2 - 2px + 3q$ and $qx^3 - px^2 + x + 2$.
- (c) Find i. $\left\{x \mid \frac{2}{x+1} > \frac{x}{x+6}\right\}$. ii. $\left\{x \mid \frac{x+4}{x-1} < 1\right\}$.
- 28.** Given that n is a positive integer and that a and b are real constants, find a and b if
- $$(1 + ax)^n = 1 - 6x + \frac{81}{5}x^2 + bx^3 + \dots$$
- 29.** (a) i. Show that if $a + \frac{1}{a} = \frac{10}{3}$ then $3a^2 - 10a + 3 = 0$.
- ii. Hence find $\left\{x \mid 3^x + 3^{-x} = \frac{10}{3}\right\}$.
- (b) i. Find an expression for y in terms of x , if $\log 6 + \log(x - 3) = 2\log y$.
- ii. Solve the system of equations
$$\begin{aligned} \log 6 + \log(x - 3) &= 2\log y \\ 2y - x &= 3 \end{aligned}$$
.
- 30.** Find the term of x^5 in the expansion $(1 + 2x)^8$.

- 31.** Solve for x : (a) $|2x - 1| = 4$
 (b) $(2x - 1)^2 = 4$
 (c) $\log_2(2x - 1) = 4$

- 32.** Write down the largest possible domain and range for the following functions
 (a) $f(x) = |4 - x|$ (b) $g(x) = \sqrt{4 - x}$ (c) $h(x) = \log_a(4 - x)$

- 33.** ABCD is a square of side length one unit. Points E and F are taken on [AB] and [AD] respectively such that $AE = AF = x$.

- (a) Show that the area, y sq units, of the quadrilateral CDFE is given by

$$y = \frac{1}{2}(1 + x - x^2).$$

- (b) Find the maximum area of the quadrilateral.

- 34.** The diagram shows a sketch of the part of the graph of $y = f(x)$ for $0 \leq x \leq 2c$. The line $x = 2c$ is a line of symmetry of the graph. Sketch on separate axes the graphs of

- i. $y = f(x)$, for $0 \leq x \leq 4c$,
 ii. $y = f(x - c)$, for $2c \leq x \leq 4c$.

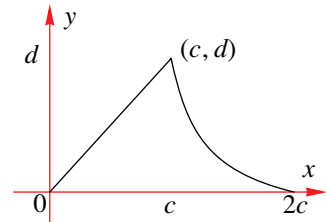

- 35.** (a) On the same set of axes, sketch the graphs of each of the following
 i. $y = x^2 - 2x + 2$ ii. $y = \frac{1}{x^2 - 2x + 2}$
 (b) Rumours of an imminent take-over by a large electronics company has forced the value of shares in Smith Electronics to rise. Unfortunately, only one week after the rumour started, the large electronics company declared that the take-over would **not** take place. The value of shares in Smith electronics t weeks after the rumour started can be represented by

$$V(t) = \frac{400}{t^2 - 2t + 2}, t \geq 0.$$

where $V(t)$ is measured in cents.

- i. Sketch the graph of the function V .
 ii. What was the value of shares in Smith Electronics before the rumour started?
 iii. What is the maximum value that shares in Smith Electronics reaches?
 iv. Mr Brown bought shares in Smith Electronics before the rumour of a take-over. If he is prepared to sell them at 50% profit, when should he sell his shares?
- 36.** (a) On the same set of axes, sketch the graphs of $f : [0, a] \mapsto \mathbb{R}$, where $f(x) = \frac{1}{3}x^2$ and $g : [0, a] \mapsto \mathbb{R}$, where $g(x) = 4x - x^2$, where $a > 0$ and $g(a) = f(a)$.
 (b) Find a .

- 37.** Find and sketch the inverse of $g(x) = \frac{1}{2}\log_e(x - e)$, $x > e$.

- 38.** The minimum value of the function, $f(x) = ax \log_e(bx)$ is $-\frac{a}{be}$, $a > 0, b > 0$.
- State the
 - maximal domain of f .
 - range of f .
 - Sketch the graph of f , giving the coordinates of the x -intercept.
 - Find the coordinates of the point where the graph of f meets the straight line with equation $y = (a \log_e b)x$.
 - Find the relationship between b and x at the point where the graph of f meets the straight line with equation $y = a \log_e b$.

- 39.** A biologist is observing the growth of two bacterial cultures during an experiment on a new drug. After a number of experiments the biologist observes that the growth of one culture and the decrease in the other culture can be approximated by mathematical functions.

$A(t)$ is the number of cells in the first culture after t hours. The number of cells started with in this culture is 900 and the biologist notes that all the cells have died after 5 hours.

$B(t)$ is the number of cells in the second culture after t hours and grows according to the function, $B(t) = \frac{1000}{1 + 49e^{-2t}}$.

- If $A(t)$ is a function of the form $at^2 + b$, find the values of a and b .
- Copy and complete the table for t and $B(t)$.

t	1	2	3.5	5
$B(t)$				

- What is the initial number of cells for the second culture?
- As time increases, what is the *limiting* value of the number of cells for $B(t)$?
- After what time is the number of cells in the second culture greater than 500?
- Using the same diagram, draw the graphs of $A(t)$ and $B(t)$.

- 40.** The water tank shown is used to top up the level of water in a bird pond. The tank is initially full. When the tap is opened, water flows from a hose connected to the bottom of the tank into the bird pond. The height of the water in the tank, h cm, at a time t hours after the tap has been opened is modelled by the function h , with the rule

$$h(t) = (0.13t - 12.25)^2$$

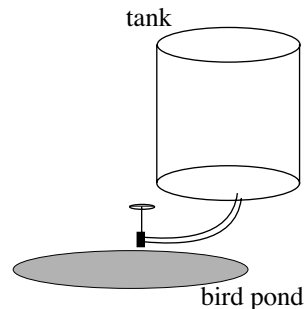

- What is the initial height of water in the tank?
- What is the value of h after 4 hours?
- When, to the nearest hour, will the tank be empty if water is allowed to continue to flow out?
- Give the maximal domain and range for the function h .
- Explain briefly why an inverse function, h^{-1} exists. Find its rule and domain.
- On the same set of axes, draw the graphs of h and h^{-1} .
- When (to the nearest 0.1 of an hour) will the tank be two-thirds full?

$$x + y - z = 9$$

- 41.** Solve the system of equations $3x + 4y + 3z = 2$.

$$4x + 5y + 3z = 5$$

42. Let $f(x) = \begin{cases} 1 & x < 0 \\ 2 - x & 0 \leq x \leq 1 \\ x^{-1} & x > 1 \end{cases}$

- (a) Sketch the graph of f .
 (b) State the range of f .
 (c) Is f a continuous function?

- 43.** Find the coefficient of x^4 in the expansion of $(1 + x + x^2)(1 - x)^9$.

- 44.** Let functions f and g be defined by $f : [-1, 1] \mapsto \mathbb{R}$, where $f(x) = \sqrt{1 - x^2}$ and $g : [a, b] \mapsto \mathbb{R}$, where $g(x) = 1 - x^2$.

- (a) If a is a negative real number, what is the greatest real number b such that g has an inverse function?
 (b) What is the least value of a for which $f \circ g$ exist?
 (c) If a and b have the values found in (a) and (b), state, with reason, whether or not $g \circ f$ exists.

- 45.** Find the middle term in the expansion of $\left(x^2 - \frac{1}{2x}\right)^{10}$.

- 46.** (a) Find the inverse, g^{-1} of $g(x) = x^2 + 2x + 3$, $x \geq -1$.
 (b) On the same set of axes, sketch the graphs of $g(x)$ and $g^{-1}(x)$.
 (c) Will there exist a value of x for which $g(x) = g^{-1}(x)$?
 If so, find it.

- 47.** Let $f : \mathbb{R} \mapsto \mathbb{R}$ where $f(x) = 4 - x^2$ and $g : [0, \infty[\mapsto \mathbb{R}$, where $g(x) = \sqrt{x}$
 i. Show that one of the $f \circ g$ and $g \circ f$ exists but the other does not.
 ii. If h is the one which does exist, define h and state its range.

- 48.** A function f is defined by $f : \mathbb{R} \mapsto \mathbb{R}$, where $f(x) = 1 - e^{-x}$
 i. Sketch the graph of f and show that an inverse function f^{-1} exists.
 ii. Find the domain of f^{-1} and find $f^{-1}(x)$.
 iii. Sketch the graph of f^{-1} on the same set of axes as the graph of f .

- 49.** Find the coefficient of x^3 in the expansion of $(1 - x)^5(1 + x)^7$.

- 50.** Solve completely the following system of linear equations
$$\begin{cases} 3x + y + 2z = 0 \\ -2x + 3y - z = 0 \end{cases}$$

MATHEMATICS – Higher Level (Core)

- 51.** (a) Let $f(x) = x^2$ and $g:]-\infty, 3[\mapsto \mathbb{R}$, where $g(x) = \sqrt{3-x}$. State, with reasons, whether or not $f \circ g$ and $g \circ f$ exist.
- (b) Find all real values of x for which $\log_e(\log_e(x^2 - 3))$ is real.

$$x + y = 2$$

- 52.** Solve the simultaneous equations $x - y - z = -5$.

$$x + 3y + z = 9$$

- 53.** (a) Solve the simultaneous equations $2x + 3y + z = 6$.
- $$4x + 7y - z = 10$$

- (b) Let $f: S \mapsto \mathbb{R}$, where $f(x) = \log_e\left(\frac{2-x}{3+x}\right)$. If S is the set of all real values of x for which $f(x)$ is defined, find S .

- 54.** (a) Let $f: [0, \infty[\mapsto \mathbb{R}$, where $f(x) = 2 - \sqrt{x}$. Define the inverse function f^{-1} .
- (b) Let $g: [0, \infty[\mapsto \mathbb{R}$, where $g(x) = \sqrt{x}$. Explain why one of $f^{-1} \circ g$ and $g \circ f^{-1}$ is defined and one is not.
- (c) If F is the one which is defined, find $F(x)$ and sketch the graph of F .

$$x - y - 2z = -3$$

- 55.** (a) Find the two values of t for which the system of equations $tx + y - z = 3t$ does
- $$x + 3y + tz = 13$$

not have a unique solution for x, y and z .

- (b) Show that, for one of these values of t , no solution exists.
- (c) For the other value of t , find the solution set.

- 56.** When a colony of wasps was studied, its population was found to be approximated by the model $P(t) = 50e^{0.1t}$, $t \geq 0$, where P is the population of wasps, and t days is the time from the start of the study.

- (a) i. What was the population of the wasp colony when the study began?
ii. What was the population of the wasp colony 10 days after the study began?
- (b) Sketch, on a set of axes, a graph of the population P against the time t .
- (c) In a sentence, describe how the population of the wasp colony was changing.

Over the same period of time a second wasp colony was also studied. Its population, Q , was found to be approximated by the model $Q(t) = 500 - 450e^{-0.1t}$, $t \geq 0$.

- (d) i. What was the population of this second colony when the study began?
ii. What was its population 10 days after the study began?
- (e) On the same set of axes as (b), sketch the graph of the population Q against time.
- (f) In a sentence, describe how the population of the wasp colony was changing.
- (g) Using your graph, estimate the population when the populations of the two wasp colonies are the same.
- (h) i. By solving an appropriate equation, show that when the two wasp colonies have equal numbers, then $k^2 - 10k + 9 = 0$ where $k = e^{0.1t}$.
ii. Hence, find the exact time when the two wasp colonies have equal numbers.

8.1 ARITHMETIC SEQUENCES & SERIES

8.1.1 ARITHMETIC SEQUENCES

A **sequence** is a set of quantities arranged in a definite order.

$$1, 2, 3, 4, 5, 6, \dots \quad -1, 2, -4, 8, -16, \dots, 1, \quad 1, 2, 3, 5, 8, 13, \dots$$

are all examples of sequences. When the terms of a sequence are added, we obtain a series. Sequences and series are used to solve a variety of practical problems in, for example, business.

There are two major types of sequence, **arithmetic** and **geometric**. This section will consider arithmetic sequences (also known as arithmetic progressions, or simply A.P). The characteristic of such a sequence is that there is a common difference between successive terms. For example:

1, 3, 5, 7, 9, 11, ... (the odd numbers) has a first term of 1 and a common difference of 2.
18, 15, 12, 9, 6, ... has a first term of 18 and a common difference of -3 (sequence is decreasing).

The terms of a sequence are generally labelled $u_1, u_2, u_3, u_4, \dots, u_n$. The '***n*th term**' of a sequence is labelled u_n . In the case of an arithmetic sequence which starts with a and has a **common difference** of d , the ***n*th term** can be found using the formula:

$$u_n = a + (n - 1)d \quad \text{where } d = u_2 - u_1 = u_3 - u_2 = \dots$$

EXAMPLE 8.1

For the sequence 7, 11, 15, 19, ..., find the 20th term.

S
O
L
U
T
I
O
N

In this case $a = 7$ and $d = 4$ because the sequence starts with a 7 and each term is 4 bigger than the one before it, i.e., $d = 11 - 7 = 4$. Therefore the n th term is given by

$$u_n = 7 + (n - 1) \times 4$$

That is, $u_n = 4n + 3$

$$\therefore u_{20} = 4 \times 20 + 3 = 83 \quad [n = 20 \text{ corresponds to the 20th term}]$$

EXAMPLE 8.2

An arithmetic sequence has a first term of 120 and a 10th term of 57. Find the 15th term.

S
O
L
U
T
I
O
N

The data is: $a = 120$ and when $n = 10$, $u_{10} = 57$ [i.e., 10th term is 57].

This gives, $u_{10} = 120 + (10 - 1)d = 57 \Leftrightarrow 120 + 9d = 57$

$$\therefore d = -7$$

Using $u_n = a + (n - 1)d$, we then have $u_n = 120 + (n - 1) \times (-7) = 127 - 7n$.

MATHEMATICS – Higher Level (Core)

Therefore, when $n = 15$, $u_{15} = 127 - 7 \times 15 = 22$.

EXAMPLE 8.3

An arithmetic sequence has a 7th term of 16.5 and a 12th term of 24. Find the 24th term.

Solution

In this instance we know neither the first term nor the common difference and so we will need to set up equations to be solved simultaneously.

The data is: $u_7 = a + 6d = 16.5$ – (1)

$$u_{12} = a + 11d = 24$$
 – (2)

We first solve for ‘ d ’: (2) – (1): $5d = 7.5 \Leftrightarrow d = 1.5$

Substituting into (1): $a + 6 \times 1.5 = 16.5 \Leftrightarrow a = 7.5$

To find the 24th term we use the general term $u_n = a + (n - 1)d$ with $n = 24$:

$$u_{24} = 7.5 + (24 - 1) \times 1.5 = 42$$

EXAMPLE 8.4

A car whose original value was \$25600 decreases in value by \$90 per month. How long will it take before the car’s value falls below \$15000?

Solution

The values can be seen as a sequence: \$25600, \$25510, \$25420 etc.

In this case $a = 25600$ and $d = 25510 - 25600 = -90$ so that:

$$u_n = 25600 + (n - 1) \times (-90)$$

$$= 25690 - 90n$$

$$\therefore 15000 = 25690 - 90n$$

$$\Leftrightarrow 90n = 25690 - 15000$$

$$\Leftrightarrow n = 118.777$$

The car will be worth less than \$15000 after 119 months

Using a Graphics Calculator

Most graphic calculators have an automatic memory facility (usually called **Ans**) that stores the result of the last calculation as well as an ability to remember the actual calculation. This can be very useful in listing a sequence.

EXAMPLE 8.5

List the arithmetic sequence 5, 12, 19, 26,.....

The sequence has a first term of 5. Enter this and press **ENTER** or **EXE**.

The common difference of the sequence is 7 so enter + 7. The display will show Ans + 7 which means ‘add 7 to the previous answer.

From here, every time you press **ENTER** (or **EXE**), you will repeat the calculation, generating successive terms of the sequence.

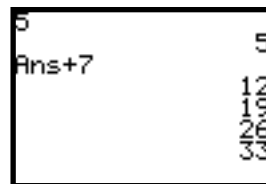

However, the TI-83 is much more sophisticated than this. It is possible to set up a sequence rule on the TI-83. To do this we use the **MODE** key to switch to **Seq** mode and this changes the Equation editor screen from **Y=** to a sequence version (instead of the usual function form).

There are three sequence forms; $u(n)$, $v(n)$ and $w(n)$, which can be accessed on the home screen using the 2nd function key with 7, 8 and 9 respectively. Once these equations are defined we can plot their sequence graph.

We now consider Example 8.2, where we obtained the sequence $u_n = 127 - 7n$ and wished to determine the 15th term.

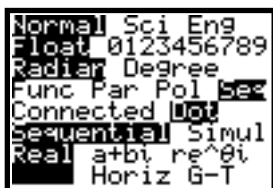

Setting into sequence mode

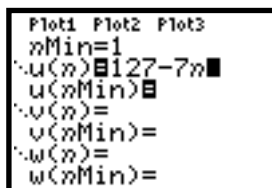

Define sequence equation

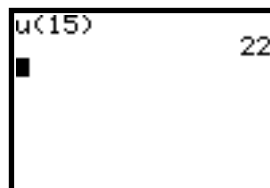
Use 2nd key '7' to call up u .

We can also use other features of the TI-83. For example, set up the sequence in a table format:



n	$u(n)$
1	120
2	113
3	106
4	99
5	92
6	85
7	78

$u(n)=120$

We can plot the sequence:

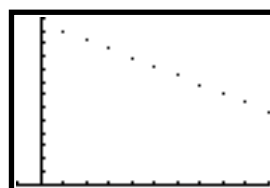
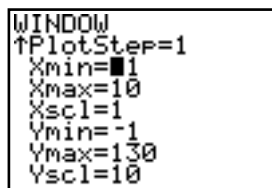
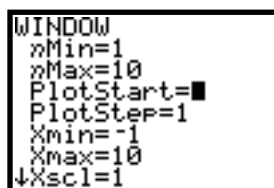

The TI-83 has many features that can be used with sequences. Become familiar with all of them.

EXERCISES 8.1.1

1. (a) Show that the following sequences are arithmetic.
 (b) Find the common difference.
 (c) Define the rule that gives the n th term of the sequence.

i. $\{2, 6, 10, 14, \dots\}$	ii. $\{20, 17, 14, 11, \dots\}$
iii. $\{1, -4, -9, \dots\}$	iv. $\{0.5, 1.0, 1.5, 2.0, \dots\}$
v. $\{y + 1, y + 3, y + 5, \dots\}$	vi. $\{x + 2, x, x - 2, \dots\}$

2. Find the 10th term of the sequence whose first four terms are 8, 4, 0, -4.

3. Find the value of x and y in the arithmetic sequence $\{5, x, 13, y, \dots\}$.

4. An arithmetic sequence has 12 as its first term and a common difference of -5 . Find its 12th term.

5. An arithmetic sequence has -20 as its first term and a common difference of 3. Find its 10th term.

6. The 14th term of an arithmetic sequence is 100. If the first term is 9, find the common difference.

7. The 10th term of an arithmetic sequence is -40 . If the first term is 5, find the common difference.

8. If $n + 5$, $2n + 1$ and $4n - 3$ are three consecutive terms of an arithmetic sequences, find n .

9. The first three terms of an arithmetic sequence are 1, 6, 11.
 - (a) Find the 9th term.
 - (b) Which term will equal 151?

10. Find x and y given that $4 - \sqrt{3}$, x , y and $2\sqrt{3} - 2$ are the first four terms of an arithmetic sequence.

11. For each of the following sequences

(a) $u_n = -5 + 2n, n \geq 1.$	(b) $u_n = 3 + 4(n + 1), n \geq 1.$
--------------------------------	-------------------------------------

 determine
 - i. its common difference
 - ii. its first term

12. The third and fifth terms of an A.P are $x + y$ and $x - y$ respectively. Find the 12th term.

13. The sum of the fifth term and twice the third of an arithmetic sequence equals the twelfth term. If the seventh term is 25 find an expression for the general term, u_n .

14. For a given arithmetic sequence, $u_n = m$ and $u_m = n$. Find
 - (a) the common difference.
 - (b) u_{n+m} .

8.1.2 ARITHMETIC SERIES

If the **terms of a sequence are added**, the result is known as a **series**.

The sequence: $1, 2, 3, 4, 5, 6, \dots$
 gives the series: $1 + 2 + 3 + 4 + 5 + 6 + \dots$

and the sequence: $-1, -2, -4, -8, -16, \dots$
 gives the series: $(-1) + (-2) + (-4) + (-8) + (-16) + \dots$
 [or $-1 - 2 - 4 - 8 - 16 - \dots$]

The sum of the terms of a series is referred to as S_n , the **sum of n terms of a series**.

For an arithmetic series, we have

$$\begin{aligned} S_n &= u_1 + u_2 + u_3 + \dots + u_n \\ &= a + (a + d) + (a + 2d) + \dots + a + (n - 1)d \end{aligned}$$

For example, if we have a sequence defined by $u_n = 6 + 4n$, $n \geq 1$, then the sum of the first 8 terms is given by

$$\begin{aligned} S_8 &= u_1 + u_2 + u_3 + \dots + u_8 \\ &= 10 + 14 + 18 + \dots + 38 \\ &= 192 \end{aligned}$$

```
seq(6+4n,n,1,8)
(10 14 18 22 26...
Ans→L1
(10 14 18 22 26...
sum(L1)
192
```

Again, the screen display of the TI-83 shows how readily we can obtain the sum. Once the sequence has been stored as a **List**, use the **sum**(operation to obtain the answer.

There will be many cases in which we can add the terms of a series in this way. If, however, there are a large number of terms to add, a formula is more appropriate.

There is a story that, when the mathematician Gauss was a child, his teacher was having problems with him because he always finished all his work long before the other students. In an attempt to keep Gauss occupied for a period, the teacher asked him to add all the whole numbers from 1 to 100.

‘5050’ Gauss replied immediately.

It is probable that Gauss used a method similar to this:

$$\begin{array}{cccccccccccc} 1 & 2 & 3 & 4 & 5 & 6 & \dots, & 96 & 97 & 98 & 99 & 100 \\ \hline 100 & 99 & 98 & 97 & 96 & 95 & \dots, & 5 & 4 & 3 & 2 & 1 \\ \hline 101 & 101 & 101 & 101 & 101 & 101 & \dots, & 101 & 101 & 101 & 101 & 101 \end{array}$$

Adding each of the pairings gives 100 totals of 101 each. This gives a total of 10100. This is the sum of two sets of the numbers $1 + 2 + 3 + \dots + 98 + 99 + 100$ and so dividing the full answer by 2 gives the answer 5050, as the young Gauss said, 5050.

It is then possible to apply the same approach to such a sequence, bearing in mind that the sequence of numbers must be arithmetic.

EXAMPLE 8.8

An arithmetic series has a third term of 0. The sum of the first 15 terms is –300. What is the first term and the sum of the first ten terms?

S
o
l
u
t
i
o
n

From the given information we have: $u_3 = a + 2d = 0$ – (1)

$$\&: S_{15} = \frac{15}{2}[2a + 14d] = -300$$

$$\text{i.e., } 15a + 105d = -300$$

$$\therefore a + 7d = -20$$
 – (2)

The pair of equations can now be solved simultaneously:

$$(2) - (1): 5d = -20 \Leftrightarrow d = -4$$

Substituting result into (1) we have: $a + 2 \times -4 = 0 \Leftrightarrow a = 8$

This establishes that the series is $8 + 4 + 0 + (-4) + (-8) + \dots$

So the first term is 8 and the sum of the first ten terms is $S_{10} = \frac{10}{2}[16 + 9 \times -4] = -100$.

Using the TI-83 we have, using the

general term $u_n = 8 + (n - 1) \times -4 = 12 - 4n$

```
seq(12-4n,n,1,10
)
(8 4 0 -4 -8 -1...
Ans→L1
(8 4 0 -4 -8 -1...
sum(L1)
-100
```

EXAMPLE 8.9

A new business is selling home computers. They predict that they will sell 20 computers in their first month, 23 in the second month, 26 in the third and so on, in arithmetic sequence. How many months will pass before the company expects to sell their thousandth computer.

S
o
l
u
t
i
o
n

The series is: $20 + 23 + 26 + \dots$

The question implies that the company is looking at the **total** number of computers sold, so we are looking at a series, not a sequence.

The question asks how many terms (months) will be needed before the total sales reach more than 1000. From the given information we have: $a = 20$, $d = 23 - 20 = 3$.

Therefore, we have the sum to n terms given by $S_n = \frac{n}{2}[2 \times 20 + (n - 1) \times 3]$

$$= \frac{n}{2}[3n + 37]$$

Next, we determine when $S_n = 1000$: $\frac{n}{2}[3n + 37] = 1000 \Leftrightarrow 3n^2 + 37n = 2000$

$$\Leftrightarrow 3n^2 + 37n - 2000 = 0$$

We solve for n use either of the following methods:

Method 1: Quadratic formula

$$\begin{aligned} n &= \frac{-37 \pm \sqrt{37^2 - 4 \times 3 \times -2000}}{2 \times 3} \\ &= 20.37 \text{ or } (-32.7) \end{aligned}$$

Method 2: Graphics Calculator **Solve** function

```
solve(3X^2+37X-2000,X,20)
20.37941486
```

Method 3: Table of values

```

Plot1 Plot2 Plot3
xMin=1
u(n)=n(3n+37)/2
u(xMin)=
v(n)=
v(xMin)=
w(n)=
    
```

```

TABLE SETUP
TblStart=
ΔTbl=1
Indent: Auto Ask
Depend: Auto Ask
    
```

n	u(n)
18	819
19	893
20	970
21	1050
22	1133
23	1219
24	1308
n=21	

← $S_{21} > 1000$

Notice that we have entered the expression for S_n as the sequence rule for $u(n)$. In fact, the series itself is made up of terms in a sequence of so-called **partial sums**, often called a **sum sequence**. That is, we have that $\{S_1, S_2, S_3, \dots\} = \{15, 33, 54, \dots\}$ forms a sequence.

The answer then, is that the company will sell its thousandth computer during the 20th month.

EXERCISES 8.1.2

1. Find the sum of the first ten terms in the arithmetic sequences
 (a) $\{1, 4, 7, 10, \dots\}$ (b) $\{3, 9, 15, 21, \dots\}$ (c) $\{10, 4, -2, \dots\}$.

2. For the given arithmetic sequences, find the sum, S_n , to the requested number of terms.
 (a) $\{4, 3, 2, \dots\}$ for $n = 12$
 (b) $\{4, 10, 16, \dots\}$ for $n = 15$
 (c) $\{2.9, 3.6, 4.3, \dots\}$ for $n = 11$

3. Find the sum of the following sequences:
 (a) $\{5, 4, 3, \dots, -15\}$
 (b) $\{3, 9, 15, \dots, 75\}$
 (c) $\{3, 5, 7, \dots, 29\}$

4. The weekly sales of washing machines from a retail store that has just opened in a new housing complex increases by 2 machines per week. In the first week of January 1995, 24 machines were sold.
 (a) How many are sold in the last week of December 1995?
 (b) How many machines did the retailer sell in 1995?
 (c) When was the 500th machine sold?

5. The fourth term of an arithmetic sequence is 5 while the sum of the first 6 terms is 10. Find the sum of the first nineteen terms.

6. Find the sum of the first 10 terms for the sequences defined by
 (a) $u_n = -2 + 8n$ (b) $u_n = 1 - 4n$

7. The sum of the first eight terms of the sequence $\{\ln x, \ln x^2 y, \ln x^3 y^2, \dots\}$ is given by $4(a \ln x + b \ln y)$. Find a and b .

8.1.3 SIGMA NOTATION

There is a second notation to denote the sum of terms. This other notation makes use the Greek letter Σ ... as the symbol to inform us that we are carrying out a summation.

In short, Σ ... stands for ‘**The sum of ...**’.

This means that the expression $\sum_{i=1}^n u_i = u_1 + u_2 + u_3 + \dots + u_{n-1} + u_n$.

For example, if $u_i = 2 + 5(i - 1)$, i.e., an A.P with first term $a = 2$ and common difference $d = 5$,

the expression $S_n = \sum_{i=1}^n [2 + 5(i - 1)]$ would represent the sum of the first n terms of the sequence. So, the sum of the first 3 terms would be given by

$$\begin{aligned} S_3 &= \sum_{i=1}^3 [2 + 5(i - 1)] = \underbrace{[2 + 5(1 - 1)]}_{i=1} + \underbrace{[2 + 5(2 - 1)]}_{i=2} + \underbrace{[2 + 5(3 - 1)]}_{i=3} \\ &= 2 + 7 + 12 \\ &= 21 \end{aligned}$$

Properties of Σ

1. Σ is distributive. That is, $\sum_{i=1}^n [u_i + v_i] = \sum_{i=1}^n u_i + \sum_{i=1}^n v_i$.

2. $\sum_{i=1}^n k u_i = k \sum_{i=1}^n u_i$, for some constant value k .

3. $\sum_{i=1}^n k = kn$, i.e., adding a constant term, k , n times is the same as multiplying k by n .

EXAMPLE 8.10

Given that $u_i = 5 + 2i$ and that $v_i = 2 - 5i$ find

(a) $\sum_{i=1}^5 u_i$ (b) $\sum_{i=1}^5 [2u_i - v_i]$ (c) $\sum_{i=1}^{1000} [5u_i + 2v_i]$

S
o
l
u
t
i
o
n

(a) $\sum_{i=1}^5 u_i = u_1 + u_2 + u_3 + u_4 + u_5 = [5 + 2] + [5 + 4] + [5 + 6] + [5 + 8] + [5 + 10]$
 $= 7 + 9 + 11 + 13 + 15$
 $= 55$

(b) $\sum_{i=1}^5 [2u_i - v_i] = \sum_{i=1}^5 (2u_i) + \sum_{i=1}^5 (-v_i) = 2 \sum_{i=1}^5 u_i - \sum_{i=1}^5 v_i$

MATHEMATICS – Higher Level (Core)

$$\text{Now, } 2 \sum_{i=1}^5 u_i = 2 \times 55 = 110$$

$$\text{and } \sum_{i=1}^5 v_i = \sum_{i=1}^5 (2 - 5i) = \sum_{i=1}^5 (2) - 5 \sum_{i=1}^5 i = 2 \times 5 - 5[1 + 2 + 3 + 4 + 5] \quad [\text{Using properties}]$$
$$= -65$$

$$\text{Therefore, } \sum_{i=1}^5 [2u_i - v_i] = 110 - (-65) = 175$$

$$\begin{aligned} \text{(c) } \sum_{i=1}^{1000} [5u_i + 2v_i] &= \sum_{i=1}^{1000} [5(5 + 2i) + 2(2 - 5i)] \\ &= \sum_{i=1}^{1000} [25 + 10i + 4 - 10i] \\ &= \sum_{i=1}^{1000} 29 \\ &= 29\,000 \quad [\text{i.e., } 29 \times 1000] \end{aligned}$$

In this example we have tried to show that there are a number of ways to obtain a sum. It is not always necessary to enumerate every term and then add them. Often, an expression can first be simplified.

EXERCISES 8.1.3 – MISCELLANEOUS QUESTIONS

1. Find the twentieth term in the sequence 9, 15, 21, 27, 33, ...
2. Fill the gaps in this arithmetic sequence: -3, _, _, _, _, 12.
3. An arithmetic sequence has a tenth term of 17 and a fourteenth term of 30. Find the common difference.
4. If $u_{59} = \frac{1}{10}$ and $u_{100} = -1\frac{19}{20}$ for an arithmetic sequence, find the first term and the common difference.
5. Find the sum of the first one hundred odd numbers.
6. An arithmetic series has twenty terms. The first term is -50 and the last term is 83, find the sum of the series.
7. Thirty numbers are in arithmetic sequence. The sum of the numbers is 270 and the last number is 38. What is the first number?
8. How many terms of the arithmetic sequence: 2, 2.3, 2.6, 2.9, ... must be taken before the terms exceed 100?

9. Brian and Melissa save \$50 in the first week of a savings program, \$55 in the second week, \$60 in the third and so on, in arithmetic progression. How much will they save in ten weeks? How long will they have to continue saving if their target is to save \$5000?
10. A printing firm offers to print business cards on the following terms: \$45 for design and typesetting and then \$0.02 per card.
 (i) What is the cost of 500 cards from this printer?
 (ii) How many cards can a customer with \$100 afford to order?
11. A children's game consists of the players standing in a line with a gap of 2 metres between each. The child at the left hand end of the line has a ball which s/he throws to the next child in the line, a distance of 2 metres. The ball is then thrown back to the first child who then throws the ball to the third child in the line, a distance of 4 metres. The ball is then returned to the first child, and so on until all the children have touched the ball at least once.

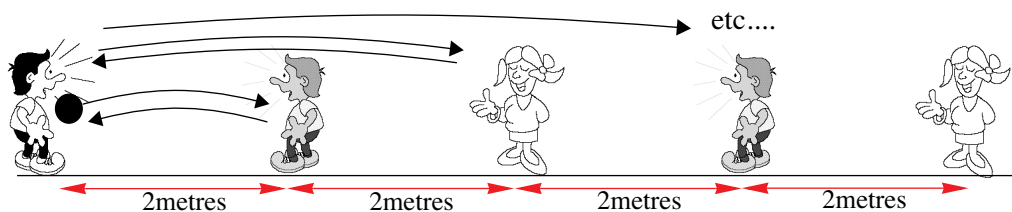

- (a) If a total of five children play and they make the least number of throws so that only the leftmost child touches the ball more than once:
 i. What is the largest single throw?
 ii. What is the total distance travelled by the ball?
- (b) If seven children play, what is the total distance travelled by the ball?
- (c) If n children play, derive a formula for the total distance travelled by the ball.
- (d) Find the least number of children who need to play the game before the total distance travelled by the ball exceeds 100 metres.
- (e) The children can all throw the ball 50 metres at most
 i. What is the largest number of children that can play the game?
 ii. What is the total distance travelled by the ball?

12. Find each sum,

(a) $\sum_{k=1}^{100} k$ (b) $\sum_{k=1}^{100} (2k + 1)$ (c) $\sum_{k=1}^{51} (3k + 5)$

13. If $u_i = -3 + 4i$ and $v_i = 12 - 3i$ find

(a) $\sum_{i=1}^{10} (u_i + v_i)$ (b) $\sum_{i=1}^{10} (3u_i + 4v_i)$ (c) $\sum_{i=1}^{10} u_i v_i$

14. (a) Show that for an arithmetic sequence, $u_n = S_n - S_{n-1}$, where u_n is the n th term and S_n is the sum of the first n terms.

(b) Find the general term, u_n , of the A.P given that $\sum_{i=1}^n u_i = \frac{n}{2}(3n - 1)$.

8.2 GEOMETRIC SEQUENCES & SERIES

8.2.1 GEOMETRIC SEQUENCES

Sequences such as 2, 6, 18, 54, 162, ... and 200, 20, 2, 0.2, ... in which each term is obtained by multiplying the previous one by a fixed quantity are known as **geometric sequences**.

The sequence: 2, 6, 18, 54, 162, ... is formed by starting with 2 and then multiplying by 3 to get the second term, by 3 again to get the third term, and so on.

For the sequence 200, 20, 2, 0.2, ... , begin with 20 and multiplied by 0.1 to get the second term, by 0.1 again to get the third term and so on.

The constant multiplier of such a sequence is known as the **common ratio**.

The common ratio of 2, 6, 18, 54, 162, ... is 3 and of 200, 20, 2, 0.2, ... it is 0.1.

The **n th term of a geometric sequence** is obtained from the first term by multiplying by $n-1$ common ratios. This leads to the formula for the

$$n\text{th term of a geometric sequence: } u_n = a \times r^{n-1} \text{ where } r = \frac{u_2}{u_1} = \dots = \frac{u_n}{u_{n-1}}$$

and n is the term number, a the first term and r is the common ratio.

EXAMPLE 8.11

Find the tenth term in the sequence 2, 6, 18, 54, 162, ...

S
o
l
u
t
i
o
n

The first term is $a = 2$. The common ratio $r = 3 = \frac{6}{2} = \frac{18}{6}$ and n , the required term, is 10.

Use the formula to solve the problem:

$$\begin{aligned} u_n &= a \times r^{n-1} \\ u_{10} &= 2 \times 3^{(10-1)} \\ &= 2 \times 3^9 \\ &= 39366 \end{aligned}$$

EXAMPLE 8.12

Find the fifteenth term in the sequence 200, 20, 2, 0.2, ...

S
o
l
u
t
i
o
n

In this case, $a = 200$, $r = \frac{20}{200} = \frac{1}{10} = 0.1$ and $n = 15$.

Using the general term $u_n = a \times r^{n-1}$, the 15th term is given by

$$\begin{aligned} u_{15} &= 200 \times 0.1^{(15-1)} \\ &= 200 \times 0.1^{14} \\ &= 2 \times 10^{-12} \end{aligned}$$

EXAMPLE 8.13

Find the eleventh term in the sequence $1, -\frac{1}{2}, \frac{1}{4}, -\frac{1}{8}, \frac{1}{16}, \dots$

**S
o
l
u
t
i
o
n**

The sequence $1, -\frac{1}{2}, \frac{1}{4}, -\frac{1}{8}, \frac{1}{16}, \dots$ has a common ratio of $r = \frac{-1/2}{1} = -\frac{1}{2}$.

$$\begin{aligned} \text{Using the general term } u_n = a \times r^{n-1}, \text{ we have } u_{11} &= 1 \times \left(-\frac{1}{2}\right)^{(11-1)} \\ &= \left(-\frac{1}{2}\right)^{10} \\ &\approx 0.000977 \end{aligned}$$

Many questions will be more demanding in terms of the way in which you use this formula. You should also recognise that the formula can be applied to a range of practical problems.

Many of the practical problems involve growth and decay and can be seen as similar to problems studied in Chapter 7.

EXAMPLE 8.14

A geometric sequence has a fifth term of 3 and a seventh term of 0.75. Find the first term, the common ratio and the tenth term.

**S
o
l
u
t
i
o
n**

From the given information we can set up the following equations:

$$\begin{aligned} u_5 &= a \times r^4 = 3 \quad \text{(1)} \\ \& \quad u_7 &= a \times r^6 = 0.75 \quad \text{(2)} \end{aligned}$$

As with similar problems involving arithmetic sequences, the result is a pair of simultaneous equations. In this case these can best be solved by dividing (2) by (1) to get:

$$\frac{a \times r^6}{a \times r^4} = \frac{0.75}{3} \Leftrightarrow r^2 = 0.25 \Leftrightarrow r = \pm 0.5$$

Substituting results into (1) we have: $a \left(\pm \frac{1}{2}\right)^4 = 3 \Leftrightarrow a = 48$

Therefore, the 10th term is given by $u_{10} = 48 \times (\pm 0.5)^9 = \pm \frac{3}{32}$

There are two solutions: 48, 24, 12, 6, ... (for the case $r = 0.5$) & 48, -24, 12, -6, ... ($r = -0.5$).

EXAMPLE 8.15

Find the number of terms in the geometric sequence:
0.25, 0.75, 2.25, ..., 44286.75.

The sequence 0.25, 0.75, 2.25, . . . , 44286.75 has a first term $a = 0.25$ and a common ratio $r = \frac{0.75}{0.25} = 3$. In this problem it is n that is unknown. Substitution of the data into the

formula gives: $u_n = 0.25 \times 3^{(n-1)} = 44286.75$

The equation that results can be solved using logarithms (see Chapter 7).

$$0.25 \times 3^{(n-1)} = 44286.75$$

$$\therefore 3^{(n-1)} = 177147$$

$$\Leftrightarrow \log_{10} 3^{(n-1)} = \log_{10} 177147$$

$$\Leftrightarrow (n-1) \log_{10} 3 = \log_{10} 177147$$

$$\Leftrightarrow n-1 = \frac{\log_{10} 177147}{\log_{10} 3}$$

$$\therefore n-1 = 11$$

$$\Leftrightarrow n = 12$$

Or, by making use of the TI-83



EXAMPLE 8.16

A car originally worth \$34000 loses 15% of its value each year.

- (a) Write a geometric sequence that gives the year by year value of the car.
- (b) Find the value of the car after 6 years.
- (c) After how many years will the value of the car fall below \$10000?

(a) If the car loses 15% of its value each year, its value will fall to 85% (100% – 15%) of its value in the previous year. This means that the common ratio is 0.85 (the fractional equivalent of 85%). Using the formula, the sequence is: $u_n = 34000 \times 0.85^{(n-1)}$ i.e. \$34000, \$28900, \$24565, \$20880.25, . . .

(b) The value after six years have passed is the **seventh** term of the sequence. This is because the first term of the sequence is the value after **no** years have passed.
 $u_7 = 34000 \times 0.85^6 \approx 12823$ or \$12823.

(c) This requires solution of the equation $10000 = 34000 \times 0.85^n$:

$$10000 = 34000 \times 0.85^n$$

$$0.85^n = 0.2941$$

$$\log_{10}(0.85^n) = \log_{10} 0.2941$$

$$n \log_{10} 0.85 = \log_{10} 0.2941$$

$$n-1 = \frac{\log_{10} 0.2941}{\log_{10} 0.85}$$

$$n \approx 7.53$$

Or, by making use of the TI-83

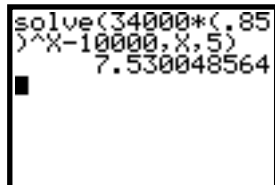

This means that the car's value will fall to \$10000 after about 7 years 6 months.

EXAMPLE 8.17

The number of people in a small country town increases by 2% per year. If the population at the start of 1970 was 12500, what is the predicted population at the start of the year 2010?

**S
o
l
u
t
i
o
n**

A quantity can be increased by 2% by multiplying by 1.02. Note that this is different from finding 2% of a quantity which is done by multiplying by 0.02.

The sequence is: 12500, 12500×1.02 , 12500×1.02^2 etc. with $a = 12500$, $r = 1.02$.

It is also necessary to be careful about which term is required. In this case, the population at the start of 1970 is the first term, the population at the start of 1971 the second term, and so on. The population at the start of 1980 is the **eleventh** term and at the start of 2010 we need the forty-first term:

$$u_{41} = 12500 \times 1.02^{40} \\ \approx 27600$$

In all such cases, you should round your answer to the level given in the question or, if no such direction is given, round the answer to a reasonable level of accuracy. In this question, the original population appears to have been given to the nearest 100 and so it is hardly reasonable to give a higher level of accuracy in the answer.

Using a Graphics Calculator

As with arithmetic sequences, geometric sequences such as 50, 25, 12.5, ... can be listed using a graphics calculator. For this sequence we have $a = 50$ and $r = 0.5$, so, $u_n = 50(0.5)^{n-1}$

We first set the **MODE** to **Seq** and then enter the sequence rule:

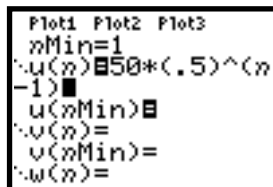
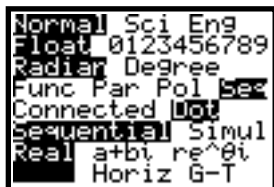

n	u(n)
1	50
2	25
3	12.5
4	6.25
5	3.125
6	1.5625
7	.78125

n=1

Plot of sequence:

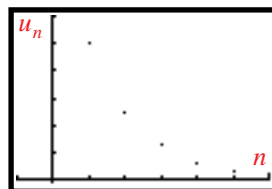

EXERCISES 8.2.1

1. Find the common ratio, the 5th term and the general term of the following sequences

- (a) 3, 6, 12, 24, ... (b) $3, 1, \frac{1}{3}, \frac{1}{9}, \dots$ (c) $2, \frac{2}{5}, \frac{2}{25}, \frac{2}{125}, \dots$
- (d) -1, 4, -16, 64, ... (e) $ab, a, \frac{a}{b}, \frac{a}{b^2}, \dots$ (f) a^2, ab, b^2, \dots

MATHEMATICS – Higher Level (Core)

- 2.** Find the value(s) of x if each of the following are in geometric sequence
- (a) 3, x , 48
- (b) $\frac{5}{2}$, x , $\frac{1}{2}$
- 3.** The third and seventh terms of a geometric sequence are $\frac{3}{4}$ and 12 respectively.
- (a) Find the 10th term.
- (b) What term is equal to 3072?
- 4.** A rubber ball is dropped from a height of 10 m and bounces to reach $\frac{5}{6}$ of its previous height after each rebound. Let u_n is the ball's maximum height **before** its n th rebound.
- (a) Find an expression for u_n .
- (b) How high will the ball bounce **after** its 5th rebound.
- (c) How many times has the ball bounced by the time it reaches a maximum height of $\frac{6250}{1296}$ m.
- 5.** The terms $k + 4$, $5k + 4$, $k + 20$ are in a geometric sequence. Find the value(s) of k .
- 6.** A computer depreciates each year to 80% of its value from the previous year. When bought the computer was worth \$8000.
- (a) Find its value after
- i. 3 years
- ii. 6 years
- (b) How long does it take for the computer to depreciate to a quarter of its purchase price.
- 7.** The sum of the first and third terms of a geometric sequence is 40 while the sum of its second and fourth terms is 96. Find the sixth term of the sequence.
- 8.** The sum of three successive terms of a geometric sequence is $\frac{35}{2}$ while their product is 125. Find the three terms.
- 9.** The population in a town of 40,000 increases at 3% per annum. Estimate the town's population after 10 years.
- 10.** Following new government funding it is expected that the unemployed workforce will decrease by 1.2% per month. Initially there are 120,000 people unemployed. How large an unemployed workforce can the government expect to report in 8 months time.
- 11.** The cost of erecting the ground floor of a building is \$44,000, for erecting the first floor it costs \$46,200, to erect the second floor costs \$48,510 and so on.
Using this cost structure
- (a) How much will it cost to erect the 5th floor?
- (b) What will be to total cost of erecting a building with six floors?

8.2.2 GEOMETRIC SERIES

When the terms of a geometric sequence are added, the result is a **geometric series**.

For example:

The sequence 3, 6, 12, 24, 48, ... gives rise to the series: $3 + 6 + 12 + 24 + 48 + \dots$

and, the sequence $24, -16, 10\frac{2}{3}, -7\frac{1}{9}, \dots$ leads to the series $24 - 16 + 10\frac{2}{3} - 7\frac{1}{9} + \dots$

Geometric series can be summed using the formula that is derived by first multiplying the series by r :

$$\begin{aligned} S_n &= a + ar + ar^2 + ar^3 + \dots + ar^{n-3} + ar^{n-2} + ar^{n-1} \\ r \times S_n &= ar + ar^2 + ar^3 + \dots + ar^{n-3} + ar^{n-2} + ar^{n-1} + ar^n \\ S_n - r \times S_n &= a - ar^n \quad (\text{subtracting the second equation from the first}) \\ S_n(1 - r) &= a(1 - r^n) \\ S_n &= \frac{a(1 - r^n)}{1 - r} \end{aligned}$$

This formula can also be written as: $S_n = \frac{a(r^n - 1)}{r - 1}$, $r \neq 1$. It is usual to use the version of the formula that gives a positive value for the denominator. And so, we have:

The sum of the first n terms of a geometric series, S_n , where $r \neq 1$ is given by

$$S_n = \frac{a(1 - r^n)}{1 - r}, |r| < 1 \quad \text{or} \quad S_n = \frac{a(r^n - 1)}{r - 1}, |r| > 1$$

EXAMPLE 8.18

Sum the following series to the number of terms indicated.

- (a) $2 + 4 + 8 + 16 + \dots$ 9 terms.
 (b) $5 - 15 + 45 - 135 + \dots$ 7 terms.
 (c) $24 + 18 + \frac{27}{2} + \frac{81}{8} + \dots$ 12 terms.
 (d) $20 - 30 + 45 - 67.5 + \dots$ 10 terms.

S
o
l
u
t
i
o
n

- (a) In this case $a = 2$, $r = 2$ and $n = 9$.
 Because $r = 2$ it is more convenient to use:

$$\begin{aligned} S_n &= \frac{a(r^n - 1)}{r - 1} \\ S_9 &= \frac{2(2^9 - 1)}{2 - 1} \\ &= 1022 \end{aligned}$$

Using this version of the formula gives positive values for the numerator and denominator. The other version is correct but gives negative numerator and denominator and hence the same answer.

MATHEMATICS – Higher Level (Core)

(b) $a = 5, r = -3$ and $n = 7$.

$$S_n = \frac{a(1-r^n)}{1-r} \qquad S_n = \frac{a(r^n-1)}{r-1}$$

$$S_7 = \frac{5(1-(-3)^7)}{1-(-3)} \qquad \text{or} \qquad S_7 = \frac{5((-3)^7-1)}{(-3)-1}$$

$$= 2735 \qquad \qquad \qquad = 2735$$

(c) $a = 24, r = 0.75$ and $n = 12$.

$$S_n = \frac{a(1-r^n)}{1-r}$$

$$S_{12} = \frac{24\left(1-\left(\frac{3}{4}\right)^{12}\right)}{1-\left(\frac{3}{4}\right)} \quad \text{This version gives the positive values.}$$

$$= 92.95907$$

(d) $a = 20, r = -1.5$ and $n = 10$.

$$S_n = \frac{a(1-r^n)}{1-r}$$

$$S_{10} = \frac{20(1-(-1.5)^{10})}{1-(-1.5)}$$

$$= -453.32031$$

When using a calculator to evaluate such expressions, it is advisable to use brackets to ensure that correct answers are obtained. For both the graphics and scientific calculator, the negative common ratio must be entered using the +/- or (-) key.

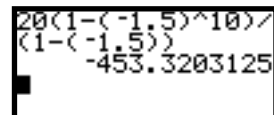

Other questions that may be asked in examinations could involve using both formulas. A second possibility is that you may be asked to apply sequence and series theory to some simple problems.

EXAMPLE 8.19

The 2nd term of a geometric series is -30 and the sum of the first two terms is -15 . Find the first term and the common ratio.

SOLUTION

From the given information we have: $u_2 = -30 \therefore ar = -30$ — (1)

$$S_2 = -15 \therefore \frac{a(r^2-1)}{r-1} = -15$$
 — (2)

The result is a pair of simultaneous equations in the two unknowns. The best method of solution is substitution:

From (1): $a = \frac{-30}{r}$. Substituting into (2): $\frac{-30}{r}(r^2-1) = -15 \Leftrightarrow \frac{(-30)(r^2-1)}{r(r-1)} = -15$

$$\begin{aligned} \therefore \frac{-30(r+1)(\cancel{r-1})}{r(\cancel{r-1})} &= -15 \\ \Leftrightarrow -30(r+1) &= -15r \\ \Leftrightarrow -30r - 30 &= -15r \\ \Leftrightarrow r &= -2 \\ \therefore a &= \frac{-30}{r} = \frac{-30}{-2} = 15 \end{aligned}$$

The series is $15 - 30 + 60 - 120 + 240 - \dots$ which meets the conditions set out in the question.

EXAMPLE 8.20

A family decide to save some money in an account that pays 9% annual compound interest calculated at the end of each year. They put \$2500 into the account at the beginning of each year. All interest is added to the account and no withdrawals are made. How much money will they have in the account on the day after they have made their tenth payment?

S
o
l
u
t
i
o
n

The problem is best looked at from the last payment of \$2500 which has just been made and which has not earned any interest.

The previous payment has earned one lot of 9% interest and so is now worth 2500×1.09 .

The previous payment has earned two years' worth of compound interest and is worth 2500×1.09^2 .

This process can be continued for all the other payments and the various amounts of interest that each has earned. They form a geometric series:

Last payment	First payment
$2500 + 2500 \times 1.09 + 2500 \times 1.09^2 + \dots + 2500 \times 1.09^9$	

The total amount saved can be calculated using the series formula:

$$\begin{aligned} S_n &= \frac{a(r^n - 1)}{r - 1} \\ S_{10} &= \frac{2500(1.09^{10} - 1)}{1.09 - 1} \\ &= 37982.32 \end{aligned}$$

The family will save about \$37,982.

EXERCISES 8.2.2

1. Find the common ratios of these geometric sequences:

(a) $7, 21, 63, 189, \dots$ (b) $12, 4, \frac{4}{3}, \frac{4}{9}, \dots$ (c) $1, -1, 1, -1, 1, \dots$

(d) $9, -3, 1, -\frac{1}{3}, \frac{1}{9}, \dots$ (e) $64, 80, 100, 125, \dots$ (f) $27, -18, 12, -8, \dots$

MATHEMATICS – Higher Level (Core)

2. Find the term indicated for each of these geometric sequences:

(a) 11, 33, 99, 297, ... 10th term. (b) 1, 0.2, 0.04, 0.008, ... 15th term.

(c) 9, -6, 4, $-\frac{8}{3}$, ... 9th term. (d) 21, 9, $\frac{27}{7}$, $\frac{81}{49}$, ... 6th term.

(e) $-\frac{1}{3}$, $-\frac{1}{4}$, $-\frac{3}{16}$, $-\frac{9}{64}$, ... 6th term.

3. Find the number of terms in each of these geometric sequences and the sum of the numbers in each sequence:

(a) 4, 12, 36, ..., 236196 (b) 11, -22, 44, ..., 704

(c) 100, -10, 1, ..., -10^{-5} (d) 48, 36, 27, ..., $\frac{6561}{1024}$

(e) $\frac{1}{8}$, $-\frac{9}{32}$, $\frac{81}{128}$, ..., $\frac{6561}{2048}$ (f) 100, 10, 1, ..., 10^{-10}

4. Write the following in expanded form and evaluate.

(a) $\sum_{k=1}^7 \left(\frac{1}{2}\right)^k$ (b) $\sum_{i=1}^6 2^{i-4}$ (c) $\sum_{j=1}^4 \left(\frac{2}{3}\right)^j$

(d) $\sum_{s=1}^4 (-3)^s$ (e) $\sum_{t=1}^6 2^{-t}$

5. The third term of a geometric sequence is 36 and the tenth term is 78,732. Find the first term in the sequence and the sum of these terms.

6. A bank account offers 9% interest compounded annually. If \$750 is invested in this account, find the amount in the account at the end of the twelfth year.

7. When a ball is dropped onto a flat floor, it bounces to 65% of the height from which it was dropped. If the ball is dropped from 80 cm, find the height of the fifth bounce.

8. A computer loses 30% of its value each year.

(a) Write a formula for the value of the computer after n years.

(b) How many years will it be before the value of the computer falls below 10% of its original value?

9. A geometric sequence has a first term of 7 and a common ratio of 1.1. How many terms must be taken before the value of the term exceeds 1000?

10. A colony of algae increases in size by 15% per week. If 10 grams of the algae are placed in a lake, find the weight of algae that will be present in the lake after 12 weeks. The lake will be considered 'seriously polluted' when there is in excess of 10000 grams of algae in the lake. How long will it be before the lake becomes seriously polluted?

11. A geometric series has nine terms, a common ratio of 2 and a sum of 3577. Find the first term.

- 12.** A geometric series has a third term of 12, a common ratio of $-\frac{1}{2}$ and a sum of $32\frac{1}{16}$. Find the number of terms in the series.
- 13.** A geometric series has a first term of 1000, seven terms and a sum of $671\frac{7}{8}$. Find the common ratio.
- 14.** A geometric series has a third term of 300, and a sixth term of 37500. Find the common ratio and the sum of the first fourteen terms (in scientific form correct to two significant figures).
- 15.** A \$10000 loan is offered on the following terms: 12% annual interest on the outstanding debt calculated monthly. The required monthly repayment is \$270. How much will still be owing after nine months.
- 16.** As a prize for inventing the game of chess, its originator is said to have asked for one grain of wheat to be placed on the first square of the board, 2 on the second, 4 on the third, 8 on the fourth and so on until each of the 64 squares had been covered. How much wheat would have been the prize?

8.2.3 COMBINED A.Ps AND G.Ps

There will be occasions on which questions will be asked that relate to both arithmetic and geometric sequences and series.

EXAMPLE 8.21

A geometric sequence has the same first term as an arithmetic sequence.

The third term of the geometric sequence is the same as the tenth term of the arithmetic sequence with both being 48. The tenth term of the arithmetic sequence is four times the second term of the geometric sequence. Find the common difference of the arithmetic sequence and the common ratio of the geometric sequence.

Solution

When solving these sorts of question, write the data as equations, noting that a is the same for both sequences. Let u_n denote the general term of the A.P and v_n the general term of the G.P.

We then have:

$$u_{10} = a + 9d = 48, v_3 = ar^2 = 48,$$

$$\text{i.e.,} \quad a + 9d = ar^2 = 48 \quad (1)$$

$$u_{10} = 4v_2 \Rightarrow a + 9d = 4ar \quad (2)$$

(1) represents the information ‘The third term of the geometric sequence is the same as the tenth term of the arithmetic sequence with both being 48’.

(2) represents ‘The tenth term of the arithmetic sequence is four times the second term of the geometric sequence’.

There are three equations here and more than one way of solving them. One of the simplest is:

$$\text{From (1) } a + 9d = 48 \text{ and so substituting into (2): } 48 = 4ar \Leftrightarrow ar = 12 \quad (3)$$

$$\text{Also from (1) we have: } ar^2 = 48 \Leftrightarrow (ar)r = 48 \quad (4)$$

MATHEMATICS – Higher Level (Core)

Substituting (3) into (4): $12r = 48 \Leftrightarrow r = 4$

Substituting result into (1): $a \times 16 = 48 \Leftrightarrow a = 3$

Substituting result into (1): $3 + 9d = 48 \Leftrightarrow d = 5$

The common ratio is 4 and the common difference is 5.

It is worth checking that the sequences are as specified:

Geometric sequence: 3, 12, 48

Arithmetic sequence: 3, 8, 13, 18, 23, 28, 33, 38, 43, 48

EXERCISES 8.2.3

1. Consider the following sequences:
Arithmetic: 100, 110, 120, 130, . . .
Geometric: 1, 2, 4, 8, 16, . . .
Prove that:
The terms of the geometric sequence will exceed the terms of the arithmetic sequence after the 8th term.
The sum of the terms of the geometric sequence will exceed the sum of the terms of the arithmetic after the 10th term.
2. An arithmetic series has a first term of 2 and a fifth term of 30. A geometric series has a common ratio of -0.5 . The sum of the first two terms of the geometric series is the same as the second term of the arithmetic series. What is the first term of the geometric series?
3. An arithmetic series has a first term of -4 and a common difference of 1. A geometric series has a first term of 8 and a common ratio of 0.5. After how many terms does the sum of the arithmetic series exceed the sum of the geometric series?
4. The first and second terms of an arithmetic and a geometric series are the same and are equal to 12. The sum of the first two terms of the arithmetic series is four times the first term of the geometric series. Find the first term of each series. If the A.P has $d = 4$.
5. Bo-Youn and Ken are to begin a savings program. Bo-Youn saves \$1 in the first week \$2 in the second week, \$4 in the third and so on, in geometric progression. Ken saves \$10 in the first week, \$15 in the second week, \$20 in the third and so on, in arithmetic progression. After how many weeks will Bo-Youn have saved more than Ken?
6. Ari and Chai begin a training program. In the first week Chai will run 10km, in the second he will run 11km and in the third 12km, and so on, in arithmetic progression. Ari will run 5km in the first week and will increase his distance by 20% in each succeeding week.
 - (a) When does Ari's weekly distance first exceed Chai's?
 - (b) When does Ari's total distance first exceed Chai's?
7. The Fibonacci sequence: 1, 1, 2, 3, 5, 8, 13, 21, . . . in which each term is the sum of the previous two terms is neither arithmetic nor geometric. However, after the eighth term (21)

the sequence becomes approximately geometric. If we assume that the sequence is geometric:

- What is the common ratio of the sequence (to four significant figures)?
- Assuming that the Fibonacci sequence can be approximated by the geometric sequence after the eighth term, what is the approximate sum of the first 24 terms of the Fibonacci sequence?

8.2.4 CONVERGENT SERIES

If a geometric series has a common ratio between -1 and 1 , the terms get smaller and smaller as n increases.

The sum of these terms is still given by the formula: $S_n = \frac{a(1-r^n)}{1-r}$, $r \neq 1$

For $-1 < r < 1$, $r^n \rightarrow 0$ as $n \rightarrow \infty \Rightarrow S_n = \frac{a}{1-r}$.

If $|r| < 1$, the infinite sequence has a sum given by $S_\infty = \frac{a}{1-r}$.

This means that if the common ratio of a geometric series is between -1 and 1 , the sum of the series will approach a value of $\frac{a}{1-r}$ as the number of terms of the series becomes large i.e., the **series is convergent**.

EXAMPLE 8.22

Find the sum to infinity of the series

- $16 + 8 + 4 + 2 + 1 + \dots$
- $9 - 6 + 4 - \frac{8}{3} + \frac{16}{9} - \dots$

S
o
l
u
t
i
o
n

- $16 + 8 + 4 + 2 + 1 + \dots$

$$\text{In this case } a = 16, r = \frac{1}{2} \Rightarrow S_\infty = \frac{a}{1-r} = \frac{16}{1-\frac{1}{2}} = 32$$

- $9 - 6 + 4 - \frac{8}{3} + \frac{16}{9} - \dots$

$$a = 9, r = -\frac{2}{3} \Rightarrow S_\infty = \frac{a}{1-r} = \frac{9}{1-\left(-\frac{2}{3}\right)} = 5.4$$

There are a variety of applications for convergent geometric series. The following examples illustrate two of these.

EXAMPLE 8.23

Use an infinite series to express the recurring decimal $0.\dot{4}6\dot{2}$ as a rational number.

S
o
l
u
t
i
o
n

$0.\overline{462}$ can be expressed as the series: $0.462 + 0.000462 + 0.000000462 + \dots$

or $\frac{462}{1000} + \frac{462}{1000000} + \frac{462}{1000000000} + \dots$

This is a geometric series with $a = \frac{462}{1000}$, $r = \frac{1}{1000}$

It follows that $S_{\infty} = \frac{a}{1-r} = \frac{\frac{462}{1000}}{1 - \frac{1}{1000}} = \frac{\frac{462}{1000}}{\frac{999}{1000}} = \frac{462}{999}$

EXAMPLE 8.24

A ball is dropped from a height of 10 metres. On each bounce the ball bounces to three quarters of the height of the previous bounce. Find the distance travelled by the ball before it comes to rest (if it does not move sideways).

S
o
l
u
t
i
o
n

The ball bounces in a vertical line and does not move sideways. On each bounce after the drop, the ball moves both up and down and so travels twice the distance of the height of the bounce.

Distance = $10 + 15 + 15 \times \frac{3}{4} + 15 \times \left(\frac{3}{4}\right)^2 + \dots$

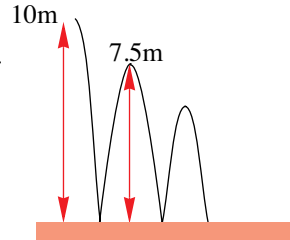

All but the first term of this series are geometric $a = 15$, $r = \frac{3}{4}$

Distance = $10 + S_{\infty} = 10 + \frac{15}{1 - \frac{3}{4}} = 70\text{m}$

EXERCISES 8.2.4

1. Evaluate:

(i) $27 + 9 + 3 + \frac{1}{3} + \dots$

(ii) $1 - \frac{3}{10} + \frac{9}{100} - \frac{27}{1000} + \dots$

(iii) $500 + 450 + 405 + 364.5 + \dots$

(iv) $3 - 0.3 + 0.03 - 0.003 + 0.0003 - \dots$

2. Use geometric series to express the recurring decimal $23.232323\dots$ as a mixed number.

3. Biologists estimate that there are 1000 trout in a lake. If none are caught, the population will increase at 10% per year. If more than 10% are caught, the population will fall. As an approximation, assume that if 25% of the fish are caught per year, the population will fall by 15% per year. Estimate the total catch before the lake is 'fished out'. If the catch rate is reduced to 15%, what is the total catch in this case? Comment on these results.

4. Find the sum to infinity of the sequence 45, -30, 20, ...
5. The second term of a geometric sequence is 12 while the sum to infinity is 64. Find the first three terms of this sequence.
6. Express the following as rational numbers
 (a) $0.3\dot{6}$ (b) $0.\dot{3}\dot{7}$ (c) $2.1\dot{2}$
7. A swinging pendulum covers 32 centimetres in its first swing, 24 cm on its second swing, 18 cm on its third swing and so on. What is the total distance this pendulum swings before coming to rest?
8. The sum to infinity of a geometric sequence is $\frac{27}{2}$ while the sum of the first three terms is 13. Find the sum of the first 5 terms.
9. Find the sum to infinity of the sequence $1 + \sqrt{3}, 1, \frac{1}{\sqrt{3} + 1}, \dots$
10. (a) Find i. $\sum_{i=0}^n (-t)^i, |t| < 1$. ii. $\sum_{i=0}^{\infty} (-t)^i, |t| < 1$.
 (b) i. Hence, show that $\ln(1+x) = x - \frac{1}{2}x^2 + \frac{1}{3}x^3 - \frac{1}{4}x^4 + \dots, |x| < 1$
 ii. Using the above result, show that $\ln 2 = 1 - \frac{1}{2} + \frac{1}{3} - \frac{1}{4} + \dots$
11. (a) Find i. $\sum_{i=0}^n (-t^2)^i, |t| < 1$. ii. $\sum_{i=0}^{\infty} (-t^2)^i, |t| < 1$.
 (b) i. Hence, show that $\arctan x = x - \frac{1}{3}x^3 + \frac{1}{5}x^5 - \frac{1}{7}x^7 + \dots, |x| < 1$
 ii. Using the above result, show that $\frac{\pi}{4} = 1 - \frac{1}{3} + \frac{1}{5} - \frac{1}{7} + \dots$

EXERCISES 8.2.5

- MISCELLANEOUS QUESTIONS

1. $2k + 2, 5k + 1$ and $10k + 2$ are three successive terms of a geometric sequence. Find the value(s) of k .
2. Evaluate $\frac{1 + 2 + 3 + \dots + 10}{1 + \frac{1}{2} + \frac{1}{4} + \dots + \frac{1}{512}}$
3. Find a number which, when added to each of 2, 6 and 13 gives three numbers in geometric sequence.

MATHEMATICS – Higher Level (Core)

- 4.** Find the fractional equivalent of
(a) $2.3\dot{8}$ (b) $4.\dot{6}\dot{2}$ (c) $0.41717\dots$
- 5.** Find the sum of all integers between 200 and 400 that are divisible by 6.
- 6.** Find the sum of the first 50 terms of an arithmetic progression given that the 15th term is 34 and the sum of the first 8 terms is 20.
- 7.** Find the value of p so that $p + 5$, $4p + 3$ and $8p - 2$ will form successive terms of an arithmetic progression.
- 8.** For the series defined by $S_n = 3n^2 - 11n$, find t_n and hence show that the sequence is arithmetic.
- 9.** How many terms of the series $6 + 3 + \frac{3}{2} + \dots$ must be taken to give a sum of $11\frac{13}{16}$?
- 10.** If $1 + 2x + 4x^2 + \dots = \frac{3}{4}$, find the value of x .
- 11.** Logs of wood are stacked in a pile so that there are 15 logs on the top row, 16 on the next row, 17 on the next and so on. If there are 246 logs in total,
(a) how many rows are there?
(b) how many logs are there in the bottom row?
- 12.** The lengths of the sides of a right angled triangle form the terms of an arithmetic sequence. If the hypotenuse is 15 cm in length, what is the length of the other two sides?
- 13.** The sum of the first 8 terms of a geometric series is 17 times the sum of its first four terms. Find the common ratio.
- 14.** Three numbers a , b and c whose sum is 15 are successive terms of a G.P, and b , a , c are successive terms of an A.P. Find a , b and c .
- 15.** The sum of the first n terms of an arithmetic series is given by $S_n = \frac{n(3n + 1)}{2}$.
(a) Calculate S_1 and S_2 .
(b) Find the first three terms of this series.
(c) Find an expression for the n th term.
- 16.** An ant walks along a straight path. After travelling 1 metre it stops, turns through an angle of 90° in an anticlockwise direction and sets off in a straight line covering a distance of half a metre. Again, the ant turns through an angle of 90° in an anticlockwise direction and sets off in a straight line covering a quarter of a metre. The ant continues in this manner indefinitely.
(a) How many turns will the ant have made after covering a distance of $\frac{63}{32}$ metres?
(b) How far will the ant 'eventually' travel?

8.3 COMPOUND INTEREST AND SUPERANNUATION

8.3.1 COMPOUND INTEREST

We have already come across some practical examples of the use of G.Ps in the area of finance. In this section we further develop these ideas and look at the area of compound interest and superannuation.

EXAMPLE 8.25

Find what \$600 amounts to in 20 years if it is invested at 8% p.a. compounding annually.

S
o
l
u
t
i
o
n

End of year 1	value	$= \$600 + 8\% \times \600 $= \$600(1.08)$
End of year 2	value	$= \$600(1.08) + 8\% \times \$600(1.08)$ $= \$600(1.08) + 0.08 \times \$600(1.08)$ $= \$600(1.08)[1 + 0.08]$ $= \$600(1.08)^2$
End of year 3	value	$= \$600(1.08)^2 + 8\% \times \$600(1.08)^2$ $= \$600(1.08)^2 + 0.08 \times \$600(1.08)^2$ $= \$600(1.08)^2[1 + 0.08]$ $= \$600(1.08)^3$
		↓
End of year 20	value	$= \$600(1.08)^{20}$

Thus, after 20 years the \$600 amounts to \$2796.57.

Looking closely at the terms of the sequence, they form a G.P:

$$600(1.08), 600(1.08)^2, 600(1.08)^3, \dots, 600(1.08)^{20}$$

where $a = 600$ and $r = 1.08$.

Developing a formula for compound interest

In general, if \$ P is invested at $r\%$ p.a. compound interest, it grows according to the sequence

$$P\left(1 + \frac{r}{100}\right), P\left(1 + \frac{r}{100}\right)^2, P\left(1 + \frac{r}{100}\right)^3, \dots, P\left(1 + \frac{r}{100}\right)^n$$

where $a = P\left(1 + \frac{r}{100}\right)$ and $r = \left(1 + \frac{r}{100}\right)$ so that

$$A_n = P\left(1 + \frac{r}{100}\right)^n \quad \text{where } A_n \text{ is the amount after } n \text{ time periods.}$$

8.3.2 SUPERANNUATION

EXAMPLE 8.26

A woman invests \$1000 at the beginning of each year in a superannuation scheme. If the interest is paid at the rate of 12% p.a. on the investment (compounding annually), how much will her investment be worth after 20 years?

S
o
l
u
t
i
o
n

- $t_1 =$ the 1st \$1000 will be invested for 20 years at 12% p.a.
- $t_2 =$ the 2nd \$1000 will be invested for 19 years at 12% p.a.
- $t_3 =$ the 3rd \$1000 will be invested for 18 years at 12% p.a.
- ⋮
- ⋮
- $t_{20} =$ the 20th \$1000 will be invested for 1 year at 12% p.a.

Finding the amount compounded annually using $A = P\left(1 + \frac{r}{100}\right)^n$, we have:

$$\begin{aligned} t_1 &= 1000\left(1 + \frac{12}{1000}\right)^{20} = 1000(1.12)^{20} \\ t_2 &= 1000\left(1 + \frac{12}{1000}\right)^{19} = 1000(1.12)^{19} \\ t_3 &= 1000\left(1 + \frac{12}{1000}\right)^{18} = 1000(1.12)^{18} \\ &\quad \vdots \\ t_{20} &= 1000\left(1 + \frac{12}{1000}\right)^1 = 1000(1.12)^1 \end{aligned}$$

To find the total of her investment after 20 years, we need to add the separate amounts:

$$\begin{aligned} \text{Total} &= 1000(1.12)^{20} + 1000(1.12)^{19} + 1000(1.12)^{18} + \dots + 1000(1.12)^1 \\ &= 1000[(1.12)^{20} + (1.12)^{19} + (1.12)^{18} + \dots + (1.12)^1] \\ &= 1000\left[\frac{1.12(1 - (1.12)^{20})}{1 - 1.12}\right] \quad \text{Using } S_n = \frac{a(1 - r^n)}{1 - r} \\ &= \$80,698.74 \end{aligned}$$

Thus her total investment amounts to \$80,698.74

EXAMPLE 8.27

Linda borrows \$2000 at 1% per month reducible interest. If she repays the loan in equal monthly instalments over 4 years, how much is each instalment?

**S
o
l
u
t
i
o
n**

Amount borrowed = \$ 2000, $r = 1\%$ per month = 0.01 and $n = 4 \times 12 = 48$ months

Let the monthly instalment be = \$ M and the amount owing after n months = \$ A_n

Our aim is to find \$ M i.e., the amount of each instalment.

After 1 month (after paying the 1st instalment), we have:

$$\begin{aligned} A_1 &= 2000 + \text{interest} - M = 2000 + 2000 \times 0.01 - M \\ &= 2000(1.01) - M \end{aligned}$$

After 2 months

$$\begin{aligned} A_2 &= A_1 \times 1.01 - M = [2000(1.01) - M] \times 1.01 - M \\ &= 2000(1.01)^2 - 1.01 \times M - M \\ &= 2000(1.01)^2 - M(1.01 + 1) \end{aligned}$$

After 3 months

$$\begin{aligned} A_3 &= A_2 \times 1.01 - M = [2000(1.01)^2 - M(1.01 + 1)] \times 1.01 - M \\ &= 2000(1.01)^3 - M(1.01 + 1) \times 1.01 - M \\ &= 2000(1.01)^3 - M[1.01^2 + 1.01 + 1] \end{aligned}$$

After 4 months

$$\begin{aligned} A_4 &= A_3 \times 1.01 - M = [2000(1.01)^3 - M(1.01^2 + 1.01 + 1)] \times 1.01 - M \\ &= 2000(1.01)^4 - M(1.01^3 + 1.01^2 + 1.01) - M \\ &= 2000(1.01)^4 - M[1.01^3 + 1.01^2 + 1.01 + 1] \end{aligned}$$

\vdots
 \vdots
 \vdots
 \vdots

After n months, we then have

$$A_n = 2000(1.01)^n - M[1 + 1.01 + 1.01^2 + 1.01^3 + \dots + 1.01^{n-1}]$$

thus, $A_{48} = 2000(1.01)^{48} - M[1 + 1.01 + 1.01^2 + 1.01^3 + \dots + 1.01^{47}]$.

Now, the loan is repaid after 48 months, meaning that $A_{48} = 0$, therefore, solving for M we have

$$\begin{aligned} 0 &= 2000(1.01)^{48} - M[1 + 1.01 + 1.01^2 + 1.01^3 + \dots + 1.01^{47}] \\ \Leftrightarrow 2000(1.01)^{48} &= M[1 + 1.01 + 1.01^2 + 1.01^3 + \dots + 1.01^{47}] \end{aligned}$$

$$\Leftrightarrow M = \frac{2000(1.01)^{48}}{[1 + 1.01 + 1.01^2 + 1.01^3 + \dots + 1.01^{47}]}$$

The denominator is a G.P with $a = 1$, $r = 1.01$ and $n = 48$, so that

$$[1 + 1.01 + 1.01^2 + 1.01^3 + \dots + 1.01^{47}] = S_{48} = \frac{1(1 - 1.01^{48})}{1 - 1.01} = 61.22261$$

Therefore, $M = \frac{2000(1.01)^{48}}{61.22261} = 52.67$

That is, each instalment must be \$52.67.

MATHEMATICS – Higher Level (Core)

The total paid = $52.67 \times 48 = 2528.16$ so that the interest paid = $2528.16 - 2000 = 528.16$
That is, she ends up paying \$ 528.16 in interest.

Although it is important that you understand the process used in the examples shown, it is also important that you can make use of technology. We now look at how the TI–83 can help us ease the pain of long calculations.

The TI–83 has a number of financial functions which enable computational ease. In particular, it has a **TVM Solver**. The **TVM Solver** displays the time-value-of-money (TVM) variables. In short, given four variable values, the **TVM Solver** solves for the fifth variable. To access the finance screen simply press

$\boxed{2\text{nd}}$ $\boxed{\text{FINANCE}}$ $\boxed{\text{ENTER}}$

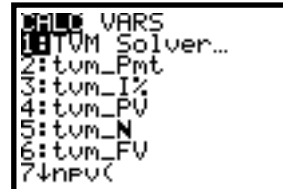

```

[2]nd [FIN] VARS
[1] TVM Solver...
2: tvn_Pmt
3: tvn_I%
4: tvn_PV
5: tvn_N
6: tvn_FV
7: npv(

```

Then, it is a matter of entering the 4 known pieces of information and then letting the **TVM Solver** do the rest.

Note: When using the TI–83 financial functions, you must enter cash inflows (cash received) as positive numbers and cash outflows (cash paid) as negative numbers.



```

N=
I%=0
PV=0
PMT=0
FV=0
P/Y=1
C/Y=1
PMT:[ ] BEGIN

```

Once you have entered your data, there are two ways in which you can then obtain the value of the unknown variable.

Method 1: Place the cursor (using the arrow keys) on the TVM variable for which you want to solve. Press $\boxed{\text{ALPHA}}$ $\boxed{\text{SOLVE}}$. The answer is computed, displayed in the **TVM Solver** screen and stored to the appropriate TVM variable.

Method 2: You need to leave this window by pressing $\boxed{2\text{nd}}$ $\boxed{\text{QUIT}}$, and return again to the finance menu, by pressing $\boxed{2\text{nd}}$ $\boxed{\text{FINANCE}}$. Select the variable you wish to solve for and then press $\boxed{\text{ENTER}}$.

We now illustrate this process using the previous example. In this example we have the known quantities:

Linda borrowed \$2000, $\therefore PV = -2000$

$I\% = 1$ and $N (= 4 \times 12) = 48$

$FV = 0$ (i.e., loan is fully repaid)

$PMT = ?$ (the monthly repayment required)

That is, once we have entered the information, we then make use of method 1 while at the TVM Solver screen:



```

N=48
I%=1
PV=-2000
PMT=
FV=0
P/Y=1
C/Y=1
PMT:[ ] BEGIN

```

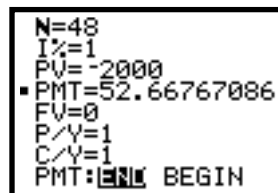

```

N=48
I%=1
PV=-2000
PMT=52.66767086
FV=0
P/Y=1
C/Y=1
PMT:[ ] BEGIN

```

Notice that in the second screen there is a square next to the PMT variable. This is to indicate which variable has just been calculated.

EXERCISES 8.3

1. To how much will \$1000 grow to if it is invested at 12% p.a. for 9 years, compounding annually?
2. A bank advertises an annual interest rate of 13.5% p.a. but adds interest to the account monthly, giving a monthly interest rate of 1.125%. Scott deposits \$3500 with the bank. How much will he withdraw in 20 months time?
3. To what amount will \$900 grow to if it is invested at 10% p.a. for 7 years, compounding every 6 months?
4. A man borrows \$5000 at 18% p.a. over a period of 5 years, with the interest compounding every month. Find to the nearest dollar the amount owing after 5 years.
5. Find the total amount required to pay off a loan of \$20,000 plus interest at the end of 5 years if the interest is compounded half yearly and the rate is 12%.
6. A man invests \$500 at the beginning of each year in a superannuation fund. If the interest is paid at the rate of 12% p.a. on the investment (compounding annually), how much will his investment be worth after 20 years?
7. A woman invests \$2000 at the beginning of each year into a superannuation fund for a period of 15 years at a rate of 9% p.a. (compounding annually). Find how much her investment is worth at the end of the 15 years.
8. A man deposits \$3 000 annually to accumulate at 9% p.a. compound interest. How much will he have to his credit at the end of 25 years? Compare this to depositing \$750 every three months for the same length of time and at the same rate. Which of these two options gives the better return?
9. A woman invests \$200 at the beginning of each month into a superannuation scheme for a period of 15 years. Interest is paid at the rate of 7% p.a. and is compounded monthly. How much will her investment be worth at the end of the 15 year period?
10. Peter borrows \$5000 at 1.5% per month reducible interest. If he repays the loan in equal monthly instalments over 8 years, how much is each instalment, and what is the total interest charged on the loan? Compare this to taking the same loan, but at a rate of 15% p.a. flat rate.
11. Kevin borrows \$7500 to be paid back at 12.5% p.a. monthly reducible over a period of 7 years. What is the amount of each monthly instalment and what is the total interest charged on the loan. Find the equivalent flat rate of interest.

9.1 TRIGONOMETRIC RATIOS

9.1.1 REVIEW OF TRIGONOMETRIC FUNCTIONS FOR RIGHT-ANGLED TRIANGLES

The trigonometric functions are defined as **ratio functions** in a right-angled triangle. As such they are often referred to as the **trigonometric ratios**.

The trigonometric ratios are based on the right-angled triangle shown alongside. Such right-angled triangles are defined in reference to a nominated angle. In the right-angled triangle ABC the longest side [AB] (opposite the right-angle) is the **hypotenuse**. Relative to the angle $\angle BAC$ of size θ° , the side BC is called the **opposite** side while the side AC is called the **adjacent** side.

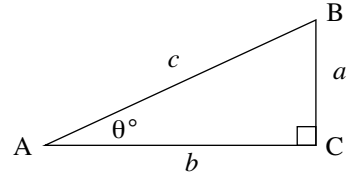

The trigonometric ratios are defined as

$$\sin \theta^\circ = \frac{\text{opposite}}{\text{hypotenuse}} = \frac{a}{c}, \quad \cos \theta^\circ = \frac{\text{adjacent}}{\text{hypotenuse}} = \frac{b}{c}, \quad \tan \theta^\circ = \frac{\text{opposite}}{\text{adjacent}} = \frac{a}{b}$$

Note then, that $\tan \theta^\circ = \frac{\sin \theta^\circ}{\cos \theta^\circ}$, $\cos \theta \neq 0$.

There also exists another important relation between the side lengths of a right-angled triangle.

This relationship, using **Pythagoras's Theorem** is $a^2 + b^2 = c^2$

Do not forget to adjust the mode of your calculator to degree mode when necessary. On the TI-83, this is done by pressing **MODE** and then selecting the **Degree** mode. As angles can be quoted in degrees '°', minutes '' and seconds "" we make use of the **DMS** option under the **ANGLE** menu (accessed by pressing **2nd APPS**) to convert an angle quoted as a decimal into one quoted in degrees, minutes and seconds.

9.1.2 EXACT VALUES

There are a number of special right-angled triangles for which exact values of the trigonometric ratios exist. Two such triangles are shown below:



From these triangles we can tabulate the trigonometric ratios as follows:

θ	$\sin \theta^\circ$	$\cos \theta^\circ$	$\tan \theta^\circ$
30	$\frac{1}{2}$	$\frac{\sqrt{3}}{2}$	$\frac{1}{\sqrt{3}}$
45	$\frac{1}{\sqrt{2}}$	$\frac{1}{\sqrt{2}}$	1
60	$\frac{\sqrt{3}}{2}$	$\frac{1}{2}$	$\sqrt{3}$

EXAMPLE 9.1

Find x in each of the following triangles (correct to 4 d.p)

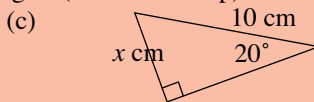
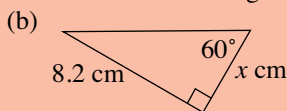
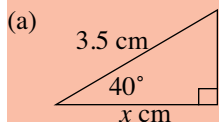

Solution

(a) We label the sides relative to the given angle:

As the sides involved are the adjacent (adj) and the hypotenuse (hyp). The appropriate ratio is the cosine ratio, i.e., $\cos \theta = \frac{\text{adj}}{\text{hyp}}$. Then, substituting the information into the expression we can solve for x :

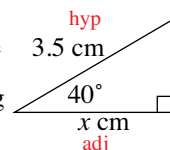

$$\cos 40^\circ = \frac{x}{3.5} \Leftrightarrow 3.5 \times \cos 40^\circ = x$$

$$\therefore x = 2.6812 \text{ (to 4 d.p)}$$

A quick word about using the TI-83. Below we show that depending on the mode setting we obtain different values. In particular, note that in Case B, even though the mode setting was in radians, we were able to over ride this by using the degree measure, '°', under the ANGLE menu.

Case A:

Case B:

Case C:

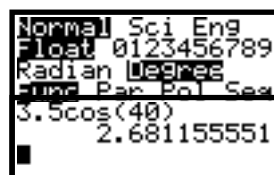
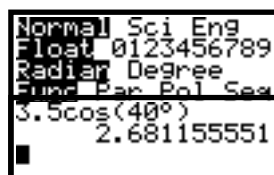
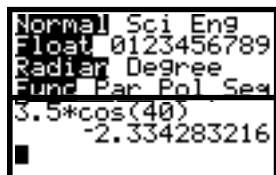

(b) We label the sides relative to the given angle.

The sides involved are the adjacent (adj) and the opposite (opp) the appropriate ratio is the tangent ratio, i.e., $\tan \theta = \frac{\text{opp}}{\text{adj}}$. Then, substituting the information into the expression we can solve for x :

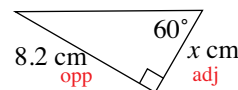

$$\tan 60^\circ = \frac{8.2}{x} \Leftrightarrow x \tan 60^\circ = 8.2 \Leftrightarrow x = \frac{8.2}{\tan 60^\circ}$$

$$\therefore x = 4.7343 \text{ (to 4 d.p)}$$

(c) We label the sides relative to the given angle.

The sides involved are the opposite (opp) and the hypotenuse (hyp).

The appropriate ratio is the sine ratio, i.e., $\sin \theta = \frac{\text{opp}}{\text{hyp}}$. Then,

substituting the information into the expression we can solve for x :

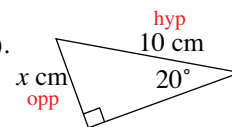

$$\sin 20^\circ = \frac{x}{10} \Leftrightarrow 10 \times \sin 20^\circ = x$$

$$\therefore x = 3.4202 \text{ (to 4 d.p.)}$$

EXAMPLE 9.2

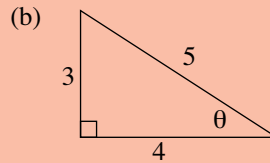
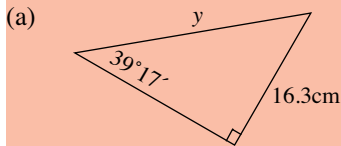
 Find x and θ in the following triangles

Solution

(a) The important sides are the opposite and hypotenuse. So,

$$\sin 39^\circ 17' = \frac{16.3}{y} \Leftrightarrow y \times \sin 39^\circ 17' = 16.3$$

$$\Leftrightarrow y = \frac{16.3}{\sin 39^\circ 17'}$$

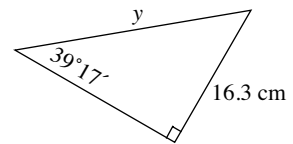
$$\therefore y = 25.7 \text{ cm}$$



The TI-82/83 calculators accept angle inputs using the **2nd ANGLE** menu. **Option 1** allows entry of angles in degrees irrespective of the **MODE** setting of the calculator. **Option 2** allows the entry of degrees, minutes, seconds.

The problem would be solved using the keying sequence

16.3 ÷ sin 39 **2nd ANGLE 1** 17 **2nd ANGLE 2** ENTER.

(b) When using a calculator to find an angle, **option 4** of the **2nd ANGLE** menu will allow you to display an answer in degree, minute, second format.

Any of the three trigonometric ratios will do, but when finding angles, it is generally best to use the cosine ratio. The reason for this should become apparent as this chapter progresses.

$$\cos \theta = \frac{4}{5} \Rightarrow \theta = \cos^{-1}\left(\frac{4}{5}\right) \therefore \theta \approx 36^\circ 52' 12''$$

rounded to the nearest second.

EXAMPLE 9.3

Using the triangle shown, find

- (a) i. AB
 ii. $\cos \alpha$
 iii. $\tan \alpha$
- (b) If $\cos \alpha = 0.2$ find $\sin(90^\circ - \alpha)$.

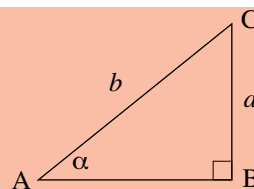

S
o
l
u
t
i
o
n

- (a) Using Pythagoras's Theorem we have $AC^2 = AB^2 + BC^2 \therefore b^2 = AB^2 + a^2$
 $\Leftrightarrow AB^2 = b^2 - a^2$
 $\Rightarrow AB = \sqrt{b^2 - a^2}$
- (b) $\cos \alpha = \frac{AB}{AC} = \frac{\sqrt{b^2 - a^2}}{b}$
- (c) $\tan \alpha = \frac{CB}{AB} = \frac{a}{\sqrt{b^2 - a^2}}$
- (d) $\sin(90^\circ - \alpha) = \frac{AB}{AC}$, but $\cos \alpha = \frac{AB}{AC} \therefore \sin(90^\circ - \alpha) = \cos \alpha$.
 i.e., $\sin(90^\circ - \alpha) = 0.2$

Often we are dealing with non right-angled triangles. However, these can be 'broken up' into at least two right-angled triangles, which then involves solving simultaneous equations. This is illustrated in the next example.

EXAMPLE 9.4

Find the angle θ in the diagram shown.

Note that $\angle ACB \neq 90^\circ$.

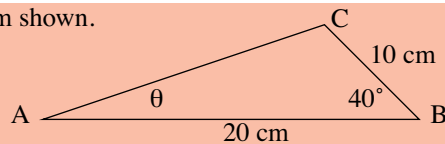

S
o
l
u
t
i
o
n

We start by 'breaking-up' the triangle into two right-angled triangles as follows:

Using $\triangle ACP$:

$$\tan \theta = \frac{PC}{AP} = \frac{y}{20 - x} \quad (1)$$

We now need to determine x and y .

Using $\triangle BPC$:

$$\sin 40^\circ = \frac{PC}{BC} = \frac{y}{10}$$

$$\Leftrightarrow y = 10 \sin 40^\circ \quad (2)$$

and $\cos 40^\circ = \frac{BP}{BC} = \frac{x}{10}$

$$\Leftrightarrow x = 10 \cos 40^\circ \quad (3)$$

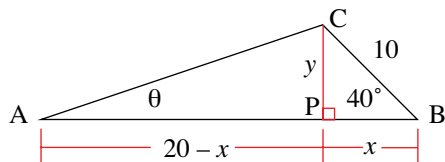

Therefore, substituting (3) and (2) into (1) we have:

$$\tan \theta = \frac{10 \sin 40^\circ}{20 - 10 \cos 40^\circ}$$

$$= 0.5209$$

$$\therefore \theta = \tan^{-1}(0.5209)$$

$$= 27.5157$$

$$= 27^\circ 31'$$

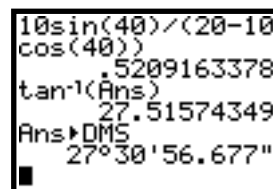

Note that we have not rounded down our answer until the very last step.

EXERCISES 9.1

1. The parts of this question refer to the triangle shown. Complete the blank spaces in this table, giving lengths correct to three significant figures and angles correct to the nearest degree.

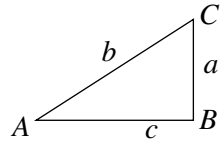

	<i>a</i> cm	<i>b</i> cm	<i>c</i> cm	<i>A</i>	<i>B</i>	<i>C</i>
1.			1.6		90°	23°
2.		98.3			90°	34°
3.			33.9		90°	46°
4.		30.7			90°	87°
5.	2.3				90°	33°
6.		77			90°	51°
7.	44.4		68.4		90°	57°
8.			12.7	13°	90°	
9.		94.4		52°	90°	

	<i>a</i> cm	<i>b</i> cm	<i>c</i> cm	<i>A</i>	<i>B</i>	<i>C</i>
10.	71.8		64.6	48°	90°	
11.		34.1		43°	90°	
12.			2.3	87°	90°	
13.	71.5			63°	90°	
14.	33.5		6.5		90°	
15.	6.1	7.2			90°	
16.		30	7.3		90°	
17.	29.0		2.0		90°	
18.	34.5	88.2			90°	
19.	24.0	29.7			90°	
20.		46.2			90°	27°
21.	59.6	41.8			90°	35°
22.		6.8			90°	37°
23.			14.9	41°	90°	49°
24.			16.1	41°	90°	49°
25.			33.3	68°	90°	22°

2. Find the exact value of *x* in each of the following

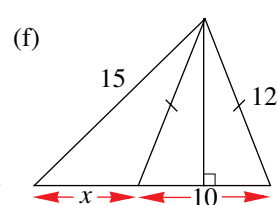
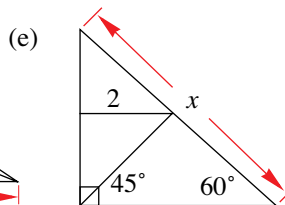
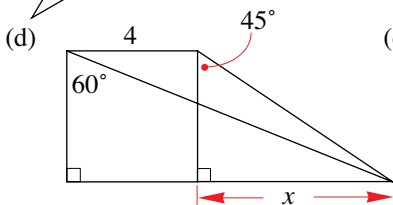
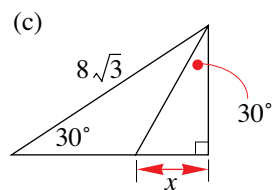
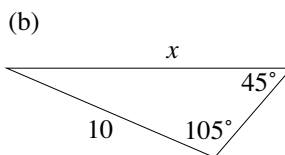
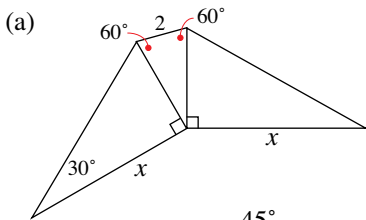

MATHEMATICS – Higher Level (Core)

3. Using the triangle on the right, show that

(a) $\sin(90^\circ - \theta) = \cos \theta$

(b) $\cos(90^\circ - \theta) = \sin \theta$

(c) $\tan(90^\circ - \theta) = \frac{1}{\tan \theta}$

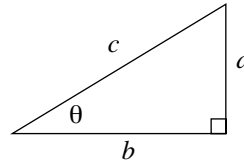

4. Find the exact value of x in each of the following.

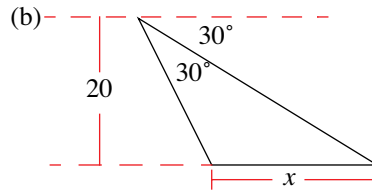
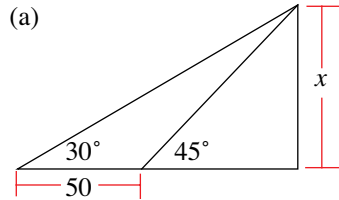

5. Show that $OZ = \frac{x \tan \theta (\sin \alpha + \cos \alpha \tan \beta)}{\tan \theta - \tan \beta}$

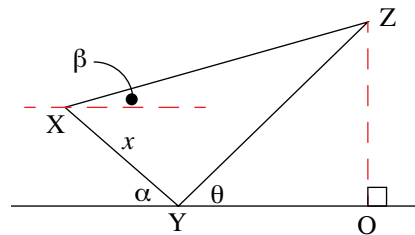

9.2 APPLICATIONS

Applications that require the use of trigonometric ratios and right-angled triangles are many and varied. In this section we consider a number of standard applications to highlight this.

9.2.1 ANGLE OF ELEVATION AND DEPRESSION

The **angle of elevation** is the angle of the line of sight **above** the horizontal of an object seen above the horizontal

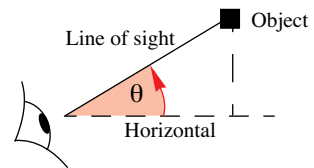

The **angle of depression** is the angle of the line of sight **below** the horizontal of an object seen below the horizontal

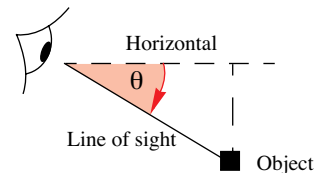

Note that the angle of depression and elevation for the same line of sight are **alternate angles**.

EXAMPLE 9.5

An observer standing on the edge of a cliff 82 m above sea level sees a ship at an angle of depression of 26° . How far from the base of the cliff is the ship situated?

S
o
l
u
t
i
o
n

We first draw a diagram to represent this situation:
Let the ship be at point S, x metres from the base of the cliff, B, and let O be where the observer is standing.

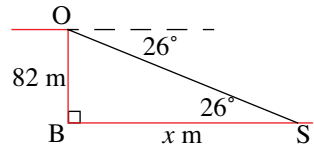

Using the right-angled triangle OBS we have:

$$\tan 26^\circ = \frac{82}{x} \Leftrightarrow x \tan 26^\circ = 82$$

$$\Leftrightarrow x = \frac{82}{\tan 26^\circ} = 168.1249\dots$$

Therefore, the ship is 168 m from the base of the cliff.

E **EXAMPLE 9.6**

The angle of depression from the roof of building A to the foot of a second building, B, across the same street and 40 metres away is 65° . The angle of elevation of the roof of building B to the roof of building A is 35° . How tall is building B?

S
o
l
u
t
i
o
n

Let the height of building B be x m and that of building A be y m.

Note that we are using the fact that for the same line of sight, the angle of depression and elevation is equal.

The height difference between the two buildings must then be $(y - x)$ m.

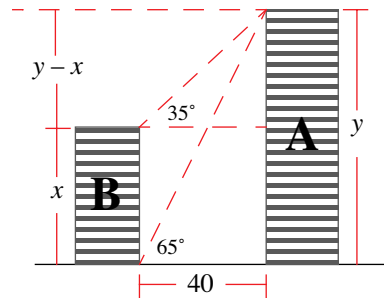

We now have two right-angled triangles to work with:

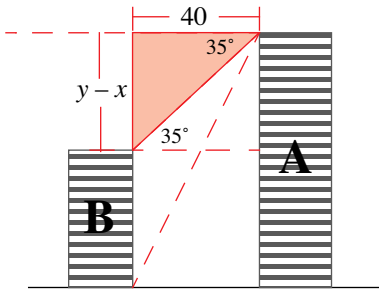

$$\tan 35^\circ = \frac{y-x}{40}$$

$$\Leftrightarrow y - x = 40 \tan 35^\circ \quad (1)$$

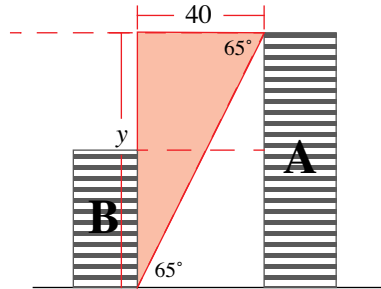

$$\tan 65^\circ = \frac{y}{40}$$

$$\Leftrightarrow y = 40 \tan 65^\circ \quad (2)$$

Substituting (2) into (1) we have:

$$40 \tan 65^\circ - x = 40 \tan 35^\circ$$

$$\Leftrightarrow x = 40 \tan 65^\circ - 40 \tan 35^\circ$$

$$\therefore x = 57.7719\dots$$

That is, building B is 57.77 m

9.2.2 BEARINGS

In the sport of orienteering, participants need to be skilled in handling bearings and reading a compass. Bearings can be quoted by making reference to the North, South, East and West directions or using true bearings. We look at each of these.

Compass bearings

These are quoted in terms of an angle measured East, West, North or South, or somewhere in between. For example, North 30° East, expressed as N30°E, informs us that from the North direction we rotate 30° towards the East and then follow that line of direction. The following diagrams display this for a number of bearings.

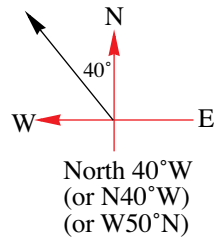
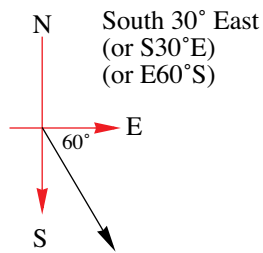
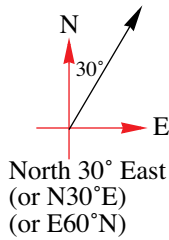

True bearings

These are quoted in terms of an angle measured in a clockwise direction from North (and sometimes a capital T is attached to the angle to highlight this fact). So, for example, a bearing of 030°T would represent a bearing of 30° in a clockwise direction from the North – this corresponds to a compass bearing of N30°E. Using the above compass bearings we quote the equivalent true bearings:

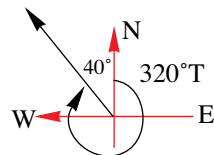
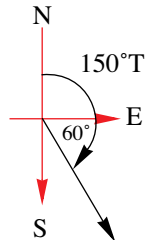
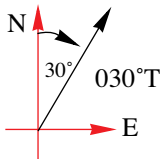

EXAMPLE 9.7

Janette walks for 8 km North-East and then 11 km South-East. Find the distance and bearing from her starting point.

Solution

First step is to draw a diagram.

As $\angle OAB = 90^\circ$ we can make use of Pythagoras's

Theorem:

$$x^2 = 8^2 + 11^2$$

$$\therefore x = 13.60 \text{ [taking +ve square root]}$$

$$\text{Let } \theta = \angle AOB \text{ so that } \tan \theta = \frac{11}{8} \therefore \theta = \tan^{-1}\left(\frac{11}{8}\right)$$

$$= 53.97^\circ$$

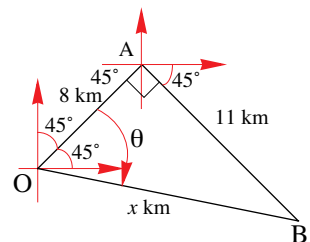

Therefore, bearing is $45^\circ + \theta = 45^\circ + 53.97^\circ = 98.97^\circ$

That is, B has a bearing of 98.97°T from O and is (approx) 13.6 km away.

EXAMPLE 9.8

The lookout, on a ship sailing due East, observes a light on a bearing of 056°T . After the ship has travelled 4.5 km, the lookout now observes the light to be on a bearing of 022°T . How far is the light source from the ship at its second sighting?

S
o
l
u
t
i
o
n

As always, we start with a diagram.

Using $\triangle OBC$ we have, $\tan 34^\circ = \frac{BC}{OB} = \frac{a}{4.5 + c}$
 $\therefore a = (4.5 + c) \tan 34^\circ$ — (1)

Using $\triangle ABC$ we have, $\tan 68^\circ = \frac{BC}{AB} = \frac{a}{c}$
 $\therefore a = c \tan 68^\circ$ — (2)

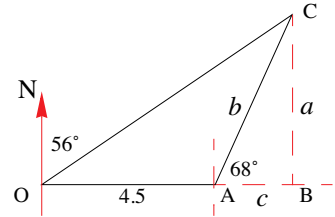

Equating (1) and (2) we have, $c \tan 68^\circ = (4.5 + c) \tan 34^\circ$

$$c \tan 68^\circ = 4.5 \tan 34^\circ + c \tan 34^\circ$$

$$\Leftrightarrow c(\tan 68^\circ - \tan 34^\circ) = 4.5 \tan 34^\circ$$

$$\Leftrightarrow c = \frac{4.5 \tan 34^\circ}{(\tan 68^\circ - \tan 34^\circ)}$$

$$\therefore c = 1.6857$$

Substituting this result into (2) we have,

$$a = \frac{4.5 \tan 34^\circ}{(\tan 68^\circ - \tan 34^\circ)} \times \tan 68^\circ$$

$$\therefore a = 4.1723$$

Then, using $\triangle ABC$ and Pythagoras's Theorem, we have

$$b^2 = a^2 + c^2$$

$$= 4.1723^2 + 1.6857^2$$

$$\therefore b = \sqrt{20.2496}$$

$$= 4.4999$$

That is, the light is 4.5 km from the ship (at the second sighting).
 Can you see a much quicker solution? Hint – think isosceles triangle.

```
(4.5tan(34))/(tan(68)-tan(34))
1.68572967
```

```
(4.5tan(34))/(tan(68)-tan(34))
1.68572967
Ans*tan(68)
4.172327346
```

```
4.1723^2+1.6857^2
20.24967178
√(Ans)
4.499963531
```

EXERCISES 9.2

1. (a) Change the following compass bearings into true bearings
 - i. $N30^\circ\text{E}$ ii. $N30^\circ\text{W}$ iii. $S15^\circ\text{W}$ iv. $W70^\circ\text{S}$
 (b) Change the following true bearings into compass bearings
 - i. 025°T ii. 180°T iii. 220°T iv. 350°T
2. The angle of depression from the top of a building 60 m high to a swing in the local playground is 58° . How far is the swing from the foot of the building?
3. From a point A on the ground, the angle of elevation to the top of a tree is 52° . If the tree is 14.8 m away from point A, find the height of the tree.

MATHEMATICS – Higher Level (Core)

4. Find the angle of elevation from a bench to the top of an 80 m high building if the bench is 105 m from the foot of the building.
5. Patrick runs in a direction $N60^{\circ}E$ and after 45 minutes finds himself 3900 m North of his starting point. What is Patrick's average speed in ms^{-1} .
6. A ship leaves Oldport and heads NW. After covering a distance of 16 km it heads in a direction of $N68^{\circ}22'W$ travelling a distance of 22 km where it drops anchor. Find the ship's distance and bearing from Oldport after dropping anchor.
7. From two positions 400 m apart on a straight road, running in a northerly direction, the bearings of a tree are $N36^{\circ}40'E$ and $E33^{\circ}22'S$. What is the shortest distance from the tree to the road?
8. A lamp post leaning away from the sun and at 6° from the vertical, casts a shadow 12 m long when the sun's angle of elevation is 44° . Assuming that the level of the ground where the pole is situated is horizontal, find its length.
9. From a window, 29.6 m above the ground, the angle of elevation of the top of a building is 42° , while the angle of depression to the foot of the building is 32° . Find the height of the building.
10. Two towns P and Q are 50 km apart, with P due west of Q. The bearing of a station from town P is $040^{\circ}T$ while the bearing of the station from town Q is $300^{\circ}T$. How far is the station from town P?
11. When the sun is 74° above the horizon, a vertical flagpole casts a shadow 8.5 m onto a horizontal ground. Find the shadow cast by the sun when it falls to 62° above the horizontal.
12. A hiker walks for 5km on a bearing of 053° true (North 53° East). She then turns and walks for another 3km on a bearing of 107° true (East 17° South).
 - (a) Find the distance that the hiker travels North/South and the distance that she travels East/West on the first part of her hike.
 - (b) Find the distance that the hiker travels North/South and the distance that she travels East/West on the second part of her hike.
 - (c) Hence find the total distance that the hiker travels North/South and the distance that she travels East/West on her hike.
 - (d) If the hiker intends to return directly to the point at which she started her hike, on what bearing should she walk and how far will she have to walk?
13. A surveying team are trying to find the height of a hill. They take a 'sight' on the top of the hill and find that the angle of elevation is $23^{\circ}27'$. They move a distance of 250 metres on level ground directly away from the hill and take a second 'sight'. From this point, the angle of elevation is $19^{\circ}46'$. Find the height of the hill, correct to the nearest metre.

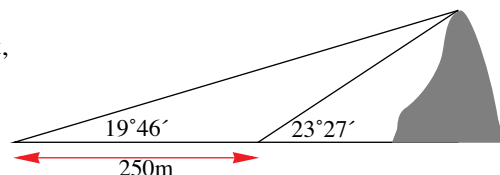

9.3 RIGHT ANGLES IN 3-DIMENSIONS

When dealing with problems in three dimensions, we draw the figures in perspective, so that a model can be more accurately visualised. This does not mean that you must be an artist, simply that you take a little time (and a lot of practice) when drawing such diagrams. The key to many 3-D problems is locating the relevant right-angled triangles within the diagram. Once this is done, all of the trigonometric work that has been covered in the previous two sections can be applied. As such, we will not be learning new theory, but rather developing new drawing and modelling skills. Some typical examples of solids that may be encountered are:

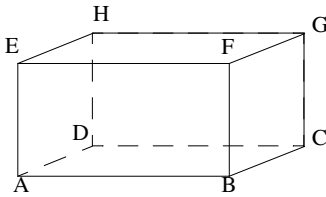

Cuboid ABCD, EFGH

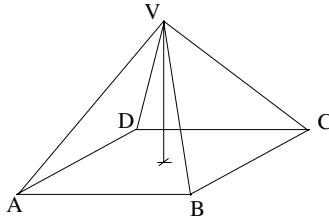

Right Pyramid V, ABCD

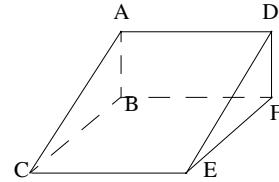

Wedge ABC, DEF

We look at two basic concepts and drawing techniques to help us.

1. A line and a plane:

A line will always cut a plane at some point (unless the line is parallel to the plane). To find the angle between a line and a plane construct a perpendicular from the line to the plane and complete a right-angled triangle. In our diagram, we have that the segment $[AB]$ is projected onto the plane. A perpendicular, $[BC]$ is drawn, so that a right-angled triangle, ABC is completed. The angle that the line then makes with the plane is given by θ (which can be found by using the trig-ratios).

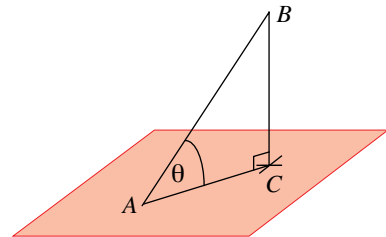

2. A plane and a plane:

To find the angle between two planes $ABCD$ and $ABEF$ (assuming that they intersect), take any point P on the intersecting segment $[AB]$ and draw $[PQ]$ and $[PR]$ on each plane in such a way that they are perpendicular to $[AB]$. Then, the angle between $[PQ]$ and $[PR]$ (θ) is the angle between the two planes.

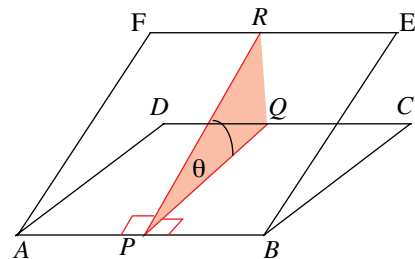

EXAMPLE 9.9

A cube ABCD, EFGH has a side length measuring 6 cm.

- Find the length of the segment $[AC]$.
- The length of the diagonal $[AG]$.
- The angle that the diagonal $[AG]$ makes with the base.

S
o
l
u
t
i
o
n

First we need to draw a cube:

- (a) Now the base of the cube is a square, so that $\angle ABC = 90^\circ$, i.e., we have a right-angled triangle, so we can use Pythagoras's Theorem:
- $$AC^2 = AB^2 + BC^2$$
- $$= 6^2 + 6^2$$
- $$= 72$$
- $$\therefore AC = \sqrt{72} \approx 8.49$$

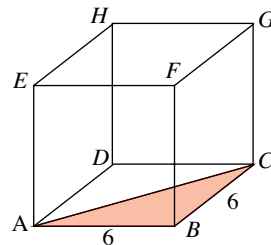

- (b) This time we have that $\angle ACG = 90^\circ$, therefore,
- $$AG^2 = AC^2 + CG^2$$
- $$= (\sqrt{72})^2 + 6^2$$
- $$= 108$$
- $$\therefore AC = \sqrt{108} \approx 10.39$$

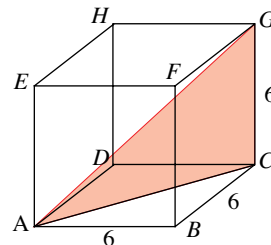

- (c) Using triangle ACG, $\tan \theta = \frac{CG}{AC} \therefore \tan \theta = \frac{6}{\sqrt{72}}$
- $$\theta = \tan^{-1}\left(\frac{6}{\sqrt{72}}\right)$$
- $$= 35.26^\circ$$
- $$= 35^\circ 16'$$

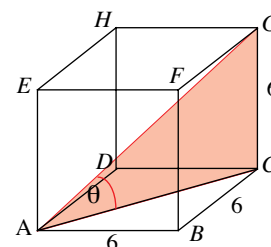

EXAMPLE 9.10

From a point X, 200 m due South of a cliff, the angle of elevation of the top of the cliff is 30° . From a point Y, due East of the cliff, the angle of elevation of the top of the cliff is 20° . How far apart are the points X and Y?

S
o
l
u
t
i
o
n

We start by illustrating this information on a 3-D diagram (Note that North–South and West–East are drawn on a plane. It is necessary to do this otherwise the diagram will not make sense).

Let the cliff be h metres high. The distance from X to the base of the cliff be x metres and the distance from Y to the base of the cliff be y metres.

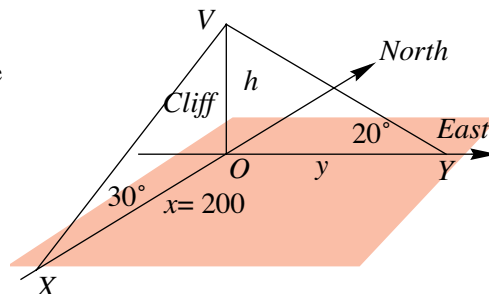

As $\angle XOY = 90^\circ$, then $XY^2 = x^2 + y^2$

$$= 200^2 + y^2$$

But, $\tan 20^\circ = \frac{h}{y}$, of which we know neither h or y .

However, using triangle XOY, we have that $\tan 30^\circ = \frac{h}{200} \Rightarrow h = 200 \times \tan 30^\circ$.

Therefore, we have that $\tan 20^\circ = \frac{200 \times \tan 30^\circ}{y} \Leftrightarrow y = \frac{200 \times \tan 30^\circ}{\tan 20^\circ}$

That is, $y = 317.25$

Therefore, $XY^2 = x^2 + y^2 = 200^2 + \left(\frac{200 \times \tan 30^\circ}{\tan 20^\circ}\right)^2$
 $= 140648.4289$
 $XY = 375.0312$.

That is, X and Y are approximately 375 m apart.

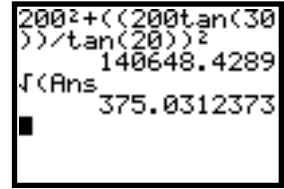

EXERCISES 9.3

- For the diagram shown, determine the angle of inclination between the plane
 - ABCD and the base, EABH (Figure 1).
 - ABC and the base EBFA (Figure 2).

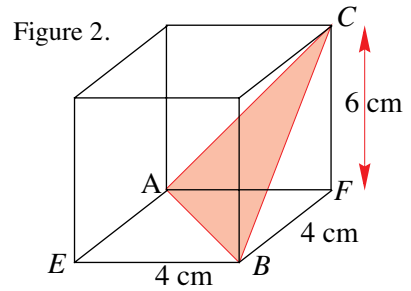
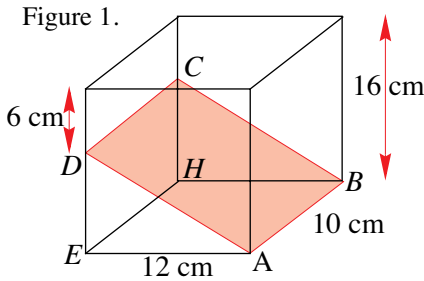

- A right pyramid with a rectangular base and a vertical height of 60 cm is shown in the diagram alongside. The points X and Y are the midpoints of the sides [AB] and [BC] respectively. Find
 - the length, AP.
 - the length of the edge [AV].
 - the angle that the edge AV makes with the base ABCD.
 - the length, YV.
 - The angle that the plane BCV makes with the base.

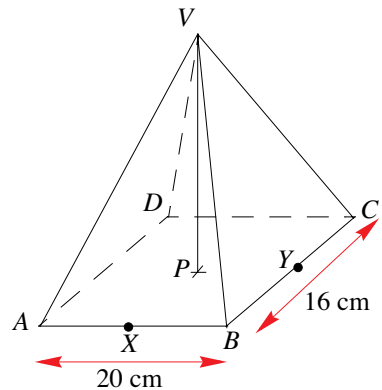

- The diagram alongside shows a rectangular box with side lengths AB = 8 cm, BC = 6 cm and CG = 4 cm. Find the angle between
 - the line [BH] and the plane ABCD.
 - the lines [BH] and [BA].
 - the planes ADGF and ABCD.

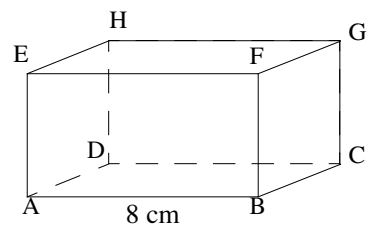

MATHEMATICS – Higher Level (Core)

- 4.** For the wedge shown alongside, given that the angle between the lines EA and ED is 50° find
- the length of [AE].
 - the $\angle AEB$.

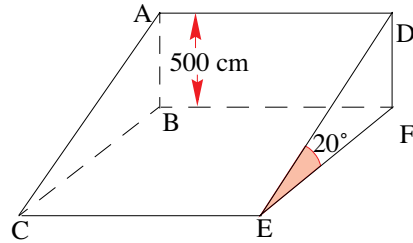

- 5.** From a point A, 100 m due South of a tower, the angle of elevation of the top of the tower is 40° . From a point B, due East of the tower, the angle of elevation of the top of the tower is 20° . How far apart are the points A and B?
- 6.** For the triangular prism shown alongside find

- the value of h
- the value of α
- the angle that the plane ABV makes with the base ABC.

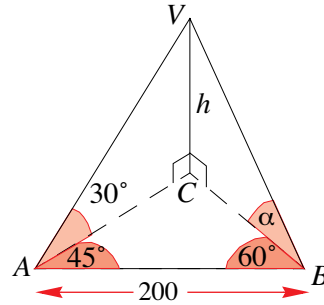

- 7.** The angle of depression from the top of a tower to a point X South of the tower, on the ground and 120 m from the foot of the tower is 24° . From point Y due West of X the angle of elevation to the top of the tower is 19° .
- Illustrate this information on a diagram.
 - Find the height of the tower.
 - How far is Y from the foot of the tower?
 - How far apart are the points X and Y?

- 8.** A mast is held in a vertical position by four ropes of length 60 metres. All four ropes are attached at the same point at the top of the mast so that their other ends form the vertices of a square when pegged into the (level) ground. Each piece of rope makes an angle of 54° with the ground.
- Illustrate this information on a diagram.
 - How tall is the mast?

- 9.** A symmetrical sloping roof has dimensions as shown in the diagram. Find

- the length of [FM].
- the angle between the plane BCEF and the ground.
- the angle between the plane ABF and the ground
- the total surface area of the roof.

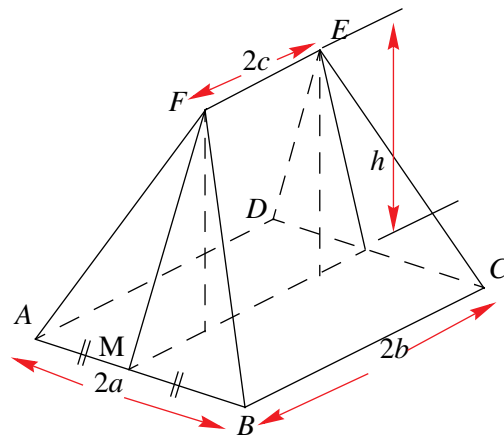

- 10.** The angle of elevation of the top of a tower from a point A due South of it is 68° . From a point B, due East of A, the angle of elevation of the top is 54° . If A is 50 m from B, find the height of the tower.
- 11.** A tower has been constructed on the bank of a long straight river. From a bench on the opposite bank and 50 m downstream from the tower, the angle of elevation of the top of the tower is 30° . From a second bench on the same side of the tower and 100 m upstream from the tower, the angle of elevation of the top of the tower is 20° . Find
- the height of the tower.
 - the width of the river.
- 12.** A right pyramid of height 10 m stands on a square base of side lengths 5 m. Find
- the length of the slant edge.
 - the angle between a sloping face and the base.
 - the angle between two sloping faces.
- 13.** A camera sits on a tripod with legs 1.5 m long. The feet rest on a horizontal flat surface and form an equilateral triangle of side lengths 0.75 m. Find
- the height of the camera above the ground.
 - the angles made by the legs with the ground.
 - the angle between the sloping faces formed by the tripod legs.
- 14.** From a point A due South of a mountain, the angle of elevation of the mountaintop is α . When viewed from a point B, x m due East of A, the angle of elevation of the mountaintop is β . Show that the height, h m, of the mountain is given by $h = \frac{x \sin \alpha \sin \beta}{\sqrt{\sin^2 \alpha - \sin^2 \beta}}$.

9.4 AREA OF A TRIANGLE

Given **any** triangle with sides a and b , and the included angle θ , the area, A , is given by

$$A = \frac{1}{2}bh$$

However, $\sin \theta = \frac{h}{a} \Leftrightarrow h = a \times \sin \theta$ and so, we have that

$$A = \frac{1}{2}b \times a \times \sin \theta$$

where θ is the angle between sides a and b .

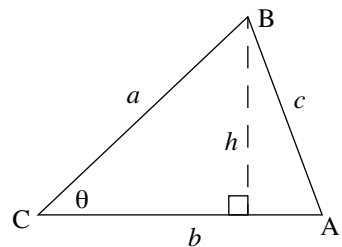

Note that the triangle need not be a right-angled triangle.

Because of the standard labelling system for triangles, the term

$\sin \theta$ is often replaced by $\sin C$, given the expression $\text{Area} = \frac{1}{2}ab \sin C$.

A similar argument can be used to generate the formulas: $\text{Area} = \frac{1}{2}bc \sin A = \frac{1}{2}ac \sin B$

EXAMPLE 9.11

Find the area of the triangle PQR given that PQ = 9 cm, QR = 10 cm and $\angle PQR = 40^\circ$.

S
o
l
u
t
i
o
n

Based on the given information we can construct the following triangle:

Meaning that, the required area, A, is given by

$$A = \frac{1}{2}ab \sin \theta = \frac{1}{2} \times 9 \times 10 \times \sin 40^\circ$$

$$= 28.9$$

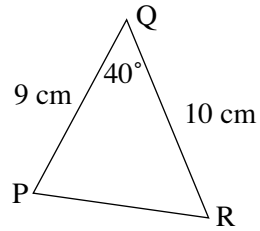

That is, the area is 28.9 cm^2 .

EXAMPLE 9.12

The diagram shows a triangular children's playground.

Find the area of the playground

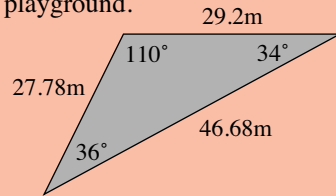

S
o
l
u
t
i
o
n

Since all the measurements of the triangle are known, any one of the three formulas could be used. Many people remember the formula as 'Area equals half the product of the lengths of two sides times the sine of the angle between them'.

$$\text{Area} = \frac{1}{2} \times 27.78 \times 46.68 \times \sin 36^\circ = 381 \text{ m}^2$$

$$\text{Area} = \frac{1}{2} \times 27.78 \times 29.2 \times \sin 110^\circ = 381 \text{ m}^2$$

$$\text{Area} = \frac{1}{2} \times 29.2 \times 46.68 \times \sin 34^\circ = 381 \text{ m}^2$$

EXERCISES 9.4

1. Find the areas of these triangles that are labelled using standard notation.

	<i>a</i> cm	<i>b</i> cm	<i>c</i> cm	<i>A</i>	<i>B</i>	<i>C</i>
(a)	35.94	128.46	149.70	12°	48°	120°
(b)	35.21	54.55	81.12	20°	32°	128°
(c)	46.35	170.71	186.68	14°	63°	103°
(d)	33.91	159.53	163.10	12°	78°	90°
(e)	42.98	25.07	48.61	62°	31°	87°
(f)	39.88	24.69	34.01	84°	38°	58°
(g)	43.30	30.26	64.94	34°	23°	123°
(h)	12.44	2.33	13.12	68°	10°	102°

	<i>a</i> cm	<i>b</i> cm	<i>c</i> cm	<i>A</i>	<i>B</i>	<i>C</i>
(i)	43.17	46.44	24.15	67°	82°	31°
(j)	23.16	32.71	24.34	45°	87°	48°
(k)	50.00	52.91	38.64	64°	72°	44°
(l)	44.31	17.52	48.77	65°	21°	94°
(m)	12.68	23.49	22.34	32°	79°	69°
(n)	42.37	42.37	68.56	36°	36°	108°
(o)	40.70	15.65	41.26	77°	22°	81°

2. A car park is in the shape of a parallelogram. The lengths of the sides of the car park are given in metres.

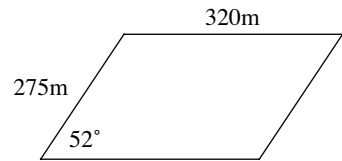

What is the area of the car park?

3. The diagram shows a circle of radius 10 cm. AB is a diameter of the circle. AC = 6 cm.

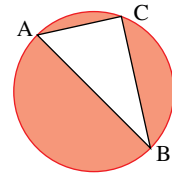

Find the area of the shaded region, giving an exact answer.

4. The triangle shown has an area of 110 cm². Find *x*.

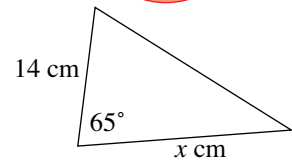

5. Find the area of the following

(a)

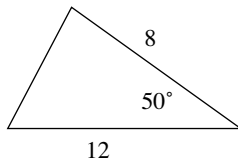

(b)

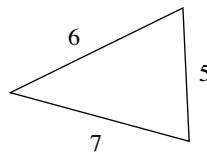

(c)

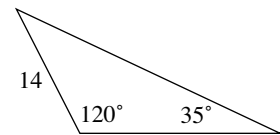

6. A napkin is in the shape of a quadrilateral with diagonals 9 cm and 12 cm long. The angle between the diagonals is 75°. What area does the napkin cover when laid out flat?

7. A triangle of area 50 cm² has side lengths 10 cm and 22 cm. What is the magnitude of the included angle?

8. A variable triangle OAB is formed by a straight line passing through the point $P(a, b)$ on the Cartesian plane and cutting the *x*-axis and *y*-axis at A and B respectively. If $\angle OAB = \theta$, find the area of $\triangle OAB$ in terms of *a*, *b* and θ .

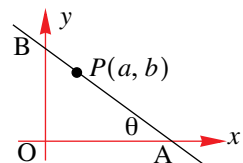

9. Find the area of $\triangle ABC$ for the given diagram.

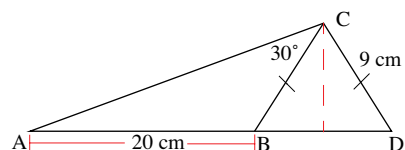

9.5 NON RIGHT-ANGLED TRIANGLES

9.5.1 THE SINE RULE

Previous sections dealt with the trigonometry of right-angled triangles. The trigonometric ratios can be used to solve non right-angled triangles. There are two main methods for solving non right-angled triangles, the **sine rule** and the **cosine rule** (which we look at later in this chapter). Both are usually stated using a standard labelling of the triangle. This uses capital letters to label the vertices and the corresponding small letters to label the sides opposite these vertices.

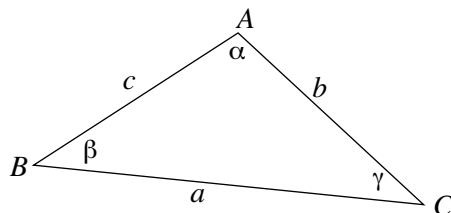

$$\begin{aligned} \sin A &= \sin \alpha \\ \sin B &= \sin \beta \\ \sin C &= \sin \gamma \end{aligned}$$

Using this labelling of a triangle, the sine rule can be stated as:

$$\frac{a}{\sin A} = \frac{b}{\sin B} = \frac{c}{\sin C} \quad \text{or} \quad \frac{\sin A}{a} = \frac{\sin B}{b} = \frac{\sin C}{c}$$

Note: the sine rule can only be used in a triangle in which an angle and the side **opposite** that angle are known.

So, why does this work?

Using the results of the last section and labelling a triangle in the standard manner we have:

$$\text{Area} = \frac{1}{2}bc \sin A,$$

$$\text{Area} = \frac{1}{2}ac \sin B$$

and

$$\text{Area} = \frac{1}{2}ab \sin C$$

However, each of these are equal, meaning that

$$\frac{1}{2}ac \sin B = \frac{1}{2}bc \sin A \Leftrightarrow a \sin B = b \sin A \Leftrightarrow \frac{a}{\sin A} = \frac{b}{\sin B}$$

Similarly,

$$\frac{1}{2}ac \sin B = \frac{1}{2}ab \sin C \Leftrightarrow c \sin B = b \sin C \Leftrightarrow \frac{c}{\sin C} = \frac{b}{\sin B}$$

Combining these results we have that

$$\frac{a}{\sin A} = \frac{b}{\sin B} = \frac{c}{\sin C}$$

So, when should/can we make use of the sine rule?

Although the sine rule can be used for right-angled triangles, it is more often used for situations when we do not have a right-angled triangle, and when the given triangle has either of the following pieces of information:

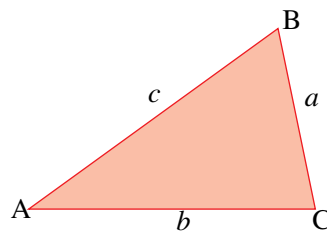

(a) Two angles and one side

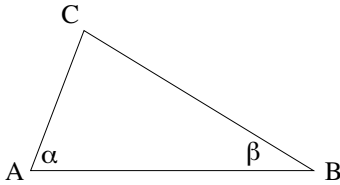

Either the length CB, AB or AC can be given and the triangle can be ‘solved’. i.e., we can find the length of every side and every angle.

In this case, if we are given the length AB, we need $\angle ACB$, which can be found using $\angle ACB = 180^\circ - \alpha - \beta$

(b) Two sides and a non-included angle

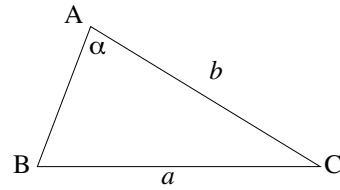

In this case, we first need to determine angle B using $\frac{\sin \alpha}{a} = \frac{\sin B}{b}$.

Once we have angle B, we can find angle C and then the length AB.

EXAMPLE 9.13

Solve the following triangles giving the lengths of the sides in centimetres, correct to one decimal place and angles correct to the nearest degree.

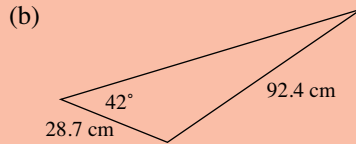
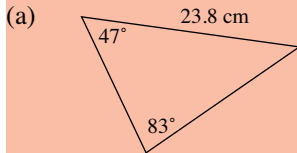

S
o
l
u
t
i
o
n

(a) Firstly, label the triangle using the standard method of lettering. ‘Solve the triangle’ means find all the angles and the lengths of all the sides. Since two of the angles are known, the third is; $C = 180^\circ - 47^\circ - 83^\circ = 50^\circ$. The lengths of the remaining sides can be found using the known pairing of side and angle, b and B .

$$\frac{a}{\sin A} = \frac{b}{\sin B} \Leftrightarrow \frac{a}{\sin 47^\circ} = \frac{23.8}{\sin 83^\circ}$$

$$a = \frac{23.8 \times \sin 47^\circ}{\sin 83^\circ}$$

$$= 17.5369\dots$$

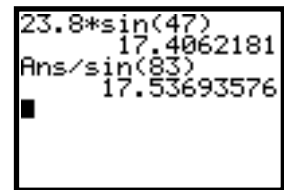
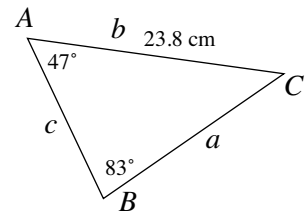

That is, BC is 17.5 cm (correct to one d.p).

Similarly, the remaining side can be calculated: $\frac{c}{\sin C} = \frac{b}{\sin B} \Leftrightarrow \frac{c}{\sin 50^\circ} = \frac{23.8}{\sin 83^\circ}$

$$\therefore c = \frac{23.8 \times \sin 50^\circ}{\sin 83^\circ}$$

$$= 18.3687\dots$$

That is, AB is 18.4 cm (correct to one d.p).

MATHEMATICS – Higher Level (Core)

- (b) This triangle is different from the previous example in that only one angle is known. It remains the case that a pair of angles and an opposite side are known and that the sine rule can be used. The angle A must be found first.

$$\begin{aligned}\frac{\sin A}{a} &= \frac{\sin B}{b} \Leftrightarrow \frac{\sin A}{28.7} = \frac{\sin 42^\circ}{92.4} \\ \Leftrightarrow \sin A &= \frac{28.7 \times \sin 42^\circ}{92.4} \\ &= 0.207836 \\ \therefore A &= \sin^{-1} 0.207836 \\ &= 11.9956^\circ \\ &= 11^\circ 59' 44''\end{aligned}$$

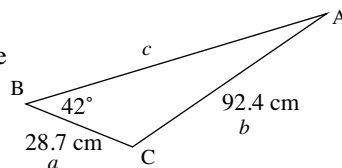

The answer to the first part of the question is 12° correct to the nearest degree. It is important, however, to carry a much more accurate version of this angle through to subsequent parts of the calculation. This is best done using the calculator memory.

The third angle can be found because the sum of the three angles is 180° .

$$\text{So, } C = 180^\circ - 12^\circ - 42^\circ = 126^\circ$$

An accurate version of this angle must also be carried to the next part of the calculation. Graphics calculators have multiple memories labelled A, B, C etc. and students are advised to use these in such calculations.

The remaining side is:

$$\frac{c}{\sin 126^\circ} = \frac{28.7}{\sin 12^\circ} \Leftrightarrow c = \frac{28.7 \sin 126^\circ}{\sin 12^\circ}$$

$$\therefore c = 111.6762\dots$$

That is, AB is 111.7 cm (correct to one d.p)

EXERCISES 9.5.1

Use the sine rule to complete the following table, which refers to the standard labelling of a triangle.

	<i>a</i> cm	<i>b</i> cm	<i>c</i> cm	<i>A</i>	<i>B</i>	<i>C</i>
1.			48.2		29°	141°
2.		1.2		74°	25°	
3.			11.3	60°		117°
4.			51.7	38°		93°
5.	18.5	11.4		68°		
6.	14.6	15.0			84°	
7.		7.3			16°	85°
8.			28.5	39°		124°
9.	0.8		0.8	82°		
10.			33.3	36°		135°
11.	16.4			52°	84°	

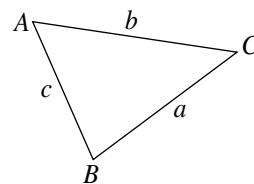

	a cm	b cm	c cm	A	B	C
12.			64.3		24°	145°
13.	30.9	27.7		75°		
14.			59.1	29°		102°
15.		9.8	7.9		67°	
16.			54.2	16°		136°
17.	14.8		27.2			67°
18.			10.9		3°	125°
19.			17.0		15°	140°
20.			40.1	30°		129°

EXAMPLE 9.14

For the triangle shown, find the angle ABC.

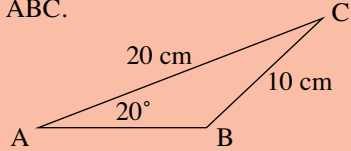

S
o
l
u
t
i
o
n

Making use of the sine rule we have:

$$\frac{\sin A}{a} = \frac{\sin B}{b} \Leftrightarrow \frac{\sin 20^\circ}{10} = \frac{\sin B}{20}$$

$$\Leftrightarrow \sin B = \frac{20 \sin 20^\circ}{10}$$

$$\therefore B = \sin^{-1}(2 \sin 20^\circ) = 43.1601\dots$$

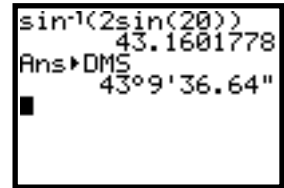

That is, $B = 43^\circ 10'$

However, from our diagram, the angle ABC should have been greater than 90° ! That is, we should have obtained an **obtuse angle** ($90^\circ < B < 180^\circ$) rather than an **acute angle** ($0^\circ < B < 90^\circ$).

So, what went wrong?

This example is a classic case of what is known as the **ambiguous case**, in that, from the given information it is possible to draw two different diagrams, both having the same data. We show both these triangles:

Case 1

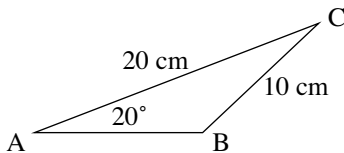

Case 2

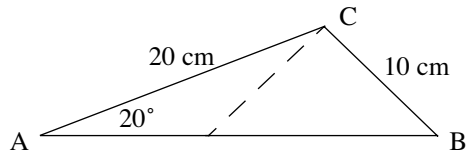

Notice that the side BC can be pivoted about the point C and therefore two different triangles can be formed with $BC = 10$. This is why there are two possible triangles based on the same information.

In the solution above, $B = 43^\circ 10'$ – representing Case 2. However, our diagram is represented by Case 1! Therefore, the correct answer is $180 - 43^\circ 10' = 136^\circ 50'$.

9.5.2 THE AMBIGUOUS CASE

From Example 9.14, it can be seen that an ambiguous case can arise when using the sine rule. In the given situation we see that the side CB can be pivoted about its vertex, forming two possible triangles.

We consider another such triangle.

EXAMPLE 9.15

Draw diagrams showing the triangles in which $AC = 17$ cm, $BC = 9$ cm and $A = 29^\circ$ and solve these triangles.

S
o
l
u
t
i
o
n

Applying the sine rule to the triangle gives:

$$\begin{aligned}\frac{\sin B}{17} &= \frac{\sin 29^\circ}{9} \Leftrightarrow \sin B = \frac{17 \times \sin 29^\circ}{9} \\ &= 0.91575 \\ \therefore B &= 66^\circ\end{aligned}$$

Next, we have,

$$C = 180^\circ - 29^\circ - 66^\circ = 85^\circ$$

$$\frac{c}{\sin 85^\circ} = \frac{9}{\sin 29^\circ} \Leftrightarrow c = 18.5$$

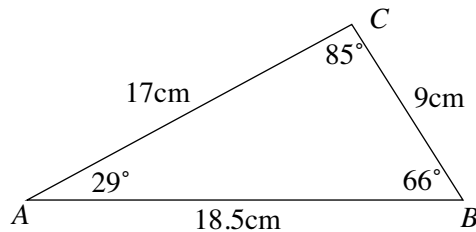

There is, however, a second solution that results from drawing an isosceles triangle BCE. This creates the triangle AEC which also fits the data. The third angle of this triangle is 37° and the third side is:

$$\frac{AE}{\sin 37^\circ} = \frac{9}{\sin 29^\circ} \Leftrightarrow AE = 11.2$$

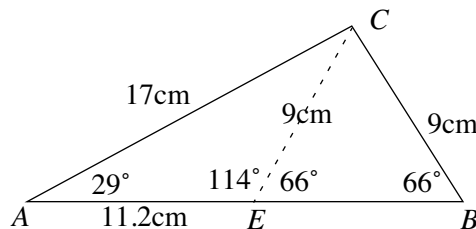

The original data is ambiguous in the sense that there are two triangles that are consistent with it.

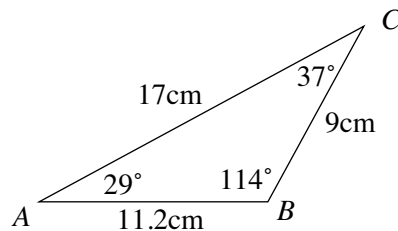
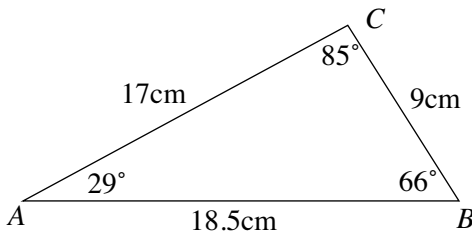

You should also notice that the two angles in the solution are 66° and 114° and that $\sin 66^\circ = \sin 114^\circ$. (That is, $\sin 66^\circ = \sin(180^\circ - 66^\circ) = \sin 114^\circ$. This will be developed further in Chapter 10).

In fact, we can go one step further and make the following statement:

If we are given two sides of a triangle and the magnitude of an angle opposite one of the sides, there may exist one, two or no possible solutions for the given information.

We summarise our findings:

Type 1

Given the **acute angle** α and the side lengths a and b , there are four possible outcomes:

Notice that the number of solutions **depends on** the length a relative to the perpendicular height, h , of the triangle as well as the length b . Where the height h is based on the right-angled triangle formed in each case, i.e., $\sin \alpha = \frac{h}{b} \Leftrightarrow h = b \sin \alpha$.

So that

- if $a < h$, then the triangle cannot be completed.
- if $a = h$, then we have a right-angled triangle.
- if $a > b$, then we have a triangle that is consistent with the given information.
- if $h < a < b$, then the side BC can be pivoted about the vertex C, forming two triangles.

Number of Δ s	Necessary condition	Type of triangle that can be formed
None	$a < h$	<p>In this case, the triangle cannot be constructed.</p>
One	$a = h$	<p>In this case we have formed a right-angled triangle.</p>
One	$a > b$	<p>In this case there can be only one triangle that is consistent with the given information.</p>
Two	$h < a < b$	<p>In this case there are two possible triangles, ΔABC and $\Delta AB'C$. This is because BC can be pivoted about C and still be consistent with the given information.</p>

The table above reflects the case where α is acute. What if α is obtuse?

Type 2

Given the **obtuse angle** α and the side lengths a and b , there are two possible outcomes:

Number of Δ s	Necessary condition	Type of triangle that can be formed
None	$a \leq b$	
One	$a > b$	

EXAMPLE 9.16

Find $\angle ABC$ for the triangle ABC given that $a = 50$, $b = 80$ and $A = 35^\circ$.

S
o
l
u
t
i
o
n

We first determine the value of $b \sin \alpha$ and compare it to the value a :

Now, $b \sin \alpha = 80 \sin 35^\circ = 45.89$

Therefore we have that $b \sin \alpha (= 45.89) < a (= 50) < b (= 80)$ meaning that we have an ambiguous case.

Case 1:

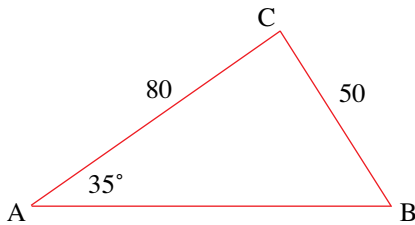

Using the sine rule, $\frac{\sin A}{a} = \frac{\sin B}{b}$, we have

$$\frac{\sin 35^\circ}{50} = \frac{\sin B}{80} \Leftrightarrow \sin B = \frac{80 \sin 35^\circ}{50}$$

$$\therefore B = 66^\circ 35'$$

Case 2:

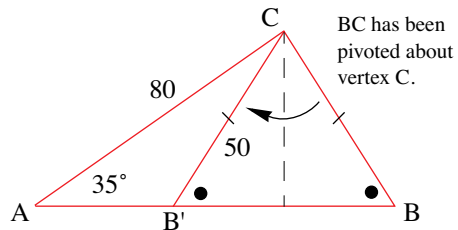

From case 1, the obtuse angle B' is given by $180^\circ - 66^\circ 35' = 113^\circ 25'$.

This is because $\Delta B'CB$ is an **isosceles**

triangle, so that $\angle AB'C = 180^\circ - \angle CB'B$

EXAMPLE 9.16

Find $\angle ACB$ for the triangle ABC given that $a = 70$, $c = 90$ and $A = 75^\circ$.

S
o
l
u
t
i
o
n

We start by drawing the triangle with the given information:
Using the sine rule we have

$$\frac{\sin C}{90} = \frac{\sin 75}{70} \Leftrightarrow \sin C = \frac{90 \sin 75}{70}$$

$$\therefore \sin C = 1.241\dots$$

Which is impossible to solve for as the sine of an angle can never be greater than one.
Therefore no such triangle exists.

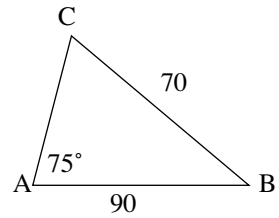

EXERCISES 9.5.2

Find the two solutions to these triangles which are defined using the standard labelling:

- | | <i>a</i> cm | <i>b</i> cm | <i>A</i> |
|-----|-------------|-------------|----------|
| 1. | 7.4 | 18.1 | 20° |
| 2. | 13.3 | 19.5 | 14° |
| 3. | 13.5 | 17 | 28° |
| 4. | 10.2 | 17 | 15° |
| 5. | 7.4 | 15.2 | 20° |
| 6. | 10.7 | 14.1 | 26° |
| 7. | 11.5 | 12.6 | 17° |
| 8. | 8.3 | 13.7 | 24° |
| 9. | 13.7 | 17.8 | 14° |
| 10. | 13.4 | 17.8 | 28° |
| 11. | 12.1 | 16.8 | 23° |
| 12. | 12 | 14.5 | 21° |
| 13. | 12.1 | 19.2 | 16° |
| 14. | 7.2 | 13.1 | 15° |
| 15. | 12.2 | 17.7 | 30° |
| 16. | 9.2 | 20.9 | 14° |
| 17. | 10.5 | 13.3 | 20° |
| 18. | 9.2 | 19.2 | 15° |
| 19. | 7.2 | 13.3 | 19° |
| 20. | 13.5 | 20.4 | 31° |

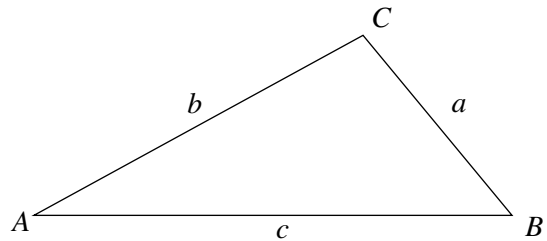

21. Solve the following triangles
- $\alpha = 75^\circ$, $a = 35$, $c = 45$
 - $\alpha = 35^\circ$, $a = 30$, $b = 80$
 - $\beta = 40^\circ$, $a = 22$, $b = 8$
 - $\gamma = 50^\circ$, $a = 112$, $c = 80$

9.5.3 APPLICATIONS OF THE SINE RULE

Just as in the case of right-angled triangles, the sine rule becomes very useful. In particular, it means that previous problems that required the partitioning of a non right-angled triangle into two (or more) right-angled triangles can be solved using the sine rule.

We start by considering Q.13., Exercise 9.2:

EXAMPLE 9.17

A surveying team are trying to find the height of a hill. They take a ‘sight’ on the top of the hill and find that the angle of elevation is $23^{\circ}27'$. They move a distance of 250 metres on level ground directly away from the hill and take a second ‘sight’. From this point, the angle of elevation is $19^{\circ}46'$. Find the height of the hill, correct to the nearest metre.

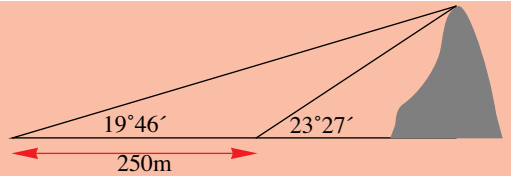

Solution

Labelling the given diagram using the standard notation we have:

$$\text{With } \beta = 180 - 23^{\circ}27' = 156^{\circ}33'$$

$$\text{and } \gamma = 180 - 19^{\circ}46' - 156^{\circ}33' = 3^{\circ}41'$$

Then, using the sine rule,

$$\frac{b}{\sin 156^{\circ}33'} = \frac{250}{\sin 3^{\circ}41'}$$

$$\Leftrightarrow b = \frac{250 \sin 156^{\circ}33'}{\sin 3^{\circ}41'}$$

$$= 1548.63\dots$$

Then, using $\triangle ACP$ we have,

$$\begin{aligned} \sin 19^{\circ}46' &= \frac{h}{b} \Leftrightarrow h = b \sin 19^{\circ}46' \\ &= 523.73 \end{aligned}$$

So, the hill is 524 m high (to nearest metre).

A much neater solution (as opposed to solving simultaneous equations – as was required previously).

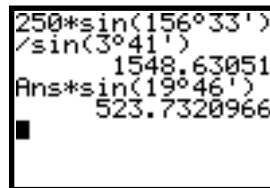
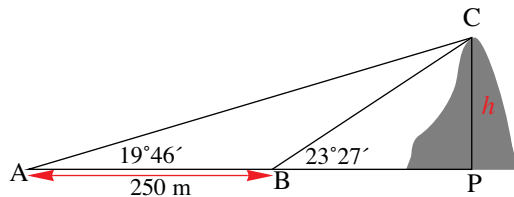

EXERCISES 9.5.3

1. A short course biathlon meet requires the competitors to run in the direction $S60^{\circ}W$ to their bikes and then ride $S40^{\circ}E$ to the finish line, situated 20 km due South of the starting point. What is the distance of this course?
2. A pole is slanting towards the sun and is making an angle of 10° to the vertical. It casts a shadow 7 metres long along the horizontal ground. The angle of elevation of the top of the pole to the tip of its shadow is 30° . Find the length of the pole, giving your answer to 2 d.p.

3. A statue A, is observed from two other statues B and C which are 330 m apart. The angle between the lines of sight AB and BC is 63° and the angle between the lines of sight AC and CB is 75° . How far is statue A from statue B?
4. Town A is 12 km from town B and its bearing is 132°T from B. Town C is 17 km from A and its bearing is 063°T from B. Find the bearing of A from C.
5. The angle of elevation of the top of a building from a park bench on level ground is 18° . The angle of elevation from a second park bench, 300 m closer to the base of the building is 30° . Assuming that the two benches and the building all lie on the same vertical plane, find the height of the building.
6. (a) A man standing 6 metres away from a lamp post casts a shadow 10 metres long on a horizontal ground. The angle of elevation from the tip of the shadow to the lamp light is 12° . How high is the lamp light?
 (b) If the shadow is cast onto a road sloping at 30° upwards, how long would the shadow be if the man is standing at the foot of the sloping road and 6 metres from the lamp post?
7. At noon the angle of elevation of the sun is 72° and is such that a three metre wall AC, facing the sun, is just in the shadow due to the overhang AB.

The angle that the overhang makes with the vertical wall is 50° .

- (a) Copy and illustrate this information on the diagram shown.
- (b) Find the length of the overhang.

At 4 p.m. the angle of elevation of the sun is 40° and the shadow due to the overhang just reaches the base of the window.

- (c) How far from the ground is the window?

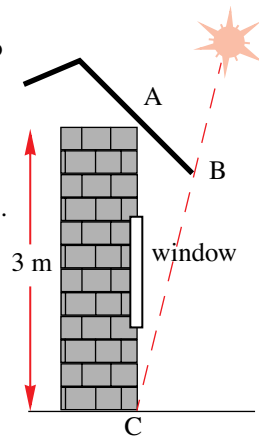

8. The lookout on a ship sailing due East at 25 km/h observes a reef $\text{N}62^\circ\text{E}$ at a distance of 30 km.
 - (a) How long will it be before the ship is 15 km from the reef, assuming that it continues on its easterly course.
 - (b) How long is it before it is again 15 km from the reef?
 - (c) What is the closest that the ship will get to the reef?
9. The framework for an experimental design for a kite is shown. Material for the kite costs \$12 per square cm. How much will it cost for the material if it is to cover the framework of the kite.

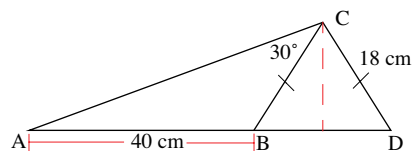

10. A boy walking along a straight road notices the top of a tower at a bearing of 284°T . After walking a further 1.5 km he notices that the top of the tower is at a bearing of 293°T . How far from the road is the tower?

9.5.4 THE COSINE RULE

Sometimes the sine rule is not enough to help us solve for a non right-angled triangle. For example, in the triangle shown, we do not have enough information to use the sine rule. That is, the sine rule only provided the following:

$$\frac{a}{\sin 30^\circ} = \frac{14}{\sin B} = \frac{18}{\sin C}$$

where there are too many unknowns.

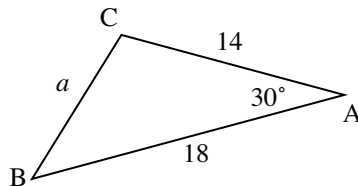

For this reason we derive another useful result, known as the cosine rule. The cosine rule may be used when

- 1. two sides and an included angle are given:**
This means that the third side can be determined and then we can make use of the sine rule (or the cosine rule again).
- 2. three sides are given:**
This means we could then determine any of the angles.

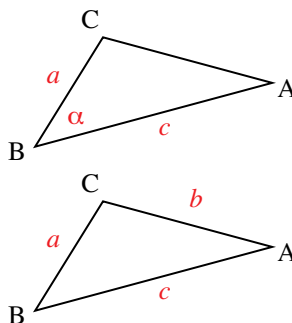

The cosine rule, with the standard labelling of the triangle has three versions:

$$\begin{aligned} a^2 &= b^2 + c^2 - 2bc \cos A \\ b^2 &= a^2 + c^2 - 2ac \cos B \\ c^2 &= a^2 + b^2 - 2ab \cos C \end{aligned}$$

The cosine rule can be remembered as a version of Pythagoras's Theorem with a correction factor. We now show why this works.

Consider the case where there is an acute angle at A. Draw a perpendicular from C to N as shown in the diagram.

In $\triangle ANC$ we have $b^2 = h^2 + x^2$
 $\Leftrightarrow h^2 = b^2 - x^2$ — (1)

In $\triangle BNC$ we have $a^2 = h^2 + (c - x)^2$
 $\Leftrightarrow h^2 = a^2 - (c - x)^2$ — (2)

Equating (1) and (2) we have,
 $a^2 - (c - x)^2 = b^2 - x^2$
 $\Leftrightarrow a^2 - c^2 + 2cx - x^2 = b^2 - x^2$
 $\Leftrightarrow a^2 = b^2 + c^2 - 2cx$

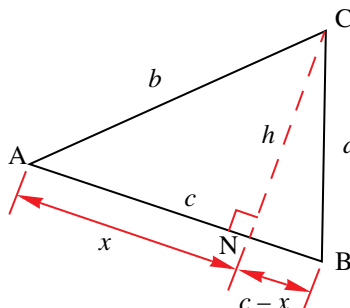

However, from $\triangle ANC$ we have that $\cos A = \frac{x}{b} \Leftrightarrow x = b \cos A$

Substituting this result for x , we have

$$a^2 = b^2 + c^2 - 2cb \cos A$$

Although we have shown the result for an acute angle at A, the same rule applies if A is obtuse.

EXAMPLE 9.18

Solve the following triangles giving the lengths of the sides in centimetres, correct to one decimal place and angles correct to the nearest degree.

(a)

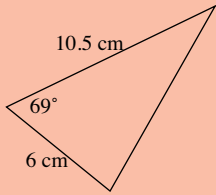

(b)

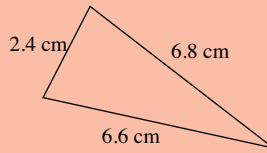
**S
o
l
u
t
i
o
n**

- (a) The data does not include an angle and the opposite side so the sine rule cannot be used. The first step, as with the sine rule, is to label the sides of the triangle. Once the triangle has been labelled, the correct version of the cosine rule must be chosen. In this case, the solution is:

$$\begin{aligned}c^2 &= a^2 + b^2 - 2ab \cos C \\c^2 &= 10.5^2 + 6^2 - 2 \times 10.5 \times 6 \times \cos 69^\circ \\&= 101.0956 \\a &= 10.1\end{aligned}$$

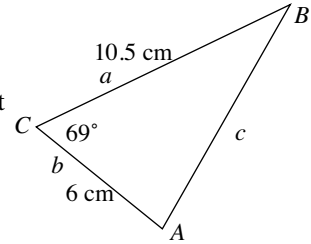

The remaining angles can be calculated using the sine rule. Again, it is important to carry a high accuracy for the value of c to the remaining problem:

$$\frac{\sin B}{b} = \frac{\sin C}{c} \Leftrightarrow \sin B = \frac{6 \times \sin 69^\circ}{10.0546} \therefore B = 34^\circ$$

Finally, $A = 180^\circ - 34^\circ - 69^\circ = 77^\circ$

- (b) In this case, there are no angles given. The cosine rule can be used to solve this problem as follows:

$$\begin{aligned}a^2 &= b^2 + c^2 - 2bc \cos A \\6.6^2 &= 2.4^2 + 6.8^2 - 2 \times 2.4 \times 6.8 \times \cos A \\2 \times 2.4 \times 6.8 \times \cos A &= 2.4^2 + 6.8^2 - 6.6^2 \\\cos A &= \frac{2.4^2 + 6.8^2 - 6.6^2}{2 \times 2.4 \times 6.8} \\&= 0.25858 \\A &= 75.014^\circ \\&= 75^\circ 1'\end{aligned}$$

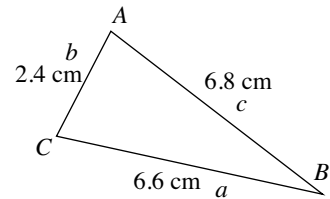

Next, use the sine rule: $\frac{\sin B}{b} = \frac{\sin A}{a} \Leftrightarrow \sin B = \frac{2.4 \times \sin 75^\circ}{6.6} \therefore B = 20^\circ 34'$

So that $C = 180^\circ - 75^\circ - 21^\circ = 84^\circ$

The three angles, correct to the nearest degree are $A = 75^\circ$, $B = 21^\circ$ & $C = 84^\circ$.

EXERCISES 9.5.4

Solve the following triangles

	<i>a</i> cm	<i>b</i> cm	<i>c</i> cm	<i>A</i>	<i>B</i>	<i>C</i>
1.	13.5		16.7		36°	
2.	8.9	10.8				101°
3.	22.8		12.8		87°	
4.	21.1	4.4				83°
5.		10.6	15.1	74°		
6.		13.6	20.3	20°		
7.	9.2		13.2		46°	
8.	23.4	62.5				69°
9.		9.6	15.7	41°		
10.	21.7	36.0	36.2			
11.	7.6	3.4	9.4			
12.	7.2	15.2	14.3			
13.	9.1		15.8		52°	
14.	14.9	11.2	16.2	63°	42°	75°
15.	2.0	0.7	2.5			
16.	7.6	3.7	9.0			
17.	18.5	9.8	24.1			
18.	20.7	16.3	13.6			
19.		22.4	29.9	28°		
20.	7.0		9.9		42°	
21.	21.8	20.8	23.8			
22.	1.1		1.3		89°	
23.		1.2	0.4	85°		
24.	23.7	27.2				71°
25.	3.4	4.6	5.2			

9.5.5 APPLICATIONS OF THE COSINE RULE

EXAMPLE 9.19

A cyclist rode her bike for 22 km on a straight road heading in a westerly direction towards a junction. Upon reaching the junction, she headed down another straight road bearing 200°T for a distance of 15 km. How far is the cyclist from her starting position?

S
o
l
u
t
i
o
n

We start with a diagram:

Note that $\angle ABC = 90^\circ + 20^\circ = 110^\circ$

Using the cosine rule we have,

$$AC^2 = 15^2 + 22^2 - 2 \times 15 \times 22 \cos 110^\circ$$

$$\Rightarrow AC = \sqrt{225 + 484 - 660 \times (-0.3420\dots)}$$

$$\therefore AC = 30.5734\dots$$

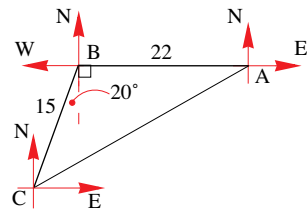

That is, she is (approximately) 30.57 km from her starting point.

EXAMPLE 9.20

A yacht starts from a harbour and sails for a distance of 11 km in a straight line. The yacht then makes a turn to port (left) of 38° and sails for 7 km in a straight line in this new direction until it arrives at a small island. Draw a diagram that shows the path taken by the yacht and calculate the distance from the harbour to the island.

**S
o
l
u
t
i
o
n**

The question does not give the bearing of the first leg of the trip so the diagram can show this in any direction. H is the harbour, I the island and T the point where the yacht makes its turn.

The angle in the triangle at T is $180^\circ - 38^\circ = 142^\circ$. The problem does not contain an angle and the opposite side and so must be solved using the cosine rule.

$$\begin{aligned} t^2 &= h^2 + i^2 - 2hi\cos T \\ &= 7^2 + 11^2 - 2 \times 7 \times 11 \times \cos 142^\circ \\ &= 291.354 \end{aligned}$$

$$\therefore t = 17.1$$

That is, distance from the harbour to the port is 17.1 km (to one d.p)

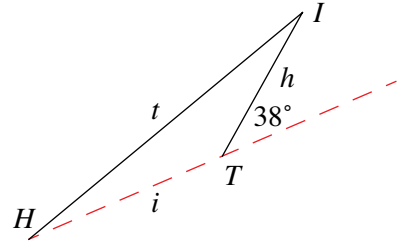
EXAMPLE 9.21

A triangular sandpit having side lengths 5 m, 4 m and 8 m is to be constructed to a depth of 20 cm. Find the volume of sand required to fill this sandpit.

**S
o
l
u
t
i
o
n**

We will need to find an angle. In this case we determine the largest angle, which will be the angle opposite the longest side.

From our diagram we have

$$\begin{aligned} 8^2 &= 4^2 + 5^2 - 2 \times 4 \times 5 \cos C \\ \therefore 64 &= 16 + 25 - 40 \cos C \\ \Leftrightarrow \cos C &= \frac{16 + 25 - 64}{40} \end{aligned}$$

$$= -\frac{23}{40}$$

$$\therefore C = 125^\circ 6'$$

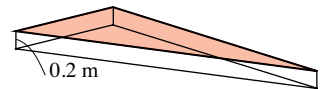
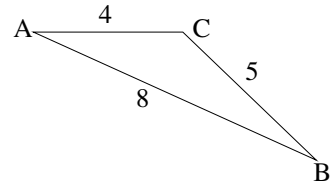

To find the volume of sand we first need to find the surface area of the sandpit.

$$\text{Area} = \frac{1}{2}ab\sin C = \frac{1}{2} \times 4 \times 5 \times \sin(125^\circ 6') = 8.1815 \text{ m}^2.$$

Therefore, volume of sand required is $0.2 \times 8.1815 = 1.64 \text{ m}^3$.

EXERCISES 9.5.5

- Thomas has just walked 5 km in a direction $N70^\circ E$ when he realises that he needs to walk a further 8 km in a direction $E60^\circ S$.
 - How far from the starting point will Thomas have travelled?
 - What is his final bearing from his starting point?
- Two poles, 8 m apart are facing a rugby player who is 45 m from the left pole and 50 from the right one. Find the angle that the player makes with the goal mouth.
- The lengths of the adjacent sides of a parallelogram are 4.80 cm and 6.40 cm. If these sides have an inclusive angle of 40° , find the length of the shorter diagonal.
- During an orienteering venture, Patricia notices two rabbit holes and estimates them to be 50 m and 70 m away from her. She measures the angle between the line of sight of the two holes as 54° . How far apart are the two rabbit holes?
- To measure the length of a lake, a surveyor chooses three points. Starting at one end of the lake she walks in a straight line for 223.25 m to some point X, away from the lake. She then heads towards the other end of the lake in a straight line and measures the distance covered to be 254.35 m. If the angle between the paths she takes is $82^\circ 25'$, find the width of the lake.
- A light airplane flying $N87^\circ W$ for a distance of 155 km, suddenly needs to alter its course and heads $S 34^\circ E$ for 82 km to land on an empty field.
 - How far from its starting point did the plane land.
 - What was the plane's final bearing from its starting point?

EXERCISES 9.5.6 – MISCELLANEOUS EXERCISES

- The diagram shows a triangular building plot. The distances are given in metres. Find the length of the two remaining sides of the plot giving your answers correct to the nearest hundredth of a metre.
- Xiang is standing on level ground. Directly in front of him and 32 metres away is a flagpole. If Xiang turns 61° to his right, he sees a post box 26.8 metres in front of him. Find the distance between the flagpole and the post box.
- A triangular metal brace is part of the structure of a bridge. The lengths of the three parts are shown in metres. Find the angles of the brace.

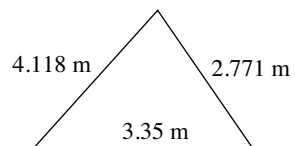
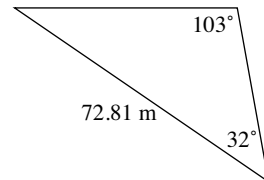

- Find the smallest angle in the triangle whose sides have length 35.6 cm, 58.43 cm and 52.23 cm.

5. Ayton is directly north of Byford. A third town, Canfield, is 9.93km from Ayton on a bearing of 128° true. The distance from Byford to Canfield is 16.49km. Find the bearing of Canfield from Byford.
6. A parallelogram has sides of length 21.90 cm and 95.18 cm. The angle between these sides is 121° . Find the length of the long diagonal of the parallelogram.
7. A town clock has ‘hands’ that are of length 62cm and 85cm.
 (a) Find the angle between the hands at half past ten.
 (b) Find the distance between the tips of the hands at half past ten.

8. A shop sign is to be made in the shape of a triangle. The lengths of the edges are shown. Find the angles at the vertices of the sign.

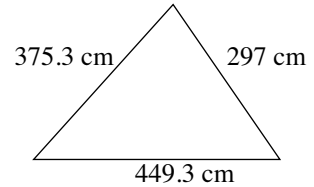

9. An aircraft takes off from an airstrip and then flies for 16.2 km on a bearing of 066° true. The pilot then makes a left turn of 88° and flies for a further 39.51 km on this course before deciding to return to the airstrip.
 (a) Through what angle must the pilot turn to return to the airstrip?
 (b) How far will the pilot have to fly to return to the airstrip?

10. A golfer hits two shots from the tee to the green.
 How far is the tee from the green?

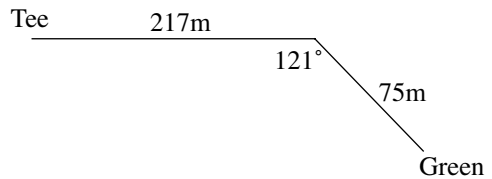

11. The diagram shows a parallelogram. Find the length of the longer of the two diagonals.

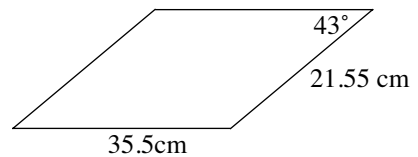

12. A triangle has angles 64° , 15° and 101° . The shortest side is 49 metres long. What is the length of the longest side?

13. The diagram shows a part of the support structure for a tower. The main parts are two identical triangles, ABC and ADE.
 $AC = DE = 27.4$ cm and $BC = AE = 23.91$ cm
 The angles ACB and AED are 58° .
 Find the distance BD.

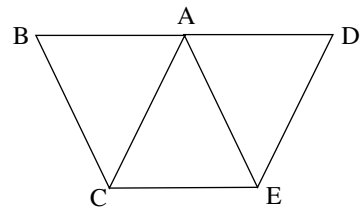

MATHEMATICS – Higher Level (Core)

- 14.** The diagram shows a design for the frame of a piece of jewellery. The frame is made of wire.

Find the length of wire needed to make the frame.

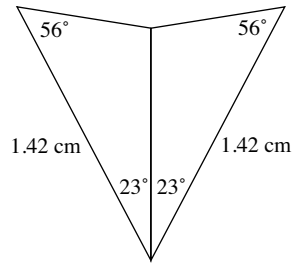

- 15.** A triangular cross-country running track begins with the runners running North for 2050 metres. The runners then turn right and run for 5341 metres on a bearing of 083° true. Finally, the runners make a turn to the right and run directly back to the starting point.
- Find the length of the final leg of the run.
 - Find the total distance of the run.
 - What is the angle through which the runners must turn to start the final leg of the race?
 - Find the bearing that the runners must take on the final leg of the race.

- 16.** Show that for any standard triangle ABC, $\frac{\cos A}{a} + \frac{\cos B}{b} + \frac{\cos C}{c} = \frac{a^2 + b^2 + c^2}{2abc}$.

- 17.** A sandpit in the shape of a pentagon ABCDE is to be built in such a way that each of its sides are of equal length, but its angles are not all equal.

The pentagon is symmetrical about DX, where X is the midpoint of AB.

The angle AXE and BXC are both 45° and each side is 2 m long.

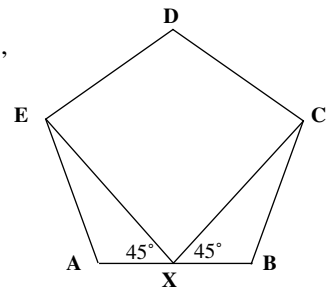

- Find $\angle XEA$.
- Find the length of EX.
- How much sand is required if the sandpit is 30 cm deep? Give your answer to three decimal place.

- 18.** A triangular region has been set aside for a housing development which is to be divided into two sections. Two adjacent street frontages, AB and AC measuring 100 m and 120 m respectively. With the 100 m frontage running in an easterly direction, while the 120 m frontage runs in a north-east direction. A plan for this development is shown alongside. Give all answers to the nearest metre.

- Find the area covered by the housing development.

During the development stages, an environmental group specified that existing trees were not to be removed from the third frontage. This made it difficult for the surveyors to measure the length of the third frontage.

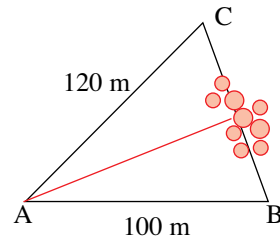

- Calculate the length of the third frontage, BC.

The estate is to be divided into 2 regions, by bisecting the angle at A with a stepping wall running from A to the frontage BC.

- How long is this stepping wall?

9.6 MORE APPLICATIONS IN 3-D

EXAMPLE 9.22

A vertical tower PA is due West of a point B . From C , bearing 210° and 500 m from B , the bearing of the foot of the tower A is 290° , and the angle of elevation of the top of the tower P is 1.5° . The points A , B and C are on level ground. Given that h is the height of the tower, show that $h = \frac{250\sqrt{3}\tan 1.5^\circ}{\sin 20^\circ}$ and find the height to the nearest metre.

S
o
l
u
t
i
o
n

We start by drawing a diagram to depict the situation, producing both a perspective and aerial diagram:

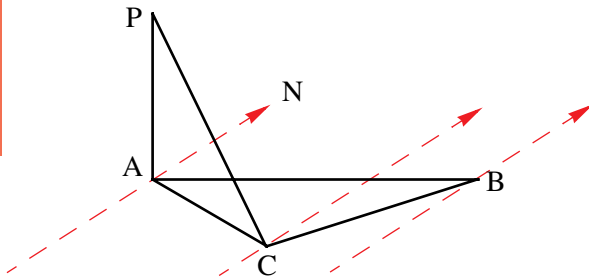

Figure 1

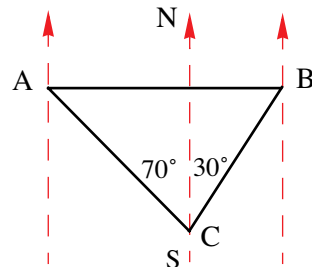

Figure 2

In figure 1, $PA = h$, $\angle PCA = 1.5^\circ$ and thus, $h = AC \times \tan 1.5^\circ$.

In figure 2, $\angle NCA = 70^\circ$ ($= 360^\circ - \text{bearing of A from C}$), $\angle NCB = 30^\circ$ (alternate to $\angle CBS$) and $\angle ABC = 60^\circ$ (complementary to $\angle CBS$) and thus, $\angle CAB = 20^\circ$ (using the angle sum of a triangle).

In $\triangle ABC$ we have (using the sine rule) that $\frac{AC}{\sin 60^\circ} = \frac{500}{\sin 20^\circ} \Leftrightarrow AC = \frac{500}{\sin 20^\circ} \times \sin 60^\circ$

But, $AC = \frac{h}{\tan 1.5^\circ}$ (from above), $\therefore \frac{h}{\tan 1.5^\circ} = \frac{500}{\sin 20^\circ} \times \sin 60^\circ$

$$\Leftrightarrow h = \tan 1.5^\circ \times \frac{500}{\sin 20^\circ} \times \sin 60^\circ$$

$$= \tan 1.5^\circ \times \frac{500}{\sin 20^\circ} \times \frac{\sqrt{3}}{2}$$

$$= \frac{250\sqrt{3}\tan 1.5^\circ}{\sin 20^\circ}$$

$$= 33 \text{ (to the nearest metre)}$$

That is, the height of the tower (to the nearest metre) is 33 m.

EXERCISES 9.6

1. A rectangular box is constructed as shown, with measurements $HG = 10$ cm, $\angle FHE = 30^\circ$, $\angle CEG = 15^\circ$. Find the height of the box.

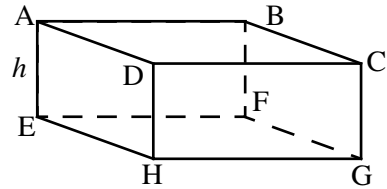

2. From a point A due South of a vertical tower, the angle of elevation of the top of the tower is 15° , and from a point B due West of the tower it is 32° . If the distance from A to B is 50 metres, find the height of the tower.
3. From a point P, the angle of elevation of the top of a radio mast due North of P is 17° . From Q, due West of the radio mast, the angle of elevation is 13° . Given that P and Q are 130 m apart, show that h , the height of the mast, can be given by

$$h = \frac{130}{\sqrt{\tan^2 73 + \tan^2 77}}$$

and find h to the nearest m.

4. From a point due South of a radio tower, an observer measures the angle of elevation to the top of the tower to be 41° . A second observer is standing on a bearing of 130° from the base of the tower, and on a bearing of 50° from the first observer. If the height of the tower is 45m, find the distance between the two observers, and the angle of elevation of the top of the tower as measured by the second observer.
5. A small plane is flying due east at a constant altitude of 3 km and a constant speed of 120 km/h. It is approaching a small control tower that lies to the South of the plane's path. At time t_0 the plane is on a bearing of 300° from the tower, and elevated at 4.5° . How long does it take for the plane to be due North of the tower, and what is its angle of elevation from the tower at this time?
6. A plane is flying at a constant altitude h with a constant speed of 250km/h. At 10:30 AM it passes directly over a town T heading towards a second town R. A fisherman located next to a river 50km due South of T observes the angle of elevation to the plane to be 4.5° . Town R lies on a bearing of 300° from where the fisherman is standing, and when the plane flies directly over R, the angle of depression to the fisherman is 2.5° . At what time does the plane pass directly over town R?
7. Frank and Stella are walking along a straight road heading North, when they spot the top of a tower in the direction $N\theta^\circ E$, behind low lying trees. The angle of elevation to the top of the tower is α° . After walking d m along the road they notice that the tower is now $N\phi^\circ E$ of the road and that the angle of elevation of the top of the tower is now β° . Let the height of the tower be h m.
- Find the distance of the tower from the
 - first sighting.
 - second sighting.
 - Find an expression of the height, h m, of the tower.
 - How much further must Stella and Frank walk before the tower is located in an easterly direction?

9.7 ARCS, SECTORS AND SEGMENTS

9.7.1 RADIAN MEASURE OF AN ANGLE

So far we have been dealing with angles that have been measured in degrees. However, while this has been very useful, such measurements are not suitable for many topics in mathematics. Instead, we introduce a new measure, called the **radian measure**.

The degree measure of angle is based on dividing the complete circle into 360 equal parts known as degrees. Each degree is divided into sixty smaller parts known as minutes, and each minute is divided into sixty seconds.

Decimal parts of a degree can be converted into degrees, minutes and seconds using the **2nd ANGLE** menu and selecting option 4.

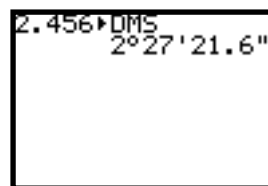
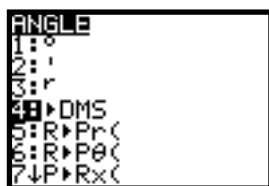

This can be useful as calculators generally produce answers in the decimal format. It should also be noted that the degree, minute, second angle system is the same as the hours minutes seconds system that we use to measure time. The above screen could be interpreted as 2.456° and is equal to 2 degrees 27 minutes and 21.6 seconds or as 2.456 hours which is the same as 2 hours 27 minutes and 21.6 seconds.

The degree system is arbitrary in the sense that the decision was made (in the past and due to astronomical measurements) to divide the complete circle into 360 parts. The radian system is an example of a natural measurement system.

One radian is defined as the size of angle needed to cut off an arc of the same length as the radius.

Two radians is the angle that gives an arc length of twice the radius, etc., giving a natural linear conversion between the measure of a radian, the arc length and the radius of a circle.

A complete circle has an arc length of $2\pi r$. It follows that a complete circle corresponds to

$\frac{2\pi r}{r} = 2\pi$ radians. This leads to the conversion factor between these two systems:

$$360^\circ = 2\pi \text{ radians or } 180^\circ = \pi \text{ radians (often written as } \pi^c \text{)}$$

So, exactly how large is a radian?

Using the conversion above, if $360^\circ = 2\pi^c$, then $1^c = \frac{360}{2\pi} \approx 57.2957^\circ$

That is, the angle which subtends an **arc of length 1 unit** in a **circle of radius 1 unit**, is **1 radian**.

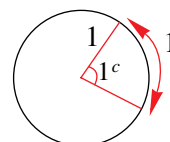

MATHEMATICS – Higher Level (Core)

More generally we have:

To convert from **degrees to radians**, multiply angle by $\frac{\pi^c}{180}$.

To convert from **radians to degrees**, multiply angle by $\frac{180}{\pi^c}$.

All conversions between the two systems follow this ratio. It is not generally necessary to convert between the systems as problems are usually worked either entirely in the degree system (as in the previous sections) or in radians (as in the functions and calculus chapters). In the case of arc length and sector areas, it is generally better to work in the radian system.

EXAMPLE 9.23

Convert

- (a) 70° into radians (b) 2.34^c into degrees (c) $\frac{\pi^c}{6}$ into degrees

S
o
l
u
t
i
o
n

Using the above conversion factors we have:

(a) $70^\circ = 70 \times \frac{\pi^c}{180} = \frac{7\pi^c}{18}$ or 1.2217^c

(b) $2.34^c = 2.34 \times \frac{180^\circ}{\pi} = 134.0721^\circ = 134^\circ 4' 20''$

(c) $\frac{\pi^c}{6} = \frac{\pi}{6} \times \frac{180^\circ}{\pi} = 30^\circ$

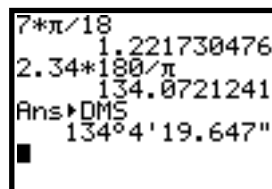

9.7.2 ARC LENGTH

As the arc length AB of a circle is directly proportional to the angle which AB subtends at its centre, then, the arc length AB is a fraction of the circumference of the circle of radius r .

So, if the angle is θ^c , then the arc length is $\frac{\theta}{2\pi}$ of the circumference.

Then, the **(minor) arc length**, AB, denoted by l , is given by $l = \frac{\theta}{2\pi} \times 2\pi r = r\theta$.

i.e.,

$$l = r\theta^c$$

The longer arc AB, called the **major arc**, has a length of $2\pi r - l$.

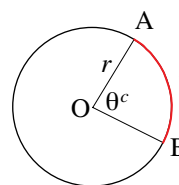

EXAMPLE 9.24

Using the circle shown, find the arc length AB.

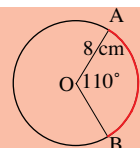

First we need to convert 110° into radian measure.

$$110^\circ = 110 \times \frac{\pi^c}{180} = \frac{11\pi^c}{18}$$

$$\begin{aligned} \text{Then, the arc length, } l, \text{ is given by, } l = r\theta &= 8 \times \frac{11\pi}{18} = \frac{44\pi}{9} \\ &= 15.3588\dots \end{aligned}$$

Therefore, the arc length is 15.36 cm.

9.7.3 AREA OF SECTOR

The formula for the area of a sector is derived as follows:

If a sector is cut from a circle of radius r using an angle at the centre of θ radians, the area of the complete circle is πr^2 . The fraction of the circle that forms the sector is $\frac{\theta}{2\pi}$ of the complete circle, so the area of the sector is $\pi r^2 \times \frac{\theta}{2\pi} = \frac{1}{2}r^2\theta$.

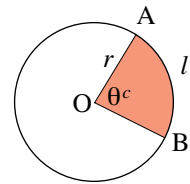

i.e.,

$$A = \frac{1}{2}r^2\theta^c$$

EXAMPLE 9.25

Find the area and perimeter of the sector shown

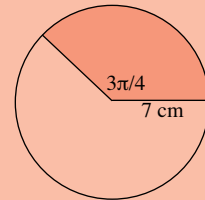

$$\text{Area of sector} = \frac{1}{2} \times 7^2 \times \frac{3\pi}{4} = \frac{147\pi}{8} \text{ cm}^2$$

$$\text{The perimeter is made up from two radii (14 cm) and the arc } l = r\theta = 7 \times \frac{3\pi}{4} = \frac{21\pi}{4}$$

$$\text{The perimeter is } 14 + \frac{21\pi}{4} \text{ cm.}$$

EXAMPLE 9.25

Find the area and perimeter of the shaded part of the diagram. The radius of the inner circle is 4 cm and the radius of the outer circle is 9 cm.

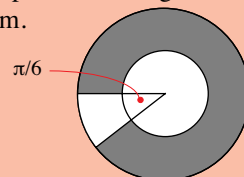

The angle of the shaded segment = $2\pi - \frac{\pi}{6} = \frac{11\pi}{6}$

The shaded area can be found by subtracting the area of the sector in the smaller circle from that in the larger circle.

$$\text{Shaded area} = \frac{1}{2} \times 9^2 \times \frac{11\pi}{6} - \frac{1}{2} \times 4^2 \times \frac{11\pi}{6} = \frac{11\pi}{12}(9^2 - 4^2) = 59\frac{7}{12}\pi \text{ cm}^2$$

The perimeter is made up from two straight lines (each $9 - 4 = 5$ cm long) and two arcs.

$$\text{Perimeter} = 10 + 4 \times \frac{11\pi}{6} + 9 \times \frac{11\pi}{6} = 10 + \frac{143\pi}{6} \text{ cm.}$$

EXERCISES 9.7

1. Find the areas and perimeters of the following sectors:

	Radius	Angle		Radius	Angle
i.	2.6cm	$\frac{\pi}{3}$	ii.	11.5cm	$\frac{\pi}{4}$
iii.	44cm	$\frac{\pi}{4}$	iv.	6.8m	$\frac{2\pi}{3}$
v.	0.64cm	$\frac{3\pi}{4}$	vi.	7.6cm	$\frac{5\pi}{6}$
vii.	324m	$\frac{\pi}{10}$	viii.	8.6cm	$\frac{7\pi}{6}$
ix.	6.2cm	$\frac{4\pi}{3}$	x.	76m	$\frac{11\pi}{6}$
xi.	12cm	30°	xii.	14m	60°
xiii.	2.8cm	120°	xiv.	24.8cm	270°
xv.	1.2cm	15°			

2. A cake has a circumference of 30cm and a uniform height of 7cm. A slice is to be cut from the cake with two straight cuts meeting at the centre. If the slice is to contain 50cm^3 of cake, find the angle between the two cuts, giving the answer in radians to 2 significant figures and in degrees correct to the nearest degree.

3. The diagram shows a part of a Norman arch. The dimensions are shown in metres.

Find the volume of stone in the arch, giving your answer in cubic metres, correct to three significant figures.

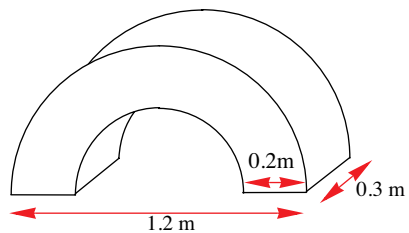

4. In the diagram, find the value of the angle A in radians, correct to three significant figures, if the perimeter is equal to 40cm.

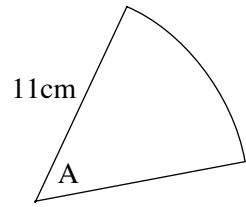

5. The diagram shows a design for a shop sign. The arcs are each one quarter of a complete circle. The radius of the smaller circle is 7 cm and the radius of the larger circle is 9cm.

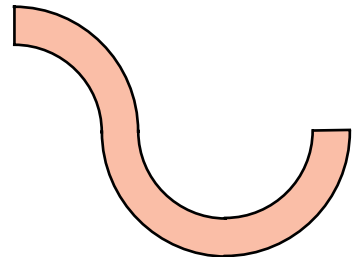

Find the perimeter of the shape, correct to the nearest centimetre.

6. Find the shaded area in the diagram. The dimensions are given in centimetres. O is the centre of the circle and AT is a tangent.

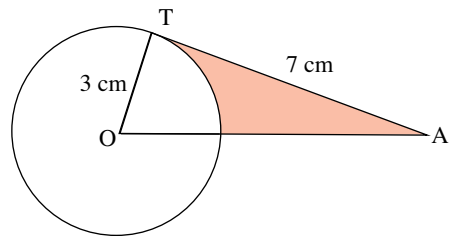

Give your answer correct to three significant figures.

7. The diagram shows a running track. The perimeter of the inside line is 400 metres and the length of each straight section is 100 metres.

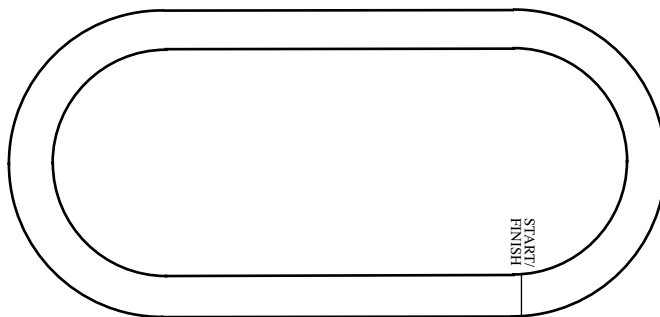

- (a) Find the radius of each of the semi-circular parts of the inner track.
 (b) If the width of the lane shown is 1 metre, find the perimeter of the outer boundary of the lane.

A second lane is added on the outside of the track. The starting positions of runners who have to run (anti-clockwise) in the two lanes are shown.

- (c) Find the value of angle A° (to the nearest degree) if both runners are to run 400 metres.

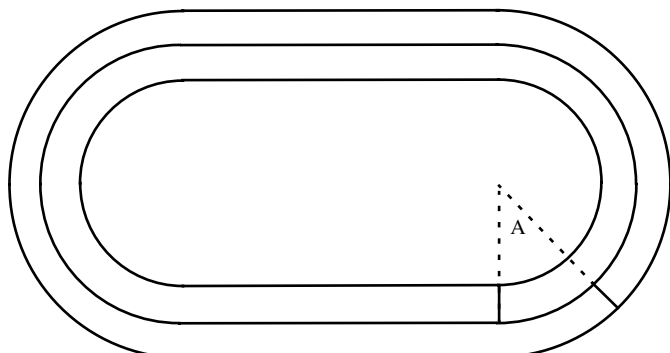

MATHEMATICS – Higher Level (Core)

- 8.** Find the angle subtended at the centre of a circle of radius length 12 cm by an arc which forms a sector of area 80 sq. cm
- 9.** Find the angle subtended at the circumference of a circle of radius length 10 cm by an arc which forms a sector of area 75 sq. cm
- 10.** A chord of length 32 cm is drawn in a circle of radius 20 cm.
 (a) Find the angle it subtends at the centre.
 (b) Find :
 i. the minor arc length.
 ii. the major arc length.
 (c) Find the area of the minor sector.

- 11.** Two circles of radii 6 cm and 8 cm have their centres 10 cm apart. Find the area common to both circles.

- 12.** Two pulleys of radii 16 cm and 20 cm have their centres 40 cm apart. Find the length of the piece of string that will be required to pass tightly round the circles if the string does not cross over.

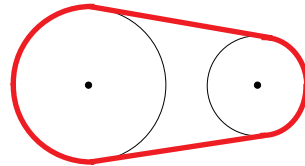

- 13.** Two pulleys of radii 7 cm and 11 cm have their centres 24 cm apart. Find the length of the piece of string that will be required to pass tightly round the circles if
 (a) the string cannot cross over.
 (b) the string crosses over itself.

- 14.** A sector of a circle has a radius of 15 cm and an angle of 216° . The sector is folded in such a way that it forms a cone, so that the two straight edges of the sector do not overlap.
 (a) Find the base radius of the cone.
 (b) Find the vertical height of the cone.
 (c) Find the semi-vertical angle of the cone.

- 15.** A taut belt passes over two discs of radii 12 cm and 4 cm as shown in the diagram.

- (a) If the total length of the belt is 88 cm, show that
 $1 = (5.5 - \pi - \alpha) \tan \alpha$
 (b) On the same set of axes,
 sketch the graphs of

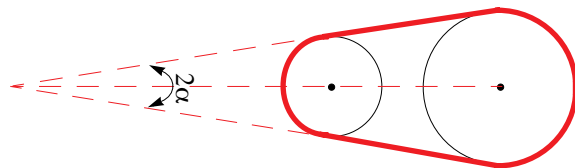

- i. $y = \frac{1}{\tan \alpha}$ ii. $y = 5.5 - \pi - \alpha$.
 (c) Hence find $\{\alpha : 1 = (5.5 - \pi - \alpha) \tan \alpha\}$, giving your answer to two d.p.

- 16.** The diagram shows a disc of radius 40 cm with parts of it painted. The smaller circle (having the same centre as the disc) has a radius of 10 cm. What area of the disc has not been painted in red?

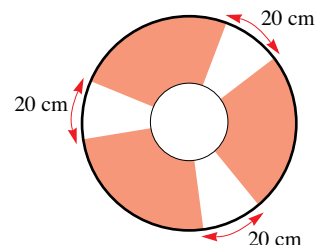

10.1 TRIGONOMETRIC RATIOS

10.1.1 THE UNIT CIRCLE

We saw in Chapter 9 that we were able to find the sine, cosine and tangent of acute angles contained within a right-angled triangle. We extended this to enable us to find the sine and cosine ratio of obtuse angles. To see why this worked, or indeed why it would work for an angle of any magnitude, we need to reconsider how angles are measured. To do this we start by making use of the unit circle and introduce some definitions.

From this point on we define the angle θ as a real number that is measured in either degrees or radians. So that, an expression such as $\sin(180^\circ - \theta)$ will imply that θ is measured in degrees as opposed to the expression $\sin(\pi^c - \theta)$ which would imply that θ is measured in radians. In both cases, it should be clear from the context of the question which one it is.

From the work in §9.7 we have the following conversions between degrees and radians and the exact value of their trigonometric ratios:

θ	$\sin \theta$	$\cos \theta$	$\tan \theta$
$30^\circ = \frac{\pi^c}{6}$	$\frac{1}{2}$	$\frac{\sqrt{3}}{2}$	$\frac{1}{\sqrt{3}}$
$45^\circ = \frac{\pi^c}{4}$	$\frac{1}{\sqrt{2}}$	$\frac{1}{\sqrt{2}}$	1
$60^\circ = \frac{\pi^c}{3}$	$\frac{\sqrt{3}}{2}$	$\frac{1}{2}$	$\sqrt{3}$
$90^\circ = \frac{\pi^c}{2}$	1	0	–

Note that $\tan 90^\circ$ is undefined. We will shortly see why this is the case.

By convention, an angle θ is measured in terms of the rotation of a ray OP from the positive direction of the x -axis, so that a rotation in the **anticlockwise** direction is described as a **positive** angle, whereas a rotation in the **clockwise** direction is described as a **negative** angle.

Let the point $P(x, y)$ be a point on the circumference of the unit circle, $x^2 + y^2 = 1$, with centre at the origin and radius 1 unit.

With OP making an angle of θ with the positive direction of the x -axis, we draw the perpendicular from P to meet the x -axis at M . This then provides the following definitions:

$$\sin \theta = \frac{MP}{OP} = \frac{\text{y-coordinate of } P}{OP} = \frac{y}{1} = y$$

$$\cos \theta = \frac{OM}{OP} = \frac{\text{x-coordinate of } P}{OP} = \frac{x}{1} = x$$

$$\tan \theta = \frac{MP}{OM} = \frac{\text{y-coordinate of } P}{\text{x-coordinate of } P} = \frac{y}{x}$$

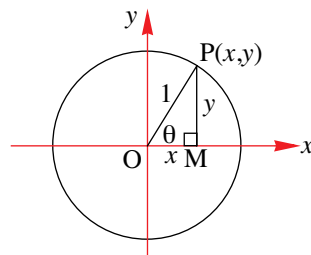

MATHEMATICS – Higher Level (Core)

Note that this means that the **y-coordinate** corresponds to the **sine of the angle** θ . That the **x-coordinate** corresponds to the **cosine of the angle** θ and that the tangent, . . . , well, for the tangent, let's revisit the unit circle, but this time we will make an addition to the diagram.

Using the existing unit circle, we draw a tangent at the point where the circle cuts the positive x -axis, Q.

Next, we extend the ray OP to meet the tangent at R.

Using similar triangles, we have that $\frac{PM}{OM} = \frac{RQ}{OQ} = \frac{RQ}{1}$.

That is, $\tan \theta = RQ$ – which means that the value of the **tangent** of the angle θ corresponds to the **y-coordinates of point R** cut off on the tangent at Q by the extended ray OP.

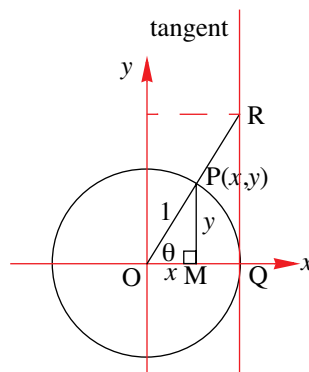

Also, it is worth noting that $\tan \theta = \frac{PM}{OM} = \frac{y}{x} = \frac{\sin \theta}{\cos \theta}$ (as long as $\cos \theta \neq 0$).

That is, $\tan \theta = \frac{\sin \theta}{\cos \theta}, \cos \theta \neq 0$

From our table of exact values, we note that $\tan 90^\circ$ was undefined. This can be observed from the above diagram. If $\theta = 90^\circ$, P lies on the y -axis, meaning that OP would be parallel to QR, and so, P would never cut the tangent, meaning that no y -value corresponding to R could ever be obtained.

Using a table of values for $\tan \theta$ on the TI-83, we see how the tangent ratio increases as θ increases to 90° and in particular how it is undefined for $\theta = 90^\circ$.

X	Y1
84	9.5144
85	11.43
86	14.301
87	19.081
88	28.636
89	57.29
90	ERROR

X=84

10.1.2 ANGLE OF ANY MAGNITUDE

From the unit circle we have seen how the trigonometric ratios of an acute angle can be obtained – i.e., for the sine ratio we read off the y -axis, for the cosine ratio, we read off the x -axis and for the tangent ratio we read off the tangent. As the point P is located in the first quadrant, then $x \geq 0$, $y \geq 0$ and $\frac{y}{x} \geq 0, x \neq 0$. Meaning that we obtain positive trigonometric ratios.

So, what if P lies in the second quadrant?

We start by drawing a diagram for such a situation:

From our diagram we see that if P lies in the second quadrant, the **y-value is still positive**, the **x-value is negative** and therefore the ratio, $\frac{y}{x}$ is **negative**.

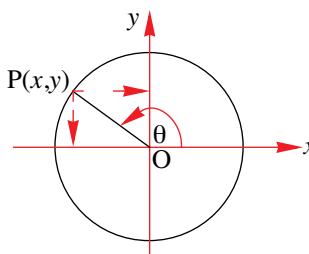

This means that, $\sin \theta > 0$, $\cos \theta < 0$ and $\tan \theta < 0$.

In a similar way, we can conclude that if $180^\circ < \theta < 270^\circ$,
i.e., the point P is in the **third quadrant**, then,

$$y\text{-value is negative} \Rightarrow \sin \theta < 0,$$

$$x\text{-value is negative} \Rightarrow \cos \theta < 0$$

and therefore the ratio $\frac{y}{x}$ -value is positive $\Rightarrow \tan \theta > 0$

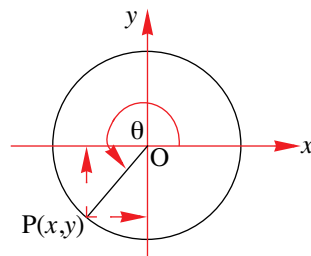

For the **fourth quadrant** we have, $270 < \theta < 360$, so that

$$y\text{-value is negative} \Rightarrow \sin \theta < 0,$$

$$x\text{-value is positive} \Rightarrow \cos \theta > 0$$

and therefore the ratio $\frac{y}{x}$ -value is negative $\Rightarrow \tan \theta < 0$

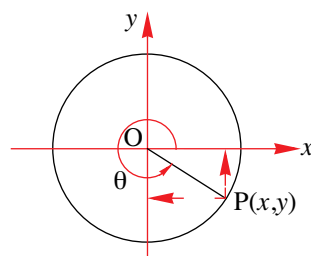

So far, so good. We now know that depending on which quadrant an angle lies in, the sign of the trigonometric ratio will be either positive or negative. In fact, we can summarise this as follows:

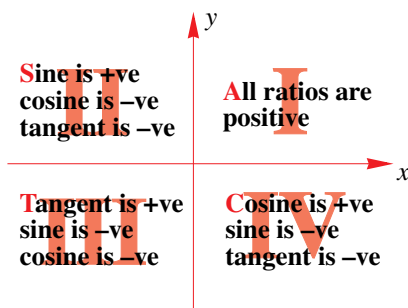

This may be usefully recalled from the following diagram, or by use of a mnemonic sentence



All Stations To City

However, knowing the sign of a trigonometric ratio reflects only half the information. We still need to determine the numerical value. We start by considering a few examples:

Consider the value of $\sin 150^\circ$. Using the unit circle we have:

By symmetry we see that the y-coordinate of Q and the

y-coordinate of P are the same and so, $\sin 150^\circ = \sin 30^\circ$.

$$\text{Therefore, } \sin 150^\circ = \frac{1}{2}$$

Note that $150^\circ = 150 \times \frac{\pi}{180} = \frac{5\pi}{6}$ and $30^\circ = \frac{\pi}{6}$, so that in

$$\text{radian form we have, } \sin \frac{5\pi}{6} = \sin \frac{\pi}{6} = \frac{1}{2}.$$

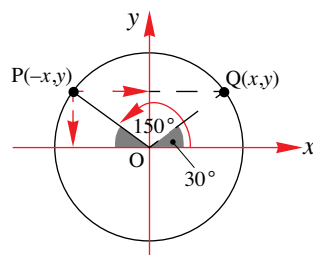

In other words, we were able to express the sine of an angle in the second quadrant in terms of the sine of an angle in the first quadrant. In particular, we have that

$$\text{If } 0^\circ < \theta < 90^\circ, \sin(180 - \theta) = \sin \theta$$

Or,

$$\text{If } 0^\circ < \theta < \frac{\pi}{2}, \sin(\pi - \theta) = \sin \theta$$

MATHEMATICS – Higher Level (Core)

Next, consider the value of $\cos 225^\circ$. Using the unit circle we have:

By symmetry we see that the x -coordinate of P has the same magnitude as the x -coordinate of Q but is of the opposite sign.

So, we have that $\cos 225^\circ = -\cos 45^\circ$.

Therefore, $\cos 225^\circ = -\frac{1}{\sqrt{2}}$.

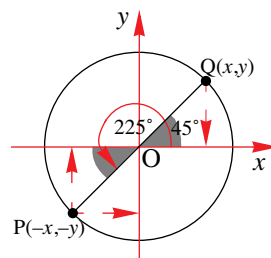

Similarly, as $225^\circ = \frac{3\pi^c}{4}$ and $45^\circ = \frac{\pi^c}{4}$, $\cos \frac{3\pi^c}{4} = -\cos \frac{\pi^c}{4} = -\frac{1}{\sqrt{2}}$.

In other words, we were able to express the cosine of an angle in the third quadrant in terms of the cosine of an angle in the first quadrant. In particular, we have that

$$\text{If } 0^\circ < \theta < 90^\circ, \cos(180 + \theta) = -\cos \theta$$

Or,

$$\text{If } 0^c < \theta < \frac{\pi^c}{2}, \cos(\pi^c + \theta) = -\cos \theta$$

As a last example we consider the value of $\tan 300^\circ$. This time we need to add a tangent to the unit circle cutting the positive x -axis:

By symmetry we see that the y -coordinate of P has the same magnitude as the y -coordinate of Q but is of the opposite sign.

So, we have that $\tan 300^\circ = -\tan 60^\circ$.

Therefore, $\tan 300^\circ = -\sqrt{3}$.

Similarly, as $300^\circ = \frac{5\pi^c}{3}$ and $60^\circ = \frac{\pi^c}{3}$, $\tan \frac{5\pi^c}{3} = -\tan \frac{\pi^c}{3} = -\sqrt{3}$.

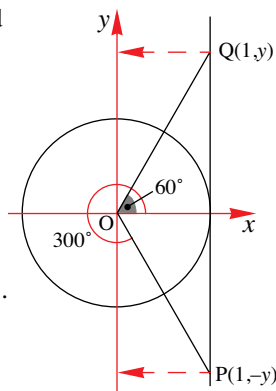

In other words, we were able to express the tangent of an angle in the fourth quadrant in terms of the tangent of an angle in the first quadrant. In particular, we have that

$$\text{If } 0^\circ < \theta < 90^\circ, \tan(360 - \theta) = -\tan \theta$$

Or,

$$\text{If } 0^c < \theta < \frac{\pi^c}{2}, \tan(2\pi^c - \theta) = -\tan \theta$$

In summary we have:

To find the sine of θ , i.e., $\sin \theta$ we read off the y -value of P.

So that, $\sin \theta = b$

To find the cosine of θ , i.e., $\cos \theta$ we read off the x -value of P.

So that, $\cos \theta = a$

To find the tangent of θ , i.e., $\tan \theta$ we read off the y^* -value of R.

So that, $\tan \theta = \frac{b}{a} = y^*$

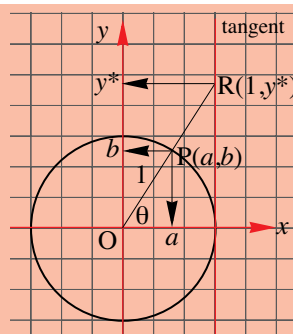

EXAMPLE 10.1

Find the exact values of

- (a)
- $\cos 120^\circ$
- (b)
- $\sin 210^\circ$
- (c)
- $\cos \frac{7\pi}{4}$
- (d)
- $\tan \frac{5\pi}{4}$

**S
o
l
u
t
i
o
n**

- (a) **Step 1:** Start by drawing the unit circle:
Step 2: Trace out an angle of 120°
Step 3: Trace out the **reference angle** in the first quadrant. In this case it is 60° .
Step 4: Use the symmetry between the reference angle and the given angle.
Step 5: State relationship and give answer;

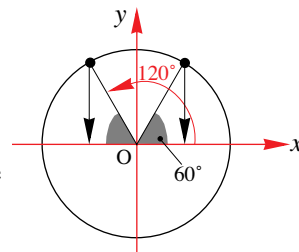

$$\cos 120^\circ = -\cos 60^\circ = -\frac{1}{2}$$

- (b) **Step 1:** Start by drawing the unit circle:
Step 2: Trace out an angle of 210°
Step 3: Trace out the **reference angle** in the first quadrant. In this case it is 30° .
Step 4: Use the symmetry between the reference angle and the given angle.
Step 5: State relationship and give answer;

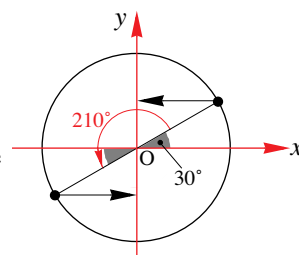

$$\sin 210^\circ = -\sin 30^\circ = -\frac{1}{2}$$

- (c) **Step 1:** Start by drawing the unit circle:
Step 2: Trace out an angle of $\frac{7\pi}{4}$ ($= 315^\circ$)
Step 3: Trace out the **reference angle** in the first quadrant. In this case it is $\frac{\pi}{4}$.
Step 4: Use the symmetry between the reference angle and the given angle.
Step 5: State relationship and give answer;

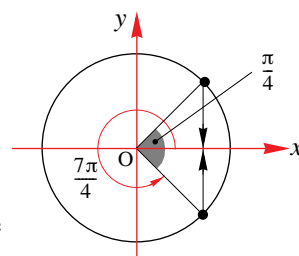

$$\cos \frac{7\pi}{4} = \cos \frac{\pi}{4} = \frac{1}{\sqrt{2}}$$

- (c) **Step 1:** Start by drawing the unit circle:
Step 2: Trace out an angle of $\frac{5\pi}{4}$ ($= 225^\circ$)
Step 3: Trace out the **reference angle** in the first quadrant. In this case it is $\frac{\pi}{4}$.
Step 4: Use the symmetry between the reference angle and the given angle.
Step 5: State relationship and give answer;

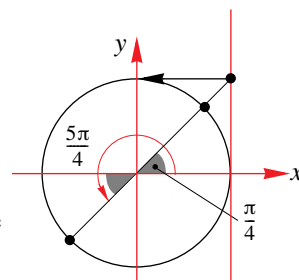

$$\tan \frac{5\pi}{4} = \tan \frac{\pi}{4} = 1$$

MATHEMATICS – Higher Level (Core)

The results we have obtained, that is, expressing trigonometric ratios of any angle in terms of trigonometric ratios of acute angles in the first quadrant (i.e., reference angles) are known as **trigonometric reduction formulae**. There are too many formulae to commit to memory, and so it is advisable to draw a unit circle and then use symmetry properties as was done in

Examples 10.1. We list a number of these formulae in the table below, where $0 < \theta < \frac{\pi}{2}$ ($= 90^\circ$).

Note: From this point on angles without the degree symbol or radian symbol will mean an angle measured in radian mode.

Quadrant	θ in degrees	θ in radians
2	$\sin(180^\circ - \theta) = \sin \theta$ $\cos(180^\circ - \theta) = -\cos \theta$ $\tan(180^\circ - \theta) = -\tan \theta$	$\sin(\pi - \theta) = \sin \theta$ $\cos(\pi - \theta) = -\cos \theta$ $\tan(\pi - \theta) = -\tan \theta$
3	$\sin(180^\circ + \theta) = -\sin \theta$ $\cos(180^\circ + \theta) = -\cos \theta$ $\tan(180^\circ + \theta) = \tan \theta$	$\sin(\pi + \theta) = -\sin \theta$ $\cos(\pi + \theta) = -\cos \theta$ $\tan(\pi + \theta) = \tan \theta$
4	$\sin(360^\circ - \theta) = -\sin \theta$ $\cos(360^\circ - \theta) = \cos \theta$ $\tan(360^\circ - \theta) = -\tan \theta$	$\sin(2\pi - \theta) = -\sin \theta$ $\cos(2\pi - \theta) = \cos \theta$ $\tan(2\pi - \theta) = -\tan \theta$

There is another set of results that is suggested by symmetry through the fourth quadrant:

Quadrant	θ in degrees or θ in radians
4	$\sin(-\theta) = -\sin \theta$ $\cos(-\theta) = \cos \theta$ $\tan(-\theta) = -\tan \theta$

There are other trigonometric reduction formulae, where $0 < \theta < \frac{\pi}{2}$ or $0 < \theta < 90^\circ$. These formulae however, are expressed in terms of their variation from the vertical axis. That is:

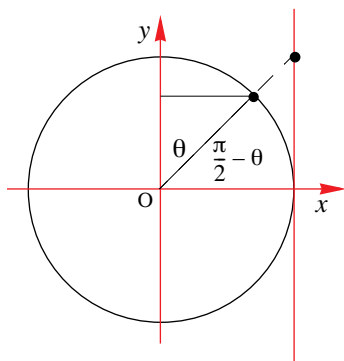

Quadrant	θ in radians or θ in degrees
1	$\sin\left(\frac{\pi}{2} - \theta\right) = \cos \theta, \quad \sin(90^\circ - \theta) = \cos \theta$ $\cos\left(\frac{\pi}{2} - \theta\right) = \sin \theta, \quad \cos(90^\circ - \theta) = \sin \theta$ $\tan\left(\frac{\pi}{2} - \theta\right) = \cot \theta, \quad \tan(90^\circ - \theta) = \cot \theta$

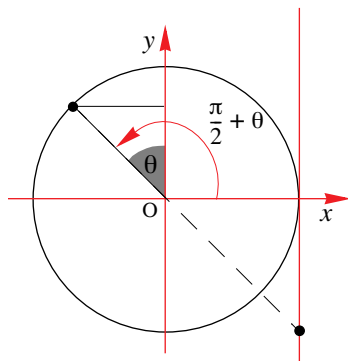

Quadrant	θ in radians	or	θ in degrees
2	$\sin\left(\frac{\pi}{2} + \theta\right) = \cos \theta$, $\sin(90^\circ + \theta) = \cos \theta$		
	$\cos\left(\frac{\pi}{2} + \theta\right) = -\sin \theta$, $\cos(90^\circ + \theta) = -\sin \theta$		
	$\tan\left(\frac{\pi}{2} + \theta\right) = -\cot \theta$, $\tan(90^\circ + \theta) = -\cot \theta$		

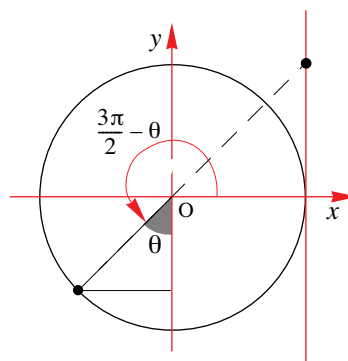

Quadrant	θ in radians	or	θ in degrees
3	$\sin\left(\frac{3\pi}{2} - \theta\right) = -\cos \theta$, $\sin(270^\circ - \theta) = -\cos \theta$		
	$\cos\left(\frac{3\pi}{2} - \theta\right) = -\sin \theta$, $\cos(270^\circ - \theta) = -\sin \theta$		
	$\tan\left(\frac{3\pi}{2} - \theta\right) = \cot \theta$, $\tan(270^\circ - \theta) = \cot \theta$		

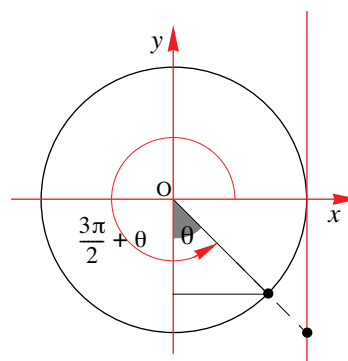

Quadrant	θ in radians	or	θ in degrees
4	$\sin\left(\frac{3\pi}{2} + \theta\right) = -\cos \theta$, $\sin(270^\circ + \theta) = -\cos \theta$		
	$\cos\left(\frac{3\pi}{2} + \theta\right) = \sin \theta$, $\cos(270^\circ + \theta) = \sin \theta$		
	$\tan\left(\frac{3\pi}{2} + \theta\right) = -\cot \theta$, $\tan(270^\circ + \theta) = -\cot \theta$		

Note the introduction of a new trigonometric ratio, $\cot \theta$. This is one of a set of three other trigonometric ratios known as the **reciprocal trigonometric ratios**, namely **cosecant**, **secant** and **cotangent** ratios. These are defined as

$$\text{cosecant ratio : } \operatorname{cosec} \theta = \frac{1}{\sin \theta}, \sin \theta \neq 0$$

$$\text{secant ratio : } \sec \theta = \frac{1}{\cos \theta}, \cos \theta \neq 0$$

$$\text{cotangent ratio : } \cot \theta = \frac{1}{\tan \theta}, \tan \theta \neq 0$$

Note then, that $\cot \theta = \frac{1}{\tan \theta} = \frac{\cos \theta}{\sin \theta}$, $\sin \theta \neq 0$

EXAMPLE 10.2

Given that $\sin \theta = 0.3$, where $0 < \theta < \frac{\pi}{2}$ find

- (a) $\sin(\pi + \theta)$ (b) $\sin(2\pi - \theta)$ (c) $\cos\left(\frac{\pi}{2} - \theta\right)$

S
O
L
V
E
D
I
N
G

- (a) From the reduction formulae, we have that $\sin(\pi + \theta) = -\sin \theta$.
Therefore, $\sin(\pi + \theta) = -0.3$.
- (b) From the reduction formulae, we have that $\sin(2\pi - \theta) = -\sin \theta$.
Therefore, $\sin(\pi + \theta) = -0.3$.
- (c) From the reduction formulae, we have that $\cos\left(\frac{\pi}{2} - \theta\right) = \sin \theta$.
Therefore, $\cos\left(\frac{\pi}{2} - \theta\right) = 0.3$.

EXAMPLE 10.3

Given that $\cos \theta = k$ and $0 < \theta < \frac{\pi}{2}$ find

- (a) $\cos(\pi + \theta)$ (b) $\cos(2\pi - \theta)$ (c) $\cos\left(\frac{\pi}{2} + \theta\right)$

S
O
L
V
E
D
I
N
G

- (a) $\cos(\pi + \theta) = -\cos \theta \therefore \cos(\pi + \theta) = -k$.
- (b) $\cos(2\pi - \theta) = \cos \theta \therefore \cos(2\pi - \theta) = k$.
- (c) $\cos\left(\frac{\pi}{2} + \theta\right) = -\sin \theta$. However, we only have a value for $\cos \theta$.

To determine the value of $\sin \theta$ that corresponds to $\cos \theta = k$ we make use of a right-angled triangle where $\cos \theta = k$.

Construct a right-angled triangle ABC, where $\angle BAC = \theta$

so that $AC = k$ and $AB = 1$ (i.e., $\cos \theta = \frac{AC}{AB} = \frac{k}{1} = k$).

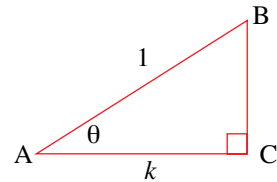

Then, from Pythagoras's theorem, we have

$$1^2 = k^2 + BC^2 \Leftrightarrow BC = \pm\sqrt{1-k^2}$$

Therefore, as $\sin \theta = \frac{BC}{AB} \Rightarrow \sin \theta = \frac{\pm\sqrt{1-k^2}}{1} = \pm\sqrt{1-k^2}$.

However, as $0 < \theta < \frac{\pi}{2}$, then θ is in the first quadrant and so, $\sin \theta > 0 \therefore \sin \theta = \sqrt{1-k^2}$.

Now that we have the value of $\sin \theta$ we can complete the question:

$$\sin\left(\frac{\pi}{2} + \theta\right) = -\sin \theta \therefore \sin\left(\frac{\pi}{2} + \theta\right) = -\sqrt{1-k^2}$$

Part (c) in Example 10.3 shows a useful approach, i.e., constructing a right-angled triangle to help in determining the trigonometric ratio of one of the six trig ratios based on any one of the remaining five trig ratios.

EXAMPLE 10.4

Given that $\sin \theta = k$ and $0 < \theta < \frac{\pi}{2}$ find

- (a) $\tan \theta$ (b) $\operatorname{cosec} \theta$ (c) $\sec(\pi + \theta)$

S
o
l
u
t
i
o
n

As we are looking for trigonometric ratios based solely on that of the sine ratio, we start by constructing a right-angled triangle satisfying the relationship, $\sin \theta = k$

In this case, as $\sin \theta = \frac{\text{opp}}{\text{hyp}} = k \Rightarrow \frac{\text{opp}}{\text{hyp}} = \frac{BC}{AB} = \frac{k}{1}$

(using the simplest ratio).

Using Pythagoras's theorem, we have

$$1^2 = k^2 + AC^2 \Leftrightarrow AC = \pm\sqrt{1-k^2}$$

(a) $\tan \theta = \frac{\text{opp}}{\text{adj}} = \frac{k}{\pm\sqrt{1-k^2}}$.

However, as $0 < \theta < \frac{\pi}{2}$, $\tan \theta > 0 \therefore \tan \theta = \frac{k}{\sqrt{1-k^2}}$.

(b) $\operatorname{cosec} \theta = \frac{1}{\sin \theta} \therefore \operatorname{cosec} \theta = \frac{1}{k}$.

(c) $\sec(\pi + \theta) = \frac{1}{\cos(\pi + \theta)} = -\frac{1}{\cos \theta}$.

But, $\cos \theta = \frac{\text{adj}}{\text{hyp}} = \frac{\pm\sqrt{1-k^2}}{1} = \pm\sqrt{1-k^2}$.

However, as $0 < \theta < \frac{\pi}{2}$, $\cos \theta > 0 \therefore \cos \theta = \sqrt{1-k^2}$.

Therefore, $\sec(\pi + \theta) = -\frac{1}{\sqrt{1-k^2}}$.

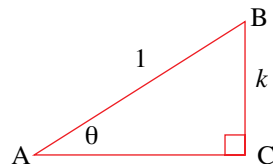
EXAMPLE 10.5

Find the exact values of

- (a) $\sec 45^\circ$ (b) $\operatorname{cosec} 150^\circ$ (c) $\cot \frac{11\pi}{6}$ (d) $\sec 0$

S
o
l
u
t
i
o
n

(a) $\sec 45^\circ = \frac{1}{\cos 45^\circ} = \frac{1}{\left(\frac{1}{\sqrt{2}}\right)} = \sqrt{2}$

(b) $\operatorname{cosec} 150^\circ = \frac{1}{\sin 150^\circ} = \frac{1}{\sin 30^\circ} = \frac{1}{\left(\frac{1}{2}\right)} = 2$

$$(c) \quad \cot \frac{11\pi}{6} = \frac{1}{\tan\left(\frac{11\pi}{6}\right)} = \frac{1}{\tan\left(-\frac{\pi}{6}\right)} = \frac{1}{-\tan\frac{\pi}{6}} = \frac{1}{-\left(\frac{1}{\sqrt{3}}\right)} = -\sqrt{3}$$

$$(c) \quad \sec 0 = \frac{1}{\cos 0} = \frac{1}{1} = 1$$

EXAMPLE 10.6

Find (a) $\sin \theta = \frac{1}{2}, 0^\circ < \theta < 360^\circ$

(b) $\tan \theta = -\sqrt{3}, 0 < \theta < 2\pi$

(c) $\sec \theta = 1, 0 < \theta < 2\pi$

Solution

(a) This time we are searching for those values of θ for which $\sin \theta = \frac{1}{2}$.

To do this we make use of the unit circle:

From the unit circle, we draw a horizontal chord passing the y -axis at $y = 0.5$.

Then, in the first quadrant, from our table of exact values we have that $\theta = 30^\circ$.

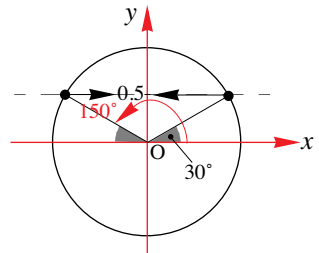

However, by symmetry, we also have that $\sin 150^\circ = \frac{1}{2}$.

Therefore, $\sin \theta = \frac{1}{2}, 0^\circ < \theta < 360^\circ$ if $\theta = 30^\circ$ or 150° .

(b) This time we are searching for those values of θ for which $\tan \theta = -\sqrt{3}$.

From the unit circle, we extend the ray OP so that it cuts the tangent line at R .

Using the exact values, we have $\tan\left(\pi - \frac{\pi}{3}\right) = \tan \frac{2\pi}{3} = -\sqrt{3}$

(as our first value).

And, by symmetry, we also have that $\tan\left(2\pi - \frac{\pi}{3}\right) = -\sqrt{3}$.

Therefore, $\theta = \frac{2\pi}{3}$ or $\theta = \frac{5\pi}{3}$.

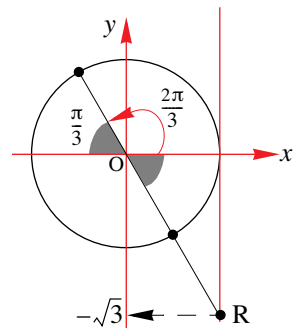

(c) $\sec \theta = 1 \Leftrightarrow \frac{1}{\cos \theta} = 1 \Leftrightarrow \cos \theta = 1$

Therefore, $\theta = 0$ or $\theta = 2\pi$

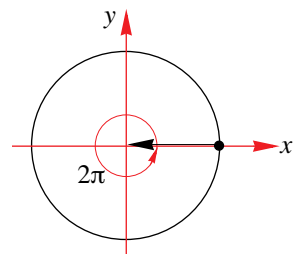

EXAMPLE 10.7

Simplify

$$(a) \frac{\sin(\pi + \theta)}{\cos(2\pi - \theta)} \quad (b) \frac{\sin\left(\frac{\pi}{2} + \theta\right) \cos\left(\frac{\pi}{2} - \theta\right)}{\cos(\pi + \theta)}, \text{ where } 0 < \theta < \frac{\pi}{2}.$$

S
o
l
u
t
i
o
n

$$(a) \frac{\sin(\pi + \theta)}{\cos(2\pi - \theta)} = \frac{-\sin \theta}{\cos \theta} \\ = -\tan \theta$$

$$(b) \frac{\sin\left(\frac{\pi}{2} + \theta\right) \cos\left(\frac{\pi}{2} - \theta\right)}{\cos(\pi + \theta)} = \frac{\cos \theta \sin \theta}{-\cos \theta} \\ = -\sin \theta$$

EXERCISES 10.1**1.** Convert the following angles to degrees.

$$(a) \frac{2\pi}{3} \quad (b) \frac{3\pi}{5} \quad (c) \frac{12\pi}{10} \quad (d) \frac{5\pi}{18}$$

2. Convert the following angles to radians.

$$(a) 180^\circ \quad (b) 270^\circ \quad (c) 140^\circ \quad (d) 320^\circ$$

3. Find the exact value of

$$(a) \sin 120^\circ \quad (b) \cos 120^\circ \quad (c) \tan 120^\circ \quad (d) \sec 120^\circ \\ (e) \sin 210^\circ \quad (f) \cos 210^\circ \quad (g) \tan 210^\circ \quad (h) \cot 210^\circ \\ (i) \sin 225^\circ \quad (j) \cos 225^\circ \quad (k) \tan 225^\circ \quad (l) \operatorname{cosec} 225^\circ \\ (m) \sin 315^\circ \quad (n) \cos 315^\circ \quad (o) \tan 315^\circ \quad (p) \sec 315^\circ \\ (q) \sin 360^\circ \quad (r) \cos 360^\circ \quad (s) \tan 360^\circ \quad (t) \operatorname{cosec} 360^\circ$$

4. Find the exact value of

$$(a) \sin \pi \quad (b) \cos \pi \quad (c) \tan \pi \quad (d) \sec \pi \\ (e) \sin \frac{3\pi}{4} \quad (f) \cos \frac{3\pi}{4} \quad (g) \tan \frac{3\pi}{4} \quad (h) \operatorname{cosec} \frac{3\pi}{4} \\ (i) \sin \frac{7\pi}{6} \quad (j) \cos \frac{7\pi}{6} \quad (k) \tan \frac{7\pi}{6} \quad (l) \cot \frac{7\pi}{6} \\ (m) \sin \frac{5\pi}{3} \quad (n) \cos \frac{5\pi}{3} \quad (o) \tan \frac{5\pi}{3} \quad (p) \sec \frac{5\pi}{3} \\ (q) \sin \frac{7\pi}{4} \quad (r) \cos \frac{7\pi}{4} \quad (s) \tan \frac{7\pi}{4} \quad (t) \operatorname{cosec} \frac{7\pi}{4}$$

MATHEMATICS – Higher Level (Core)

5. Find the exact value of

- (a) $\sin(-210^\circ)$ (b) $\cos(-30^\circ)$ (c) $\tan(-135^\circ)$ (d) $\cos(-420^\circ)$
 (e) $\cot(-60^\circ)$ (f) $\sin(-150^\circ)$ (g) $\sec(-135^\circ)$ (h) $\operatorname{cosec}(-120^\circ)$

6. Find the exact value of

- (a) $\sin\left(-\frac{\pi}{6}\right)$ (b) $\cos\left(-\frac{3\pi}{4}\right)$ (c) $\tan\left(-\frac{2\pi}{3}\right)$ (d) $\sec\left(-\frac{4\pi}{3}\right)$
 (e) $\cot\left(-\frac{3\pi}{4}\right)$ (f) $\sin\left(-\frac{7\pi}{6}\right)$ (g) $\cot\left(-\frac{\pi}{3}\right)$ (h) $\cos\left(-\frac{7\pi}{6}\right)$
 (i) $\operatorname{cosec}\left(-\frac{2\pi}{3}\right)$ (j) $\tan\left(-\frac{11\pi}{6}\right)$ (k) $\sec\left(-\frac{13\pi}{6}\right)$ (l) $\sin\left(-\frac{7\pi}{3}\right)$

7. Find the coordinates of the point P on the following unit circles.

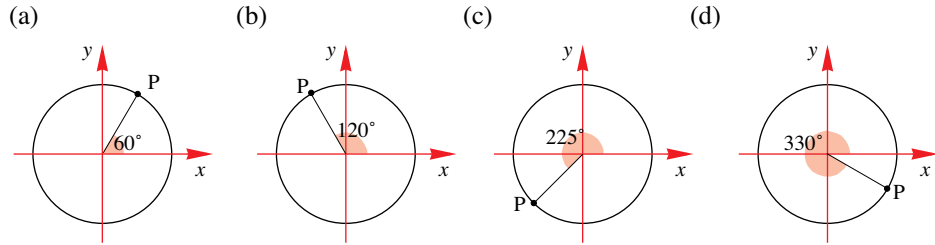

8. Find the exact value of

- (a) $\sin\frac{11\pi}{6}\cos\frac{5\pi}{6} - \sin\frac{5\pi}{6}\cos\frac{11\pi}{6}$ (b) $2\sin\frac{\pi}{6}\cos\frac{\pi}{6}$
 (c) $\frac{\tan\frac{\pi}{3} - \tan\frac{\pi}{6}}{1 + \tan\frac{\pi}{3}\tan\frac{\pi}{6}}$ (d) $\cos\frac{\pi}{4}\cos\frac{\pi}{3} + \sin\frac{\pi}{4}\sin\frac{\pi}{3}$

9. Show that the following relationships are true

- (a) $\sin 2\theta = 2\sin\theta\cos\theta$, where $\theta = \frac{\pi}{3}$
 (b) $\cos 2\theta = 2\cos^2\theta - 1$, where $\theta = \frac{\pi}{6}$.
 (c) $\tan 2\theta = \frac{2\tan\theta}{1 - \tan^2\theta}$, where $\theta = \frac{2\pi}{3}$.
 (d) $\sin(\theta - \phi) = \sin\theta\cos\phi - \sin\phi\cos\theta$, where $\theta = \frac{2\pi}{3}$ and $\phi = -\frac{\pi}{3}$.

10. Given that $\sin\theta = \frac{2}{3}$ and $0 < \theta < \frac{\pi}{2}$ find

- (a) $\sin(\pi + \theta)$ (b) $\sin(2\pi - \theta)$ (c) $\cos\left(\frac{\pi}{2} + \theta\right)$

11. Given that $\cos \theta = \frac{2}{5}$ and $0 < \theta < \frac{\pi}{2}$ find

(a) $\cos(\pi - \theta)$ (b) $\sec \theta$ (c) $\sin\left(\frac{\pi}{2} - \theta\right)$

12. Given that $\tan \theta = k$ and $0 < \theta < \frac{\pi}{2}$ find

(a) $\tan(\pi + \theta)$ (b) $\tan\left(\frac{\pi}{2} + \theta\right)$ (c) $\tan(-\theta)$

13. Given that $\sin \theta = \frac{2}{3}$ and $0 < \theta < \frac{\pi}{2}$ find

(a) $\cos \theta$ (b) $\sec \theta$ (c) $\cos(\pi + \theta)$

14. Given that $\cos \theta = -\frac{4}{5}$ and $\pi < \theta < \frac{3\pi}{2}$ find

(a) $\sin \theta$ (b) $\tan \theta$ (c) $\cos(\pi + \theta)$

15. Given that $\tan \theta = -\frac{4}{3}$ and $\frac{\pi}{2} < \theta < \pi$ find

(a) $\sin \theta$ (b) $\tan\left(\frac{\pi}{2} + \theta\right)$ (c) $\sec \theta$

16. Given that $\cos \theta = k$ and $\frac{3\pi}{2} < \theta < 2\pi$ find

(a) $\cos(\pi - \theta)$ (b) $\sin \theta$ (c) $\cot \theta$

17. Given that $\sin \theta = -k$ and $\pi < \theta < \frac{3\pi}{2}$ find

(a) $\cos \theta$ (b) $\tan \theta$ (c) $\operatorname{cosec}\left(\frac{\pi}{2} + \theta\right)$

18. Simplify the following

(a) $\frac{\sin(\pi - \theta)\cos\left(\frac{\pi}{2} + \theta\right)}{\sin(\pi + \theta)}$ (b) $\frac{\sin\left(\frac{\pi}{2} + \theta\right)\cos\left(\frac{\pi}{2} - \theta\right)}{\sin^2 \theta}$ (c) $\frac{\sin\left(\frac{\pi}{2} - \theta\right)}{\cos \theta}$
 (d) $\tan(\pi + \theta)\cot \theta$ (e) $\cos(2\pi - \theta)\operatorname{cosec} \theta$ (f) $\frac{\sec \theta}{\operatorname{cosec} \theta}$

19. If $0 \leq \theta \leq 2\pi$, find all values of x such that

(a) $\sin x = \frac{\sqrt{3}}{2}$ (b) $\cos x = \frac{1}{2}$ (c) $\tan x = \sqrt{3}$
 (d) $\cos x = -\frac{\sqrt{3}}{2}$ (e) $\tan x = -\frac{1}{\sqrt{3}}$ (f) $\sin x = -\frac{1}{2}$

10.2 TRIGONOMETRIC IDENTITIES

10.2.1 THE FUNDAMENTAL IDENTITY

We have seen a number of important relationships between trigonometric ratios. Relationships that are true for all values of θ are known as **identities**. To signal an identity (as opposed to an equation) the **equivalence** symbol is used, i.e., ‘ \equiv ’.

For example, we can write $(x + 1)^2 \equiv x^2 + 2x + 1$, as this statement is true for all values of x . However, we would have to write $(x + 1)^2 = x + 1$, as this relationship is only true for some values of x (which need to be determined).

One trigonometric identity is based on the unit circle

Consider the point $P(x, y)$ on the unit circle,

$$x^2 + y^2 = 1 \quad (1)$$

From the previous section, we know that

$$x = \cos \theta \quad (2)$$

$$y = \sin \theta \quad (3)$$

Substituting (2) and (3) into (1) we have: $(\cos \theta)^2 + (\sin \theta)^2 = 1$
or

$$\sin^2 \theta + \cos^2 \theta = 1 \quad (4)$$

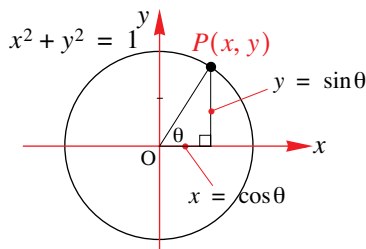

This is known as the fundamental trigonometric identity. Note that we have not used the identity symbol, i.e., we have not written $\sin^2 \theta + \cos^2 \theta \equiv 1$. This is because more often than not, it will be ‘obvious’ from the setting as to whether a relationship is an identity or an equation. And so, there is a tendency to forgo the formal use of the identity statement and restrict ourselves to the equality statement.

By rearranging the identity we have that $\sin^2 \theta = 1 - \cos^2 \theta$ and $\cos^2 \theta = 1 - \sin^2 \theta$. Similarly we obtain the following two new identities:

$$\begin{aligned} \text{Divide both sides of (4) by } \cos^2 \theta: \frac{\sin^2 \theta + \cos^2 \theta}{\cos^2 \theta} &= \frac{1}{\cos^2 \theta} \Leftrightarrow \frac{\sin^2 \theta}{\cos^2 \theta} + \frac{\cos^2 \theta}{\cos^2 \theta} = \frac{1}{\cos^2 \theta} \\ &\Leftrightarrow \tan^2 \theta + 1 = \sec^2 \theta \quad (5) \end{aligned}$$

$$\begin{aligned} \text{Divide both sides of (4) by } \sin^2 \theta: \frac{\sin^2 \theta + \cos^2 \theta}{\sin^2 \theta} &= \frac{1}{\sin^2 \theta} \Leftrightarrow \frac{\sin^2 \theta}{\sin^2 \theta} + \frac{\cos^2 \theta}{\sin^2 \theta} = \frac{1}{\sin^2 \theta} \\ &\Leftrightarrow 1 + \cot^2 \theta = \operatorname{cosec}^2 \theta \quad (6) \end{aligned}$$

In summary we have:

$$\begin{aligned} \sin^2 \theta + \cos^2 \theta &= 1 \\ \tan^2 \theta + 1 &= \sec^2 \theta \\ 1 + \cot^2 \theta &= \operatorname{cosec}^2 \theta \end{aligned}$$

EXAMPLE 10.8

If $\cos \theta = -\frac{3}{5}$, where $\pi \leq \theta \leq \frac{3\pi}{2}$, find (a) $\sin \theta$ (b) $\tan \theta$

Solution

- (a) Although we solved problems like this in §10.1 by making use of a right-angled triangle, we now solve this question by making use of the trigonometric identities we have just developed.

$$\text{From } \sin^2 \theta + \cos^2 \theta = 1 \text{ we have } \sin^2 \theta + \left(-\frac{3}{5}\right)^2 = 1 \Leftrightarrow \sin^2 \theta + \frac{9}{25} = 1$$

$$\Leftrightarrow \sin^2 \theta = \frac{16}{25}$$

$$\therefore \sin \theta = \pm \frac{4}{5}$$

Now, as $\pi \leq \theta \leq \frac{3\pi}{2}$, this means the angle is in the third quadrant, where the sine value is

negative. Therefore, we have that $\sin \theta = -\frac{4}{5}$

- (b) Using the identity $\tan \theta = \frac{\sin \theta}{\cos \theta}$, we have $\tan \theta = \frac{(-4/5)}{(-3/5)} = \frac{4}{3}$.

EXAMPLE 10.9

If $\tan \theta = \frac{5}{12}$, where $\pi \leq \theta \leq \frac{3\pi}{2}$, find (a) $\cos \theta$ (b) $\operatorname{cosec} \theta$

Solution

- (a) From the identity $\tan^2 \theta + 1 = \sec^2 \theta$ we have $\left(\frac{5}{12}\right)^2 + 1 = \sec^2 \theta \Leftrightarrow \sec^2 \theta = \frac{25}{144} + 1$

$$\therefore \sec^2 \theta = \frac{169}{144}$$

$$\therefore \sec \theta = \pm \frac{13}{12}$$

Therefore, as $\cos \theta = \frac{1}{\sec \theta} \Rightarrow \cos \theta = \pm \frac{12}{13}$. However, $\pi \leq \theta \leq \frac{3\pi}{2}$, meaning that θ is in the

third quadrant. And so, the cosine is negative. That is, $\cos \theta = -\frac{12}{13}$.

- (b) Now, $\operatorname{cosec} \theta = \frac{1}{\sin \theta}$, but, $\tan \theta = \frac{\sin \theta}{\cos \theta} \Leftrightarrow \sin \theta = \tan \theta \cos \theta \therefore \sin \theta = \frac{5}{12} \times -\frac{12}{13}$

$$= -\frac{5}{13}$$

Therefore, $\operatorname{cosec} \theta = \frac{1}{(-5/13)} = -\frac{13}{5}$.

EXAMPLE 10.10

Simplify the following expressions

(a) $\cos \theta + \tan \theta \sin \theta$ (b) $\frac{\cos \theta}{1 + \sin \theta} - \frac{1 - \sin \theta}{\cos \theta}$

S
o
l
u
t
i
o
n

$$\begin{aligned} \text{(a)} \quad \cos \theta + \tan \theta \sin \theta &= \cos \theta + \frac{\sin \theta}{\cos \theta} \sin \theta \\ &= \cos \theta + \frac{\sin^2 \theta}{\cos \theta} \\ &= \frac{\cos^2 \theta + \sin^2 \theta}{\cos \theta} \\ &= \frac{1}{\cos \theta} \\ &= \sec \theta \end{aligned}$$

$$\begin{aligned} \text{(b)} \quad \frac{\cos \theta}{1 + \sin \theta} - \frac{1 - \sin \theta}{\cos \theta} &= \frac{\cos^2 \theta}{(1 + \sin \theta) \cos \theta} - \frac{(1 - \sin \theta)(1 + \sin \theta)}{(1 + \sin \theta) \cos \theta} \\ &= \frac{\cos^2 \theta}{(1 + \sin \theta) \cos \theta} - \frac{1 - \sin^2 \theta}{(1 + \sin \theta) \cos \theta} \\ &= \frac{\cos^2 \theta - 1 + \sin^2 \theta}{(1 + \sin \theta) \cos \theta} \\ &= \frac{(\cos^2 \theta + \sin^2 \theta) - 1}{(1 + \sin \theta) \cos \theta} \\ &= \frac{1 - 1}{(1 + \sin \theta) \cos \theta} \\ &= 0 \end{aligned}$$

EXAMPLE 10.11

Show that $\frac{1 - 2\cos^2 \theta}{\sin \theta \cos \theta} = \tan \theta - \cot \theta$.

S
o
l
u
t
i
o
n

$$\begin{aligned} \text{R.H.S} &= \tan \theta - \cot \theta \\ &= \frac{\sin \theta}{\cos \theta} - \frac{\cos \theta}{\sin \theta} \\ &= \frac{\sin^2 \theta - \cos^2 \theta}{\sin \theta \cos \theta} \\ &= \frac{(1 - \cos^2 \theta) - \cos^2 \theta}{\sin \theta \cos \theta} \\ &= \frac{1 - 2\cos^2 \theta}{\sin \theta \cos \theta} \\ &= \text{L.H.S} \end{aligned}$$

EXERCISES 10.2.1

1. Prove the identity

(a) $\sin\theta + \cot\theta\cos\theta = \operatorname{cosec}\theta$

(b) $\frac{\sin\theta}{1 + \cos\theta} + \frac{1 + \cos\theta}{\sin\theta} = 2\operatorname{cosec}\theta$

(c) $\frac{\sin^2\theta}{1 - \cos\theta} = 1 + \cos\theta$

(d) $3\cos^2x - 2 = 1 - 3\sin^2x$

(e) $\tan^2x\cos^2x + \cot^2x\sin^2x = 1$

(f) $\sec\theta - \sec\theta\sin^2\theta = \cos\theta$

(g) $\sin^2\theta(1 + \cot^2\theta) - 1 = 0$

(h) $\frac{1}{1 - \sin\phi} + \frac{1}{1 + \sin\phi} = 2\sec^2\phi$

(i) $\frac{\cos\theta}{1 + \sin\theta} + \tan\theta = \sec\theta$

(j) $\frac{1 - \sin\theta}{\cos\theta} = \frac{\cos\theta}{1 + \sin\theta}$

(k) $\frac{1}{\sec x + \tan x} = \sec x - \tan x$

(l) $\sin x + \frac{\cos^2 x}{1 + \sin x} = 1$

(m) $\frac{\sec\phi + \operatorname{cosec}\phi}{\tan\phi + \cot\phi} = \sin\phi + \cos\phi$

(n) $\frac{\sin x + 1}{\cos x} = \frac{\sin x - \cos x + 1}{\sin x + \cos x - 1}$

(o) $\tan x + \sec x = \frac{\tan x + \sec x - 1}{\tan x - \sec x + 1}$

2. Prove the following

(a) $(\sin x + \cos x)^2 + (\sin x - \cos x)^2 = 2$

(b) $\sec^2\theta\operatorname{cosec}^2\theta = \sec^2\theta + \operatorname{cosec}^2\theta$

(c) $\sin^4x - \cos^4x = (\sin x + \cos x)(\sin x - \cos x)$

(d) $\sec^4x - \sec^2x = \tan^4x + \tan^2x$

(e) $\frac{\sin^3x + \cos^3x}{\sin x + \cos x} = 1 - \sin x \cos x$

(f) $(\cot x - \operatorname{cosec} x)^2 = \frac{\sec x - 1}{\sec x + 1}$

(g) $(2b\sin x \cos x)^2 + b^2(\cos^2x - \sin^2x)^2 = b^2$

3. Eliminate θ from each of the following pairs

(a) $x = k\sin\theta, y = k\cos\theta$

(b) $x = b\sin\theta, y = a\cos\theta$

(c) $x = 1 + \sin\theta, y = 2 - \cos\theta$

(d) $x = 1 - b\sin\theta, y = 2 + a\cos\theta$

(e) $x = \sin\theta + 2\cos\theta, y = \sin\theta - 2\cos\theta$

4. (a) If $\tan\theta = \frac{3}{4}, \pi \leq \theta \leq \frac{3\pi}{2}$, find i. $\cos\theta$ ii. $\operatorname{cosec}\theta$

(b) If $\sin\theta = -\frac{3}{4}, \frac{3\pi}{2} \leq \theta \leq 2\pi$, find i. $\sec\theta$ ii. $\cot\theta$

5. Solve the following, where $0 \leq \theta \leq 2\pi$

(a) $4\sin\theta = 3\operatorname{cosec}\theta$

(b) $2\cos^2\theta + \sin\theta - 1 = 0$

(c) $2 - \sin\theta = 2\cos^2\theta$

(d) $2\sin^2\theta = 2 + 3\cos\theta$

MATHEMATICS – Higher Level (Core)

- 6.** Prove $\sin^2x(1 + n\cot^2x) + \cos^2x(1 + m\tan^2x) = \sin^2x(n + \cot^2x) + \cos^2x(m + \tan^2x)$.
- 7.** If $k\sec\phi = m\tan\phi$, prove that $\sec\phi\tan\phi = \frac{mk}{m^2 - k^2}$.
- 8.** If $x = k\sec^2\phi + m\tan^2\phi$ and $y = l\sec^2\phi + n\tan^2\phi$, prove that $\frac{x-k}{k+m} = \frac{y-l}{l+n}$.
- 9.** Given that $\tan\theta = \frac{2a}{a^2-1}$, $0 < \theta < \frac{\pi}{2}$, find (a) $\sin\theta$ (b) $\cos\theta$
- 10.** (a) If $\sin x + \cos x = 1$, find the values of
i. $\sin^3x + \cos^3x$ ii. $\sin^4x + \cos^4x$
(b) Hence, deduce the value of $\sin^kx + \cos^kx$, where k is a positive integer.
- 11.** If $\tan\phi = -\frac{1}{\sqrt{x^2-1}}$, $\frac{\pi}{2} < \phi < \pi$, find, in terms of x ,
(a) $\sin\phi + \cos\phi$ (b) $\sin\phi - \cos\phi$ (c) $\sin^4\phi - \cos^4\phi$
- 12.** Find (a) the maximum value of (b) the minimum value of
i. $\cos^2\theta + 5$ ii. $\frac{5}{3\sin^2\theta + 2}$ iii. $2\cos^2\theta + \sin\theta - 1$
- 13.** (a) Given that $b\sin\phi = 1$ and $b\cos\phi = \sqrt{3}$, find b .
(b) Hence, find all values of ϕ that satisfy the relationship described in (a).
- 14.** Find (a) the maximum value of (b) the minimum value of
i. $5^{3\sin\theta - 1}$ ii. $3^{1-2\cos\theta}$
- 15.** Given that $\sin\theta\cos\theta = k$, find (a) $(\sin\theta + \cos\theta)^2$, $\sin\theta + \cos\theta > 0$.
(b) $\sin^3\theta + \cos^3\theta$, $\sin\theta + \cos\theta > 0$.
- 16.** (a) Given that $\sin\phi = \frac{1-a}{1+a}$, $0 < \phi < \frac{\pi}{2}$, find $\tan\phi$.
(b) Given that $\sin\phi = 1-a$, $\frac{\pi}{2} < \phi < \pi$, find i. $2 - \cos\phi$
ii. $\cot\phi$
- 17.** Find
(a) the value(s) of $\cos x$, where $\cot x = 4(\operatorname{cosec}x - \tan x)$, $0 < x < \pi$.
(b) the values of $\sin x$, where $3\cos x = 2 + \frac{1}{\cos x}$, $0 \leq x \leq 2\pi$.
- 18.** Given that $\sin 2x = 2\sin x\cos x$, find all values of x , such that $2\sin 2x = \tan x$, $0 \leq x \leq \pi$.

10.2.2 COMPOUND ANGLE IDENTITIES

As we have seen in the previous section, there are numerous trigonometric identities. However, they were all derived from the fundamental identities. In this section we develop some more fundamental identities (which will lead us to more identities). This set of fundamental identities are known as compound angle identities. That is, identities that involve the sine, cosine and tangent of the sum and difference of two angles.

We start with the sine of the sum of two angles, $\sin(\alpha + \beta)$:

A commonly given proof of these identities is again only valid for acute angles:

In the figure, $\angle AOE = \alpha + \beta$. The construction lines are drawn with the right angles indicated. Since $\angle DCO = \alpha$ (alternate angles) and $\angle DCE = 90^\circ - \alpha$, it follows that $\angle AOE = \alpha$. Therefore, we have,

$$\begin{aligned}\sin(\alpha + \beta) &= \sin AOE = \frac{AE}{OE} \\ &= \frac{AD + DE}{OE} \\ &= \frac{AD}{OE} + \frac{DE}{OE} \\ &= \frac{BC}{OE} + \frac{DE}{OE} \\ &= \frac{BC}{OC} \times \frac{OC}{OE} + \frac{DE}{EC} \times \frac{EC}{OE} \\ &= \sin \alpha \times \cos \beta + \cos \alpha \times \sin \beta\end{aligned}$$

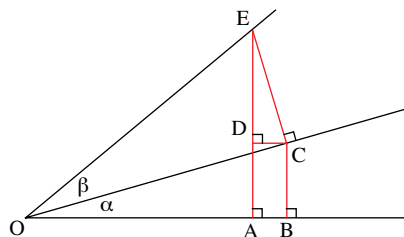

It is now possible to prove the difference formula, replacing β by $-\beta$ we have

$$\begin{aligned}\sin(\alpha - \beta) &= \sin(\alpha + (-\beta)) \\ &= \sin \alpha \cos(-\beta) + \cos \alpha \sin(-\beta) \quad (\cos(-\beta) = \cos \beta \text{ and } \sin(-\beta) = -\sin \beta) \\ &= \sin \alpha \cos \beta - \cos \alpha \sin \beta\end{aligned}$$

And so we have the addition and difference identities for sine:

$$\begin{aligned}\sin(\alpha + \beta) &= \sin \alpha \cos \beta + \cos \alpha \sin \beta \\ \sin(\alpha - \beta) &= \sin \alpha \cos \beta - \cos \alpha \sin \beta\end{aligned}$$

A similar identity can be derived for the cosine function (using the same diagram):

$$\begin{aligned}\cos(\alpha + \beta) &= \frac{OA}{OE} = \frac{OB - AB}{OE} \\ &= \frac{OB}{OE} - \frac{AB}{OE} \\ &= \frac{OB}{OE} - \frac{CD}{OE} \\ &= \frac{OB}{OC} \times \frac{OC}{OE} - \frac{CD}{EC} \times \frac{EC}{OE} \\ &= \cos \alpha \cos \beta - \sin \alpha \sin \beta\end{aligned}$$

Similarly, from this and replacing β by $-\beta$ we have that $\cos(\alpha - \beta) = \cos \alpha \cos \beta + \sin \alpha \sin \beta$

MATHEMATICS – Higher Level (Core)

And so we have the addition and difference identities for cosine:

$$\begin{aligned}\cos(\alpha + \beta) &= \cos\alpha\cos\beta - \sin\alpha\sin\beta \\ \cos(\alpha - \beta) &= \cos\alpha\cos\beta + \sin\alpha\sin\beta\end{aligned}$$

Also, the tangent addition identity can be proved as follows:

$$\begin{aligned}\tan(\alpha + \beta) &= \frac{\sin(\alpha + \beta)}{\cos(\alpha + \beta)} \\ &= \frac{\sin\alpha\cos\beta + \cos\alpha\sin\beta}{\cos\alpha\cos\beta - \sin\alpha\sin\beta} \\ &= \frac{\sin\alpha\cos\beta + \cos\alpha\sin\beta}{\cos\alpha\cos\beta} \text{ using } \frac{\sin\theta}{\cos\theta} = \tan\theta \\ &= \frac{\cos\alpha\cos\beta - \sin\alpha\sin\beta}{\cos\alpha\cos\beta} \\ &= \frac{\tan\alpha + \tan\beta}{1 - \tan\alpha\tan\beta}\end{aligned}$$

Again, if we replace β by $-\beta$ we have $\tan(\alpha - \beta) = \frac{\tan\alpha - \tan\beta}{1 + \tan\alpha\tan\beta}$.

And so we have the addition and difference identities for tangent:

$$\begin{aligned}\tan(\alpha + \beta) &= \frac{\tan\alpha + \tan\beta}{1 - \tan\alpha\tan\beta} \\ \tan(\alpha - \beta) &= \frac{\tan\alpha - \tan\beta}{1 + \tan\alpha\tan\beta}\end{aligned}$$

As a special case of the compound identities we have obtained so far, we have a set of identities known as the **double angle identities**.

Using the substitution $\theta = \alpha = \beta$ we obtain the identities:

$$\begin{aligned}\sin 2\theta &= 2\sin\theta\cos\theta \\ \cos 2\theta &= \cos^2\theta - \sin^2\theta\end{aligned}$$

i.e., substituting $\theta = \alpha = \beta$ into $\sin(\alpha + \beta) = \sin\alpha\cos\beta + \cos\alpha\sin\beta$ we obtain

$$\begin{aligned}\sin(\theta + \theta) &= \sin\theta\cos\theta + \cos\theta\sin\theta \\ \therefore \sin 2\theta &= 2\sin\theta\cos\theta\end{aligned}$$

Similarly, substituting $\theta = \alpha = \beta$ into $\cos(\alpha + \beta) = \cos\alpha\cos\beta - \sin\alpha\sin\beta$ we obtain

$$\begin{aligned}\cos(\theta + \theta) &= \cos\theta\cos\theta - \sin\theta\sin\theta \\ \therefore \cos 2\theta &= \cos^2\theta - \sin^2\theta\end{aligned}$$

The second of these can be further developed to give:

$$\cos 2\theta = \cos^2\theta - \sin^2\theta = \cos^2\theta - (1 - \cos^2\theta) = 2\cos^2\theta - 1$$

and

$$\cos 2\theta = \cos^2\theta - \sin^2\theta = (1 - \sin^2\theta) - \sin^2\theta = 1 - 2\sin^2\theta$$

Finally, we have a double angle identity for the tangent; $\tan 2\theta = \frac{2 \tan \theta}{1 - \tan^2 \theta}$.

Summary of double angle identities:

$$\begin{aligned}\sin 2\theta &= 2 \sin \theta \cos \theta \\ \cos 2\theta &= \cos^2 \theta - \sin^2 \theta \\ &= 2 \cos^2 \theta - 1 \\ &= 1 - 2 \sin^2 \theta \\ \tan 2\theta &= \frac{2 \tan \theta}{1 - \tan^2 \theta}\end{aligned}$$

We have seen how trigonometric identities can be used to solve equations, simplify expressions and to prove further identities. We now illustrate this using the new set of identities.

EXAMPLE 10.12

Simplify the expression: $\frac{\sin 3\alpha}{\sin \alpha} - \frac{\cos 3\alpha}{\cos \alpha}$.

S
o
l
u
t
i
o
n

$$\begin{aligned}\frac{\sin 3\alpha}{\sin \alpha} - \frac{\cos 3\alpha}{\cos \alpha} &= \frac{\sin 3\alpha \cos \alpha - \cos 3\alpha \sin \alpha}{\sin \alpha \cos \alpha} \\ &= \frac{\sin(3\alpha - \alpha)}{\sin \alpha \cos \alpha} \\ &= \frac{\sin 2\alpha}{\frac{1}{2} \sin 2\alpha} \\ &= 2\end{aligned}$$

EXAMPLE 10.13

Prove the identity $\cos 3\alpha = 4\cos^3 \alpha - 3\cos \alpha$.

S
o
l
u
t
i
o
n

$$\begin{aligned}\cos 3\alpha &= \cos(2\alpha + \alpha) \\ &= \cos 2\alpha \cos \alpha - \sin 2\alpha \sin \alpha \\ &= (2\cos^2 \alpha - 1)\cos \alpha - 2\sin \alpha \cos \alpha \sin \alpha \\ &= 2\cos^3 \alpha - \cos \alpha - 2\sin^2 \alpha \cos \alpha \\ &= 2\cos^3 \alpha - \cos \alpha - 2(1 - \cos^2 \alpha)\cos \alpha \\ &= 2\cos^3 \alpha - \cos \alpha - 2\cos \alpha + 2\cos^3 \alpha \\ &= 4\cos^3 \alpha - 3\cos \alpha\end{aligned}$$

EXAMPLE 10.14

Using a compound identity, show that $\cos\left(\frac{3\pi}{2} - \theta\right) = -\sin \theta$

$$\begin{aligned} \text{L.H.S} &= \cos\left(\frac{3\pi}{2} - \theta\right) \\ &= \cos\left(\frac{3\pi}{2}\right)\cos\theta + \sin\left(\frac{3\pi}{2}\right)\sin\theta \\ &= 0 \times \cos\theta + (-1) \times \sin\theta \\ &= -\sin\theta \\ &= \text{R.H.S} \end{aligned}$$

EXAMPLE 10.15

If $\sin\theta = \frac{3}{5}$ and $\cos\phi = -\frac{12}{13}$, where $0 \leq \theta \leq \frac{\pi}{2}$ and $\pi \leq \phi \leq \frac{3\pi}{2}$, find

- (a) $\sin(\theta + \phi)$ (b) $\cos(\theta + \phi)$ (c) $\tan(\theta - \phi)$

We start by drawing two right-angled triangles satisfying the given conditions:

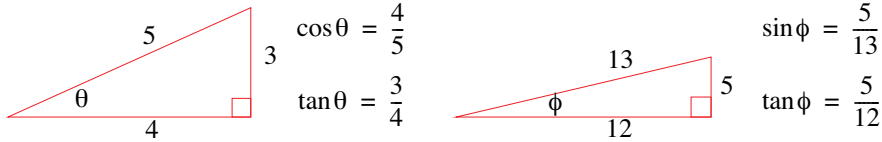

(a) $\sin(\theta + \phi) = \sin\theta\cos\phi + \sin\phi\cos\theta$

However, we cannot simply substitute the above ratios into this expression as we now need to consider the sign of the ratios.

As $0 \leq \theta \leq \frac{\pi}{2}$ then $\cos\theta = \frac{4}{5}$ and as $\pi \leq \phi \leq \frac{3\pi}{2}$ then $\sin\phi = -\frac{5}{13}$.

Therefore, $\sin(\theta + \phi) = \frac{3}{5} \times -\frac{12}{13} + -\frac{5}{13} \times \frac{4}{5} = -\frac{56}{65}$

(b) $\cos(\theta + \phi) = \cos\theta\cos\phi - \sin\theta\sin\phi$

As $0 \leq \theta \leq \frac{\pi}{2}$ then $\cos\theta = \frac{4}{5}$ and as $\pi \leq \phi \leq \frac{3\pi}{2}$ then $\sin\phi = -\frac{5}{13}$.

Therefore, $\cos(\theta + \phi) = \frac{4}{5} \times -\frac{12}{13} - \frac{3}{5} \times -\frac{5}{13} = -\frac{33}{65}$

(c) $\tan(\theta - \phi) = \frac{\tan\theta - \tan\phi}{1 + \tan\theta\tan\phi}$

As $0 \leq \theta \leq \frac{\pi}{2}$ then $\tan\theta = \frac{3}{4}$ and as $\pi \leq \phi \leq \frac{3\pi}{2}$ then $\tan\phi = \frac{5}{12}$.

Therefore, $\tan(\theta - \phi) = \frac{\frac{3}{4} - \frac{5}{12}}{1 + \frac{3}{4} \times \frac{5}{12}} = \frac{16}{63}$

EXAMPLE 10.16

If $\sin \theta = \frac{2}{7}$, where $\frac{\pi}{2} \leq \theta \leq \pi$ find

- (a) $\sin 2\theta$ (b) $\cos 2\theta$ (c) $\tan 2\theta$

S
o
l
u
t
i
o
n

We start by drawing the relevant right-angled triangle:

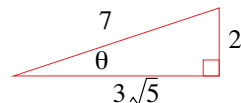

$$\begin{aligned} \text{(a)} \quad \sin 2\theta &= 2 \sin \theta \cos \theta = 2 \times \frac{2}{7} \times -\frac{3\sqrt{5}}{7} \\ &= -\frac{12\sqrt{5}}{49} \end{aligned}$$

$$\text{(b)} \quad \cos 2\theta = 1 - 2\sin^2 \theta = 1 - 2 \times \left(\frac{2}{7}\right)^2 = \frac{41}{49}$$

$$\text{(c)} \quad \tan 2\theta = \frac{\sin 2\theta}{\cos 2\theta} = \frac{-\frac{12\sqrt{5}}{49}}{\frac{41}{49}} = -\frac{12\sqrt{5}}{41}$$

EXAMPLE 10.17

Find the exact value of (a) $\cos 15^\circ$ (b) $\tan \frac{5\pi}{12}$

S
o
l
u
t
i
o
n

$$\begin{aligned} \text{(a)} \quad \cos 15^\circ &= \cos(45^\circ - 30^\circ) = \cos 45^\circ \cos 30^\circ + \sin 45^\circ \sin 30^\circ \\ &= \frac{1}{\sqrt{2}} \times \frac{\sqrt{3}}{2} + \frac{1}{\sqrt{2}} \times \frac{1}{2} \\ &= \frac{\sqrt{3} + 1}{2\sqrt{2}} \end{aligned}$$

$$\begin{aligned} \text{(b)} \quad \tan \frac{5\pi}{12} &= \tan\left(\frac{3\pi}{12} + \frac{2\pi}{12}\right) = \frac{\tan \frac{3\pi}{12} + \tan \frac{2\pi}{12}}{1 - \tan \frac{3\pi}{12} \tan \frac{2\pi}{12}} = \frac{\tan \frac{\pi}{4} + \tan \frac{\pi}{6}}{1 - \tan \frac{\pi}{4} \tan \frac{\pi}{6}} \\ &= \frac{1 + \frac{1}{\sqrt{3}}}{1 - 1 \times \frac{1}{\sqrt{3}}} \\ &= \frac{\sqrt{3} + 1}{\sqrt{3} - 1} \end{aligned}$$

Note: we used the fact that $\frac{5\pi}{12} = 5 \times \frac{\pi}{12} = 5 \times 15^\circ = 75^\circ = 45^\circ + 30^\circ = 3 \times \frac{\pi}{12} + 2 \times \frac{\pi}{12}$ to ‘break up’ the angle.

EXAMPLE 10.18

Prove that $\frac{\sin 2\phi + \sin \phi}{\cos 2\phi + \cos \phi + 1} = \tan \phi$

S
O
L
I
T
I
O
N

$$\begin{aligned} \text{(a) L.H.S} &= \frac{\sin 2\phi + \sin \phi}{\cos 2\phi + \cos \phi + 1} = \frac{2 \sin \phi \cos \phi + \sin \phi}{2 \cos^2 \phi - 1 + \cos \phi + 1} \\ &= \frac{\sin \phi (2 \cos \phi + 1)}{\cos \phi (2 \cos \phi + 1)} \\ &= \frac{\sin \phi}{\cos \phi} \\ &= \tan \phi \\ &= \text{R.H.S} \end{aligned}$$

EXAMPLE 10.19

Prove that (a) $\sin 2\alpha \tan \alpha + \cos 2\alpha = 1$
(b) $2 \cot 2\beta = \cot \beta - \tan \beta$

S
O
L
I
T
I
O
N

$$\begin{aligned} \text{(a) L.H.S} &= \sin 2\alpha \tan \alpha + \cos 2\alpha = 2 \sin \alpha \cos \alpha \times \frac{\sin \alpha}{\cos \alpha} + (1 - 2 \sin^2 \alpha) \\ &= 2 \sin^2 \alpha + 1 - 2 \sin^2 \alpha \\ &= 1 \\ &= \text{R.H.S} \end{aligned}$$

$$\begin{aligned} \text{(b) R.H.S} &= \cot \beta - \tan \beta = \frac{\cos \beta}{\sin \beta} - \frac{\sin \beta}{\cos \beta} \\ &= \frac{\cos^2 \beta - \sin^2 \beta}{\sin \beta \cos \beta} \\ &= \frac{\cos 2\beta}{\frac{1}{2} \sin 2\beta} \\ &= 2 \frac{\cos 2\beta}{\sin 2\beta} \\ &= 2 \cot 2\beta \\ &= \text{L.H.S} \end{aligned}$$

Notice that when proving identities, when all else fails, then express everything in terms of sine and cosine. This will always lead to the desired result – even though sometimes the working seems like it will only grow and grow – eventually, it does simplify. Be persistent.

To prove a given identity, any one of the following approaches can be used:

1. Start with the L.H.S and then show that L.H.S = R.H.S
2. Start with the R.H.S and then show that R.H.S = L.H.S
3. Show that L.H.S = p, show that R.H.S = p \Rightarrow L.H.S = R.H.S
4. Start with L.H.S = R.H.S \Rightarrow L.H.S – R.H.S = 0 .

When using approaches 1., and 2., choose whichever side has more to work with.

EXAMPLE 10.20

 Find all values of x , such that $\sin 2x = \cos x$, where $0 \leq x \leq 2\pi$.

Solution

$$\begin{aligned} \sin 2x = \cos x &\Leftrightarrow 2 \sin x \cos x = \cos x \\ &\Leftrightarrow 2 \sin x \cos x - \cos x = 0 \\ &\Leftrightarrow \cos x (2 \sin x - 1) = 0 \\ &\Leftrightarrow \cos x = 0 \text{ or } \sin x = \frac{1}{2} \end{aligned}$$

$$\text{Now, } \cos x = 0, 0 \leq x \leq 2\pi \Leftrightarrow x = \frac{\pi}{2}, \frac{3\pi}{2}$$

$$\text{and } \sin x = \frac{1}{2}, 0 \leq x \leq 2\pi \Leftrightarrow x = \frac{\pi}{6}, \frac{5\pi}{6}$$

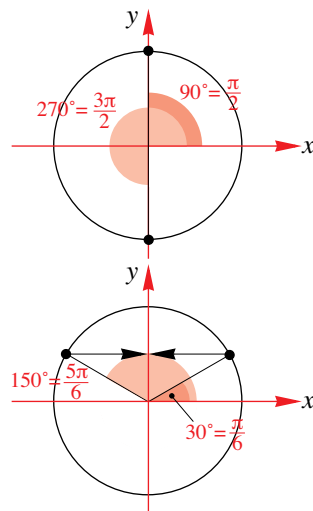
EXAMPLE 10.21

- (a) Simplify $\sqrt{2} \sin\left(\theta + \frac{\pi}{4}\right)$
- (b) Express $\cos \theta - \sin \theta$ in the form $R \cos(\theta + \alpha)$, where R and α are real numbers. Hence find the maximum value of $\cos \theta - \sin \theta$.

Solution

$$\begin{aligned} \text{(a) } \sqrt{2} \sin\left(\theta + \frac{\pi}{4}\right) &= \sqrt{2} \left[\sin \theta \cos \frac{\pi}{4} + \cos \theta \sin \frac{\pi}{4} \right] = \sqrt{2} \left[\sin \theta \times \frac{1}{\sqrt{2}} + \cos \theta \times \frac{1}{\sqrt{2}} \right] \\ &= \sin \theta + \cos \theta \end{aligned}$$

- (b) In this instance, as the statement needs to be true for all values of θ we will determine the values of R and α by setting $R \cos(\theta + \alpha) \equiv \cos \theta - \sin \theta$.

$$\text{Now, } R \cos(\theta + \alpha) = R[\cos \theta \cos \alpha - \sin \theta \sin \alpha] = R \cos \theta \cos \alpha - R \sin \theta \sin \alpha$$

Therefore, we have that $R \cos \theta \cos \alpha - R \sin \theta \sin \alpha \equiv \cos \theta - \sin \theta$

$$\Rightarrow R \cos \theta \cos \alpha = \cos \theta \Leftrightarrow R \cos \alpha = 1 \quad \text{(1)}$$

$$\Rightarrow R \sin \theta \sin \alpha = \sin \theta \Leftrightarrow R \sin \alpha = 1 \quad \text{(2)}$$

$$\text{Dividing (2) by (1) we have } \frac{R \sin \alpha}{R \cos \alpha} = \frac{1}{1} \Leftrightarrow \tan \alpha = 1 \therefore \alpha = \frac{\pi}{4}$$

$$\text{Substituting into (1) we have } R \cos \frac{\pi}{4} = 1 \Leftrightarrow R \times \frac{1}{\sqrt{2}} = 1 \therefore R = \sqrt{2}.$$

$$\text{Therefore, } \cos \theta - \sin \theta \equiv \sqrt{2} \cos\left(\theta + \frac{\pi}{4}\right)$$

Then, as the maximum value of the cosine is 1, the maximum of $\sqrt{2}\cos\left(\theta + \frac{\pi}{4}\right)$ is $\sqrt{2}$.

EXAMPLE 10.22

Express $3\cos\theta - 4\sin\theta$ in the form $R\cos(\theta \pm \alpha)$.

Hence solve the equation $3\cos\theta - 4\sin\theta = 2$ on the interval $[-1, 1]$, to 2 decimal places.

**S
o
l
v
i
n
g**

We are required to find the values of R & θ such that $R \cdot \cos(\theta - \alpha) \equiv 3\cos\theta - 4\sin\theta$.
Use the appropriate identity to expand the left hand side:

$$R\cos\theta\cos\alpha + R\sin\theta\sin\alpha \equiv 3\cos\theta - 4\sin\theta \quad (R > 0)$$

The values of R & θ must give an identity that is true for all values of θ . This means that both sides of the identity must have the same amount of $\cos\theta$ and $\sin\theta$ on each side. We must next equate coefficients of these variables.

Equating the coefficients of $\cos\theta$ gives: $R\cos\alpha = 3$ – (1)

Equating the coefficients of $\sin\theta$ gives: $R\sin\alpha = -4$ – (2)

Squaring and adding gives: $R^2\cos^2\alpha + R^2\sin^2\alpha = 3^2 + (-4)^2$

$$R^2(\cos^2\alpha + \sin^2\alpha) = 9 + 16$$

$$R^2 = 25$$

$$R = 5$$

Dividing (2) by (1) gives: $\frac{R\sin\alpha}{R\cos\alpha} = \frac{-4}{3}$

$$\tan\alpha = \frac{-4}{3}$$

$$\alpha \approx -0.927^c$$

It follows that $5 \cdot \cos(\theta + 0.927^c) \approx 3\cos\theta - 4\sin\theta$. This helps in finding the solution of the equation, which can be re-written as $5 \cdot \cos(\theta + 0.927^c) = 2$. The solution now follows:

$$5 \cdot \cos(\theta + 0.927^c) = 2$$

$$\cos(\theta + 0.927^c) = 0.4$$

$$\theta + 0.927^c = \pm 1.159^c \dots$$

$$\theta \approx 0.23 \text{ the only solution in the given interval.}$$

An extension of the compound and double angle identities is that of **half angle identities**, also referred to as **t substitution identities**.

Sometimes it is useful to make a substitution by letting $t = \tan\left(\frac{\theta}{2}\right)$.

$$\text{If } \tan\frac{\theta}{2} \equiv t \text{ then } \sin\theta \equiv \frac{2t}{1+t^2} \text{ and } \cos\theta \equiv \frac{1-t^2}{1+t^2}$$

$$\tan 2\phi \equiv \frac{2 \tan \phi}{1 - \tan^2 \phi} \text{ making the substitution } \phi = \frac{\theta}{2} \text{ gives: } \tan \theta \equiv \frac{2 \tan \frac{\theta}{2}}{1 - \tan^2 \frac{\theta}{2}} = \frac{2t}{1 - t^2}$$

This can be viewed (at least for acute angles) as a right-angled triangle

The hypotenuse of the triangle can be found using the theorem of Pythagoras:

$$\begin{aligned} h &= \sqrt{(2t)^2 + (1 - t^2)^2} = \sqrt{4t^2 + 1 - 2t^2 + t^4} \\ &= \sqrt{1 + 2t^2 + t^4} \\ &= \sqrt{(1 + t^2)^2} \\ &= 1 + t^2 \end{aligned}$$

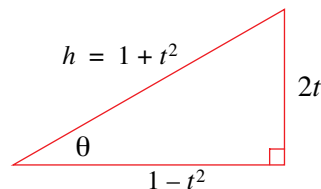

Two further identities follow: $\sin \theta \equiv \frac{2t}{1 + t^2}$ and $\cos \theta \equiv \frac{1 - t^2}{1 + t^2}$. These are useful in both calculus and trigonometry.

EXAMPLE 10.23

Solve the equation $\sin \theta + \cos \theta = 1$, $-\pi \leq \theta \leq \pi$.

Solution

$$\sin \theta + \cos \theta = 1, -\pi \leq \theta \leq \pi.$$

$$\text{Make the substitution: } \tan \frac{\theta}{2} \equiv t \Rightarrow \sin \theta \equiv \frac{2t}{1 + t^2} \text{ and } \cos \theta \equiv \frac{1 - t^2}{1 + t^2}$$

$$\text{The equation becomes: } \frac{2t}{1 + t^2} + \frac{1 - t^2}{1 + t^2} = 1 \Leftrightarrow 2t + 1 - t^2 = 1 + t^2$$

$$0 = 2t^2 - 2t$$

$$t = 0, 1$$

$$\tan \frac{\theta}{2} = 0 \Rightarrow \frac{\theta}{2} = 0 \Rightarrow \theta = 0.$$

$$\tan \frac{\theta}{2} = 1 \Rightarrow \frac{\theta}{2} = \frac{\pi}{4} \Rightarrow \theta = \frac{\pi}{2}$$

Other solutions are outside the interval.

Note: The section on half angle identities has been added as an extension to the prescribed H.L. syllabus. You should not expect to have questions that refer directly to half-angle identities in your examinations, however, such questions can be approached indirectly.

EXERCISES 10.2.2

1. Expand the following

(a) $\sin(\alpha + \phi)$

(b) $\cos(3\alpha + 2\beta)$

(c) $\sin(2x - y)$

(d) $\cos(\phi - 2\alpha)$

(e) $\tan(2\theta - \alpha)$

(f) $\tan(\phi - 3\omega)$

MATHEMATICS – Higher Level (Core)

2. Simplify the following

- (a) $\sin 2\alpha \cos 3\beta - \sin 3\beta \cos 2\alpha$ (b) $\cos 2\alpha \cos 5\beta - \sin 2\alpha \sin 5\beta$
(c) $\sin x \cos 2y + \sin 2y \cos x$ (d) $\cos x \cos 3y + \sin x \sin 3y$
(e) $\frac{\tan 2\alpha - \tan \beta}{1 + \tan 2\alpha \tan \beta}$ (f) $\frac{\tan(x-y) + \tan y}{1 - \tan(x-y) \tan y}$
(g) $\frac{1 - \tan \phi}{1 + \tan \phi}$ (h) $\frac{1}{\sqrt{2}} \sin(\alpha + \beta) + \frac{1}{\sqrt{2}} \cos(\alpha + \beta)$
(i) $\cos(x+2y) \sin(x-2y) + \sin(x+2y) \cos(x-2y)$

3. Given that $\sin \theta = \frac{4}{5}$, $0 \leq \theta \leq \frac{\pi}{2}$ and $\cos \phi = -\frac{5}{13}$, $\pi \leq \phi \leq \frac{3\pi}{2}$, evaluate

- (a) $\sin(\theta + \phi)$ (b) $\cos(\theta + \phi)$ (c) $\tan(\theta - \phi)$

4. Given that $\sin \theta = -\frac{3}{5}$, $\pi \leq \theta \leq \frac{3\pi}{2}$ and $\cos \phi = -\frac{12}{13}$, $\pi \leq \phi \leq \frac{3\pi}{2}$, evaluate

- (a) $\sin(\theta - \phi)$ (b) $\cos(\theta - \phi)$ (c) $\tan(\theta + \phi)$

5. Given that $\sin \theta = -\frac{5}{6}$, $\frac{3\pi}{2} \leq \theta \leq 2\pi$, evaluate

- (a) $\sin 2\theta$ (b) $\cos 2\theta$ (c) $\tan 2\theta$ (d) $\sin 4\theta$

6. Given that $\tan x = -3$, $\frac{\pi}{2} \leq x \leq \pi$, evaluate

- (a) $\sin 2x$ (b) $\cos 2x$ (c) $\tan 2x$ (d) $\tan 4x$

7. Find the exact value of

- (a) $\sin \frac{5\pi}{12}$ (b) $\sin 105^\circ$ (c) $\cos \frac{11\pi}{12}$ (d) $\tan 165^\circ$

8. Given that $\tan x = \frac{a}{b}$, $\pi \leq x \leq \frac{3\pi}{2}$, evaluate

- (a) $\sin 2x$ (b) $\operatorname{cosec} 2x$ (c) $\cos 4x$ (d) $\tan 2x$

9. Prove the following identities:

- (a) $\cot x - \cot 2x = \operatorname{cosec} 2x$ (b) $\sin(x+y) \sin(x-y) = \sin^2 x - \sin^2 y$
(c) $\sec^2 x = 1 + \tan^2 x$ (d) $\tan(\theta + \phi) + \tan(\theta - \phi) = \frac{2 \sin 2\theta}{\cos 2\theta + \cos 2\phi}$
(e) $\cos^4 \alpha - \sin^4 \alpha = 1 - 2 \sin^2 \alpha$ (f) $\frac{1}{\sin y \cos y} - \frac{\cos y}{\sin y} = \tan y$
(g) $\frac{1 + \cos 2y}{\sin 2y} = \frac{\sin 2y}{1 - \cos 2y}$ (h) $\csc\left(\theta + \frac{\pi}{2}\right) = \sec \theta$
(i) $\cos 3x = \cos x - 4 \sin^2 x \cos x$ (j) $\frac{1 + \sin 2\theta}{\cos 2\theta} = \frac{\cos \theta + \sin \theta}{\cos \theta - \sin \theta}$
(k) $(\cot x + \csc x)^2 = \frac{1 + \cos x}{1 - \cos x}$ (l) $\sin 3\alpha = 3 \sin \alpha - 4 \sin^3 \alpha$

$$\begin{array}{ll}
 \text{(m)} & \cos 2x = \frac{1 - \tan^2 x}{1 + \tan^2 x} \\
 \text{(o)} & \tan\left(\frac{\phi}{2}\right) = \csc \phi - \cot \phi \\
 \text{(q)} & \cos \beta + \sin \beta = \frac{\cos 2\beta}{\cos \beta - \sin \beta} \\
 \text{(s)} & \sin^2 \frac{\theta}{2} = \frac{1 - \cos \theta}{2} \\
 \text{(n)} & 2 \cot \theta \sin^2 \theta = \sin 2\theta \\
 \text{(p)} & 2 \csc x = \tan\left(\frac{x}{2}\right) + \cot\left(\frac{x}{2}\right) \\
 \text{(r)} & \tan \alpha + \tan \beta = \frac{\sin(\alpha + \beta)}{\cos \alpha \cos \beta} \\
 \text{(t)} & \frac{\sin^3 x + \cos^3 x}{\sin x + \cos x} = 1 - \frac{1}{2} \sin 2x
 \end{array}$$

10. Prove that

$$\begin{array}{l}
 \text{(a)} \quad \frac{1 + \sin x + \cos x}{1 + \sin x - \cos x} = \cot \frac{1}{2}x. \\
 \text{(b)} \quad \cos 4x = 8 \cos^4 x - 8 \cos^2 x + 1 \\
 \text{(c)} \quad \sin^4 \phi = \frac{3}{8} + \frac{1}{8} \cos 4\phi - \frac{1}{2} \cos 2\phi \\
 \text{(d)} \quad \sin x = \frac{2 \tan \frac{1}{2}x}{1 + \tan^2 \frac{1}{2}x}
 \end{array}$$

11. For the right-angled triangle shown, prove that

$$\begin{array}{ll}
 \text{(a)} \quad \sin 2\alpha = \frac{2ab}{c^2} & \text{(b)} \quad \cos 2\alpha = \frac{b^2 - a^2}{c^2} \\
 \text{(c)} \quad \sin \frac{1}{2}\alpha = \sqrt{\frac{c-b}{2c}} & \text{(d)} \quad \cos \frac{1}{2}\alpha = \sqrt{\frac{c+b}{2c}}
 \end{array}$$

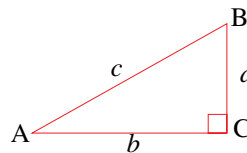

12. Find the exact value $\tan \frac{\pi}{8}$.

13. Given that $\alpha + \beta + \gamma = \pi$, prove that $\sin 2\alpha + \sin 2\beta + \sin 2\gamma = 4 \sin \alpha \sin \beta \sin \gamma$.

14. Solve the following for $0 \leq x \leq 2\pi$

$$\text{(a)} \quad \sin x = \sin 2x \quad \text{(b)} \quad \sin x = \cos 2x \quad \text{(c)} \quad \tan 2x = 4 \tan x$$

15. (a) Given that $a \sin \theta + b \cos \theta \equiv R \sin(\theta + \alpha)$, express R and α in terms of a and b .
 (b) Find the maximum value of $5 + 4 \sin \theta + 3 \cos \theta$.

16. (a) Given that $a \cos \theta + b \sin \theta \equiv R \cos(\theta - \alpha)$, express R and α in terms of a and b .
 (b) Find the minimum value of $2 + 12 \cos \theta + 5 \sin \theta$.

17. Using the t -substitution, prove that $\tan\left(\frac{\pi}{4} + \frac{1}{2}x\right) = \sec x + \tan x$.

18. Show that if $t = \tan \frac{\pi}{12}$ then $t^2 + 2\sqrt{3}t = 1$. Hence find the exact value of $\tan \frac{\pi}{12}$.

10.3 TRIGONOMETRIC FUNCTIONS

10.3.1 THE SINE, COSINE AND TANGENT FUNCTIONS

As we saw at the beginning of this chapter, there is an infinite set of angles all of which give values (when they exist) for the main trigonometric ratios. We also noticed that the trigonometric ratios behave in such a way that values are repeated over and over. This is known as **periodic** behaviour. Many real world phenomena are periodic in the sense that the same patterns repeat over time. The **trigonometric functions** are often used to model such phenomena which include sound waves, light waves, alternating current electricity and other more approximately periodic events such as tides and even our moods (i.e., biorythms).

Notice how we have introduced the term trigonometric function, replacing the term trigonometric ratio. By doing this we can extend the use of the trigonometric ratios to a new field of problems described at the end of the previous paragraph.

When the trigonometric functions are used for these purposes, the angles are almost always measured in **radians** (which is a different way of measuring angles). However there is no reason why we cannot use degrees. It will always be obvious from the equation as to which mode of angle we are using, an expression such as $\sin x$ will imply (by default) that the angle is measured in radians, otherwise it will be written as $\sin x^\circ$, implying that the angle is measured in degrees.

What do trigonometric functions look like?

The sine and cosine values have displayed a periodic nature. Meaning that if we were to plot a graph of the sine values versus their angles or the cosine values versus their angles, we could expect their graphs to demonstrate periodic behaviour. We start by plotting points.

The sine function:

θ	0	30	45	60	90	120	135	150	180	...	330	360
$\sin \theta^\circ$	0.0	0.5	0.71	0.87	1.0	0.86	0.71	0.5	0.0	...	-0.5	0.0

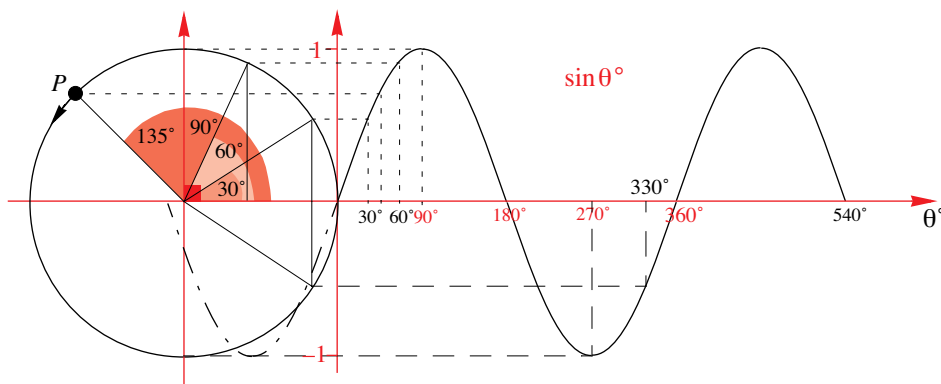

Notice that as the sine of angle θ corresponds to the y -value of a point P on the unit circle, as P moves around the circle in an anti-clockwise direction, we can measure the y -value and plot it on a graph as a function of θ (as shown above).

- Feature of sine graph:
1. Maximum value = 1, Minimum value = -1
 2. Period = 360° (i.e., graph repeats itself every 360°)
 3. If P moves in a clockwise direction, y -values continue in their periodic nature (see dashed part of graph).

The cosine function:

θ	0	30	45	60	90	120	135	150	180	...	330	360
$\cos \theta^\circ$	1.0	0.87	0.71	0.5	0.0	-0.5	-0.71	-0.87	-1.0	...	0.87	1.0

Plotting these points on a $\cos \theta^\circ$ versus θ -axis, we have:

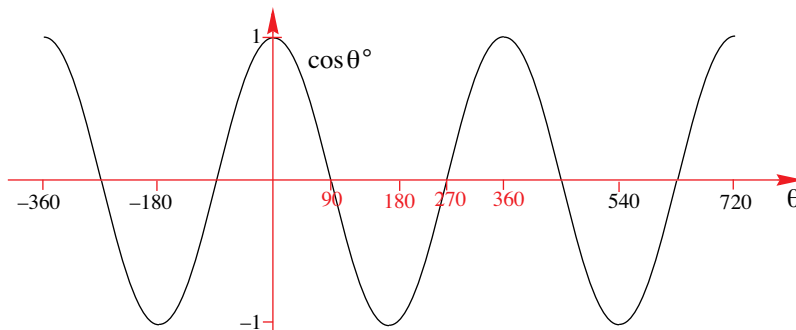

- Feature of cosine graph:
1. Maximum value = 1, Minimum value = -1
 2. Period = 360° (i.e., graph repeats itself every 360°)
 3. If P moves in a clockwise direction, x -values continue in their periodic nature.

There is a note to be made about using the second method (the one used to obtain the sine graph) when dealing with the cosine graph. As the cosine values correspond to the x -values on the unit circle, the actual cosine graph should have been plotted as shown below. However, for the sake of consistency, we convert the ‘vertical graph’ to the more standard ‘horizontal graph’:

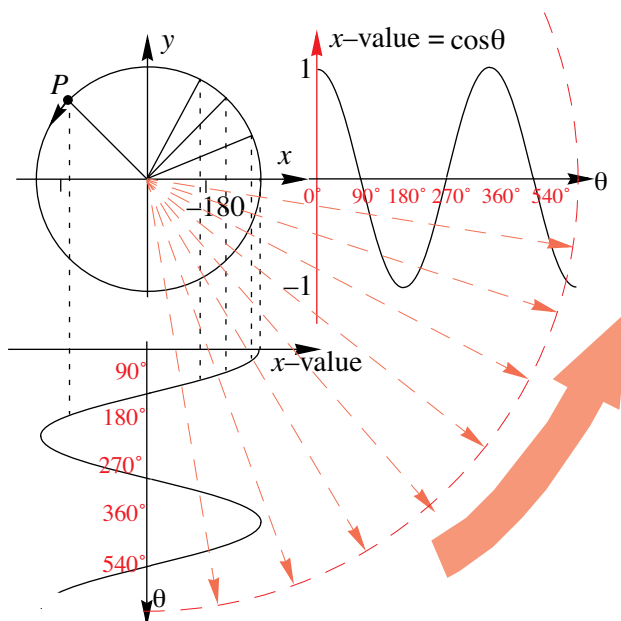

MATHEMATICS – Higher Level (Core)

There are some common observations to be made from these two graphs;

1. We have that the **period** of each of these functions is 360° . This is the length that it takes for the curve to start repeating itself.
2. The **amplitude** of the function is the distance between the centre line (in this case the θ -axis) and one of the maximum points. In this case, the amplitude is 1.

The sine and cosine functions are useful for modelling wave phenomena such as sound, light, water waves etc.

The third trigonometric function (tangent) is defined as $\tan \theta = \frac{\sin \theta}{\cos \theta}$ and so is defined for all angles for which the cosine function is non-zero.

The angles for which the tangent function are not defined correspond to the x -axis intercepts of the cosine function which are $\pm 90^\circ, \pm 270^\circ, \pm 450^\circ, \dots$. At these points the graph of the tangent function has **vertical asymptotes**.

The period of the tangent function is 180° , which is half that of the sine and cosine functions. Since the tangent function has a vertical asymptote, it cannot be said to have an amplitude. It is also generally true that the tangent function is less useful than the sine and cosine functions for modelling applications. The graph of the basic tangent function is:

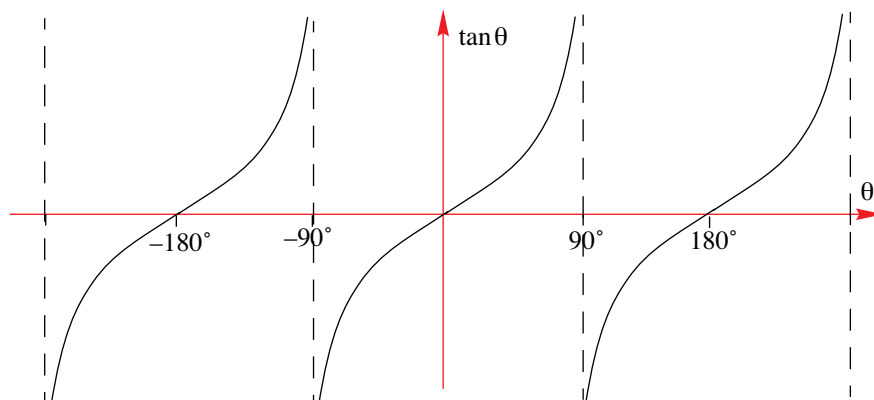

When sketching these graphs using the TI-83, be sure that the **WINDOW** settings are appropriate for the **MODE** setting. In the case of degrees we have:

Step 1. Make sure that the calculator is in degree mode. Failure to do this could be disastrous!

Step 2. Select an appropriate range

Step 3. Enter the function rule.

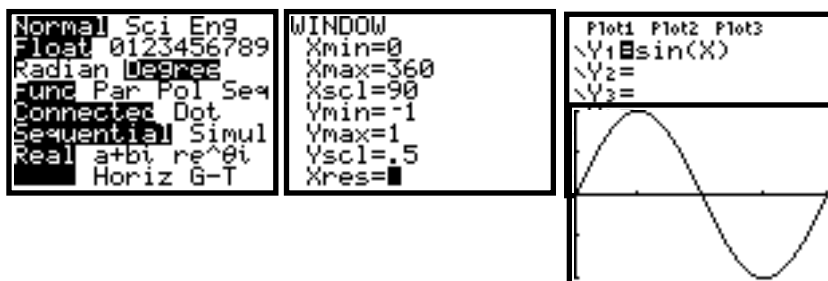

As we mentioned at the start of this section, angles measured in radians are much more useful when modelling situations that are cyclic or repetitive. And, although we have sketched the graphs of the sine, cosine and tangent functions using angles measured in degrees, it is reassuring to know that the shape of the graph does not alter when radians are used. The only difference between the graphs then is that 90° would be replaced by $\frac{\pi}{2}$, 180° by π and so on. We provide these graphs with the corresponding observations.

$$f : \mathbb{R} \mapsto \mathbb{R}, f(x) = \sin x$$

period 2π
amplitude 1

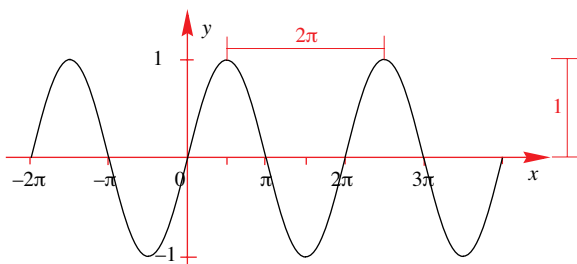

$$f : \mathbb{R} \mapsto \mathbb{R}, f(x) = \cos x$$

period 2π
amplitude 1

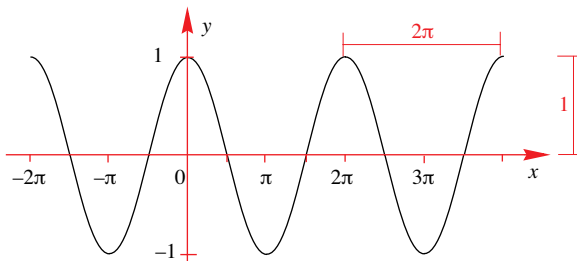

$$f : \mathbb{R} \mapsto \mathbb{R}, f(x) = \tan x, x \neq \frac{\pi}{2}, \frac{3\pi}{2}, \frac{5\pi}{2}, \dots$$

period π
no amplitude

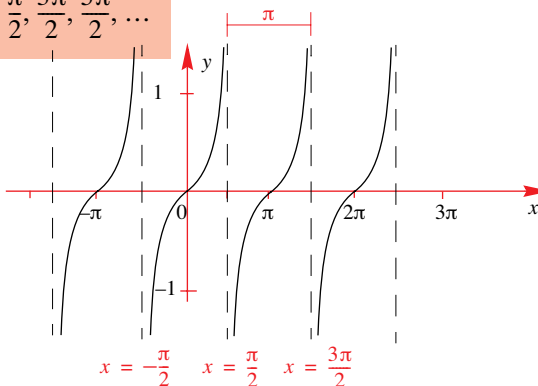

10.3.2 TRANSFORMATIONS OF TRIGONOMETRIC FUNCTIONS

We now consider some of the possible transformations that can be applied to the standard sine and cosine function and look at how these transformations affect the basic properties of both these graphs

1. Vertical translations

Functions of the type $f(x) = \sin(x) + c$, $f(x) = \cos(x) + c$ and $f(x) = \tan(x) + c$ represent vertical translations of the curves of $\sin(x)$, $\cos(x)$ and $\tan(x)$ respectively. If $c > 0$ the graph is moved **vertically up** and if $c < 0$ the graph is moved **vertically down**.

MATHEMATICS – Higher Level (Core)

That is, adding or subtracting a fixed amount to a trigonometric function translates the graph parallel to the y-axis.

EXAMPLE 10.24

Sketch the graphs of the functions for x values in the range -2π to 4π .

(a) $y = \sin(x) + 1$ (b) $y = \cos(x) - 2$

S
o
l
u
t
i
o
n

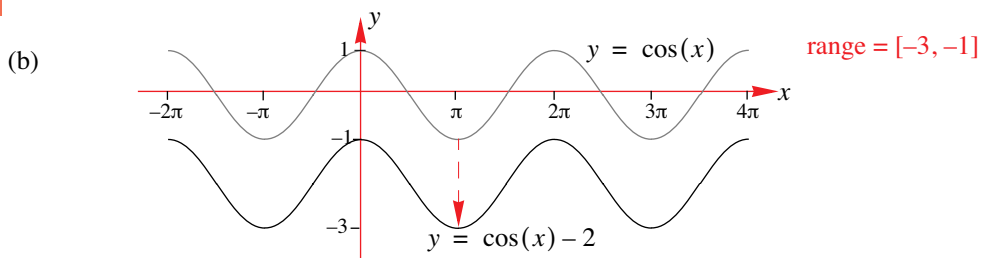
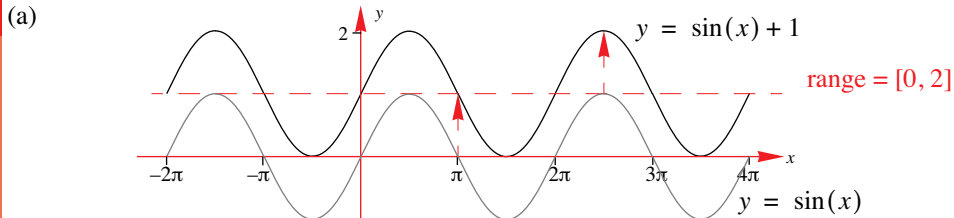

A graph sketch should show all the important features of a graph. In this case, the axes scales are important and should show the correct period (2π) and range $[-3, -1]$.

2. Horizontal translations

Functions of the type $f(x) = \sin(x \pm \alpha)$, $f(x) = \cos(x \pm \alpha)$ and $f(x) = \tan(x \pm \alpha)$ where $\alpha > 0$ are horizontal translations of the curves $\sin x$, $\cos x$ and $\tan x$ respectively.

So that $f(x) = \sin(x - \alpha)$, $f(x) = \cos(x - \alpha)$ and $f(x) = \tan(x - \alpha)$ are translations to the **right**.

while that of $f(x) = \sin(x + \alpha)$, $f(x) = \cos(x + \alpha)$ and $f(x) = \tan(x + \alpha)$ are translations to the **left**.

EXAMPLE 10.25

For $-2\pi \leq x \leq 4\pi$, sketch the graphs of the curves with equations

(a) $y = \cos\left(x - \frac{\pi}{4}\right)$ (b) $y = \cos\left(x + \frac{\pi}{3}\right)$ (c) $y = \tan\left(x - \frac{\pi}{6}\right)$

S
o
l
u
t
i
o
n

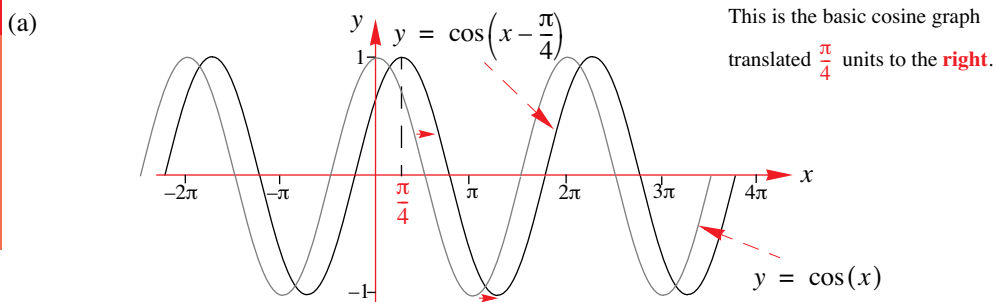

(b)

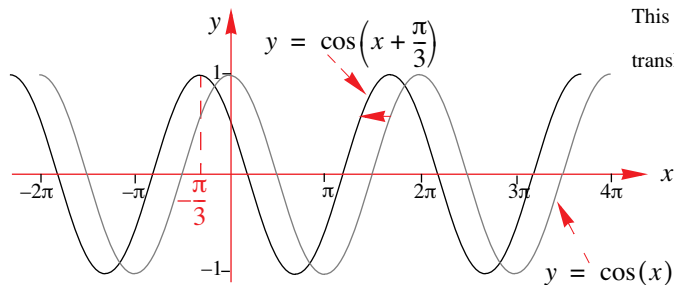

This graph is the basic cosine graph translated $\frac{\pi}{3}$ units to the **left**.

(c)

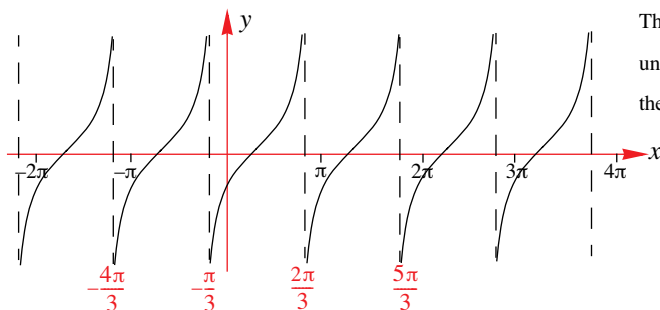

This is the tangent graph translated $\frac{\pi}{6}$ units to the **right**. This also translates the **asymptotes** $\frac{\pi}{6}$ units to the **right**.

Of course, it is also possible to combine vertical and horizontal translations, as the next example shows.

EXAMPLE 10.26

Sketch the graphs of the function $f(x) = \sin\left(x - \frac{\pi}{4}\right) + 2$, $-2\pi \leq x \leq 4\pi$.

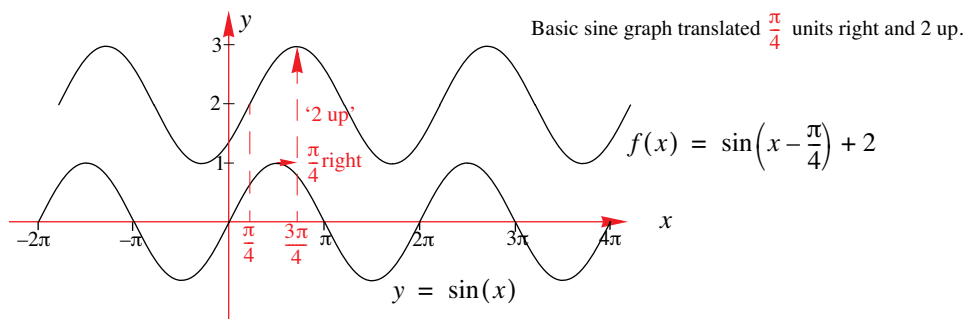
Solution

Basic sine graph translated $\frac{\pi}{4}$ units right and 2 up.

$$f(x) = \sin\left(x - \frac{\pi}{4}\right) + 2$$

3. Dilations

Functions of the form $f(x) = a \sin x$, $f(x) = a \cos(x)$ and $f(x) = a \tan(x)$ are **dilations** of the curves $\sin(x)$, $\cos(x)$ and $\tan(x)$ respectively, **parallel to the y-axis**.

In the case of the sine and cosine functions, the **amplitude** becomes $|a|$ and not 1. This dilation does not affect the shape of the graph. Also, as the tangent function extends indefinitely, the term amplitude has no relevance.

EXAMPLE 10.27

Sketch the graphs of the following functions for $-2\pi \leq x \leq 4\pi$.

(a) $f(x) = 2 \cos x$ (b) $f(x) = \frac{1}{3} \sin x$

S
o
l
u
t
i
o
n

(a)

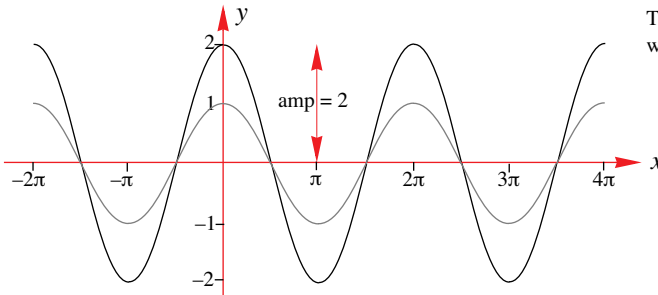

This is the cosine graph (broken line) with an amplitude of 2.

(b)

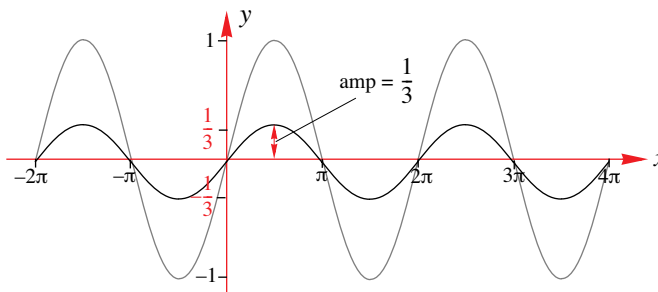

This is the sine graph (broken line) with an amplitude of $\frac{1}{3}$.

Functions of the form $f(x) = \cos(bx)$, $f(x) = \sin(bx)$ and $f(x) = \tan(bx)$ are **dilations** of the curves $\sin(x)$, $\cos(x)$ and $\tan(x)$ respectively, **parallel to the x-axis**.

This means that the **period** of the graph is **altered**. It can be valuable to remember and use the formula that relates the value of b to the **period** τ of the dilated function:

- 1.** The graph of $f(x) = \cos(bx)$ will show b cycles in 2π radians, meaning that its period will be given by $\tau = \frac{2\pi}{b}$.
- 2.** The graph of $f(x) = \sin(bx)$ will show b cycles in 2π radians, meaning that its period will be given by $\tau = \frac{2\pi}{b}$.
- 3.** The graph of $f(x) = \tan(bx)$ will show b cycles in π radians, meaning that its period will be given by $\tau = \frac{\pi}{b}$.

Note: In the case of the tangent function, whose original period is π , the period is $\tau = \frac{\pi}{n}$.

EXAMPLE 10.28

 Sketch graphs of the following functions for x values in the range -2π to 4π .

- (a)
- $f(x) = \sin(2x)$
- (b)
- $f(x) = \cos\left(\frac{x}{2}\right)$
- (c)
- $f(x) = \tan(2x)$

Solution

- (a)
- $f(x) = \sin(2x)$
- . The value of
- n
- is 2 so the period is
- $\tau = \frac{2\pi}{n} = \frac{2\pi}{2} = \pi$
- . Note that this means that the period is
- half**
- that of the basic sine function.

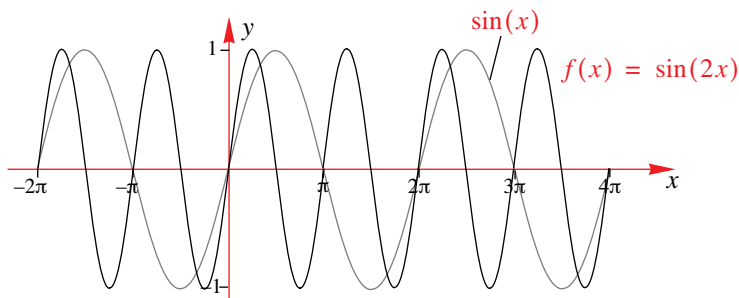

- (b)
- $f(x) = \cos\left(\frac{x}{2}\right)$
- . In this case the value of
- $n = \frac{1}{2}$
- and the period
- $\tau = \frac{2\pi}{n} = \frac{2\pi}{1/2} = 4\pi$
- . The graph is effectively stretched to twice its original period.

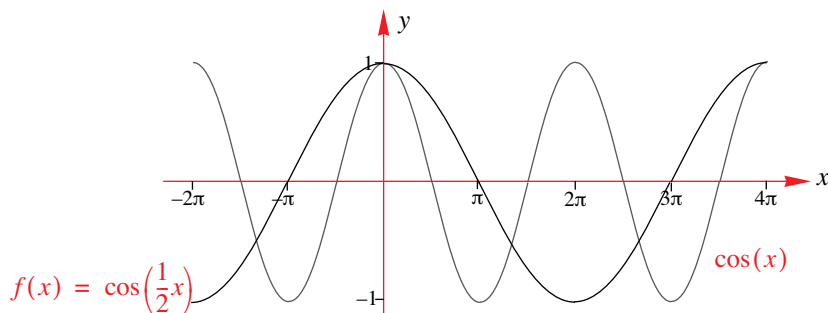

- (c) In this case, with
- $f(x) = \tan\left(\frac{x}{4}\right)$
- , the value of
- $n = \frac{1}{4}$
- and the period
- $\tau = \frac{\pi}{n} = 4\pi$
- .

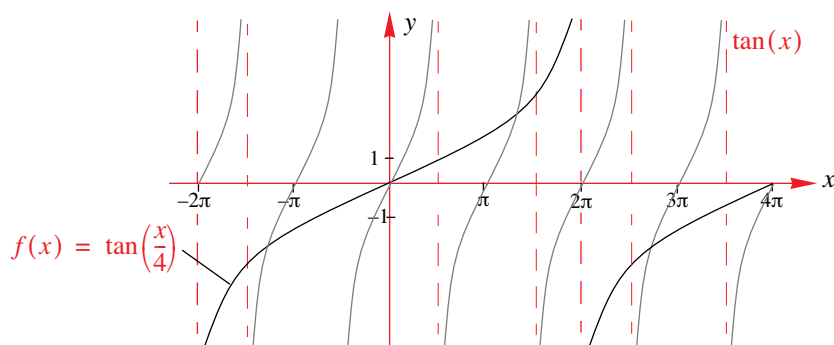

MATHEMATICS – Higher Level (Core)

4. Reflections

Recall that the graph of $y = -f(x)$ is the graph of $y = f(x)$ reflected about the x -axis, while that of $y = f(-x)$ is the graph of $y = f(x)$ reflected about the y -axis.

$f(x) = -\cos x$ is the basic cosine graph (broken line) **reflected in the x -axis**.

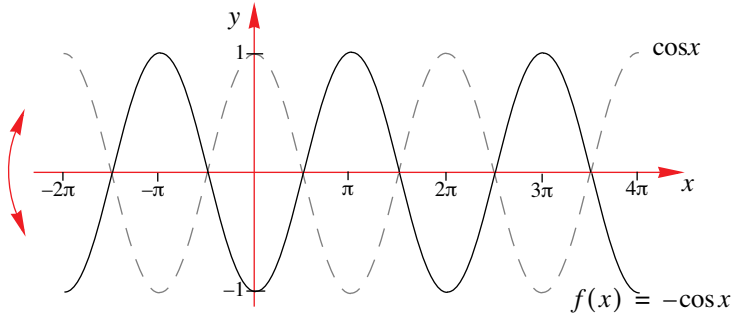

$f(x) = \sin(-x)$ is the basic sine graph **reflected in the y -axis**.

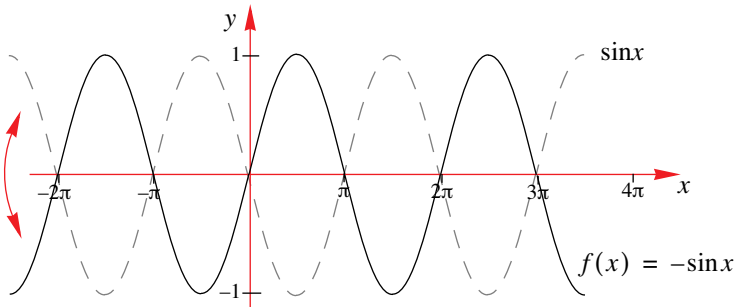

5. Combined transformations

You may be required to combine some or all of these transformations in a single function. The functions of the type

$$f(x) = a \sin[b(x+c)] + d \quad \text{and} \quad f(x) = a \cos[b(x+c)] + d$$

have:

1. an amplitude of $|a|$ (i.e., the absolute value of a).
2. a period of $\frac{2\pi}{b}$
3. a horizontal translation of c units, $c > 0 \Rightarrow$ to the left, $c < 0 \Rightarrow$ to the right
4. a vertical translation of d units, $d > 0 \Rightarrow$ up, $d < 0 \Rightarrow$ down

Care must be taken with the horizontal translation.

For example, the function $f(x) = 2 \cos\left(3x + \frac{\pi}{2}\right) - 1$ has a horizontal translation of $\frac{\pi}{6}$ to the

left, not $\frac{\pi}{2}$! This is because $f(x) = 2 \cos\left(3x + \frac{\pi}{2}\right) - 1 = 2 \cos\left[3\left(x + \frac{\pi}{6}\right)\right] - 1$. i.e., if the

coefficient of x is not one, we must first express the function in the form $a \cos[b(x+c)] + d$.

Similarly we have

$$f(x) = a \tan[b(x+c)] + d$$

has:

1. no amplitude (as it is not appropriate for the tan function).
2. a period of $\frac{\pi}{b}$
3. a horizontal translation of c units, $c > 0 \Rightarrow$ to the left, $c < 0 \Rightarrow$ to the right
4. a vertical translation of d units, $d > 0 \Rightarrow$ up, $d < 0 \Rightarrow$ down

EXAMPLE 10.29

Sketch graphs of the following functions for x values in the range -2π to 4π .

- (a) $f(x) = 2 \sin\left[2\left(x - \frac{\pi}{4}\right)\right] + 1$ (b) $f(x) = -\cos\frac{1}{2}\left(x - \frac{\pi}{3}\right) + 2$
- (c) $f(x) = -\frac{1}{2} \tan\frac{1}{2}\left(x - \frac{\pi}{2}\right)$

S
o
l
u
t
i
o
n

- (a) $f(x) = 2 \sin\left[2\left(x - \frac{\pi}{4}\right)\right] + 1$. This graph has an amplitude of 2, a period of π , a horizontal translation of $\frac{\pi}{4}$ units to the right and a vertical translation of 1 unit up.

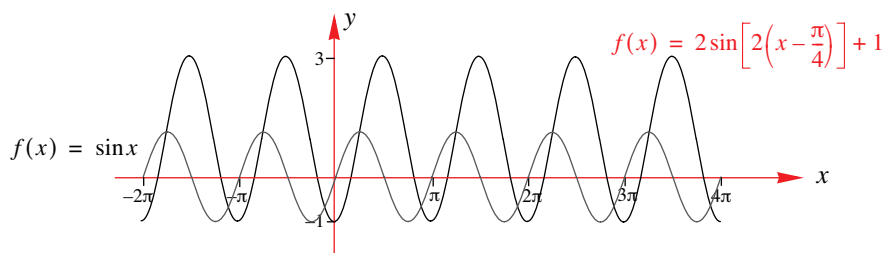

- (b) $f(x) = -\cos\frac{1}{2}\left(x - \frac{\pi}{3}\right) + 2$. The transformations are a reflection in the x -axis, a dilation of factor 2 parallel to the x -axis and a translation of $\frac{\pi}{3}$ right and 2 up.

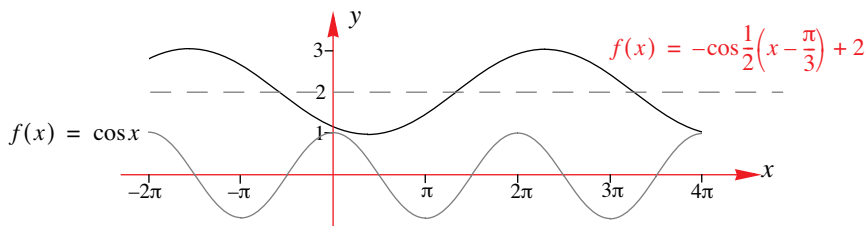

MATHEMATICS – Higher Level (Core)

- (b) $f(x) = -\frac{1}{2} \tan \frac{1}{2} \left(x - \frac{\pi}{2} \right)$. The transformations are a reflection in the x -axis, a vertical dilation with factor $\frac{1}{2}$, a horizontal dilation with factor 2 and a translation of $\frac{\pi}{2}$ to the right.

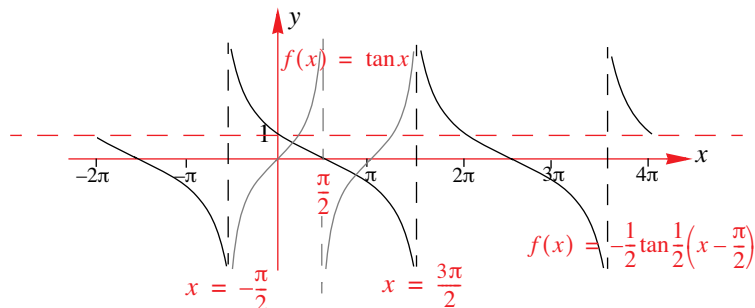

Again we see that a graphics calculator is very useful in such situations – in particular it allows for a checking process.

Example 10.28 (a) could be sketched as follows:

- Step 1.** Make sure that the calculator is in radian mode.
Failure to do this could be disastrous!

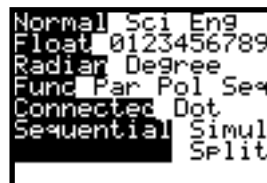

- Step 2.** Enter the function rule. Remember to use the π key where necessary.
Do not use approximations such as 3.14

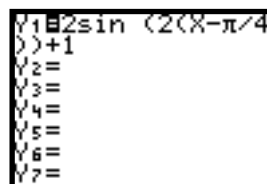

- Step 3.** Select an appropriate range. This may not be the ZTrig option (7) from the ZOOM menu.
However, this is probably a good place to start.



In this case, the viewing window is suitable, though it should be noted that it is not the specified range of x values $[-2\pi, 4\pi]$.

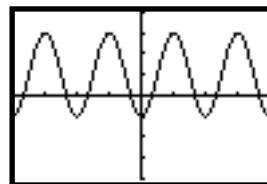

- Step 4.** Adjust the viewing window using the **WINDOW** menu. In this case it would be wise to select the correct set of x values.

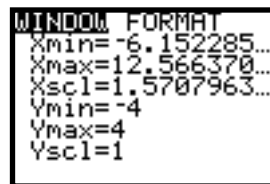

Finally use **GRAPH** to display the graph.

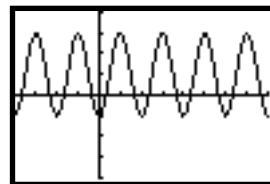

EXERCISES 10.3

- 1.** State the period of the following functions

(a) $f(x) = \sin \frac{1}{2}x$

(b) $f(x) = \cos 3x$

(c) $f(x) = \tan \frac{x}{3}$

(d) $g(x) = \cos\left(\frac{x}{2} - \pi\right)$

(e) $g(x) = 4 \sin(\pi x + 2)$

(f) $g(x) = 3 \tan\left(\frac{\pi}{2} - 2x\right)$

- 2.** State the amplitude of the following functions

(a) $f(x) = 5 \sin 2x$

(b) $g(x) = -3 \cos \frac{x}{2}$

(c) $g(x) = 4 - 5 \cos(2x)$

(d) $f(x) = \frac{1}{2} \sin(3x)$

- 3.** Find the period and, where appropriate, the amplitude of the following functions.

(a) $y = 2 \sin x$

(b) $y = 3 \cos \frac{x}{3}$

(c) $y = 3 \tan x$

(d) $2 \tan(x - 2\pi)$

(e) $y = -4 \sin\left[2\left(x + \frac{\pi}{6}\right)\right] + 1$

(f) $y = 2 - 3 \cos(2x - \pi)$

(g) $y = -2 \tan \frac{x}{6}$

(h) $y = \frac{1}{4} \cos\left[3\left(x - \frac{3\pi}{4}\right)\right] + 5$

(i) $y = 4 \tan\left(\frac{x-4}{3}\right) - 3$

(j) $y = -\frac{2}{3} \cos\left(\frac{3}{4}\left(x + \frac{3\pi}{5}\right)\right) + 5$

MATHEMATICS – Higher Level (Core)**4.** Sketch the graph of the curve with equation given by

(a) $y = 3 \cos x, 0 \leq x \leq 2\pi$

(b) $y = \sin \frac{x}{2}, -\pi \leq x \leq \pi$

(c) $y = 2 \cos\left(\frac{x}{3}\right), 0 \leq x \leq 3\pi$

(d) $y = -\frac{1}{2} \sin 3x, 0 \leq x \leq \pi$

(e) $y = 4 \tan\left(\frac{x}{2}\right), 0 \leq x \leq 2\pi$

(f) $y = \tan(-2x), -\pi \leq x \leq \frac{\pi}{4}$

(g) $y = \frac{1}{3} \cos(-3x), -\frac{\pi}{3} \leq x \leq \frac{\pi}{3}$

(h) $y = 3 \sin(-2x), -\pi \leq 0 \leq \pi$

5. Sketch the graph of the curve with equation given by

(a) $y = 3 \cos x + 3, 0 \leq x \leq 2\pi$

(b) $y = \sin \frac{x}{2} - 1, -\pi \leq x \leq \pi$

(c) $y = 2 \cos\left(\frac{x}{3}\right) - 2, 0 \leq x \leq 3\pi$

(d) $y = -\frac{1}{2} \sin 3x + 2, 0 \leq x \leq \pi$

(e) $y = 4 \tan\left(\frac{x}{2}\right) - 1, 0 \leq x \leq 2\pi$

(f) $y = \tan(-2x) + 2, -\pi \leq x \leq \frac{\pi}{4}$

(g) $y = \frac{1}{3} \cos(-3x) + \frac{1}{3}, -\frac{\pi}{3} \leq x \leq \frac{\pi}{3}$

(h) $y = 3 \sin(-2x) - 2, -\pi \leq 0 \leq \pi$

6. Sketch the graph of the curve with equation given by

(a) $y = 3 \cos\left(x + \frac{\pi}{2}\right), 0 \leq x \leq 2\pi$

(b) $y = \sin\left(\frac{x}{2} - \pi\right), -\pi \leq x \leq \pi$

(c) $y = 2 \cos\left(\frac{x}{3} + \frac{\pi}{6}\right), 0 \leq x \leq 3\pi$

(d) $y = -\frac{1}{2} \sin(3x + 3\pi), 0 \leq x \leq \pi$

(e) $y = 4 \tan\left(\frac{x}{2} - \frac{\pi}{4}\right), 0 \leq x \leq 2\pi$

(f) $y = \tan(-2x + \pi), -\pi \leq x \leq \frac{\pi}{4}$

(g) $y = \frac{1}{3} \cos(-3x - \pi), -\frac{\pi}{3} \leq x \leq \frac{\pi}{3}$

(h) $y = 3 \sin\left(-2x - \frac{\pi}{2}\right), -\pi \leq 0 \leq \pi$

7. Sketch graphs of the following functions for x values in the interval $[-2\pi, 2\pi]$.

(a) $y = \sin(2x)$

(b) $y = -\cos\left(\frac{x}{2}\right)$

(c) $y = 3 \tan\left(x - \frac{\pi}{4}\right)$

(d) $y = 2 \sin\left(x - \frac{\pi}{2}\right)$

(e) $y = 1 - 2 \sin(2x)$

(f) $y = -2 \cos\left(\frac{x - \pi}{2}\right)$

(g) $y = 3 \tan\left[\frac{1}{2}\left(x + \frac{\pi}{4}\right)\right] - 3$

(h) $y = 3 \cos\left(x + \frac{\pi}{4}\right)$

- (i) $y = 2 \sin \left[\frac{1}{3} \left(x + \frac{2\pi}{3} \right) \right] - 1$ (j) $y = 3 \tan(2x + \pi)$
- (k) $y = 4 \sin \left(\frac{x + \frac{\pi}{2}}{2} \right)$ (l) $y = 2 - \sin \left(\frac{2(x - \pi)}{3} \right)$
- (m) $y = 2 \cos(\pi x)$ (n) $y = 2 \sin[\pi(x + 1)]$

- 8.** (a) i. Sketch one cycle of the graph of the function $f(x) = \sin x$.
- ii. For what values of x is the function $y = \frac{1}{f(x)}$ not defined?
- iii. Hence, sketch one cycle of the graph of the function $g(x) = \operatorname{cosec} x$.
- (b) i. Sketch one cycle of the graph of the function $f(x) = \cos x$.
- ii. For what values of x is the function $y = \frac{1}{f(x)}$ not defined?
- iii. Hence, sketch one cycle of the graph of the function $g(x) = \sec x$.
- (c) i. Sketch one cycle of the graph of the function $f(x) = \tan x$.
- ii. For what values of x is the function $y = \frac{1}{f(x)}$ not defined?
- iii. Hence, sketch one cycle of graph of the function $g(x) = \cot x$.

10.4 INVERSE TRIGONOMETRIC FUNCTIONS

10.4.1 THE INVERSE SINE FUNCTION

The trigonometric functions are many to one which means that, unless we are careful about defining domains, their inverses are not properly defined. The basic graphs of the sine function and its inverse (after reflection about the line $y = x$ for the $\arcsin x$ function) are:

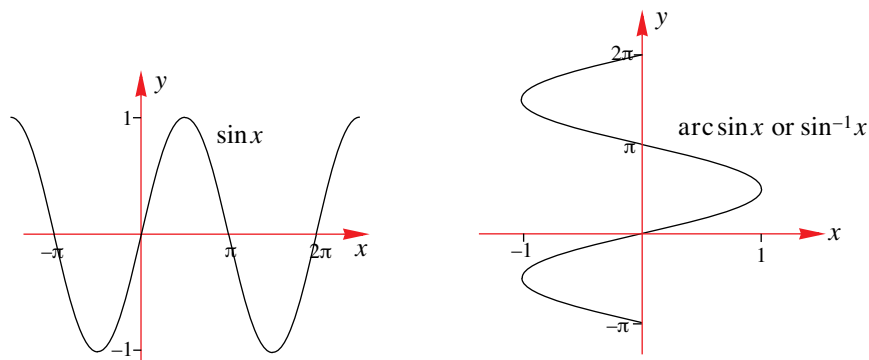

The inverse as depicted here is not a function (as it is one:many). This is inconvenient as the inverse trigonometric functions are useful. The most useful solution to this problem is to restrict the domain of the function to an interval over which it is one to one. In the case of the sine function, this is usually taken as $\left[-\frac{\pi}{2}, \frac{\pi}{2} \right]$, though this is not the only possible choice, it is one that

- (d) As $\sin \pi \in [-1, 1] \Rightarrow \text{Sin}^{-1}(\sin \pi)$ exists. So, $\text{Sin}^{-1}(\sin \pi) = \text{Sin}^{-1}(0) = 0$.
Note that $\text{Sin}^{-1}(\sin \pi) \neq \pi$! Why?

10.4.2 THE INVERSE COSINE FUNCTION

For similar reasons as those for the sine function, the cosine function, $\cos x, x \in]-\infty, \infty[$ being a many to one function, with its inverse, $\arccos x, -1 \leq x \leq 1$ (or $\cos^{-1}x, -1 \leq x \leq 1$) needs to be restricted to the domain $[0, \pi]$, to produce a function that is one to one.

The function $y = \text{Cos}(x), x \in [0, \pi], -1 \leq y \leq 1$ (with a capital ‘C’) will have the inverse function defined as $f(x) = \text{Cos}^{-1}(x), -1 \leq x \leq 1, 0 \leq y \leq \pi$. The graphs of these functions are:

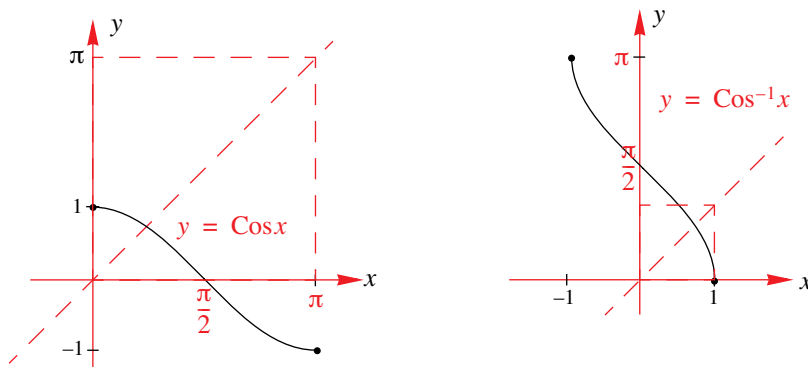

Notice then that the domain of $\text{Cos}^{-1}x = \text{range of } \text{Cos } x = [-1, 1]$
and the range of $\text{Cos}^{-1}x = \text{domain of } \text{Cos } x = [0, \pi]$.

When these restrictions are adhered to, we refer to $\text{Cos}^{-1}x$ (which is sometimes denoted by $\text{Arccos } x$) as the **principal value** of $\arccos x$.

From our fundamental identity property of inverse functions, i.e., $f \circ f^{-1}(x) = f^{-1} \circ f(x) = x$, we have that

$$\text{Cos}(\text{Cos}^{-1}x) = x, -1 \leq x \leq 1 \quad \text{and} \quad \text{Cos}^{-1}(\text{Cos } x) = x, 0 \leq x \leq \pi$$

Therefore, $\text{Cos}(\text{Cos}^{-1}x) = x = \text{Cos}^{-1}(\text{Cos } x)$ only if $0 \leq x \leq 1$.

This then means that sometimes we can provide a meaningful interpretation of expressions such as $\text{cos}(\text{Cos}^{-1}x)$ and $\text{Cos}^{-1}(\text{cos } x)$ – as long as we adhere to the relevant restrictions.

Note also that in this case, $\text{Cos}^{-1}(-x) \neq -\text{Cos}^{-1}(x)$.

EXAMPLE 10.31

Give the exact value of

- (a) $\text{Cos}^{-1}\frac{1}{2}$ (b) $\text{Arccos}\left(-\frac{\sqrt{3}}{2}\right)$ (c) $\text{Cos}^{-1}\left(\text{cos}\left(\frac{3\pi}{2}\right)\right)$

S
o
l
u
t
i
o
n

(a) As $\frac{1}{2} \in [-1, 1] \Rightarrow \text{Cos}^{-1}\frac{1}{2}$ exists. Therefore, $\text{Cos}^{-1}\frac{1}{2} = \frac{\pi}{3}$.

(b) As $-\frac{\sqrt{3}}{2} \in [-1, 1] \Rightarrow \text{Cos}^{-1}\left(-\frac{\sqrt{3}}{2}\right)$ exists.

Let $y = \text{Cos}^{-1}\left(-\frac{\sqrt{3}}{2}\right)$, then, $\text{Cos} y = -\frac{\sqrt{3}}{2}$, $0 \leq y \leq \pi$.

$$\begin{aligned} \Leftrightarrow y &= \pi - \frac{\pi}{6} \\ &= \frac{5\pi}{6} \end{aligned}$$

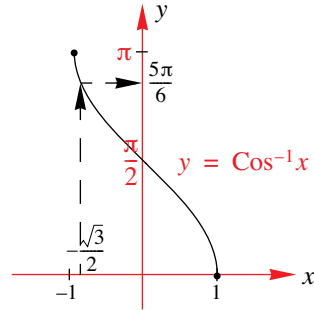

(c) As $\cos\left(\frac{3\pi}{2}\right) \in [-1, 1] \Rightarrow \text{Cos}^{-1}\left(\cos\left(\frac{3\pi}{2}\right)\right)$ exists. $\text{Cos}^{-1}\left(\cos\left(\frac{3\pi}{2}\right)\right) = \text{Cos}^{-1}(0) = \frac{\pi}{2}$.

Notice that $\text{Cos}^{-1}\left(\cos\left(\frac{3\pi}{2}\right)\right) \neq \frac{3\pi}{2}$.

E **EXAMPLE 10.32**

Give the exact value of

- (a) $\sin\left(\text{Arccos}\left(\frac{1}{\sqrt{2}}\right)\right)$ (b) $\cos\left(\text{Sin}^{-1}\left(\frac{1}{4}\right)\right)$ (c) $\sin\left(\frac{\pi}{2} - \text{Cos}^{-1}\left(\frac{3}{4}\right)\right)$

S
o
l
u
t
i
o
n

(a) Let $\text{Arccos}\left(\frac{1}{\sqrt{2}}\right) = x$. \therefore as $\frac{1}{\sqrt{2}} \in [0, 1] \Rightarrow \text{Arccos}\left(\frac{1}{\sqrt{2}}\right) = \frac{\pi}{4}$.

Then, $\sin\left(\text{Arccos}\left(\frac{1}{\sqrt{2}}\right)\right) = \sin(x) = \sin\frac{\pi}{4} = \frac{1}{\sqrt{2}}$.

(b) Let $\text{Sin}^{-1}\left(\frac{1}{4}\right) = x$. \therefore as $\frac{1}{4} \in [-1, 1] \Rightarrow \text{Sin}^{-1}\left(\frac{1}{4}\right)$ exists.

However, this time we cannot obtain an exact value for x , so we make use of a right-angled triangle:

Therefore, from the triangle we have that $\cos x = \frac{\sqrt{15}}{4}$.

i.e., $\cos\left(\text{Sin}^{-1}\left(\frac{1}{4}\right)\right) = \cos x = \frac{\sqrt{15}}{4}$.

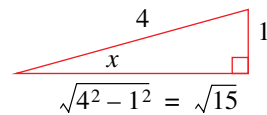

(c) Let $\text{Cos}^{-1}\left(\frac{3}{4}\right) = \theta$. \therefore as $\frac{3}{4} \in [-1, 1] \Rightarrow \text{Cos}^{-1}\left(\frac{3}{4}\right)$ exists.

Then, $\sin\left(\frac{\pi}{2} - \text{Cos}^{-1}\left(\frac{3}{4}\right)\right) = \sin\left(\frac{\pi}{2} - \theta\right) = \cos\theta$.

Therefore, $\sin\left(\frac{\pi}{2} - \text{Cos}^{-1}\left(\frac{3}{4}\right)\right) = \cos\left(\text{Cos}^{-1}\left(\frac{3}{4}\right)\right) = \frac{3}{4}$

EXAMPLE 10.33

Give the exact value of

$$(a) \quad \sin\left(\cos^{-1}\left(\frac{1}{3}\right) + \sin^{-1}\left(\frac{3}{4}\right)\right) \quad (b) \quad \cos\left(2\sin^{-1}\left(\frac{2}{\sqrt{5}}\right)\right)$$

S
o
l
u
t
i
o
n

(a) As $\frac{1}{3} \in [-1, 1]$ and $\frac{3}{4} \in [-1, 1]$ then both $\cos^{-1}\left(\frac{1}{3}\right)$ and $\sin^{-1}\left(\frac{3}{4}\right)$ exist.

Using the compound angle formula for sine, we have that

$$\begin{aligned} & \sin\left(\cos^{-1}\left(\frac{1}{3}\right) + \sin^{-1}\left(\frac{3}{4}\right)\right) \\ &= \sin\left(\cos^{-1}\left(\frac{1}{3}\right)\right) \cos\left(\sin^{-1}\left(\frac{3}{4}\right)\right) + \sin\left(\sin^{-1}\left(\frac{3}{4}\right)\right) \cos\left(\cos^{-1}\left(\frac{1}{3}\right)\right) \\ &= \sin\left(\cos^{-1}\left(\frac{1}{3}\right)\right) \cos\left(\sin^{-1}\left(\frac{3}{4}\right)\right) + \frac{3}{4} \times \frac{1}{3} \end{aligned}$$

However, we now need to construct two right-angled triangles to evaluate the first part of the expression. Let $x = \cos^{-1}\left(\frac{1}{3}\right)$ and $y = \sin^{-1}\left(\frac{3}{4}\right)$ so that we have the following triangles:

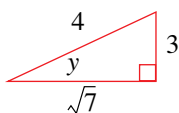
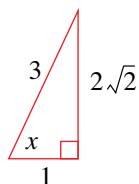

Meaning that $\sin\left(\cos^{-1}\left(\frac{1}{3}\right)\right) = \sin x = \frac{2\sqrt{2}}{3}$

and $\cos\left(\sin^{-1}\left(\frac{3}{4}\right)\right) = \cos y = \frac{\sqrt{7}}{4}$

$$\text{Therefore, } \sin\left(\cos^{-1}\left(\frac{1}{3}\right) + \sin^{-1}\left(\frac{3}{4}\right)\right) = \frac{2\sqrt{2}}{3} \times \frac{\sqrt{7}}{4} + \frac{3}{4} \times \frac{1}{3} = \frac{2\sqrt{14} + 3}{12}$$

(b) As $\frac{2}{\sqrt{5}} \in [-1, 1] \Rightarrow \sin^{-1}\left(\frac{2}{\sqrt{5}}\right)$ exists. Next, let $\theta = \sin^{-1}\left(\frac{2}{\sqrt{5}}\right)$, i.e., $\sin\theta = \frac{2}{\sqrt{5}}$.

Then, using the double angle formula for cosine, we have

$$\begin{aligned} \cos\left(2\sin^{-1}\left(\frac{2}{\sqrt{5}}\right)\right) &= \cos(2\theta) = 1 - 2\sin^2\theta \\ &= 1 - 2[\sin\theta]^2 \\ &= 1 - 2\left[\frac{2}{\sqrt{5}}\right]^2 \\ &= -\frac{3}{5} \end{aligned}$$

10.4.3 THE INVERSE TANGENT FUNCTION

The tangent function can be made one:one by restricting its domain to the open interval $\left(-\frac{\pi}{2}, \frac{\pi}{2}\right)$.

$$f(x) = \tan(x), x \in \left(-\frac{\pi}{2}, \frac{\pi}{2}\right).$$

MATHEMATICS – Higher Level (Core)

The function $y = \tan(x)$, $x \in \left(-\frac{\pi}{2}, \frac{\pi}{2}\right)$, $-\infty < y < \infty$, (with a capital ‘T’) will have the inverse function defined as $f(x) = \tan^{-1}(x)$, $-\infty < x < \infty$. The graphs of these functions are:

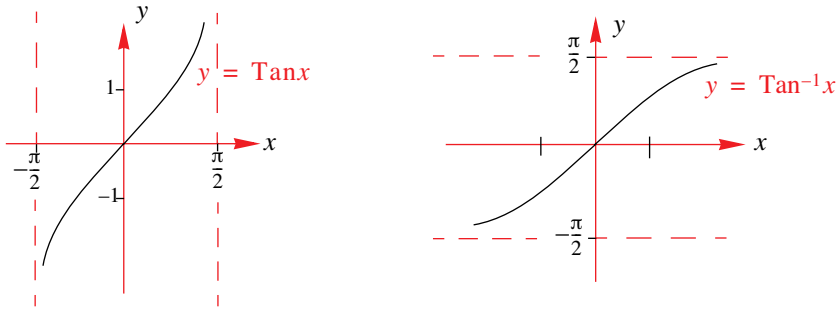

Notice then that the domain of $\tan^{-1}x = \text{range of } \tan x = (-\infty, \infty)$

$$\text{and the range of } \tan^{-1}x = \text{domain of } \tan x = \left(-\frac{\pi}{2}, \frac{\pi}{2}\right).$$

When these restrictions are adhered to, we refer to $\tan^{-1}x$ (which is sometimes denoted by $\text{Arctan } x$) as the **principal value** of $\arctan x$.

From our fundamental identity property of inverse functions, i.e., $f \circ f^{-1}(x) = f^{-1} \circ f(x) = x$, we have that

$$\tan(\tan^{-1}x) = x, -\infty < x < \infty \text{ and } \tan^{-1}(\tan x) = x, -\frac{\pi}{2} < x < \frac{\pi}{2}$$

Therefore, $\tan(\tan^{-1}x) = x = \tan^{-1}(\tan x)$ only if $-\frac{\pi}{2} < x < \frac{\pi}{2}$.

As we saw with the sine and cosine functions, it **may** also be possible to evaluate expressions such as $\tan(\tan^{-1}x)$ and $\tan^{-1}(\tan x)$.

For example, $\tan(\tan^{-1}1) = \tan\left(\frac{\pi}{4}\right) = 1$, however, $\tan^{-1}\left(\tan\frac{2\pi}{3}\right) = \tan^{-1}(-\sqrt{3}) = -\frac{\pi}{3}$.

Note also that $\tan^{-1}(-x) = -\tan^{-1}(x)$

EXAMPLE 10.34

Give the exact value of

(a) $\tan\left(\sin^{-1}\left(-\frac{3}{5}\right)\right)$ (b) $\sin\left(2\tan^{-1}\left(\frac{1}{3}\right)\right)$

(a) As $-\frac{3}{5} \in [-1, 1] \Rightarrow \sin^{-1}\left(-\frac{3}{5}\right)$ exists. Then, we let $\theta = \sin^{-1}\left(\frac{3}{5}\right)$, so that $\sin\theta = \frac{3}{5}$.

Next we construct an appropriate right-angled triangle:

So, $\tan\left(\sin^{-1}\left(-\frac{3}{5}\right)\right) = \tan\left(-\sin^{-1}\left(\frac{3}{5}\right)\right) = \tan(-\theta) = -\tan\theta = -\frac{3}{4}$

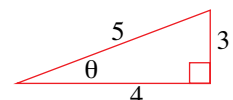

(b) As $\frac{1}{3} \in (-\infty, \infty) \Rightarrow \tan^{-1}\left(\frac{1}{3}\right)$ exists. Let $\tan^{-1}\left(\frac{1}{3}\right) = \theta \therefore \tan \theta = \frac{1}{3}$.

Next we construct an appropriate right-angled triangle:

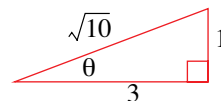

$$\begin{aligned} \text{Then, } \sin\left(2\tan^{-1}\left(\frac{1}{3}\right)\right) &= \sin 2\theta = 2 \sin \theta \cos \theta \\ &= 2 \times \frac{1}{\sqrt{10}} \times \frac{3}{\sqrt{10}} \\ &= \frac{3}{5} \end{aligned}$$

It is these restricted functions that are programmed into most calculators, spreadsheets etc. If the calculator is set in radian mode, some sample calculations are:

$$\begin{aligned} \sin^{-1} \frac{1}{2} &= \frac{\pi}{6} \\ \cos^{-1} \frac{\sqrt{3}}{2} &= \frac{\pi}{6} \\ \tan^{-1} -1 &= -\frac{\pi}{4} \end{aligned}$$

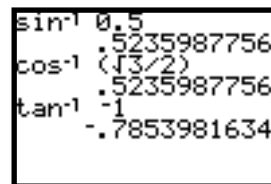

If the calculator is set in degree mode, the results are:

$$\begin{aligned} \sin^{-1} \frac{1}{2} &= 30^\circ \\ \cos^{-1} \frac{\sqrt{3}}{2} &= 30^\circ \\ \tan^{-1} -1 &= -45^\circ \end{aligned}$$

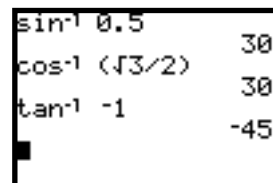

Note that, when using a calculator in radian mode, answers that are multiples of π can be difficult to find. Not many of us know that 0.5235987756 is $\frac{\pi}{6}$. It can be a good idea to work on the calculator in degrees, even when the final answers are required in radians. Thus, in the above example, $\cos^{-1} \frac{\sqrt{3}}{2} = 30^\circ \Rightarrow \cos^{-1} \frac{\sqrt{3}}{2} = 30 \times \frac{\pi}{180} = \frac{\pi}{6}$ could be a good way to infer the exact radian answer. It is not a good idea to work with approximations, unless you are told to do so.

EXAMPLE 10.35

Find the principal values of the following

- (a) $\sin^{-1}\left(-\frac{1}{2}\right)$ (b) $\cos^{-1}\left(-\frac{1}{\sqrt{2}}\right)$ (c) $\tan^{-1}\sqrt{3}$

S
o
l
u
t
i
o
n

- (a) $\sin^{-1}\left(-\frac{1}{2}\right) = -30^\circ$ from a calculator in degree mode. The radian answer is $-\frac{\pi}{6}$.
 (b) $\cos^{-1}\left(-\frac{1}{\sqrt{2}}\right) = 135^\circ$ from a calculator in degree mode. The radian answer is $\frac{3\pi}{4}$.

- (c) $\tan^{-1}\sqrt{3} = 60^\circ$ from a calculator in degree mode. The radian answer is $\frac{\pi}{3}$.

EXERCISES 10.4

1. Find the principal values of the following, giving answers in radians:

(a) $\tan^{-1}1$	(b) $\arcsin 1$	(c) $\arccos -1$
(d) $\sin^{-1}\frac{\sqrt{3}}{2}$	(e) $\cos^{-1}\frac{1}{\sqrt{2}}$	(f) $\tan^{-1}-\sqrt{3}$
(g) $\tan^{-1}2$	(h) $\sin^{-1}0.7$	(i) $\arctan 0.1$
(j) $\arccos 0.3$	(k) $\sin^{-1}0.6$	(l) $\tan^{-1}5$
(m) $\cos^{-1}3$	(n) $\tan^{-1}-30$	(o) $\sin^{-1}\left(\frac{7}{8}\right)$

2. Solve the following equations, giving exact answers

(a) $\arctan x = \frac{3\pi}{4}$ (b) $\arcsin(2x) = \frac{\pi}{3}$ (c) $\arccos(3x) = \frac{5\pi}{4}$

3. Prove (a) $\arctan(4) - \arctan\left(\frac{3}{5}\right) = \frac{\pi}{4}$

(b) $\sin^{-1}\left(\frac{4}{5}\right) + \sin^{-1}\left(-\frac{4}{5}\right) = 0$

(c) $\sin^{-1}\left(\frac{3}{5}\right) + \tan^{-1}\left(\frac{7}{24}\right) = \cos^{-1}\left(\frac{3}{5}\right)$

4. Solve for x , where $\arctan(3x) - \arctan(2x) = \arctan\left(\frac{1}{5}\right)$

5. Find the exact value of

(a) $\sin\left[\frac{\pi}{2} - \cos^{-1}\left(\frac{2}{3}\right)\right]$ (b) $\cos\left[\frac{\pi}{2} + \sin^{-1}\left(-\frac{1}{3}\right)\right]$

(c) $\cos[\tan^{-1}(-\sqrt{3})]$ (d) $\tan\left(\cos^{-1}\left(\frac{4}{5}\right)\right)$

(e) $\sec\left(\sin^{-1}\left(-\frac{1}{3}\right)\right)$ (f) $\cot(\tan^{-1}(-1))$

6. Find the exact value of

(a) $\sin\left[\sin^{-1}\left(\frac{3}{5}\right) + \sin^{-1}\left(\frac{4}{5}\right)\right]$ (b) $\sin\left[\sin^{-1}\left(\frac{3}{5}\right) + \sin^{-1}\left(-\frac{4}{5}\right)\right]$

$$\begin{array}{ll}
 \text{(c)} & \cos\left[\tan^{-1}\left(\frac{4}{3}\right) - \cos^{-1}\left(\frac{5}{13}\right)\right] \\
 \text{(d)} & \tan\left[\tan^{-1}\left(\frac{4}{3}\right) + \tan^{-1}\left(\frac{3}{4}\right)\right] \\
 \text{(e)} & \sin\left(2\arcsin\left(\frac{2}{3}\right)\right) \\
 \text{(f)} & \cos\left(2\tan^{-1}\left(-\frac{1}{2}\right)\right) \\
 \text{(g)} & \tan\left(2\cos^{-1}\left(\frac{2}{\sqrt{5}}\right)\right) \\
 \text{(h)} & \cos\left(2\sin^{-1}\left(-\frac{1}{2}\right)\right)
 \end{array}$$

7. Prove that

$$\begin{array}{ll}
 \text{(a)} & \sin^{-1}\left(\frac{7}{25}\right) = \cos^{-1}\left(\frac{24}{25}\right) \\
 \text{(b)} & \tan^{-1}\left(\frac{1}{2}\right) + \tan^{-1}\left(\frac{1}{3}\right) = \frac{\pi}{4} \\
 \text{(c)} & \tan^{-1}(1) + \tan^{-1}(2) + \tan^{-1}(3) = \pi
 \end{array}$$

8. Prove that

$$\begin{array}{ll}
 \text{(a)} & \sin^{-1}x = \cos^{-1}\sqrt{1-x^2}, 0 \leq x \leq 1 \\
 \text{(b)} & \cos^{-1}x = \sin^{-1}\sqrt{1-x^2}, 0 \leq x \leq 1 \\
 \text{(c)} & \tan^{-1}x + \tan^{-1}y = \tan^{-1}\left(\frac{x+y}{1-xy}\right), \text{ for all real } x \text{ and } y, xy \neq 1. \\
 \text{(d)} & \tan^{-1}x - \tan^{-1}y = \tan^{-1}\left(\frac{x-y}{1+xy}\right), \text{ for all real } x \text{ and } y, xy \neq -1.
 \end{array}$$

9. Find

$$\begin{array}{ll}
 \text{(a)} & \tan(\cos^{-1}k), \text{ where } -1 \leq k \leq 1, k \neq 0. \\
 \text{(b)} & \cos(\tan^{-1}k), \text{ where } k \text{ is a real number.}
 \end{array}$$

10. (a) State the implied domain of the following functions and sketch their graphs

$$\begin{array}{ll}
 \text{(a)} & f(x) = \sin^{-1}\left(\frac{x}{2}\right) + \frac{\pi}{2} \\
 \text{(b)} & f(x) = \cos^{-1}(2x) - \pi \\
 \text{(c)} & g(x) = 2\sin^{-1}(x-1) \\
 \text{(d)} & h(x) = \cos^{-1}(x+2) - \frac{\pi}{2}
 \end{array}$$

11. (a) Prove that $\sin^{-1}\left(\frac{x}{\sqrt{1+x^2}}\right) = \tan^{-1}x$, for all real x .

(b) Prove that $\cos^{-1}\left(\frac{1}{\sqrt{1+x^2}}\right) = \tan^{-1}x$, for all real x .

12. (a) On the same set of axes sketch the graphs of $y = \cos^{-1}x$ and $y = \sin^{-1}x$.
 (b) Hence, deduce the value of k , where

i. $\cos^{-1}x + \sin^{-1}x = k, -1 \leq x \leq 0$

ii. $\cos^{-1}x + \sin^{-1}x = k, 0 \leq x \leq 1$

(c) On a separate set of axes, sketch the graph of $y = \cos^{-1}x + \sin^{-1}x, -1 \leq x \leq 1$.

13. Prove that if $n > 1$ then $\arctan\left(\frac{1}{n}\right) - \arctan\left(\frac{1}{n+1}\right) = \arctan\left(\frac{1}{1+n(n+1)}\right)$.

Hence, find $\sum_{i=1}^n \arctan\left(\frac{1}{1+i(i+1)}\right)$.

10.5 TRIGONOMETRIC EQUATIONS

We have already encountered solutions to trigonometric equations as part of a general observation in this chapter. There are two basic methods that can be used when solving trigonometric equations;

Method 1. Use the unit circle as a visual aid.

Method 2. Use the graph of the function as a visual aid.

The method you choose depends entirely on what you feel comfortable with. However, it is recommended that you become familiar with both methods.

10.5.1 SOLUTION TO $\sin x = a$, $\cos x = a$ & $\tan x = a$

The equation $\sin x = \frac{1}{2}$ produces an infinite number of solutions. This can be seen from the graph of the sine function.

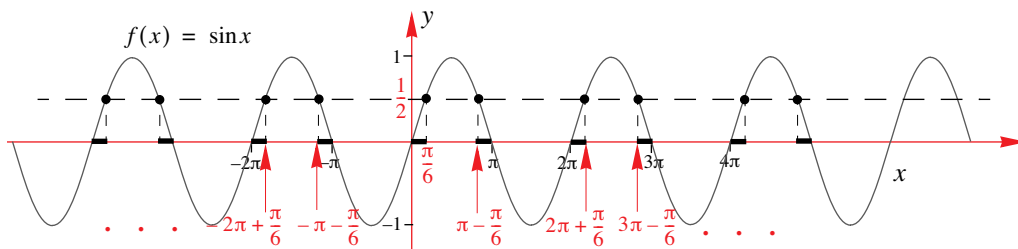

Using the **principal angle** $\left(\frac{\pi}{6}\right)$ and **symmetry**, the solutions generated are

$$\begin{aligned} \text{For } x \geq 0: \quad x &= \frac{\pi}{6}, \pi - \frac{\pi}{6}, 2\pi + \frac{\pi}{6}, 3\pi - \frac{\pi}{6}, \dots \\ &= \frac{\pi}{6}, \frac{5\pi}{6}, \frac{13\pi}{6}, \frac{17\pi}{6}, \dots \end{aligned}$$

$$\begin{aligned} \text{For } x < 0: \quad x &= -\pi - \frac{\pi}{6}, -2\pi + \frac{\pi}{6}, -3\pi - \frac{\pi}{6}, \dots \\ &= -\frac{7\pi}{6}, -\frac{11\pi}{6}, -\frac{19\pi}{6}, \dots \end{aligned}$$

That is, $\sin x = \frac{1}{2} \Leftrightarrow x = \dots, -\frac{7\pi}{6}, -\frac{11\pi}{6}, -\frac{19\pi}{6}, \frac{\pi}{6}, \frac{5\pi}{6}, \frac{13\pi}{6}, \frac{17\pi}{6}, \dots$

or, $x = n\pi + (-1)^n \times \frac{\pi}{6}$, where n is an integer (including zero).

The solution $x = n\pi + (-1)^n \times \frac{\pi}{6}$ is known as the **general solution**. However, in this course,

there will always be some restriction on the domain. For example, solve $\sin x = \frac{1}{2}$, $-2\pi < x < \pi$,

which would then give $x = -\frac{7\pi}{6}, -\frac{11\pi}{6}, \frac{\pi}{6}, \frac{5\pi}{6}$ as its solutions.

The same problem could have been solved using Method 1. We start by drawing a unit circle and we continue to move around the circle until we have all the required solutions within the domain restriction. Again, the use of symmetry plays an important role in solving these equations.

For $x \geq 0$:

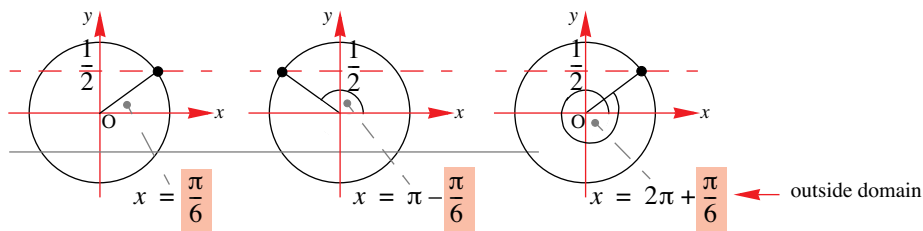

For $x < 0$:

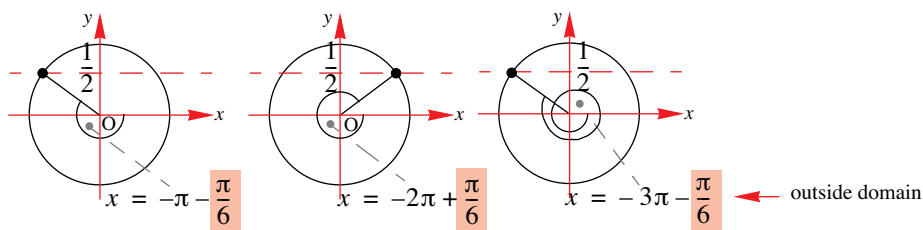

Again, for the restricted domain $-2\pi < x < \pi$, we have $\sin x = \frac{1}{2}$ if $x = -\frac{7\pi}{6}, -\frac{11\pi}{6}, \frac{\pi}{6}, \frac{5\pi}{6}$.

The process is identical for the cosine and tangent function.

EXAMPLE 10.36

Solve the following, for $0 \leq x \leq 4\pi$, giving answers to 4 decimal places if no exact answers are available.

- (a) $\cos x = 0.4$ (b) $\tan x = -1$ (c) $5 \cos x - 2 = 0$

S
o
l
u
t
i
o
n

- (a) **Step 1:** Find the **reference angle**: $x = \text{Cos}^{-1}(0.4) = 1.1593$.
Step 2: Sketch the cosine graph (or use the unit circle):

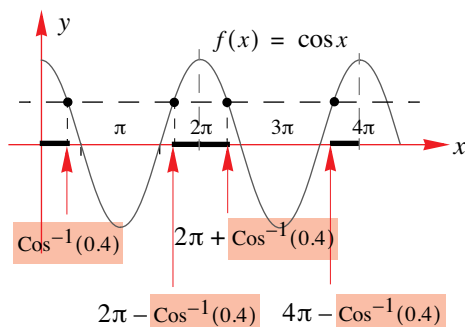

Step 3: Use the reference angle and symmetry to obtain solutions.

Therefore, solutions are, $x = \text{Cos}^{-1}(0.4), 2\pi - \text{Cos}^{-1}(0.4), 2\pi + \text{Cos}^{-1}(0.4), 4\pi - \text{Cos}^{-1}(0.4)$
 $= 1.1593, 5.1239, 7.4425, 11.4071$

- Step 4:** Check that
- i. all solutions are within the domain
 - ii. you have obtained all the solutions in the domain. (Use the graphics calculator to check).

MATHEMATICS – Higher Level (Core)

Using the TI-83 we count the number of intersections for $y = 0.4$ and $y = \cos x$:

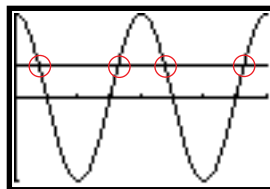
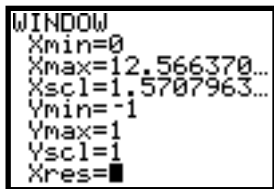
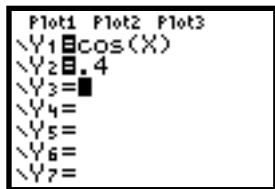

4 solutions are required.

(b) **Step 1:** Find reference angle (in first quadrant): $\tan^{-1}(1) = \frac{\pi}{4}$.

Step 2: Sketch the tangent graph (or use the unit circle):

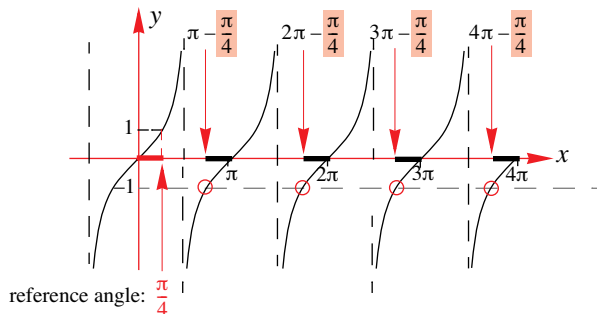

Step 3: Use the reference angle and symmetry to obtain solutions.

Reference angle is $\frac{\pi}{4}$.

$$\begin{aligned} \text{Therefore solutions are } x &= \pi - \frac{\pi}{4}, 2\pi - \frac{\pi}{4}, 3\pi - \frac{\pi}{4}, 4\pi - \frac{\pi}{4} \\ &= \frac{3\pi}{4}, \frac{7\pi}{4}, \frac{11\pi}{4}, \frac{15\pi}{4} \end{aligned}$$

From the TI-83 display, we see that there are four solutions.

Then, as the four solutions obtained all lie in the interval $[0, 4\pi]$

Step 4 is satisfied.

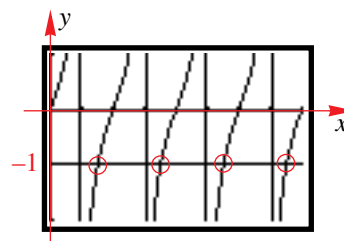

(c) $5 \cos x - 2 = 0 \Leftrightarrow 5 \cos x = 2 \Leftrightarrow \cos x = \frac{2}{5}$

i.e., $\cos x = 0.4$

Which is in fact, identical to the equation in part (a) and so, we have that

$$x = 1.1593, 5.1239, 7.4425, 11.4071$$

Part (c) in Example 10.36 highlights the fact that it is possible to transpose a trigonometric equation into a simpler form, which can readily be solved. Rather than remembering (or trying to commit to memory) the different possible forms of trigonometric equations and their specific solution processes, the four steps used (with possibly some algebraic manipulation) will always transform a (seemingly) difficult equation into one having a simpler form, as in Example 10.36.

Some forms of trigonometric equations are:

$$\sin(kx) = a, \cos(x+c) = a, \tan(kx+c) = a, b\cos(kx+c) = a, b\sin(kx+c) + d = a$$

And of course, then there are equations involving the secant, cosecant and cotangent functions. But even the most involved of these equations, e.g., $b\sin(kx+c) + d = a$, can be reduced to a simpler form:

1. Transpose:

$$\begin{aligned} b\sin(kx+c) + d = a &\Leftrightarrow b\sin(kx+c) = a-d \\ &\Leftrightarrow \sin(kx+c) = \frac{a-d}{b} \end{aligned}$$

2. Substitute:

Then, setting $kx+c = \theta$ and $\frac{a-d}{b} = m$, we have $\sin\theta = m$ which can be readily solved.

3. Solve for new variable:

So that the solutions to $\sin\theta = m$ are $\theta = \theta_1, \theta_2, \theta_3, \dots$

4. Solve for original variable:

We substitute back for θ and solve for x :

$$\begin{aligned} kx+c &= \theta_1, \theta_2, \theta_3, \dots \\ \Leftrightarrow kx &= \theta_1-c, \theta_2-c, \theta_3-c, \dots \\ \Leftrightarrow x &= \frac{\theta_1-c}{k}, \frac{\theta_2-c}{k}, \frac{\theta_3-c}{k}, \dots \end{aligned}$$

All that remains is to check that all the solutions have been obtained and that they all lie in the restricted domain.

The best way to see how this works is through a number of examples.

EXAMPLE 10.37

Solve the following, for $0 \leq x \leq 2\pi$

(a) $\cos(2x) = 0.4$ (b) $\tan\left(\frac{1}{2}x\right) = -1$

Solution

(a) Let $\theta = 2x$, so that we now solve the equation $\cos\theta = 0.4$.

From Example 10.36 (a) we already have the solutions, namely;

$$\begin{aligned} \theta &= \cos^{-1}(0.4), 2\pi - \cos^{-1}(0.4), 2\pi + \cos^{-1}(0.4), 4\pi - \cos^{-1}(0.4) \\ &= 1.1593, 5.1239, 7.4425, 11.4071 \end{aligned}$$

However, we want to solve for x not θ . So, we substitute back for x :

$$\begin{aligned} \text{i.e., } 2x &= 1.1593, 5.1239, 7.4425, 11.4071 \\ \therefore x &= 0.5796, 2.5620, 3.7212, 5.7045 \end{aligned}$$

To check that we have all the solutions, we sketch the graphs of $y = \cos(2x)$ and $y = 0.4$ over the domain $0 \leq x \leq 2\pi$. The diagram shows that there should be four solutions.

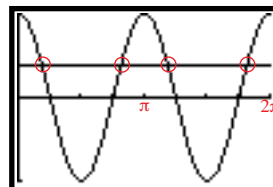

MATHEMATICS – Higher Level (Core)

- (b) This time, to solve $\tan\left(\frac{1}{2}x\right) = -1$ we first let $\theta = \frac{1}{2}x$ so that we now need to solve the simpler equation $\tan\theta = -1$.

From Example 10.35 (b) we have that

$$\begin{aligned}\theta &= \pi - \frac{\pi}{4}, 2\pi - \frac{\pi}{4}, 3\pi - \frac{\pi}{4}, 4\pi - \frac{\pi}{4} \\ &= \frac{3\pi}{4}, \frac{7\pi}{4}, \frac{11\pi}{4}, \frac{15\pi}{4}\end{aligned}$$

However, we want to solve for x , not θ . So, we substitute for x :

$$\begin{aligned}\frac{1}{2}x &= \frac{3\pi}{4}, \frac{7\pi}{4}, \frac{11\pi}{4}, \frac{15\pi}{4} \\ \therefore x &= \frac{3\pi}{2}, \frac{7\pi}{2}, \frac{11\pi}{2}, \frac{15\pi}{2}\end{aligned}$$

To check that we have all the solutions, we sketch the graphs of

$$y = \tan\left(\frac{1}{2}x\right) \text{ and } y = -1 \text{ over the domain } 0 \leq x \leq 2\pi.$$

The diagram shows that there should be only one solution.

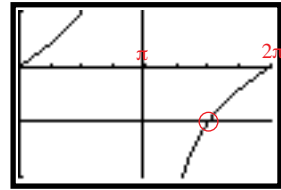

Therefore, the only solution is $x = \frac{3\pi}{2}$.

There is of course another step that could be used to help us predetermine which solutions are valid. This requires that we make a substitution not only into the equation, but also into the restricted domain statement.

In Example 10.36 (b), after setting $\theta = \frac{1}{2}x$ to give $\tan\theta = -1$, we next adjust the restricted

domain as follows: $\theta = \frac{1}{2}x \Leftrightarrow x = 2\theta$.

So, from $0 \leq x \leq 2\pi$ we now have $0 \leq 2\theta \leq 2\pi \Leftrightarrow 0 \leq \theta \leq \pi$.

That is, we have the equivalent equations:

$$\tan\left(\frac{1}{2}x\right) = -1, 0 \leq x \leq 2\pi:$$

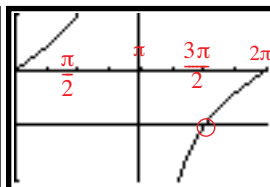
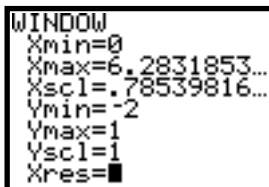
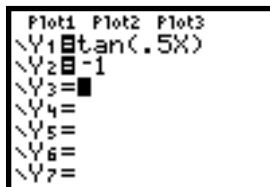

$$\therefore x = \frac{3\pi}{2}$$

$\tan\theta = -1, 0 \leq \theta \leq \pi:$

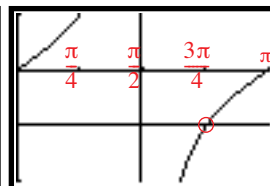
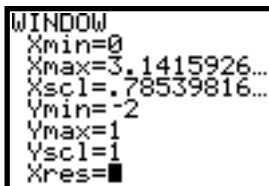
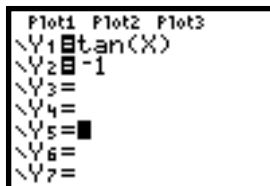

$$\begin{aligned}\theta &= \frac{3\pi}{4} \therefore \frac{1}{2}x = \frac{3\pi}{4} \\ \therefore x &= \frac{3\pi}{2}\end{aligned}$$

EXAMPLE 10.38

Solve $4 \sin(3x) = 2, 0^\circ \leq x \leq 360^\circ$

Solution

(a) $4 \sin(3x) = 2 \Leftrightarrow \sin(3x) = 0.5, 0^\circ \leq x \leq 360^\circ.$

Let $\theta = 3x \Rightarrow \sin \theta = 0.5.$

New domain: $0^\circ \leq x \leq 360^\circ \Leftrightarrow 0^\circ \leq \frac{\theta}{3} \leq 360^\circ \Leftrightarrow 0^\circ \leq \theta \leq 1080^\circ$

 Therefore, we have, $\sin \theta = 0.5, 0^\circ \leq \theta \leq 1080^\circ$

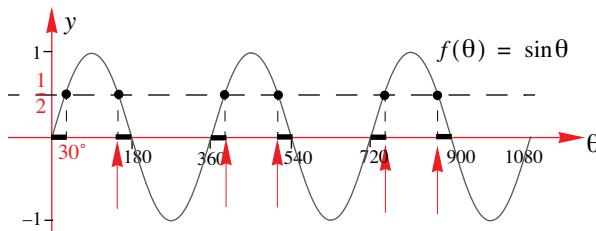
 The reference angle is 30° , then, by symmetry we have

$$\therefore \theta = 30^\circ, 180^\circ - 30^\circ, 360^\circ + 30^\circ, 540^\circ - 30^\circ, 720^\circ + 30^\circ, 900^\circ - 30^\circ$$

$$\therefore 3x = 30^\circ, 150^\circ, 390^\circ, 510^\circ, 750^\circ, 870^\circ$$

$$\therefore x = 10^\circ, 50^\circ, 130^\circ, 170^\circ, 250^\circ, 290^\circ$$

 All solutions lie within the **original** specified domain, $0^\circ \leq x \leq 360^\circ.$
EXAMPLE 10.39

Solve $2 \cos\left(\frac{x}{2} + \frac{\pi}{2}\right) - \sqrt{3} = 0$, for $-\pi \leq x \leq 4\pi.$

Solution

$$2 \cos\left(\frac{x}{2} + \frac{\pi}{2}\right) - \sqrt{3} = 0 \Leftrightarrow \cos\left(\frac{x}{2} + \frac{\pi}{2}\right) = \frac{\sqrt{3}}{2}, -\pi \leq x \leq 4\pi.$$

Let $\frac{x}{2} + \frac{\pi}{2} = \theta \Rightarrow \cos \theta = \frac{\sqrt{3}}{2}$

Next, $\frac{x}{2} + \frac{\pi}{2} = \theta \Leftrightarrow \frac{x}{2} = \theta - \frac{\pi}{2} \Leftrightarrow x = 2\theta - \pi.$ [Obtain x in terms of θ]

New domain: $-\pi \leq x \leq 4\pi \Leftrightarrow -\pi \leq 2\theta - \pi \leq 4\pi \Leftrightarrow 0 \leq 2\theta \leq 5\pi$

$$\Leftrightarrow 0 \leq \theta \leq \frac{5\pi}{2}$$

Therefore, our equivalent statement is .

$$\cos \theta = \frac{\sqrt{3}}{2}, 0 \leq \theta \leq \frac{5\pi}{2}$$

$$\therefore \theta = \frac{\pi}{6}, 2\pi - \frac{\pi}{6}, 2\pi + \frac{\pi}{6}$$

$$= \frac{\pi}{6}, \frac{11\pi}{6}, \frac{13\pi}{6}$$

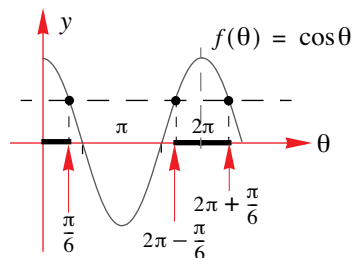
 But we still need to find the x -values:

Therefore, substituting $\theta = \frac{x}{2} + \frac{\pi}{2}$ back into the solution set, we have:

$$\begin{aligned} \frac{x}{2} + \frac{\pi}{2} &= \frac{\pi}{6}, \frac{11\pi}{6}, \frac{13\pi}{6} \\ \Leftrightarrow x + \pi &= \frac{\pi}{3}, \frac{11\pi}{3}, \frac{13\pi}{3} \\ \Leftrightarrow x &= -\frac{2\pi}{3}, \frac{8\pi}{3}, \frac{10\pi}{3} \end{aligned}$$

And, we notice that all solutions lie within the **original** specified domain, $-\pi \leq x \leq 4\pi$.

EXAMPLE 10.40

Solve the following, for $0 \leq x \leq 2\pi$.

- (a) $2 \sin x = 3 \cos x$ (b) $2 \sin 2x = 3 \cos x$ (c) $\sin x = \cos 2x$

Solution

(a) $2 \sin x = 3 \cos x \Leftrightarrow \frac{\sin x}{\cos x} = \frac{3}{2}, 0 \leq x \leq 2\pi$
 $\Leftrightarrow \tan x = 1.5, 0 \leq x \leq 2\pi$

The reference angle is $\text{Tan}^{-1}(1.5) \approx 0.9828$

Therefore, $x = \text{Tan}^{-1}(1.5), \pi + \text{Tan}^{-1}(1.5)$
 $\approx 0.9828, 4.1244$

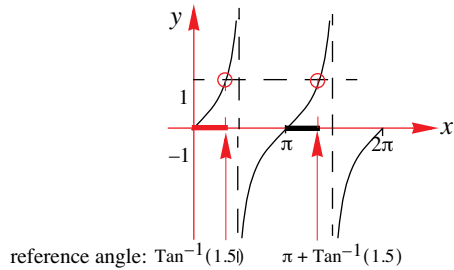

- (b) In this case we make use of the double angle identity, $\sin 2x = 2 \sin x \cos x$.

$$\begin{aligned} \therefore 2 \sin 2x &= 3 \cos x \Leftrightarrow 2(2 \sin x \cos x) = 3 \cos x \\ \Leftrightarrow 4 \sin x \cos x - 3 \cos x &= 0 \\ \Leftrightarrow \cos x(4 \sin x - 3) &= 0 \end{aligned}$$

$$\cos x = 0, \sin x = \frac{3}{4}$$

Solving for $\cos x = 0$: $x = \frac{\pi}{2}, \frac{3\pi}{2}$.

Solving for $\sin x = \frac{3}{4}$: $x = \text{Sin}^{-1}\left(\frac{3}{4}\right), \pi - \text{Sin}^{-1}\left(\frac{3}{4}\right)$

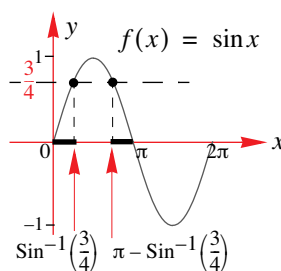
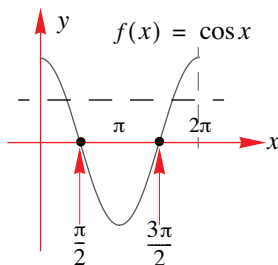

We solved two separate equations, giving the solution, $x = 0, \text{Sin}^{-1}\left(\frac{3}{4}\right), \frac{\pi}{2}, \pi - \text{Sin}^{-1}\left(\frac{3}{4}\right), \frac{3\pi}{2}$.

(c) This time we make use of the cosine double angle formula, $\cos 2x = 1 - 2\sin^2 x$.

$$\therefore \sin x = \cos 2x$$

$$\Leftrightarrow \sin x = 1 - 2\sin^2 x$$

$$\Leftrightarrow 2\sin^2 x + \sin x - 1 = 0$$

$$\Leftrightarrow (2\sin x - 1)(\sin x + 1) = 0$$

$$\Leftrightarrow \sin x = \frac{1}{2} \text{ or } \sin x = -1$$

Again, we have two equations to solve.

Solving for $\sin x = \frac{1}{2}$:

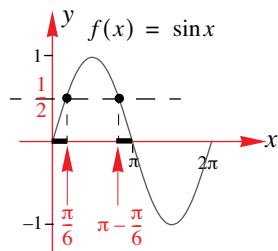

Solving for $\sin x = -1$:

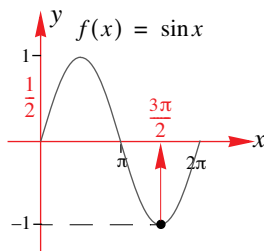

Therefore, solution set is $x = \frac{\pi}{6}, \frac{5\pi}{6}, \frac{3\pi}{2}$.

As the next example shows, the amount of working required to solve trigonometric equations can be significantly reduced, especially if you know the exact values (for the basic trigonometric angles) as well as the symmetry properties (without making use of a graph). However, we encourage you to use a visual aid when solving such equations.

EXAMPLE 10.41

Solve the equation $4 \sin x \cos x = \sqrt{3}$, $-2\pi \leq x \leq 2\pi$

S
o
l
u
t
i
o
n

$$4 \sin x \cos x = \sqrt{3}, -2\pi \leq x \leq 2\pi$$

$$2 \sin 2x = \sqrt{3} \text{ using } \sin 2\theta \equiv 2 \sin \theta \cos \theta$$

$$\sin 2x = \frac{\sqrt{3}}{2}$$

$$2x = \dots, \frac{-11\pi}{3}, \frac{-10\pi}{3}, \frac{-5\pi}{3}, \frac{-4\pi}{3}, \frac{\pi}{3}, \frac{2\pi}{3}, \frac{7\pi}{3}, \frac{8\pi}{3}, \dots$$

$$x = \frac{-11\pi}{6}, \frac{-5\pi}{3}, \frac{-5\pi}{6}, \frac{-2\pi}{3}, \frac{\pi}{6}, \frac{\pi}{3}, \frac{7\pi}{6}, \frac{4\pi}{3}$$

EXERCISES 10.5

1. If $0 \leq x \leq 2\pi$, find:

(a) $\sin x = \frac{1}{\sqrt{2}}$ (b) $\sin x = -\frac{1}{2}$ (c) $\sin x = \frac{\sqrt{3}}{2}$
 (d) $\sin 3x = \frac{1}{2}$ (e) $\sin\left(\frac{x}{2}\right) = \frac{1}{2}$ (f) $\sin(\pi x) = -\frac{\sqrt{2}}{2}$

2. If $0 \leq x \leq 2\pi$, find:

(a) $\cos x = \frac{1}{\sqrt{2}}$ (b) $\cos x = -\frac{1}{2}$ (c) $\cos x = \frac{\sqrt{3}}{2}$
 (d) $\cos\left(\frac{x}{3}\right) = \frac{1}{2}$ (e) $\cos(2x) = \frac{1}{2}$ (f) $\cos\left(\frac{\pi}{2}x\right) = -\frac{\sqrt{2}}{2}$

3. If $0 \leq x \leq 2\pi$, find:

(a) $\tan x = \frac{1}{\sqrt{3}}$ (b) $\tan x = -1$ (c) $\tan x = \sqrt{3}$
 (d) $\tan\left(\frac{x}{4}\right) = 2$ (e) $\tan(2x) = -\sqrt{3}$ (f) $\tan\left(\frac{\pi}{4}x\right) = -1$

4. If $0 \leq x \leq 2\pi$ or $0 \leq x \leq 360$, find:

(a) $\sin(x^\circ + 60^\circ) = \frac{1}{2}$ (b) $\cos(x^\circ - 30^\circ) = -\frac{\sqrt{3}}{2}$
 (c) $\tan(x^\circ + 45^\circ) = -1$ (d) $\sin(x^\circ - 20^\circ) = \frac{1}{\sqrt{2}}$
 (e) $\cos\left(2x - \frac{\pi}{2}\right) = \frac{1}{2}$ (f) $\tan\left(\frac{\pi}{4} - x\right) = 1$
 (g) $\sec(2x + \pi) = 2$ (h) $\cot\left(2x + \frac{\pi}{2}\right) = 1$

5. If $0 \leq x \leq 2\pi$ or $0 \leq x \leq 360$, find:

(a) $\cos x^\circ = \frac{1}{2}$ (b) $2\sin x + \sqrt{3} = 0$ (c) $\sqrt{3}\tan x = 1$
 (d) $5\sin x^\circ = 2$ (e) $4\sin^2 x - 3 = 0$ (f) $\frac{1}{\sqrt{3}}\tan x + 1 = 0$
 (g) $2\sin\left(x + \frac{\pi}{3}\right) = -1$ (h) $5\cos(x + 2) - 3 = 0$ (i) $\tan\left(x - \frac{\pi}{6}\right) = \frac{1}{\sqrt{3}}$
 (j) $2\cos 2x + 1 = 0$ (k) $\tan 2x - \sqrt{3} = 0$ (l) $2\sin x^\circ = 5\cos x^\circ$
 (m) $2\operatorname{cosec}\left(\frac{x}{2}\right) = 4$ (n) $\frac{1}{2}\cot(2x) = 0$ (o) $\sec\left(\frac{x}{3}\right) = -\sqrt{2}$

6. Solve the following equations for the intervals indicated, giving exact answers:

- (a) $\sin\theta\cos\theta = \frac{1}{2}, -\pi \leq \theta \leq \pi$ (b) $\cos^2\theta - \sin^2\theta = -\frac{1}{2}, -\frac{\pi}{2} \leq \theta \leq \frac{\pi}{2}$
 (c) $\tan A = \frac{1 - \tan^2 A}{2}, -\pi \leq A \leq \pi$ (d) $\frac{\sin\theta}{1 + \cos\theta} = -1, -\pi \leq \theta \leq \pi$
 (e) $\cos^2 x = 2\cos x, -\pi \leq x \leq \pi$ (f) $\sec 2x = \sqrt{2}, 0 \leq x \leq 2\pi$
 (g) $2\sin^2 x - 3\cos x = 2, 0 \leq x \leq 2\pi$ (h) $\sin 2x = 3\cos x, 0 \leq x \leq 2\pi$

7. Find (a) $3\tan^2 x + \tan x = 2, 0 \leq x \leq 2\pi$.

(b) $\tan^3 x + \tan^2 x = 3\tan x + 3, 0 \leq x \leq 2\pi$.

8. If $0 \leq x \leq 2\pi$ find:

(a) $\sin^2 2x - \frac{1}{4} = 0$ (b) $\tan^2\left(\frac{x}{2}\right) - 3 = 0$ (c) $\cos^2(\pi x) = 1$

9. If $0 \leq x \leq 2\pi$ find:

(a) $\sec^2 x + 2\sec x = 8$ (b) $\sec^2 x = 2\tan x + 4$
 (c) $\cot^2 x - \sqrt{3}\cot x = 0$ (d) $6\operatorname{cosec}^2 x = 8 + \cot x$

10. (a) Express $\sqrt{3}\sin x + \cos x$ in the form $R\sin(x + \alpha)$.

(b) Solve $\sqrt{3}\sin x + \cos x = 1, 0 \leq x \leq 2\pi$.

11. (a) Express $\sin x - \sqrt{3}\cos x$ in the form $R\sin(x + \alpha)$.

(b) Solve $\sin x - \sqrt{3}\cos x = -1, 0 \leq x \leq 2\pi$.

12. Find x if $2\sin\left(x + \frac{\pi}{3}\right) + 2\sin\left(x - \frac{\pi}{3}\right) = \sqrt{3}, 0 \leq x \leq 2\pi$.

13. (a) Sketch the graph of $f(x) = \sin x, 0 \leq x \leq 4\pi$.

(b) Hence, find i. $\left\{x \mid \sin x > \frac{1}{2}\right\} \cap \{x \mid 0 < x < 4\pi\}$.

ii. $\{x \mid \sqrt{3}\sin x < -1\} \cap \{x \mid 0 < x < 4\pi\}$.

14. (a) i. On the same set of axes sketch the graphs of $f(x) = \sin x$ and $g(x) = \cos x$ for $0 \leq x \leq 2\pi$.

ii. Find $\{x \mid \sin x < \cos x, 0 \leq x \leq 2\pi\}$.

(b) i. On the same set of axes sketch the graphs of $f(x) = \sin 2x$ and $g(x) = \cos x$ for $0 \leq x \leq 2\pi$.

ii. Find $\{x \mid \sin 2x < \cos x, 0 \leq x \leq 2\pi\}$.

MATHEMATICS – Higher Level (Core)

15. Show that $\{x : \sqrt{3} \cos x - \sin x = 1, x \in \mathbb{R}\} = \left\{x : x = 2n\pi + \frac{\pi}{6}\right\} \cup \left\{x : x = 2n\pi - \frac{\pi}{2}\right\}$,

where n is an integer.

16. Find (a) i. $\left\{x : \sin x = \sin \alpha, x \in \mathbb{R}, 0 < \alpha < \frac{\pi}{2}\right\}$.

ii. $\left\{x : \sin x \geq \sin \alpha, x \in \mathbb{R}, 0 < \alpha < \frac{\pi}{2}\right\}$

(b) $\{x : \sin 3x = \sin 2x, x \in \mathbb{R}\}$.

(c) $\{x : \cos 3x = \sin 2x, x \in \mathbb{R}\}$.

17. Given that the quadratic equation $x^2 - \sqrt{8} \cos \theta x + 3 \cos \theta = 1$ has equal roots, find

(a) $\theta, 0 \leq \theta \leq 2\pi$.

(b) the roots of the quadratic.

18. (a) Show that $\cos 3\theta = 4\cos^3\theta - 3\cos\theta$.

(b) Using the substitution $t = 2\cos\theta$, show that $t^3 = 3t + 1$ becomes $\cos 3\theta = \frac{1}{2}$.

(c) Hence find the exact values of the roots of the equation $x^3 - 3x - 1 = 0$.

19. Find $\{x \mid \cos x + \cos 2x + \cos 3x = 0, -\pi < x < \pi\}$

20. (a) Given that $2\sin 2x + \cos 2x = a$, show that $(1+a)\tan^2 x - 4\tan x + a = 1$.

(b) Hence, or otherwise show that if $\tan x_1$ and $\tan x_2$ are the roots of the quadratic in

(a), then $\tan(x_1 + x_2) = 2$

21. (a) Solve $\left\{x^\circ : 3\sin x^\circ - \frac{1}{\sin x^\circ} = 2, 0 \leq x \leq 360\right\}$

(b) Hence, find $\left\{x^\circ : 3\sin x^\circ < \frac{1}{\sin x^\circ} + 2, 0 \leq x \leq 360\right\}$.

22. Prove that if $0 < \alpha_1 < \alpha_2 < \dots < \alpha_n < \frac{\pi}{2}$, $\tan \alpha_1 < \frac{\sin \alpha_1 + \sin \alpha_2 + \dots + \sin \alpha_n}{\cos \alpha_1 + \cos \alpha_2 + \dots + \cos \alpha_n} < \tan \alpha_n$.

23. Using the inequality $\tan \frac{x}{2} > \frac{x}{2}$, prove that $\sin x > x - \frac{1}{4}x^3$, where $0 < x < \frac{\pi}{2}$.

24. Find all real values of x and y such that $\sin^4 x + \cos^4 y + 2 = 4\sin x \cos y$.

[Hint: let $u = \sin x, v = \cos y$ and show that $(u^2 - 1)^2 + (v^2 - 1)^2 + 2(u - v)^2 = 0$].

10.6 APPLICATIONS

Functions of the type considered in the previous section are useful for modelling periodic phenomena. These sorts of applications usually start with data that has been measured in an experiment. The next task is to find a function that ‘models’ the data in the sense that it produces function values that are similar to the experimental data. Once this has been done, the function can be used to predict values that are missing from the measured data (interpolation) or values that lie outside the experimental data set (extrapolation).

EXAMPLE 10.42

The table shows the depth of water at the end of a pier at various times (measured, in hours after midnight on the first day of the month.)

t (hr)	0	3	6	9	12	15	18	21	24	27	30	33
d (m)	16.20	17.49	16.51	14.98	15.60	17.27	17.06	15.34	15.13	16.80	17.42	15.89

Plot the data as a graph. Use your results to find a rule that models the depth data. Use your model to predict the time of the next high tide.

Solution

We start by entering the data as lists and then plotting them using the TI-83:

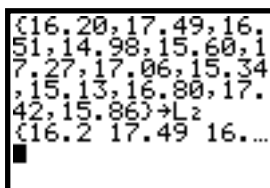
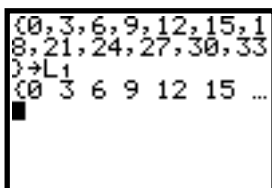

Using two different scales can provide graphs that do not really resemble each other.

Although both display a periodic nature, the second seems to reflect the need for a circular trigonometric function to model the behaviour.

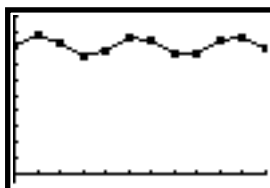
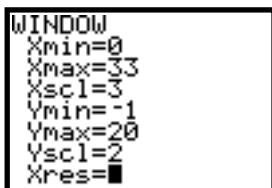
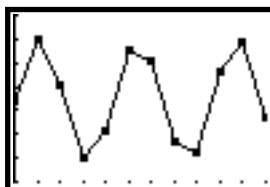
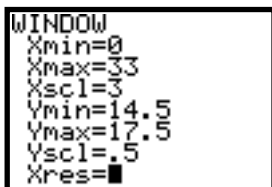

This does suggest that the depth is varying periodically. It appears that the period is approximately 13 hours. This is found by looking at the time between successive high tides. This is not as easy as it sounds as the measurements do not appear to have been made exactly at the high tides. This means that an estimate will need to be made based upon the observation that successive high tides appear to have happened after 3, 16 and 32 hours. Next, we look at the amplitude and vertical translation. Again, because we do not have exact readings at high and low tides, these will need to be estimated. The lowest tide recorded is 14.98 and the highest is 17.49.

A first estimate of the vertical translation is $\frac{17.49 + 14.98}{2} = 16.235$ and the amplitude is

MATHEMATICS – Higher Level (Core)

$17.7 - 16.235 = 1.465$. Since the graph starts near the mean depth and moves up it seems likely

that the first model to try might be: $y = 1.465 \times \sin\left(\frac{2\pi t}{13}\right) + 16.235$

Notice that the dilation factor (along the x -axis) is found by using the result that if

$$\tau = 13 \Rightarrow \frac{2\pi}{n} = 13 \therefore n = \frac{2\pi}{13}.$$

The model should now be ‘evaluated’ which means testing how well it fits the data. This can be done by making tables of values of the data and the values predicted by the model and working to make the differences between these as small as possible. This can be done using a scientific or graphics calculator.

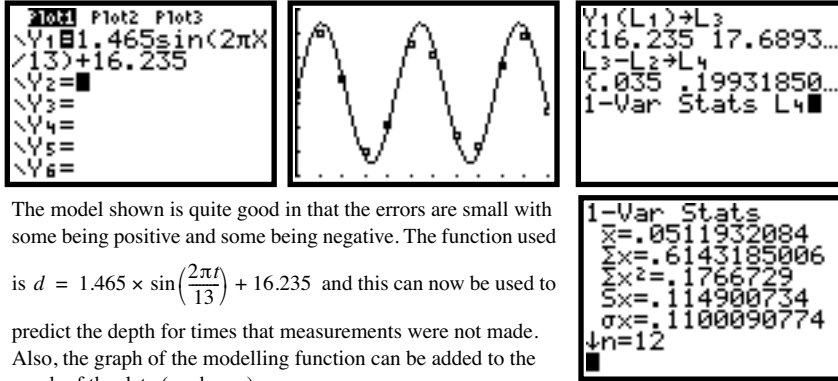

The model shown is quite good in that the errors are small with some being positive and some being negative. The function used

is $d = 1.465 \times \sin\left(\frac{2\pi t}{13}\right) + 16.235$ and this can now be used to

predict the depth for times that measurements were not made. Also, the graph of the modelling function can be added to the graph of the data (as shown).

The modelling function can also be used to predict depths into the future (extrapolation). The next high tide, for example can be expected to be 13 hours after the previous high tide at about 29.3 hours. This is after 42.3 hours.

EXAMPLE 10.43

During the summer months, a reservoir supplies water to an outer suburb

based on the water demand, $D(t) = 120 + 60 \sin\left(\frac{\pi}{90}t\right)$, $0 \leq t \leq 90$, where t measures the number of days from the start of Summer (which lasts for 90 days).

- Sketch the graph of $D(t)$.
- What are the maximum and minimum demands made by the community over this period?

S
o
l
u
t
i
o
n

- The features of this function are:

$$\text{Period} = \frac{2\pi}{\left(\frac{\pi}{90}\right)} = 180 \text{ days}$$

$$\text{Amplitude} = 60$$

$$\text{Translation} = 120 \text{ units up.}$$

We ‘pencil in’ the graph of $y = 60 \sin\left(\frac{\pi}{90}t\right)$

and then move it up 120 units:

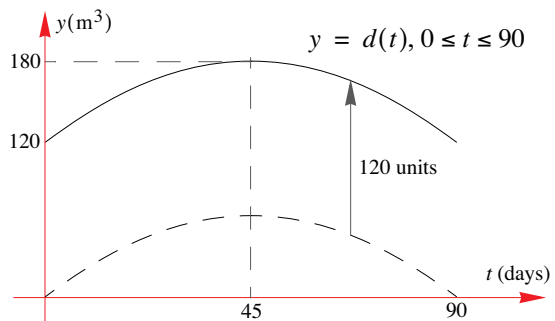

- (b) The minimum is 120 m^3 and the maximum is 180 m^3 .

EXAMPLE 10.44

When a person is at rest, the blood pressure, P millimetres of mercury at any time t seconds can be approximately modelled by the equation

$$P(t) = -20 \cos t \left(\frac{5\pi}{3} t \right) + 100, t \geq 0$$

- (a) Determine the amplitude and period of P .
 (b) What is the maximum blood pressure reading that can be recorded for this person?
 (c) Sketch the graph of $P(t)$, showing one full cycle.
 (d) Find the first two times when the pressure reaches a reading of 110 mmHg.

Solution

- (a) The amplitude is 20 mmHg and the period is given by $\frac{2\pi}{\left(\frac{5\pi}{3}\right)} = \frac{6}{5} = 1.2$ seconds.
 (b) The maximum is given by $(100 + \text{amplitude}) = 100 + 20 = 120$.
 (c) One full cycle is 1.2 seconds long:

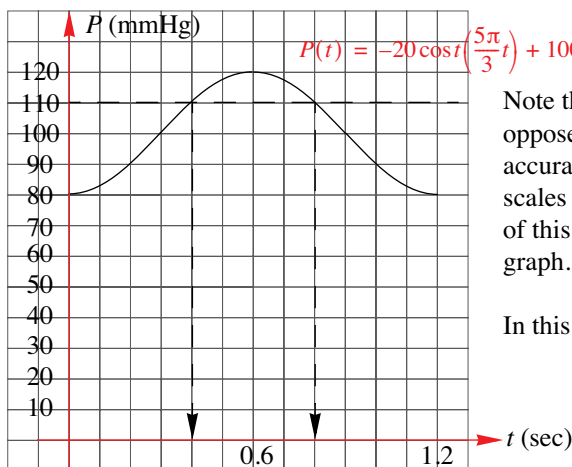

Note that the graph has been drawn as opposed to sketched. That is, it has been accurately sketched, meaning that the scales and the curve are accurate. Because of this we can read directly from the graph.

In this case, $P = 110$ when $t = 0.4$ and 0.8 .

- (d) Even though we have drawn the graph, we will now solve the relevant equation:

$$P(t) = 110 \Leftrightarrow 110 = -20 \cos \left(\frac{5\pi}{3} t \right) + 100$$

$$\Leftrightarrow 10 = 20 \cos \left(\frac{5\pi}{3} t \right)$$

$$\Leftrightarrow \cos \left(\frac{5\pi}{3} t \right) = -\frac{1}{2}$$

$$\therefore \frac{5\pi}{3} t = \pi - \text{Cos}^{-1} \left(\frac{1}{2} \right), \pi + \text{Cos}^{-1} \left(\frac{1}{2} \right) \quad \left[\text{Reference angle is } \text{Cos}^{-1} \left(\frac{1}{2} \right) = \frac{\pi}{3} \right]$$

$$\Leftrightarrow \frac{5\pi}{3} t = \frac{2\pi}{3}, \frac{4\pi}{3}$$

$$\Leftrightarrow t = \frac{2}{5}, \frac{4}{5}$$

EXERCISES 10.6

1. The table shows the temperature in an office block over a 36 hour period.

t (hr)	0	3	6	9	12	15	18	21	24	27	30	33	36
T °C	18.3	15.0	14.1	16.0	19.7	23.0	23.9	22.0	18.3	15.0	14.1	16.0	19.7

- (a) Estimate the amplitude, period, horizontal and vertical translations.
- (b) Find a rule that models the data.
- (c) Use your rule to predict the temperature after 40 hours.

2. The table shows the light level (L) during an experiment on dye fading.

t (hr)	0	1	2	3	4	5	6	7	8	9	10
L	6.6	4.0	7.0	10.0	7.5	4.1	6.1	9.8	8.3	4.4	5.3

- (a) Estimate the amplitude, period, horizontal and vertical translations.
- (b) Find a rule that models the data.

3. The table shows the value in \$s of an industrial share over a 20 month period.

Month	0	2	4	6	8	10	12	14	16	18	20
Value	7.0	11.5	10.8	5.6	2.1	4.3	9.7	11.9	8.4	3.2	2.5

- (a) Estimate the amplitude, period, horizontal and vertical translations.
- (b) Find a rule that models the data.

4. The table shows the population (in thousands) of a species of fish in a lake over a 22 year period.

Year	0	2	4	6	8	10	12	14	16	18	20	22
Pop	11.2	12.1	13.0	12.7	11.6	11.0	11.6	12.7	13.0	12.1	11.2	11.2

- (a) Estimate the amplitude, period, horizontal and vertical translations.
- (b) Find a rule that models the data.

5. The table shows the average weekly sales (in thousands of \$s) of a small company over a 15 year period.

Time	0	1.5	3	4.5	6	7.5	9	10.5	12	13.5	15
Sales	3.5	4.4	7.7	8.4	5.3	3.3	5.5	8.5	7.6	4.3	3.6

- (a) Estimate the amplitude, period, horizontal and vertical translations.
- (b) Find a rule that models the data.

6. The table shows the average annual rice production, P , (in thousands of tonnes) of a province over a 10 year period.

t (yr)	0	1	2	3	4	5	6	7	8	9	10
P	11.0	11.6	10.7	10.5	11.5	11.3	10.4	11.0	11.6	10.7	10.5

- (a) Estimate the amplitude, period, horizontal and vertical translations.
 (b) Find a rule that models the data.

- 7.** The table shows the depth of water (D metres) over a 5 second period as waves pass the end of a pier.

t (sec)	0	0.5	1	1.5	2	2.5	3	3.5	4	4.5	5
D	11.3	10.8	10.3	10.2	10.4	10.9	11.4	11.7	11.8	11.5	11.0

- (a) Estimate the amplitude, period, horizontal and vertical translations.
 (b) Find a rule that models the data.

- 8.** The population (in thousands) of a species of butterfly in a nature sanctuary is modelled by the function:

$$P = 3 + 2 \sin\left(\frac{3\pi t}{8}\right), 0 \leq t \leq 12$$

where t is the time in weeks after scientists first started making population estimates.

- (a) What is the initial population?
 (b) What are the largest and smallest populations?
 (c) When does the population first reach 4 thousand butterflies?

- 9.** A water wave passes a fixed point. As the wave passes, the depth of the water (D metres) at time t seconds is modelled by the function:

$$D = 7 + \frac{1}{2} \cos\left(\frac{2\pi t}{5}\right), t > 0$$

- (a) What are the greatest and smallest depths?
 (b) Find the first two times at which the depth is 6.8 metres.

- 10.** The weekly sales (S) (in hundreds of cans) of a soft drink outlet is modelled by the function:

$$S = 13 + 5.5 \cos\left(\frac{\pi t}{6} - 3\right), t > 0$$

t is the time in months with $t = 0$ corresponding to January 1st 1990,

- (a) Find the minimum and maximum sales during 1990.
 (b) Find the value of t for which the sales first exceed 1500 ($S = 15$).
 (c) During which months do the weekly sales exceed 1500 cans?

- 11.** The rabbit population, $R(t)$ thousands, in a northern region of South Australia is modelled by the equation $R(t) = 12 + 3 \cos\left(\frac{\pi}{6}t\right)$, $0 \leq t \leq 24$, where t is measured in months after the first of January.

- (a) What is the largest rabbit population predicted by this model?
 (b) How long is it between the times when the population reaches consecutive peaks?
 (c) Sketch the graph of $R(t)$ for $0 \leq t \leq 24$.
 (d) Find the longest time span for which $R(t) \geq 13.5$.
 (e) Give a possible explanation for the behaviour of this model.

MATHEMATICS – Higher Level (Core)

- 12.** A hill has its cross-section modelled by the function,

$$h : [0, 2] \rightarrow \mathbb{R}, h(x) = a + b \cos(kx),$$

where $h(x)$ measures the height of the hill relative to the horizontal distance x m from O.

- (a) Determine the values of
- k .
 - b .
 - a .
- (b) How far, horizontally from O, would an ant climbing this hill from O be, when it first reaches a height of 1 metre?
- (c) How much further, horizontally, will the ant have travelled when it reaches the same height of 1 metre once over the hill and on its way down?

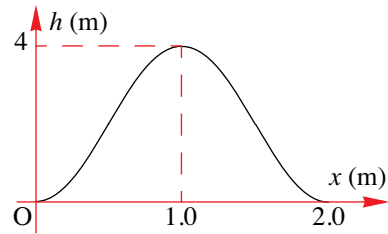

- 13.** A nursery has been infested by two insect pests: the Fruitfly and the Greatfly. These insects appear at about the same time that a particular plant starts to flower. The number of Fruitfly (in thousands), t weeks after flowering has started is modelled by the function

$$F(t) = 6 + 2 \sin(\pi t), 0 \leq t \leq 4.$$

Whereas the number of Greatfly (in thousands), t weeks after flowering has started is modelled by the function

$$G(t) = 0.25t^2 + 4, 0 \leq t \leq 4$$

- (a) Copy and complete the following table of values, giving your answers correct to the nearest hundred.

t	0	0.5	1	1.5	2	2.5	3	3.5	4
$F(t)$									
$G(t)$									

- (b) On the same set of axes **draw** the graphs of
- $F(t) = 6 + 2 \sin(\pi t), 0 \leq t \leq 4.$
 - $G(t) = 0.25t^2 + 4, 0 \leq t \leq 4.$
- (c) On how many occasions will there be equal numbers of each insect?
- (d) For what percentage of the time will there be more Greatflies than Fruitflies?

- 14.** The depth, $d(t)$ metres, of water at the entrance to a harbour at t hours after midnight on a particular day is given

$$d(t) = 12 + 3 \sin\left(\frac{\pi}{6}t\right), 0 \leq t \leq 24$$

- (a) Sketch the graph of $d(t)$ for $0 \leq t \leq 24.$
- (b) For what values of t will
- $d(t) = 10.5, 0 \leq t \leq 24.$
 - $d(t) \geq 10.5, 0 \leq t \leq 24.$

Boats requiring a minimum depth of b metres are only permitted to enter the harbour when the depth of water at the entrance of the harbour is at least b metres for a continuous period of one hour.

- (c) Find the largest value of b , correct to two decimal place, which satisfies this condition.

11.1 COMPLEX NUMBERS

11.1.1 INTRODUCTION

Complex numbers are often first encountered when solving a quadratic equation of the type for which there are no real solutions, e.g., $x^2 + 1 = 0$ or $x^2 + 2x + 5 = 0$ (because for both equations the discriminant, $\Delta = b^2 - 4ac$, is negative). However, the beginning¹ of complex numbers is to be found in the work of *Girolamo Cardano* (1501-1576), who was resolving a problem which involved the solution to a reduced cubic equation of the form

$x^3 + ax = b$, $a > 0$, $b > 0$. Although others later improved on the notation and the mechanics of complex algebra, it was the work found in his book, *Ars magna*, that led to the common usage of complex numbers found today.

11.1.2 Notation and $i^2 = -1$

The set of complex numbers is denoted by $C = \{z: z = x + iy, \text{ where } x, y \in R, i^2 = -1\}$. That is, a complex number, z , is ‘made up’ of two parts; ‘ x ’ and ‘ iy ’. The ‘ x -term’ is called the **real part** and the ‘ y -term’ is the **imaginary part** (i.e., the part attached to the ‘ i ’, where $i^2 = -1$). It is important to note the following:

1. The complex number $z = x + iy$ is a single number (even though there are ‘two parts’, it is still a single value).
2. **The real part** of z , denoted by $Re(z)$ is x . That is, $Re(z) = x$.
The imaginary part of z , denoted by $Im(z)$ is y . That is, $Im(z) = y$.

This means that the complex number z can be written as $z = Re(z) + Im(z)i$

Notice that the imaginary part is not ‘ iy ’ but simply ‘ y ’!

EXAMPLE 11.1

For each of the following complex numbers, state the real and imaginary parts of (a) $z = 2 + 3i$ (b) $w = 3 - 9i$

Solution

- (a) We have that $Re(z) = Re(2 + 3i) = 2$ and $Im(z) = Im(2 + 3i) = 3$.
Therefore, the real part of z is 2 and the imaginary part of z is 3.
- (b) Similarly, $Re(w) = Re(3 - 9i) = 3$ and $Im(w) = Im(3 - 9i) = -9$.
That is, the real part of w is 3 and the imaginary part of w is -9 .

EXAMPLE 11.2

If $z = 2xi + y^2 - 1$, find the values of x and y for which $Im(z) = 8$ and $Re(z) = 0$.

1. See *An Imaginary Tale, The Story of $\sqrt{-1}$* , by Paul J. Nahim.

S
o
l
u
t
i
o
n

We first need to determine what the real and imaginary parts of $z = 2xi + y^2 - 1$ are.

We have that $Im(z) = Im[(2x)i + (y^2 - 1)] = 2x$.

$$\therefore Im(z) = 8 \Leftrightarrow 2x = 8 \Leftrightarrow x = 4.$$

Similarly, $Re(z) = Re[(2x)i + (y^2 - 1)] = y^2 - 1$

$$\therefore Re(z) = 0 \Leftrightarrow y^2 - 1 = 0 \Leftrightarrow y = \pm 1.$$

11.1.3 USING THE TI-83 WITH COMPLEX NUMBERS

The TI-83 has the capability to work with complex numbers. There are three modes that can be used on TI-83:

Real : Real number form

a + bi : Rectangular-complex number form

re[^]θi : Polar-complex number form

To select the required form, press MODE and then use the arrow keys to select either the a + bi mode or the re[^]θi mode.

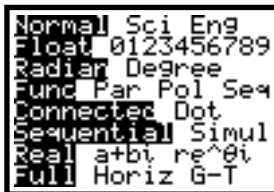

EXAMPLE 11.3

State the real and imaginary parts for each of the complex numbers

- (a) $z = -7 + 2i$ (b) $z = -3i$ (c) $z = 8$

S
o
l
u
t
i
o
n

After setting the graphic calculator to Rectangular-complex number form, we can make use of the complex (CPX) menu to help determine the complex and imaginary parts of the given numbers.



Press **MATH** and then use the arrow keys to move the cursor to **CPX**. Once that is done, select the required option(s), in this case, **real**(and **imag**(:

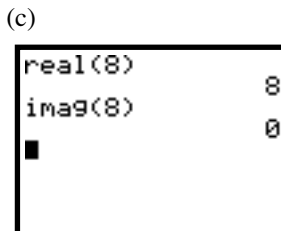
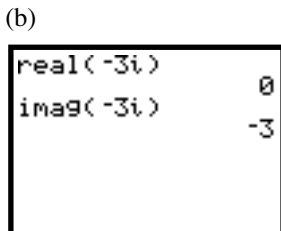
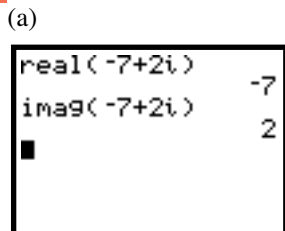

Notice: In (b), we have that $z = -3i = 0 - 3i$, and so, $Re(-3i) = Re(0 - 3i) = 0$.
In (c), we have that $z = 8 = 8 + 0i$, and so, $Im(8) = Im(8 + 0i) = 0$.

11.1.4 THE ALGEBRA OF COMPLEX NUMBERS

Working with ' i '

Since we have that $i = \sqrt{-1}$, then $i^2 = -1$.

Meaning that $i^3 = i^2 \times i = -1 \times i = -i$. Similarly, $i^4 = i^2 \times i^2 = -1 \times -1 = 1$, etc.

General results for expressions such as i^n can be determined. We leave this to the set of exercises at the end of this section.

Operations

For any two complex numbers $z_1 = a + ib$ and $z_2 = c + id$, the following hold true

Equality:

Two complex numbers are equal, if and only if their real parts are equal **and** their imaginary parts are equal.

That is,

$$z_1 = z_2 \Leftrightarrow a + ib = c + id \Leftrightarrow a = c \text{ and } b = d$$

Addition:

The sum of two (or more) complex numbers is made up of the sum of their real parts plus the sum of their imaginary parts (multiplied by ' i ').

That is,

$$z_1 + z_2 = (a + ib) + (c + id) = (a + c) + (b + d)i$$

Subtraction:

The difference of two (or more) complex numbers is made up of the difference of their real parts plus the difference of their imaginary parts (multiplied by ' i ').

That is,

$$z_1 - z_2 = (a + ib) - (c + id) = (a - c) + (b - d)i$$

Multiplication:

When multiplying two (or more) complex numbers, we complete the operation as we would with normal algebra. However, we use the fact that $i^2 = -1$ when simplifying the result.

That is,

$$z_1 z_2 = (a + ib)(c + id) = ac + adi + bci + bdi^2 = (ac - bd) + (ad + bc)i$$

Conjugate:

The conjugate of $z = x + iy$, denoted by \bar{z} or z^* is the complex number $z^* = x - iy$.

Note that $zz^* = (x + iy)(x - iy) = x^2 - xyi + xyi - y^2i^2 = x^2 + y^2$

That is, when a complex number is multiplied with its conjugate, the result is a real number.

$z = x + iy$ and $z^* = x - iy$ are known as **conjugate pairs**.

Division:

When dividing two complex numbers, we multiply the numerator and denominator by the conjugate of the denominator (this has the effect of 'realising' the denominator).

That is,
$$\frac{z_1}{z_2} = \frac{a+ib}{c+id} = \frac{a+ib}{c+id} \times \frac{c-id}{c-id} = \left(\frac{ac+bd}{c^2+d^2}\right) + \left(\frac{bc-ad}{c^2+d^2}\right)i$$

Note: It is important to realise that these results are not meant to be memorised. Rather, you should work through the multiplication or division in question and then simplify the result.

EXAMPLE 11.4

Find the values of x and y if $z = x + (y - 2)i$, $w = 4 + i$ and $z = w$.

**S
o
l
u
t
i
o
n**

Recall: Two complex numbers are equal if and only if their corresponding real parts and imaginary parts are equal.

So, $z = w \Leftrightarrow x + (y - 2)i = 4 + i \Leftrightarrow x = 4$ and $y - 2 = 1$.

That is, $z = w$ if and only if $x = 4$ and $y = 3$.

EXAMPLE 11.5

Find the value(s) of x if $z = (x - 2)^2 - 4xi$, $w = 9 + 4i$ and $z = w$.

**S
o
l
u
t
i
o
n**

Equating the real and imaginary parts, we have:

$$\begin{aligned} z = w &\Leftrightarrow (x - 2)^2 - 4xi = 9 + 4i \Leftrightarrow (x - 2)^2 = 9 \text{ and } -4x = 4. \\ &\Leftrightarrow x^2 - 4x + 4 = 9 \text{ and } x = -1 \\ &\Leftrightarrow x^2 - 4x - 5 = 0 \text{ and } x = -1 \\ &\Leftrightarrow (x - 5)(x + 1) = 0 \text{ and } x = -1 \\ &\Leftrightarrow x = 5 \text{ or } x = -1 \text{ and } x = -1 \end{aligned}$$

The only possible solution must be $x = -1$ (as it is the only common value for both real and imaginary parts that satisfies their equations simultaneously).

EXAMPLE 11.6

Find the real values x and y given that $(3 - 2i)(x + iy) = 12 - 5i$.

**S
o
l
u
t
i
o
n**

Again, as we are equating two complex numbers, we need to determine the simultaneous solution brought about by equating their real parts and imaginary parts:

From $(3 - 2i)(x + iy) = 12 - 5i$ we have $3x + 3yi - 2xi - 2yi^2 = 12 - 5i$

$$\Leftrightarrow (3x + 2y) + (3y - 2x)i = 12 - 5i$$

$$\Leftrightarrow 3x + 2y = 12 \text{ - Eq. 1. and } 3y - 2x = -5 \text{ - Eq. 2.}$$

Solving simultaneously, we have: $2 \times$ (Eq. 1.): $6x + 4y = 24$ - Eq. 3.

$$3 \times$$
 (Eq. 2.): $9y - 6x = -15$ - Eq. 4.

Adding, (Eq. 3.) + (Eq. 4.), we have: $13y = 9$

Therefore, $y = \frac{9}{13}$. Then, substituting into Eq. 1, we have:

$$3x + 2 \times \frac{9}{13} = 12 \Leftrightarrow 3x = \frac{138}{13} \Leftrightarrow x = \frac{46}{13}.$$

So, we have the solution pair, $x = \frac{46}{13}, y = \frac{9}{13}$.

EXAMPLE 11.7

Given that $z = 3 + i$ and $w = 1 - 2i$ evaluate the following:

- (a) $z + w$ (b) $2z - 3w$ (c) zw (d) w^2

Solution

- (a) $z + w = (3 + i) + (1 - 2i) = (3 + 1) + (1 - 2)i = 4 - i.$
 (b) $2z - 3w = 2(3 + i) - 3(1 - 2i) = 6 + 2i - 3 + 6i = 3 + 8i$
 (c) $zw = (3 + i)(1 - 2i) = 3(1 - 2i) + i(1 - 2i) = 3 - 6i + i - 2i^2 = 3 - 5i + 2 = 5 - 5i$
 (d) $w^2 = (1 - 2i)(1 - 2i) = 1 - 2i - 2i + 4i^2 = 1 - 4i - 4 = -3 - 4i$

The above operations can also be evaluated using the TI-83:

a., and b.

```
(3+i)+(1-2i) 4-i
2(3+i)-3(1-2i) 3+8i
```

c., and d.

```
(3+i)(1-2i) 5-5i
(1-2i)^2 -3-4i
```

EXAMPLE 11.8

Find the conjugate of (a) $z = 2 + 6i$ (b) $w = \sqrt{3}i - 1$

Solution

- (a) $z = 2 + 6i \Rightarrow z^* = \overline{2 + 6i} = 2 - 6i.$
 (b) $w = \sqrt{3}i - 1 \Rightarrow w^* = \overline{\sqrt{3}i - 1} = -\sqrt{3}i - 1.$

Using the TI-83, we have:

```
conj(2+6i) 2-6i
conj(sqrt(3)i-1) -1-1.732050808i
```

Notice that $\sqrt{3}$ is evaluated to a decimal approximation. So, although the TI-83 helps, because you are often asked to provide exact answers, you need to be able to do these problems without the aid of the TI-83.

EXAMPLE 11.9

Express the complex number $\frac{1-4i}{1+5i}$ in the form $u + iv$.

S
o
l
u
t
i
o
n

We first multiply the numerator and the denominator by $1 - 5i$. We use the conjugate of the denominator so that we can ‘realise’ the denominator:

$$\begin{aligned} \frac{1-4i}{1+5i} &= \frac{1-4i}{1+5i} \times \frac{1-5i}{1-5i} = \frac{1-5i-4i+20i^2}{1-5i+5i-25i^2} \\ &= \frac{1-9i-20}{1+25} \\ &= \frac{-19-9i}{26} \\ &= -\frac{19}{26} - \frac{9}{26}i \end{aligned}$$

Using the TI-83, we have:

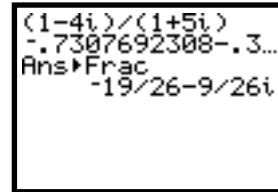

EXAMPLE 11.10

If $z = x + iy$, find (a) $z + z^*$ (b) $z - z^*$.

S
o
l
u
t
i
o
n

(a) $z + z^* = (x + iy) + (x - iy) = 2x = 2\text{Re}(z)$.

Note then, that $\text{Re}(z) = \frac{1}{2}(z + z^*)$.

(b) $z - z^* = (x + iy) - (x - iy) = 2yi = 2\text{Im}(z)i$

Note then, that $\text{Im}(z) = \frac{1}{2i}(z - z^*)$.

EXAMPLE 11.11

If $z = \cos \theta + i \sin \theta$ and $w = \sin \alpha + i \cos \alpha$ express zw in the form $p + qi$, where $p, q \in \mathbb{R}$. Hence find the maximum value of $p^2 + q^2$.

S
o
l
u
t
i
o
n

$$\begin{aligned} zw &= (\cos \theta + i \sin \theta)(\sin \alpha + i \cos \alpha) \\ &= \cos \theta \sin \alpha + \cos \theta \cos \alpha i + \sin \theta \sin \alpha i + \sin \theta \cos \alpha i^2 \\ &= \cos \theta \sin \alpha + \cos \theta \cos \alpha i + \sin \theta \sin \alpha i - \sin \theta \cos \alpha \\ &= (\cos \theta \sin \alpha - \sin \theta \cos \alpha) + (\cos \theta \cos \alpha + \sin \theta \sin \alpha)i \\ &= \sin(\alpha - \theta) + \cos(\alpha - \theta)i \end{aligned}$$

With $p = \sin(\alpha - \theta)$ and $q = \cos(\alpha - \theta)$ we have $p^2 + q^2 = \sin^2(\alpha - \theta) + \cos^2(\alpha - \theta) = 1$. As $p^2 + q^2$ will always have a fixed value of 1, its maximum value is also 1.

EXAMPLE 11.12Simplify the expression $\frac{\cos \beta + i \sin \beta}{\cos \beta - i \sin \beta}$.**S**
o
l
u
t
i
o
n

We start by realising the denominator: $\frac{\cos \beta + i \sin \beta}{\cos \beta - i \sin \beta} = \frac{\cos \beta + i \sin \beta}{\cos \beta - i \sin \beta} \times \frac{\cos \beta + i \sin \beta}{\cos \beta + i \sin \beta}$

$$= \frac{\cos^2 \beta + 2 \sin \beta \cos \beta i - \sin^2 \beta}{\cos^2 \beta + \sin^2 \beta}$$

$$= \frac{(\cos^2 \beta - \sin^2 \beta) + 2 \sin \beta \cos \beta i}{1}$$

$$= \cos 2\beta + \sin 2\beta i$$

EXERCISES 11.1

- Find (a) $Re(z)$ (b) $Im(z)$ (c) z^* for each of the following:
 - $z = 2 + 2i$
 - $z = -3 + \sqrt{2}i$
 - $z = -5i + 6$
 - $z = \frac{2}{5}i$
 - $z = \frac{3+i}{2}$
 - $2z = 1 - 3i - z$
- If $z = 4 - i$ and $w = 3 + 2i$, find in simplest form (i.e., expressed as $u + iv$), the following
 - $z + w$
 - $z - w$
 - z^2
 - $2z - 3w$
 - z^*w
 - iw
- If $z = 2 + i$ and $w = -3 + 2i$, find in simplest form (i.e., expressed as $u + iv$), the following
 - $z + w$
 - $z - w$
 - iz^2
 - $z^2 - i^2w$
 - $\bar{z}w$
 - $\bar{i}w$
- For the complex numbers $z = 1 - i$ and $w = 2i - 3$, express each of the following in the form $u + iv$:
 - $\frac{1}{z}$
 - $\frac{w}{z}$
 - $\frac{z+1}{i}$
 - z^{-2}
 - $\frac{2i}{w+3}$
 - $\frac{z^*}{w^*}$
- Simplify the following
 - $(2 + 4i)(3 - 2i)$
 - $(1 - i)^3$
 - $(1 + \sqrt{2}i)^2 i$
 - $\frac{i}{1 + 2i}$
 - $\frac{1 + 2i}{i}$
 - $\frac{(1 - i)i}{(-i + 2)}$

MATHEMATICS – Higher Level (Core)

- 6.** Given that $z = 3 + \sqrt{2}i$ and $w = \frac{1}{1-i}$, find
- (a) $Re(w)$ (b) $Im(zw)$ (c) $Re\left(\frac{z}{w}\right)$
- 7.** Find the real numbers x and y such that:
- (a) $2x + 3i = 8 - 6yi$ (b) $x + iy = (2 + 3i)^2$ (c) $(x + iy)(-i) = 5$
- 8.** (a) Simplify i^n for i. $n = 0, 1, 2, 3, 4, 5$
 ii. $n = -1, -2, -3, -4, -5$
- (b) Evaluate i. i^{10} ii. i^{15} iii. i^{90} iv. i^{74}
- 9.** Find the real numbers x and y , for which $(x + yi)(5 - 2i) = -18 + 15i$.
- 10.** Show that for any complex numbers $z = x + iy$ and $w = a + bi$,
- (a) $(z + w)^* = z^* + w^*$ (b) $(z - w)^* = z^* - w^*$
(c) $(zw)^* = z^*w^*$ (d) $(z^2)^* = (z^*)^2$
(e) $\left(\frac{z}{w}\right)^* = \frac{z^*}{w^*}$ (f) $(z^*)^* = z$
- 11.** (a) Prove that $z\bar{w} - \bar{z}w$ is purely imaginary or zero for all complex numbers z and w .
(b) Prove that $z\bar{w} + \bar{z}w$ is real for all complex numbers z and w .
- 12.** Given that $w = \frac{z-1}{\bar{z}+1}$, where $z = x + iy$, find the condition(s) under which
- (a) w is real (b) w is purely imaginary.
- 13.** (a) Find the real values of x and y , such that $(x + iy)^2 = 8 - 6i$.
Hence, determine $\sqrt{8 - 6i}$, expressing your answer in the form $u + iv$, where u and v are both real numbers and $u > 0$.
(b) Find $\sqrt{3 - 4i}$, expressing your answer in the form $u + iv$, where u and v are both real numbers and $u > 0$.
- 14.** Simplify the following
- (a) $(1 + i)^3 - (1 - i)^3$ (b) $(1 + i)^3 + (1 - i)^3$ (c) $\frac{(1 + i)^3}{(1 - i)^3}$
- 15.** Find the real values x and y for which
- (a) $(x - y) + 4i = 9 + yi$. (b) $(2x + 3y) - x^3i = 12 - 64i$.
- 16.** Find the complex number z given that $5z + 2i = 5 + 2iz$, giving your answer in the form $a + ib$, where a and b are real.
- 17.** Find the complex number z which satisfies the equation $z(1 + \sqrt{2}i) = 1 - \sqrt{2}i$.

- 18.** The complex number z satisfies the equation $z^2 - i = 2z - 1$. If $z = u + iv$ find all real values of u and v .
- 19.** If $z = \frac{2-i}{1+i}$, find (a) $Re(z^2) + Im(z^2)$ (b) $Re\left(z + \frac{1}{z}\right) + Im\left(z + \frac{1}{z}\right)$
- 20.** (a) Show that i. $\frac{1+i}{1-i} = i$. ii. $\left(\frac{1+i}{1-i}\right)^2 = -1$
 (b) Show that $\left(\frac{1+i}{1-i}\right)^{4k} = 1$ if k is a positive integer.
- 21.** Find the complex number(s) $z = a + bi$, satisfying the equation $\frac{1+z^2}{1-z^2} = i$.
- 22.** Express the following in the form $p + qi$, where p and q are real numbers.
 (a) $(\cos \theta + i \sin \theta)(\cos \alpha + i \sin \alpha)$
 (b) $(\cos \theta + i \sin \theta)(\cos \alpha - i \sin \alpha)$
 (c) $(r_1 \cos \theta + ir_1 \sin \theta)(r_2 \cos \alpha + ir_2 \sin \alpha)$
 (d) $(x - \cos \theta - i \sin \theta)(x - \cos \theta + i \sin \theta)$
 (e) $(x + \sin \alpha + i \cos \alpha)(x + \sin \alpha - i \cos \alpha)$
- 23.** For the complex number defined as $z = \cos(\theta) + i \sin(\theta)$, show that
 (a) $z^2 = \cos(2\theta) + i \sin(2\theta)$ (b) $z^3 = \cos(3\theta) + i \sin(3\theta)$
 Assuming now that $z^k = \cos(k\theta) + i \sin(k\theta)$, show that
 (c) $C + i(S - 1) = \frac{1 - z^n}{1 - z}$, where $C = 1 + \cos(\theta) + \cos(2\theta) + \dots + \cos((n-1)\theta)$
 and $S = 1 + \sin(\theta) + \sin(2\theta) + \dots + \sin((n-1)\theta)$, where $0 < \theta < \frac{\pi}{2}$.
- 24.** (a) Given that $(x + iy)^2 = 8 + 6i$, find the values of x and y . Hence, find $\sqrt{8 + 6i}$.
 (b) If $(2 + 3i)(3 - 4i) = p + qi$, find the value of $p^2 + q^2$.
 (c) If $(x + iy)^2 = a + ib$, find an expression for $a^2 + b^2$ in terms of x and y .
- 25.** The equation $z + b + i(z - 4) = 0$, where b is a real number, has as its solution a real number. Determine this solution and hence determine the value of b .
- 26.** Express the following in the form $a + bi$ where a and b are real numbers.
 (a) $\frac{\cos 2\theta + i \sin 2\theta}{\cos \theta + i \sin \theta}$ (b) $\frac{\cos \theta + i \sin \theta}{\cos 3\theta - i \sin 3\theta}$

27. Let the complex matrix $A = \begin{bmatrix} \alpha i & 0 \\ 0 & -\beta i \end{bmatrix}$. Find

- (a) A^2 (b) A^4 (c) A^{-1} (d) A^{4n} , where n is a positive integer.

28. (a) Find $\frac{dy}{d\theta}$ given that $y = \cos\theta + i\sin\theta$.

- (b) Show i. that $i \cdot \frac{d\theta}{dy} = \frac{1}{y}$. ii. when $\theta = 0, y = 1$.

(c) Hence show that $e^{i\theta} = \cos\theta + i\sin\theta$.

(d) Deduce an expression for $e^{-i\theta}$.

- (e) Hence, show that i. $\cos x = \frac{1}{2}(e^{ix} + e^{-ix})$. ii. $\sin x = \frac{1}{2i}(e^{ix} - e^{-ix})$.

11.2

GEOMETRICAL REPRESENTATION OF COMPLEX NUMBERS

11.2.1 THE ARGAND DIAGRAM

Unlike real numbers (which can be described geometrically by the position they occupy on a one dimensional number line), complex numbers require the real and imaginary parts to be described. The geometrical representation best suited for this purpose would be 2- dimensional. Any complex number $z = x + iy$ may be represented on an **Argand diagram**, either by using

- the point $P(x, y)$, or
- the position vector \vec{OP}

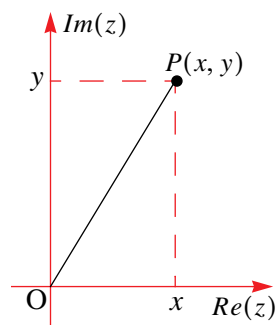

That is, we make use of a plane that is similar to the standard Cartesian plane, to represent the complex number $z = x + iy$. This means that the x -axis represents the $Re(z)$ value and the y -axis represents the $Im(z)$ value.

EXAMPLE 11.13

Represent each of the following complex numbers on an Argand diagram

- (a) $z = 1 + 3i$ (b) $z = -2 + i$ (c) $z = -2i$

S
O
L
O
L
I
T
I
O
N

- (a) With $z = 1 + 3i$, we have $x = Re(z) = 1$ and $y = Im(z) = 3$. Therefore, we may represent the complex number $z = 1 + 3i$ by the point $P(1,3)$ on the Argand diagram:

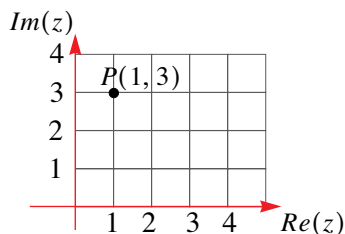

Similarly for (b) and (c) we have:

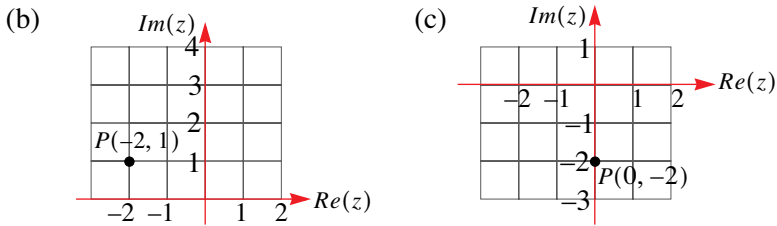

11.2.2 GEOMETRICAL PROPERTIES OF COMPLEX NUMBERS

The modulus of z

The modulus of a complex number $z = x + iy$ is a measure of the length of $z = x + iy$ and is denoted by $|z|$. That is, $mod(z) = |z|$.

The **modulus** of z is also called the **magnitude** of z . We can determine the length by using Pythagoras's theorem:

$$(OP)^2 = x^2 + y^2$$

$$\therefore OP = \sqrt{x^2 + y^2}$$

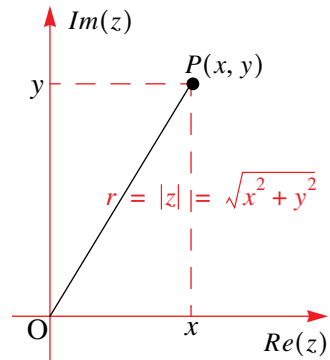

That is, if $z = x + iy$ then, $mod(z) = |z| = \sqrt{x^2 + y^2}$.

The modulus of z is also written as r , i.e., $r = |z|$.

Notice then, that $|z| = \sqrt{x^2 + y^2} = \sqrt{z^*z}$

The Argument of z

The **argument** of a complex number $z = x + iy$ is a measure of the angle which $z = x + iy$ makes with the **positive** $Re(z)$ – axis and is denoted by $arg(z)$ and sometimes by $ph(z)$, which stands for the **phase** of z . If θ is this angle, we then write, $\theta = arg(z)$.

If $-\pi < \theta \leq \pi$, then $\theta = Arg(z)$

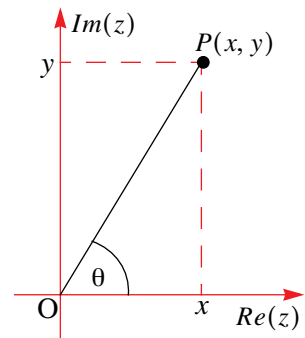

Notice the use of capital 'A' rather than lower case 'a'. Using $\theta = Arg(z)$, implies that we are referring to the **Principal argument value**, that is, we have restricted the range in which the angle θ lies.

EXAMPLE 11.14

Find the modulus of the following complex numbers

- (a) $z = 4 + 3i$ (b) $z = -1 + 2i$

S
o
l
u
t
i
o
n

(a) $z = 4 + 3i \therefore |z| = \sqrt{(4)^2 + (3)^2} = \sqrt{25} = 5$

Notice that we only square the real and imaginary parts of the complex number. That is, we **do not use** $3i$ because this would give $\sqrt{(4)^2 + (3i)^2} = \sqrt{16 - 9} = \sqrt{7}!$

(b) In the same way we have: $z = -1 + 2i \therefore |z| = \sqrt{(-1)^2 + (2)^2} = \sqrt{5}.$

EXAMPLE 11.15

Find the principal argument of the following complex numbers

- (a) $z = 1 + i$ (b) $z = -1 + 2i$ (c) $-1 - \sqrt{3}i$

S
o
l
u
t
i
o
n

When finding the principal argument of a complex number, an Argand diagram can be used as an aid. This will always enable us to work with right-angled triangles. Then we can make use of the diagram to find the restrictions on the required angle, i.e., $-\pi < \theta \leq \pi$, then $\theta = \text{Arg}(z)$.

- (a) We first represent $z = 1 + i$ on an Argand diagram:

From the triangle OPM, we have that

$$\tan \theta = \frac{PM}{OM} = \frac{1}{1}$$

$$\therefore \theta = \text{Tan}^{-1}(1)$$

$$\Rightarrow \theta = \frac{\pi}{4} \text{ (or } 45^\circ)$$

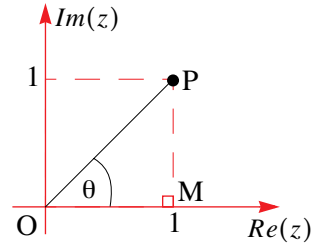

Therefore, the principal argument of z , is $\text{Arg}(z) = \frac{\pi}{4}$.

- (b) Again, we start by using an Argand diagram:

From the triangle OPM, we have that

$$\tan \alpha = \frac{PM}{OM} = \frac{2}{1}$$

$$\therefore \alpha = \text{Tan}^{-1}(2)$$

$$\Rightarrow \alpha = 63^\circ 26'$$

Therefore, $\theta = 180 - 63^\circ 26' = 116^\circ 34'.$

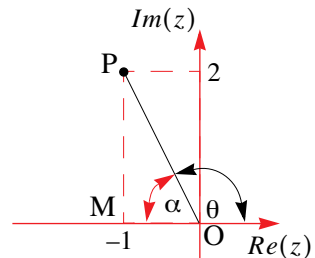

So that (the principal argument) $\text{Arg}(z) = 116^\circ 34'.$

Notice that we only make use of α to help us determine θ [i.e., $\alpha + \theta = \pi$ (or 180°)]

(c) From the triangle OPM, we have that

$$\tan \alpha = \frac{PM}{OM} = \frac{\sqrt{3}}{1}$$

$$\therefore \alpha = \text{Tan}^{-1}(\sqrt{3})$$

$$\Rightarrow \alpha = 60^\circ$$

Therefore, $\theta = 180 - 60^\circ = 120^\circ$.

So that (the principal argument) $\text{Arg}(z) = -120^\circ$

Notice that because we are ‘moving’ in a **clockwise direction**, the **angle is negative**.

Notice that in the last example, although $\text{Arg}(z) = -120^\circ$, we could have written $\text{arg}(z) = 180^\circ + 60^\circ = 240^\circ$ (using ‘small’ ‘a’).

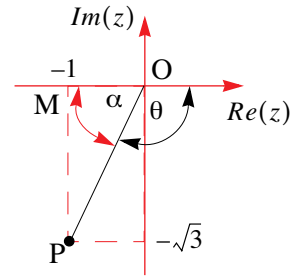

Using the TI-83

The TI-83 has the capability to evaluate the angle; **angle(**, and the modulus; **abs(**, of a complex number expressed in **rectangular form** (i.e., expressed in the form $z = x + iy$).

angle(

There are two angle settings in the MODE menu, the default setting is in radian mode, whilst the second answer is in degree mode:

For $z = 1 + i$

```
angle(1+i)
.7853981634
angle(1+i)
45
```

For $z = -1 - \sqrt{3}i$

```
angle(-1-√(3)i)
-2.094395102
angle(-1-√(3)i)
-120
```

abs(

The absolute value function returns the magnitude (or modulus) of a complex number:

For $z = 1 + i$

```
abs(1+i)
1.414213562
```

For $z = -1 - \sqrt{3}i$

```
abs(-1-√(3)i)
2
```

EXAMPLE 11.16

If $z = 1 + 2i$ and $w = x - i$, find

(a) $|z + 4|$

(b) $|z + w|$

Find the minimum value of $|z + w|$.

Solution

(a) First, we need to determine the complex number $z + 4$:

$$z + 4 = (1 + 2i) + 4 = 5 + 2i.$$

$$\text{Then we have, } |5 + 2i| = \sqrt{25 + 4} = \sqrt{29}$$

(b) First, we need to determine the complex number $z + w$:

$$\begin{aligned} z + w &= (1 + 2i) + (x - i) = (x + 1) + i \therefore |(x + 1) + i| = \sqrt{(x + 1)^2 + 1} \\ &= \sqrt{x^2 + 2x + 2} \end{aligned}$$

MATHEMATICS – Higher Level (Core)

Now, $\sqrt{x^2 + 2x + 2} = \sqrt{(x^2 + 2x + 1) + 1} = \sqrt{(x + 1)^2 + 1}$. The minimum value will occur when $(x + 1)^2 + 1$ is a minimum. But, the minimum value of $(x + 1)^2 + 1$ is 1, therefore the minimum of $\sqrt{(x + 1)^2 + 1}$ is $\sqrt{1} = 1$.

Adding complex numbers - geometric representation

The addition of two complex numbers $z_1 = x_1 + iy_1$ and $z_2 = x_2 + iy_2$ can be considered in the same way as the addition of two vectors. That is, if $z_1 = x_1 + iy_1$ and $z_2 = x_2 + iy_2$ are represented by directed line segments from the origin $0 + 0i$ their sum, $(x_1 + x_2) + (y_1 + y_2)i$ can also be represented by a directed line segment from the origin $0 + 0i$.

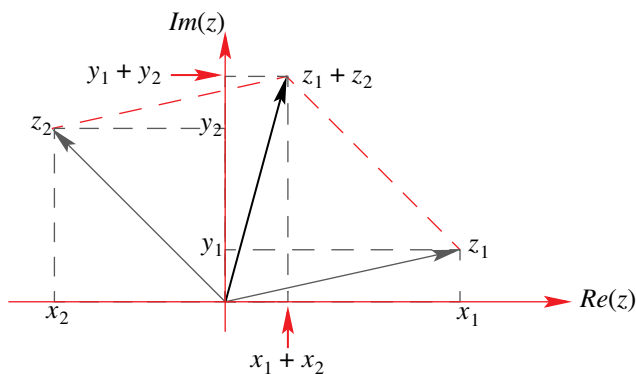

e.g., if $z_1 = 6 + 2i$ and $z_2 = -4 + 4i$ then $z_1 + z_2 = 2 + 6i$

Subtracting complex numbers - geometric representation

Subtracting two complex numbers $z_1 = x_1 + iy_1$ and $z_2 = x_2 + iy_2$ can be considered in the same way as subtracting two vectors. That is, if $z_1 = x_1 + iy_1$ and $z_2 = x_2 + iy_2$ are represented by directed line segments from the origin $0 + 0i$. Subtracting z_2 from z_1 , i.e., $z_1 - z_2$ we obtain $(x_1 - x_2) + (y_1 - y_2)i$ which can also be represented by a directed line segment from the origin $0 + 0i$.

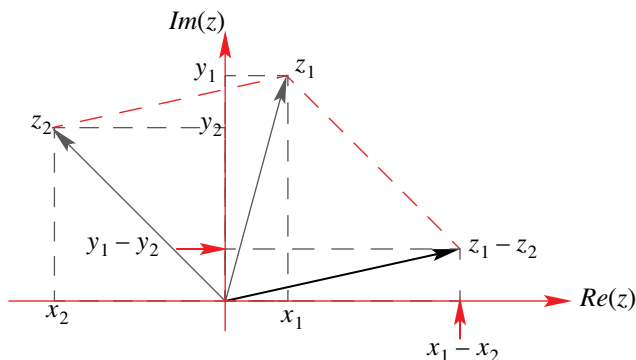

e.g., if $z_1 = 2 + 6i$ and $z_2 = -4 + 4i$ then $z_1 - z_2 = 6 + 2i$

The similarities between complex numbers and vectors in two dimensions (see Chapter 26) make much of the theory interchangeable. Often, complex numbers are represented by the same notation as used in vector theory. For example, if the point P on the Argand diagram represents the complex number $z = 2 + 3i$ then the vector $\overrightarrow{OP} = [2, 3]$ would represent the same point. However, at this stage we will concentrate on features that deal directly with the complex numbers field.

Properties of the modulus function

We summarise a number of important properties of the modulus function and leave their proofs as exercises.

1. Addition

i. If $z, w \in C$, then $|z + w| \leq |z| + |w|$

ii. If $z_1, z_2, \dots, z_n \in C$, then $|z_1 + z_2 + \dots + z_n| \leq |z_1| + |z_2| + \dots + |z_n|$

2. Subtraction

If $z, w \in C$, then $|z - w| \geq |z| - |w|$

3. Product

i. If $z, w \in C$, then $|z \times w| = |z| \times |w|$

ii. If $z_1, z_2, \dots, z_n \in C$, then $|z_1 \times z_2 \times \dots \times z_n| = |z_1| \times |z_2| \times \dots \times |z_n|$

iii. If $z_1, z_2, \dots, z_n \in C$, and $z_1 = z_2 = \dots = z_n$ then $|z_1 \times z_2 \times \dots \times z_n| = |z| ^n$

4. Quotient

If $z, w \in C$, then $\left| \frac{z}{w} \right| = \frac{|z|}{|w|}$, $w \neq 0$

5. Conjugate

If $z \in C$, then $|z| = |z^*|$

6. Negation

If $z \in C$, then $|-z| = |-1 \times z| = |-1| \times |z| = |z|$

Observations of the argument function

We now consider a number of examples that will reveal some properties of the argument function as well as cautions when using $\arg(z)$ as opposed to $\text{Arg}(z)$.

EXAMPLE 11.17

For the complex numbers $z = 1 + i$ and $w = 1 + \sqrt{3}i$ find:

- (a) $Arg(z)$
- (b) $Arg(w)$
- (c) $Arg(zw)$

S Although, we should be drawing an Argand diagram to help us determine the principal arguments, we will use the TI-83 as an aid to help us ‘discover’ some properties about the argument function.

- (a) For $z = 1 + i$, we have $Arg(z) = 45^\circ$
- (b) For $w = 1 + \sqrt{3}i$, then $Arg(w) = 60^\circ$
- (c) Finally, we have that $Arg(zw) = 105^\circ$
We notice that $45^\circ + 60^\circ = 105^\circ$
So, **in this case** we have that

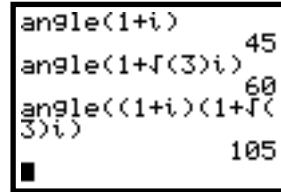

$$Arg(zw) = Arg(z) + Arg(w)$$

Notice that if $Arg(z) + Arg(w) \notin (-\pi, \pi]$, we would need to draw a diagram to determine the corresponding angle that lies in the region $(-\pi, \pi]$. On the other hand, if all we wanted was $arg(zw)$, then whatever answer we determine will be acceptable (because $arg(zw)$ does not need to be in the interval $(-\pi, \pi]$).

EXAMPLE 11.18

For the complex numbers $z = -1 + i$ and $w = 1 + \sqrt{3}i$ find $Arg(zw)$

S As in the previous example, we use the TI-83 to help us with the calculations.

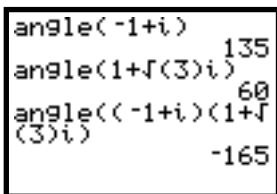

This time we see that $Arg(z) + Arg(w) = 135^\circ + 60^\circ = 195^\circ \neq Arg(zw)$.

What we do have is, $arg(z) + arg(w) = 195^\circ = arg(zw)$.

But the angle corresponding to 195° which lies in the interval $(-\pi, \pi]$ is in fact -165° (as seen in the diagram).

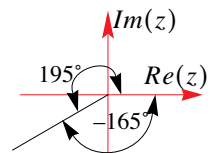

- And so, we have that
1. $arg(zw) = arg(z) + arg(w)$ **[always]**
 2. $Arg(zw) = Arg(z) + Arg(w)$ **[sometimes]**

In the same way we can find results for when complex numbers are divided.

Properties of the argument function

If $\arg(z_1) = \theta_1$, $\arg(z_2) = \theta_2$, $\arg(z_3) = \theta_3$, ..., $\arg(z_n) = \theta_n$, then:

1. Multiplication

i. $\arg(z_1 z_2) = \arg(z_1) + \arg(z_2) = \theta_1 + \theta_2$

ii.
$$\begin{aligned} \arg(z_1 z_2 \dots z_n) &= \arg(z_1) + \arg(z_2) + \dots + \arg(z_n) \\ &= \theta_1 + \theta_2 + \dots + \theta_n \end{aligned}$$

iii. $\arg(z_1^n) = n \times \arg(z_1)$

$$\text{i.e., } \arg(z_1^n) = \arg(\underbrace{z_1 \times z_1 \times \dots \times z_1}_{n \text{ times}}) = \underbrace{\theta_1 + \theta_1 + \dots + \theta_1}_{n \text{ times}} = n\theta_1$$

2. Division

i. $\arg\left(\frac{z_1}{z_2}\right) = \arg(z_1) - \arg(z_2)$

ii. $\arg\left(\frac{1}{z_2}\right) = -\arg(z_2)$

3. Conjugate

$$\arg(z_1^*) = -\arg(z_1) = -\theta_1$$

BEWARE! The above rules do not necessarily hold when finding the Principal Argument. It should also be noted that **$\arg(0)$ is undefined.**

EXAMPLE 11.19

Find $\text{Arg}\left(\frac{z^2}{w^3}\right)$ if $z = 1 - i$ and $w = -\sqrt{3} + i$

S
o
l
u
t
i
o
n

Using the properties for the division of two complex numbers we have:

1. $\arg\left(\frac{z^2}{w^3}\right) = \arg(z^2) - \arg(w^3)$.

Then, using the power properties we have:

2. $\arg\left(\frac{z^2}{w^3}\right) = \arg(z^2) - \arg(w^3) = 2\arg(z) - 3\arg(w)$.

We next determine $\arg(z)$ and $\arg(w)$

Using the TI-83, with the mode setting to degrees we can determine the angles. We can then convert to radians.

```
angle(1-i)      -45
angle(-sqrt(3)+i) 150
```

So, we have $\arg(z) = -45^\circ$ and $\arg(w) = 150^\circ$.
 Therefore, $2\arg(z) - 3\arg(w) = -90^\circ - 450^\circ = -540^\circ$
 i.e., $\arg\left(\frac{z^2}{w^3}\right) = -540^\circ$.

To work out the principal value, $Arg\left(\frac{z^2}{w^3}\right)$ we use a diagram and see that -540° corresponds to -180° or 180° . But, as we want the principal value we must use 180° . So, $Arg\left(\frac{z^2}{w^3}\right) = 180^\circ$ (or π).

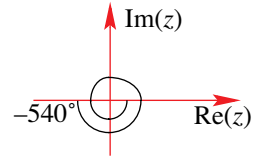

EXERCISES 11.2

- Show the following complex numbers on an Argand diagram:

(a) $2 + i$ (b) $-6i$ (c) $4 - 3i$ (d) $2(1 - i)$
 (e) $-3(1 - i)$ (f) $(1 + 2i)^2$ (g) $\frac{1}{2i}$ (h) $\frac{2}{1 + i}$
- For the complex number $z = 1 + i$, represent the following on an Argand diagram:

(a) i. zi ii. zi^2 iii. zi^3 iv. zi^4

What is the geometrical effect of multiplying a complex number by i ?

(b) i. z^* ii. $z + z^*$ iii. $z - z^*$

Describe the geometrical significance of each of the operations in part b.
- If $z_1 = 1 + 2i$ and $z_2 = 1 + i$, show each of the following on an Argand diagram:

(a) z_1^2 (b) $\frac{1}{z_2}$ (c) z_1z_2 (d) $2z_1 - z_2$
 (e) $\overline{z_1z_2}$ (f) $\overline{z_1} + \overline{z_2}$ (g) $\frac{z_1}{z_2}$ (h) $\frac{z_2}{z_1}$
- Find the modulus and argument of:

(a) $1 + \sqrt{3}i$ (b) $1 - \sqrt{3}i$ (c) $1 + \sqrt{2}i$ (d) $3i$
 (e) $-\frac{1}{2} - \frac{\sqrt{3}}{2}i$ (f) $\frac{1}{\sqrt{2}}(i + 1)$ (g) 6 (h) $\left(1 - \frac{1}{2}i\right)^2$
- Consider the two complex numbers $z = a + bi$ and $w = -a + bi$.

(a) Find $|z|$, $|w|$, $|zw|$
 (b) Find i. $Arg(z + w)$ ii. $Arg(z - w)$

- 6.** If $z = (x-3) + i(x+3)$, find i. $|z|$ ii. $\{x: |z|=6\}$
- 7.** If $z = 2 + i$ and $w = -1 - i$, verify the following
- $|z|^2 = zz^*$
 - $|zw| = |z||w|$
 - $|w^3| = |w|^3$
 - $|z+w| \leq |z| + |w|$
 - $Arg(zw) = Arg(z) + Arg(w)$
- What is the geometrical significance of part d.?
- 8.** If $w = \frac{z+1}{z-1}$ and $|z| = 1$, find $Re(w)$.
- 9.** Given that $|w| = 5$, find (a) $|-3w|$ (b) $|\bar{w}|$ (c) $|2iw|$.
- 10.** If $Arg(z) = 0$, show that z is real and positive.
- 11.** A complex number w is such that w is purely imaginary, show that $Arg(w) = \pm \frac{\pi}{2}$.
- 12.** (a) If $arg(z) = \frac{\pi}{6}$ and $z = x + iy$, show that $\sqrt{3}y = x$.
 (b) Find z if $|z-1| = 1$ and $arg(z-i) = 0$.
- 13.** (a) If the complex number z satisfies the equations $arg(z+1) = \frac{\pi}{6}$ and $arg(z-1) = \frac{2\pi}{3}$, show that $z = \frac{1}{2}(1 + \sqrt{3}i)$.
 (b) If w and z are two complex numbers such that $|z-w| = |z+w|$, show that $|arg(z) - arg(w)| = \frac{\pi}{2}$ or $\frac{3\pi}{2}$.
- 14.** Determine the modulus and argument of each of the complex numbers:
- $3 - 4i$
 - $\frac{2}{1+i}$
 - $\frac{1-i}{1+i}$
- 15.** If $z = 1 + i$ find $Arg(z)$. hence, find $Arg\left(\frac{1}{z^4}\right)$.
- 16.** Determine the modulus and argument of each of the complex numbers:
- $\cos\theta + i\sin\theta$
 - $\sin\theta + i\cos\theta$
 - $\cos\theta - i\sin\theta$
- 17.** Find the modulus and argument of
- $1 + i\tan\alpha$
 - $\tan\alpha - i$
 - $1 + \cos\theta + i\sin\theta$

18. (a) i. Express $\frac{1 + \sqrt{3}i}{\sqrt{3} + i}$ in the form $u + vi$.
 ii. Let α be the angle as shown in the diagram. Use part i. to find α , clearly explaining your reason(s).

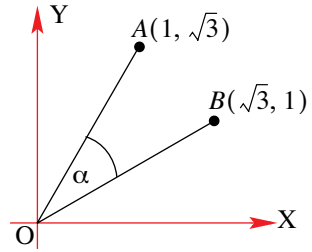

- (b) Hence, find $Arg(z)$ where $z = \left(\frac{1 + \sqrt{3}i}{\sqrt{3} + i}\right)^7$.

19. (a) Find i. the modulus
 ii. the principal argument
 of the complex number $1 - \cos\theta - i\sin\theta$.
 (b) On an Argand diagram, for the case $0 < \theta < \pi$, interpret geometrically the relationship $1 - \cos\theta - i\sin\theta = 2\sin\left(\frac{\theta}{2}\right)\left(\cos\left(\frac{\theta - \pi}{2}\right) + i\sin\left(\frac{\theta - \pi}{2}\right)\right)$.

20. If $z = \cos\theta + i\sin\theta$, prove that i. $\frac{2}{1+z} = 1 - i\tan\left(\frac{\theta}{2}\right)$.
 ii. $\frac{1+z}{1-z} = i\cot\left(\frac{\theta}{2}\right)$.

11.3 POLAR FORM OF COMPLEX NUMBERS

So far we have been dealing with complex numbers of the form $z = x + iy$, where x and y are real numbers. Such a representation of a complex number is known as a **rectangular** representation.

However, the position of a complex number on an Argand diagram has also been described by its magnitude (i.e., its modulus) and the angle which it makes with the positive $Re(z)$ -axis. When we represent a complex number by making use of its modulus and argument, we say that the complex number is in **polar form**.

To **convert from the rectangular form to the polar form**, we make the following observations:

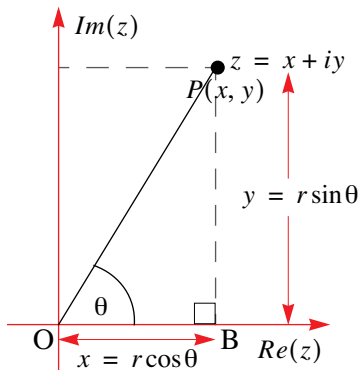

From triangle OBP, we have that

1. $\sin(\theta) = \frac{BP}{OP} = \frac{y}{r} \Rightarrow y = r \sin(\theta)$
2. $\cos(\theta) = \frac{OB}{OP} = \frac{x}{r} \Rightarrow x = r \cos(\theta)$

Therefore, we can rewrite the complex number z as follows:

$$\begin{aligned} z = x + iy &= r \cos(\theta) + ir \sin(\theta) \\ &= r(\cos\theta + i\sin\theta) \end{aligned}$$

When $z = x + iy$ is expressed in the form $z = r(\cos \theta + i \sin \theta)$, we say that **z is in polar form.**

Often, we abbreviate the expression $z = r(\cos \theta + i \sin \theta)$ to

$$z = \underbrace{r}_{r} (\underbrace{c}_{c} \cos \theta + \underbrace{i}_{i} \underbrace{s}_{s} \underbrace{\sin \theta}_{\theta}) = \mathbf{rcis}(\theta)$$

When converting from rectangular to polar form, the angle θ refers to the Principal argument.

EXAMPLE 11.20

Express the following complex numbers in polar form

- (a) $z = \sqrt{3} + i$ (b) $z = -1 - i$

S
O
L
U
T
I
O
N

It is advisable to draw a diagram when converting from rectangular to polar form:

(a)

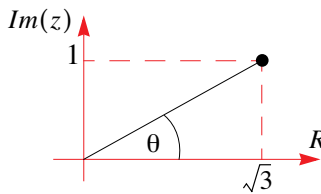

Step 1 Find θ : $\tan(\theta) = \frac{1}{\sqrt{3}} \therefore \theta = \frac{\pi}{6}$

Step 2 Find r : $r = \sqrt{1^2 + (\sqrt{3})^2} = 2$

Therefore, $z = \sqrt{3} + i = 2\left(\cos \frac{\pi}{6} + i \sin \frac{\pi}{6}\right) = 2cis\left(\frac{\pi}{6}\right)$

(b)

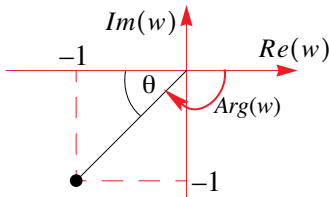

Step 1 Find θ : $\tan(\theta) = \frac{1}{1} \therefore \theta = \frac{\pi}{4}$

Therefore, $Arg(w) = -\frac{3\pi}{4}$.

Step 2 Find r : $r = \sqrt{1^2 + (1)^2} = \sqrt{2}$

Therefore, $z = -1 - i = \sqrt{2}\left(\cos\left(-\frac{3\pi}{4}\right) + i \sin\left(-\frac{3\pi}{4}\right)\right) = \sqrt{2}cis\left(-\frac{3\pi}{4}\right)$

EXAMPLE 11.21

Express the following complex numbers in polar form;

- (a) $z = 2i$ (b) $z = -4$

S
O
L
U
T
I
O
N

(a)

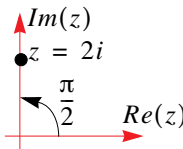

We have that $r = |2i| = 2$. Also, from the diagram, we see that $\theta = \frac{\pi}{2}$.

Therefore, $z = 2i = 2cis\left(\frac{\pi}{2}\right)$.

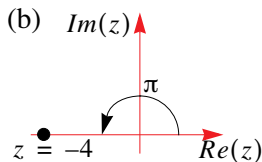

This time, we have that $r = |-4| = 4$. Also, from the diagram, we see that $\theta = \pi$.
Therefore, $z = -4 = 4cis(\pi)$.

EXAMPLE 11.22

Convert $\sqrt{2}cis\left(\frac{3\pi}{4}\right)$ into cartesian form.

S
o
l
u
t
i
o
n

Let $z = \sqrt{2}cis\left(\frac{3\pi}{4}\right)$. Therefore, we have $z = \sqrt{2}\left(\cos\left(\frac{3\pi}{4}\right) + i\sin\left(\frac{3\pi}{4}\right)\right)$ [*'expanding' cis-term*]

$$= \sqrt{2}\left(-\frac{1}{\sqrt{2}} + \frac{1}{\sqrt{2}}i\right)$$

$$= -1 + i$$

Properties of cisθ

We summarise three properties of the $cis(\theta)$ function:

1. $|cis(\theta)| = 1$

Proof:

$$|cis(\theta)| = |\cos(\theta) + i\sin(\theta)| = \sqrt{(\cos\theta)^2 + (\sin\theta)^2} = \sqrt{1} = 1$$

2. $cis(\theta) \times cis(\phi) = cis(\theta + \phi)$

Proof:

$$\begin{aligned} cis(\theta) \times cis(\phi) &= (\cos(\theta) + i\sin(\theta)) \times (\cos(\phi) + i\sin(\phi)) \\ &= (\cos\theta\cos\phi - \sin\theta\sin\phi) + i(\sin\theta\cos\phi + \sin\phi\cos\theta) \\ &= \cos(\theta + \phi) + i\sin(\theta + \phi) \\ &= cis(\theta + \phi) \end{aligned}$$

3. $\frac{cis(\theta)}{cis(\phi)} = cis(\theta - \phi)$

Proof:

$$\frac{cis(\theta)}{cis(\phi)} = \frac{cis(\theta)}{cis(\phi)} \times \frac{cis(-\phi)}{cis(-\phi)} = \frac{cis(\theta - \phi)}{cis(\phi - \phi)} = \frac{cis(\theta - \phi)}{cis(0)} = cis(\theta - \phi)$$

Notice that if we let $z_1 = r_1cis(\theta)$ and $z_2 = r_2cis(\phi)$, the last two results become:

A. $z_1 \times z_2 = r_1r_2cis(\theta + \phi)$

B. $\frac{z_1}{z_2} = \frac{r_1}{r_2}cis(\theta - \phi)$

That is, $\arg(z_1 \times z_2) = \theta + \phi = \arg(z_1) + \arg(z_2)$, and $\arg\left(\frac{z_1}{z_2}\right) = \theta - \phi = \arg(z_1) - \arg(z_2)$.

As well as, $|z_1 \times z_2| = r_1 \times r_2 = |z_1| \times |z_2|$ and $\left|\frac{z_1}{z_2}\right| = \frac{r_1}{r_2} = \frac{|z_1|}{|z_2|}$.

Which correspond to our earlier observations.

EXAMPLE 11.23

Given that $z_1 = 2cis\left(\frac{\pi}{3}\right)$ and $z_2 = 3cis\left(\frac{3\pi}{4}\right)$

- (a) Find $z_1 z_2$ in: i. Polar form ii. Cartesian form
- (b) Find $\frac{z_1}{z_2}$ in: i. Polar form ii. Cartesian form
- (c) Determine the value of i. $\arg(z_1 z_2)$ ii. $Arg(z_1 z_2)$

Solution

(a) i. $z_1 z_2 = 2cis\left(\frac{\pi}{3}\right) \times 3cis\left(\frac{3\pi}{4}\right) = 2 \times 3cis\left(\frac{\pi}{3} + \frac{3\pi}{4}\right) = 6cis\left(\frac{13\pi}{12}\right)$

ii. $6cis\left(\frac{13\pi}{12}\right) = 6\left(\cos\frac{13\pi}{12} + i\sin\frac{13\pi}{12}\right)$
 $= -5.7956 - 1.5529i$

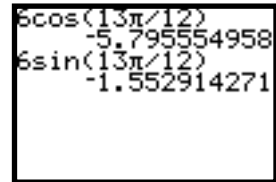

(b) i. $\frac{z_1}{z_2} = \frac{2cis\left(\frac{\pi}{3}\right)}{3cis\left(\frac{3\pi}{4}\right)} = \frac{2}{3}cis\left(\frac{\pi}{3} - \frac{3\pi}{4}\right) = \frac{2}{3}cis\left(-\frac{5\pi}{12}\right)$

ii. $\frac{2}{3}cis\left(-\frac{5\pi}{12}\right) = \frac{2}{3}\left(\cos\left(-\frac{5\pi}{12}\right) + i\sin\left(-\frac{5\pi}{12}\right)\right)$
 $= 0.1725 - 0.6440i$

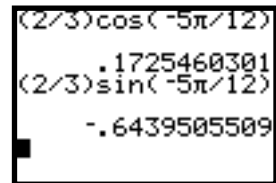

(c) i. $\arg(z_1 z_2) = \arg(z_1) + \arg(z_2) = \frac{\pi}{3} + \frac{3\pi}{4} = \frac{13\pi}{12}$

ii. To determine the principal argument, first sketch a diagram: So, although

$\arg(z_1 z_2) = \frac{13\pi}{12}$, we have that $Arg(z_1 z_2) = -\frac{11\pi}{12}$.

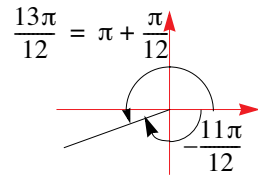

EXAMPLE 11.24

Express $1 + \cos\theta - i\sin\theta$ in polar form where $-\pi/2 < \theta < 0$.

Solution

We start by letting $z = (1 + \cos\theta) - i\sin\theta = \left[1 + 2\cos^2\left(\frac{\theta}{2}\right) - 1\right] - i\left[2\sin\left(\frac{\theta}{2}\right)\cos\left(\frac{\theta}{2}\right)\right]$
 $= 2\cos^2\left(\frac{\theta}{2}\right) - 2\sin\left(\frac{\theta}{2}\right)\cos\left(\frac{\theta}{2}\right)i$

We next rearrange the expression into the required form, $rcis(\alpha) = r[\cos\alpha + isina]$.

MATHEMATICS – Higher Level (Core)

$$\begin{aligned}\text{Now, } 2\cos^2\left(\frac{\theta}{2}\right) - 2\sin\left(\frac{\theta}{2}\right)\cos\left(\frac{\theta}{2}\right)i &= 2\cos\left(\frac{\theta}{2}\right)\left[\cos\left(\frac{\theta}{2}\right) - i\sin\left(\frac{\theta}{2}\right)\right] \\ &= 2\cos\left(\frac{\theta}{2}\right)\left[\cos\left(-\frac{\theta}{2}\right) + i\sin\left(-\frac{\theta}{2}\right)\right] \\ &= -2\cos\left(\frac{\theta}{2}\right)\left[\cos\left(\pi - \frac{\theta}{2}\right) + i\sin\left(\pi - \frac{\theta}{2}\right)\right]\end{aligned}$$

So we have that $r = -2\cos\left(\frac{\theta}{2}\right)$ and as $-\frac{\pi}{2} < \theta < 0 \Rightarrow \cos\left(\frac{\theta}{2}\right) < 0 \Rightarrow r > 0$ and $\alpha = \left(\pi - \frac{\theta}{2}\right)$.

That is, $1 + \cos\theta - i\sin\theta = -2\cos\left(\frac{\theta}{2}\right)\text{cis}\left[\left(\pi - \frac{\theta}{2}\right)\right]$, $-\frac{\pi}{2} < \theta < 0$.

De Moivre's Theorem

We have already seen that if $z_1 = r_1\text{cis}(\theta)$ and $z_2 = r_2\text{cis}(\phi)$, then $z_1 \times z_2 = r_1r_2\text{cis}(\theta + \phi)$.

Next, if $z_1 = z_2 = z = r\text{cis}(\theta)$ (say), we then have that

$$z^2 = z \times z = r\text{cis}(\theta) \times r\text{cis}(\theta) = r^2\text{cis}(\theta + \theta).$$

That is, $z^2 = r^2\text{cis}(2\theta)$.

Similarly, $z^3 = z \times z^2 = r\text{cis}(\theta) \times r^2\text{cis}(2\theta) = r^3\text{cis}(\theta + 2\theta)$.

That is, $z^3 = r^3\text{cis}(3\theta)$.

In general then, we have that $z^n = r^n\text{cis}(n\theta)$.

De Moivre's Theorem states:

$$(r(\cos\theta + i\sin\theta))^n = r^n(\cos\theta + i\sin\theta)^n = r^n(\cos(n\theta) + i\sin(n\theta))$$

Proof: (By Mathematical Induction)

Let $P(n)$ be the proposition that $(r\text{cis}(\theta))^n = r^n\text{cis}(n\theta)$.

For $n = 1$, we have that L.H.S = $(r\text{cis}(\theta))^1 = r\text{cis}(\theta) = r^1\text{cis}(1 \times \theta) = \text{R.H.S}$

Therefore, $P(n)$ is true for $n = 1$.

Assume now that $P(n)$ is true for $n = k$, that is, $(r\text{cis}(\theta))^k = r^k\text{cis}(k\theta)$.

Then, for $n = k + 1$, we have

$$\begin{aligned}(r\text{cis}(\theta))^{k+1} &= (r\text{cis}(\theta))^k(r\text{cis}(\theta)) \\ &= r^k\text{cis}(k\theta)(r\text{cis}(\theta)) \\ &= r^{k+1}\text{cis}(k\theta)\text{cis}(\theta) \\ &= r^{k+1}\text{cis}(k\theta + \theta) \\ &= r^{k+1}\text{cis}((k + 1)\theta)\end{aligned}$$

Therefore, we have that $P(k + 1)$ is true whenever $P(k)$ is true. Therefore, as $P(1)$ is true, by the Principle of Mathematical Induction, $P(n)$ is true for $n = 1, 2, 3, \dots$

Note that the case $n = 0$ is the trivial case.

Notice that De Moivre's Theorem holds for all integral values of n , both positive and negative, i.e., $n \in \mathbb{Z} \cup \{0\}$ as well as rational values of n , i.e., $n \in \mathbb{Q}$.

Graphical properties of De Moivre's Theorem

For the complex number $z = rcis(\theta)$, we have

$$1. \quad z^{-1} = (rcis(\theta))^{-1} = \frac{1}{r}cis(-\theta)$$

i.e., $|z^{-1}| = |z|^{-1} = \frac{1}{r}$ and $\arg(z^{-1}) = -\theta$.

$$2. \quad z^2 = (rcis(\theta))^2 = r^2cis(2\theta)$$

i.e., $|z^2| = |z|^2 = r^2$ and $\arg(z^2) = 2\theta$.

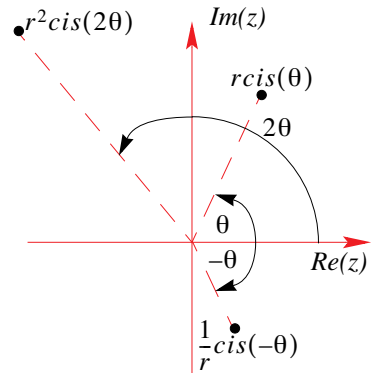

Conjugate powers in polar form

De Moivre's Theorem provides a direct method of establishing the following result:

$$\text{If } z = rcis(\theta) \text{ then } (\bar{z})^n = \overline{(z^n)}$$

EXAMPLE 11.25

Find $(\sqrt{3} + i)^5$ using De Moivre's Theorem

S
o
l
u
t
i
o
n

Let $z = \sqrt{3} + i$.

This means that $r = |\sqrt{3} + i| = \sqrt{(\sqrt{3})^2 + 1^2} = 2$ and

$$\theta = \tan^{-1}\left(\frac{1}{\sqrt{3}}\right) = \frac{\pi}{6}.$$

Therefore, we have that $z = \sqrt{3} + i = 2cis\left(\frac{\pi}{6}\right)$.

Using De Moivre's Theorem, we have

$$\begin{aligned} (\sqrt{3} + i)^5 &= 2^5cis\left(\frac{5\pi}{6}\right) = 32cis\left(\frac{5\pi}{6}\right) \\ &= 32\left(\cos\left(\frac{5\pi}{6}\right) + i\sin\left(\frac{5\pi}{6}\right)\right) \\ &= 32\left(-\frac{\sqrt{3}}{2} + \frac{1}{2}i\right) \\ &= -16\sqrt{3} + 16i \end{aligned}$$

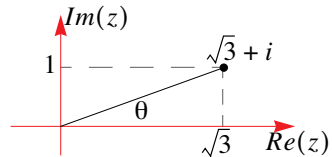

EXAMPLE 11.26

Find $(-1 + i)^{-4}$ using De Moivre's Theorem.

Solution

Let $z = -1 + i$.

This means that $r = |-1 + i| = \sqrt{(-1)^2 + 1^2} = \sqrt{2}$ and

$$\theta = \text{Tan}^{-1}\left(\frac{1}{-1}\right) = \frac{\pi}{4} \therefore \text{Arg}(z) = \frac{3\pi}{4}.$$

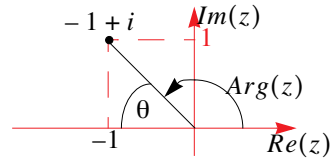

Therefore, we have that $z = -1 + i = \sqrt{2} \text{cis}\left(\frac{3\pi}{4}\right)$.

Using De Moivre's Theorem, we have

$$\begin{aligned} (-1 + i)^{-4} &= (\sqrt{2})^{-4} \text{cis}\left(-4 \times \frac{3\pi}{4}\right) = \frac{1}{(\sqrt{2})^4} \text{cis}(-3\pi) \\ &= \frac{1}{4} (\cos(-3\pi) + i \sin(-3\pi)) \\ &= \frac{1}{4} (-1 + 0i) \\ &= -\frac{1}{4} \end{aligned}$$

EXAMPLE 11.27

Express $\frac{1+i}{(1-i)^3}$ in polar form.

Solution

We first convert both numerator and denominator into polar form.

$$1 + i = \sqrt{2} \text{cis}\left(\frac{\pi}{4}\right) \text{ [standard result] } \& \ 1 - i = \sqrt{2} \text{cis}\left(-\frac{\pi}{4}\right) \therefore (1 - i)^3 = (\sqrt{2})^3 \text{cis}\left(-\frac{3\pi}{4}\right)$$

$$\text{Therefore, } \frac{1+i}{(1-i)^3} = \frac{\sqrt{2} \text{cis}\left(\frac{\pi}{4}\right)}{2\sqrt{2} \text{cis}\left(-\frac{3\pi}{4}\right)} = \frac{1}{2} \text{cis}\left[\left(\frac{\pi}{4}\right) - \left(-\frac{3\pi}{4}\right)\right] = \frac{1}{2} \text{cis}(\pi) = \frac{1}{2} \cos \pi + \frac{1}{2} i \sin \pi.$$

EXAMPLE 11.28

Simplify (a) $(1 + i)^5 + (1 - i)^5$ (b) $(1 + i)^5(1 - i)^5$

Solution

(a) We first convert each term into its polar form:

$$1 + i = \sqrt{2} \text{cis}\left(\frac{\pi}{4}\right) \therefore (1 + i)^5 = (\sqrt{2})^5 \text{cis}\left(5 \times \frac{\pi}{4}\right) = 4\sqrt{2} \text{cis}\left(\frac{5\pi}{4}\right),$$

$$1 - i = \sqrt{2} \text{cis}\left(-\frac{\pi}{4}\right) \therefore (1 - i)^5 = (\sqrt{2})^5 \text{cis}\left(5 \times -\frac{\pi}{4}\right) = 4\sqrt{2} \text{cis}\left(-\frac{5\pi}{4}\right)$$

$$\begin{aligned} \text{Next, } 4\sqrt{2}cis\left(\frac{5\pi}{4}\right) + 4\sqrt{2}cis\left(-\frac{5\pi}{4}\right) &= 4\sqrt{2}\left[\left(\cos\frac{5\pi}{4} + i\sin\frac{5\pi}{4}\right) + \left(\cos-\frac{5\pi}{4} + i\sin-\frac{5\pi}{4}\right)\right] \\ &= 4\sqrt{2}\left[\left(-\frac{1}{\sqrt{2}} + \frac{1}{\sqrt{2}}i\right) + \left(-\frac{1}{\sqrt{2}} - \frac{1}{\sqrt{2}}i\right)\right] \end{aligned}$$

$$\text{And so, } (1+i)^5 + (1-i)^5 = 4\sqrt{2}\left[-\frac{2}{\sqrt{2}}\right] = -8.$$

$$\begin{aligned} \text{(b) Using the previous results we have, } (1+i)^5(1-i)^5 &= 4\sqrt{2}cis\left(\frac{5\pi}{4}\right) \times 4\sqrt{2}cis\left(-\frac{5\pi}{4}\right) \\ &= 32cis\left(\frac{5\pi}{4} - \frac{5\pi}{4}\right) \\ &= 32cis(0) \\ &= 32 \end{aligned}$$

Notice that whenever we add or multiply the complex numbers $rcis(\theta)$ and $rcis(-\theta)$ a purely real complex number will always result. This can be seen as follows:

1. Adding

$$\begin{aligned} rcis(\theta) + rcis(-\theta) &= r[cis(\theta) + cis(-\theta)] \\ &= r[(\cos\theta + i\sin\theta) + (\cos(-\theta) + i\sin(-\theta))] \\ &= r[(\cos\theta + i\sin\theta) + (\cos\theta - i\sin\theta)] \\ &= r[2\cos\theta] \\ &= 2r\cos\theta \end{aligned}$$

2. Multiplying

$$\begin{aligned} rcis(\theta) \times rcis(-\theta) &= r^2[cis(\theta) \times cis(-\theta)] \\ &= r^2[cis(\theta - \theta)] \\ &= r^2cis(0) \\ &= r^2 \end{aligned}$$

EXAMPLE 11.29

If $(1 + cis\theta)(1 + cis2\theta) = a + bi$, prove that $b = a \tan\left(\frac{3\theta}{2}\right)$.

S
o
l
u
t
i
o
n

Now, $1 + cis\theta = 2\cos\left(\frac{\theta}{2}\right)cis\left(\frac{\theta}{2}\right)$ [see example 11.24] Similarly, $1 + cis2\theta = 2\cos\theta cis\theta$.

$$\begin{aligned} \text{Then, } a + bi &= 2\cos\left(\frac{\theta}{2}\right)cis\left(\frac{\theta}{2}\right) \times 2\cos\theta cis\theta = 4\cos\left(\frac{\theta}{2}\right)\cos\theta cis\left(\frac{\theta}{2} + \theta\right) \\ &= 4\cos\left(\frac{\theta}{2}\right)\cos\theta cis\left(\frac{3\theta}{2}\right) \end{aligned}$$

And so, $a = 4\cos\left(\frac{\theta}{2}\right)\cos\theta\cos\left(\frac{3\theta}{2}\right)$ – Eq. 1. and $b = 4\cos\left(\frac{\theta}{2}\right)\cos\theta\sin\left(\frac{3\theta}{2}\right)$ – Eq. 2.

Then, dividing Eq. 2. by Eq. 1. we have:

$$\frac{b}{a} = \frac{4 \cos\left(\frac{\theta}{2}\right) \cos \theta \sin\left(\frac{3\theta}{2}\right)}{4 \cos\left(\frac{\theta}{2}\right) \cos \theta \cos\left(\frac{3\theta}{2}\right)} = \tan\left(\frac{3\theta}{2}\right) \therefore b = a \tan\left(\frac{3\theta}{2}\right)$$

EXERCISES 11.3

1. Express each of the following complex numbers in polar form

(a) $1 + i$ (b) $-1 + i$ (c) $-1 - i$

2. Express each of the following complex numbers in polar form

(a) $2 + 2i$ (b) $\sqrt{3} + i$ (c) $4 - 4i$
 (d) $3 + 4i$ (e) $-2 + i$ (f) $-2 - 3i$
 (g) $-\sqrt{3} + i$ (h) $\frac{1}{2} - \frac{\sqrt{3}}{2}i$ (i) $3 - i$

3. Express each of the following complex numbers in cartesian form

(a) $2 \operatorname{cis}\left(\frac{\pi}{2}\right)$ (b) $3 \operatorname{cis}\left(\frac{\pi}{6}\right)$ (c) $\sqrt{2} \operatorname{cis}\left(-\frac{\pi}{4}\right)$
 (d) $5 \operatorname{cis}\left(\frac{3\pi}{2}\right)$ (e) $-8 \operatorname{cis}\left(-\frac{\pi}{3}\right)$ (f) $\frac{\sqrt{2}}{3} \operatorname{cis}\left(\frac{7\pi}{3}\right)$

4. Simplify the following

(a) $\frac{|2 + i|}{|1 - \sqrt{2}i|}$ (b) $\frac{zz^*}{|z|^2}$ (c) $\operatorname{Arg}(z) + \operatorname{Arg}(z^*)$

5. If $z = \sqrt{2} \operatorname{cis}\left(\frac{\pi}{4}\right)$ and $w = 1 + \sqrt{3}i$, find the following, giving your answer in the form $u + iv$.

(a) w^* (b) z^* (c) wz

6. (a) If $z = x + iy$, show that $z + \frac{|z|^2}{z} = 2 \operatorname{Re}(z)$.
 (b) If $z = x + iy$, show that i. $|z| = |\bar{z}|$ ii. $z\bar{z} = |z|^2$

7. If $z = 1 + i$ and $w = -1 + \sqrt{3}i$, find

(a) $|z|$ (b) $|w|$ (c) $|zw|$
 (d) $\operatorname{Arg}(z)$ (e) $\operatorname{Arg}(w)$ (f) $\operatorname{Arg}(zw)$

8. Express each of the following in the form $x + iy$

(a) $(1 + i)^5$ (b) $(-1 + i)^4$ (c) $(2 + 2i)^3$
 (d) $(-\sqrt{3} + i)^4$ (e) $(\sqrt{3} - i)^5$ (f) $(3 - 4i)^3$

9. Express each of the following in the form $x + iy$

(a) $(1 + i)^{-5}$ (b) $(-1 + i)^{-4}$ (c) $(2 + 2i)^{-3}$
 (d) $(-\sqrt{3} + i)^{-4}$ (e) $(\sqrt{3} - i)^{-5}$ (f) $(3 - 4i)^{-3}$

10. Express each of the following in the form $x + iy$

(a) $\left(2cis\left(\frac{\pi}{2}\right)\right)^3$ (b) $\left(3cis\left(\frac{\pi}{6}\right)\right)^4$ (c) $\left(\sqrt{2}cis\left(-\frac{\pi}{4}\right)\right)^{-2}$
 (d) $\left(5cis\left(\frac{3\pi}{2}\right)\right)^{-3}$ (e) $\left(-8cis\left(-\frac{\pi}{3}\right)\right)^{-1}$ (f) $\left(\frac{\sqrt{2}}{3}cis\left(\frac{7\pi}{3}\right)\right)^4$

11. Find each of the following, expressing your answer in the form $x + iy$.

(a) $(1 + i)^3(2 - 2i)^4$ (b) $(\sqrt{3} + i)^2(1 - i)^2$ (c) $\frac{(2 + 2\sqrt{3}i)^3}{(i - 1)^2}$
 (d) $(\sqrt{3} + i)^4(1 + \sqrt{3}i)^4$ (e) $\frac{(3 + 4i)^4}{(3 - 4i)^2}$ (f) $\frac{(1 + i)^4}{(1 - i)^2}$

12. (a) Prove that $cis(\theta + 2k\pi) = cis(\theta)$, for all integer values of k .
 (b) Using part a., evaluate the following

i. $cis(37\pi)$ ii. $cis(-43\pi)$ iii. $cis\left(\frac{29}{2}\pi\right)$.

13. Simplify the following

a. $cis(\pi)cis\left(-\frac{3\pi}{2}\right)$ b. $2cis\left(\frac{\pi}{12}\right) \times 6cis\left(\frac{\pi}{6}\right)$ c. $\frac{\sqrt{8}cis\left(\frac{\pi}{8}\right)}{\sqrt{2}cis\left(-\frac{\pi}{2}\right)}$

14. (a) Express $cis\left(\frac{\pi}{4}\right)$ and $cis\left(\frac{\pi}{3}\right)$ in the form $x + iy$. Hence, express $cis\left(\frac{7\pi}{12}\right)$ in the form $x + iy$.

(b) Use part a., to find the exact value of i. $\sin\left(\frac{7\pi}{12}\right)$ ii. $\cos\left(\frac{7\pi}{12}\right)$

15. Use De Moivre's theorem to prove that if $z = rcis(\theta)$ then $(\bar{z})^n = \overline{(z^n)}$.

16. (a) If $z = cis(\theta)$, show that

i. $z^2 = \cos(2\theta) + i\sin(2\theta)$
 ii. $z^2 = (\cos^2\theta - \sin^2\theta) + i(2\sin\theta\cos\theta)$

MATHEMATICS – Higher Level (Core)

- Hence, show that
- i. $\sin 2\theta = 2 \sin \theta \cos \theta$
 - ii. $\cos 2\theta = \cos^2 \theta - \sin^2 \theta$
 - iii. $\tan 2\theta = \frac{2 \tan \theta}{1 - \tan^2 \theta}$

(b) Using the same approach as that in part a., derive the following identities:

- i. $\sin 3\theta = 3 \sin \theta - 4 \sin^3 \theta$
- ii. $\cos 3\theta = 4 \cos^3 \theta - 3 \cos \theta$
- iii. $\tan 3\theta = \frac{3 \tan \theta - \tan^3 \theta}{1 - 3 \tan^2 \theta}$

17. If $z = cis \theta$, prove that

- i. $z^n + \frac{1}{z^n} = 2 \cos n\theta$
- ii. $z^n - \frac{1}{z^n} = 2i \sin n\theta$

18. If $z = x + iy$, $y \neq 0$, show that $w = \frac{z}{(1 + z^2)}$, $1 + z^2 \neq 0$, is real, only if $|z| = 1$.

19. Simplify the expression $\frac{1 + i \tan \theta}{1 - i \tan \theta}$. Hence, show that $\left(\frac{1 + i \tan \theta}{1 - i \tan \theta}\right)^k = \frac{1 + i \tan k\theta}{1 - i \tan k\theta}$ where k is a positive integer.

20. Consider the complex number $z = cis\left(\frac{2k\pi}{5}\right)$ for any integer k such that $z \neq 1$.

- (a) Show that $z^n + \frac{1}{z^n} = 2 \cos\left(\frac{2nk\pi}{5}\right)$ for any integer n .
- (b) Show that $z^5 = 1$. Hence, or otherwise, show that $1 + z + z^2 + z^3 + z^4 = 0$.
- (c) Find the value of b , given that $\left(z + \frac{1}{z}\right)^2 + \left(z^2 + \frac{1}{z^2}\right)^2 = b$.

21. If n is a positive integer, show that $(1 + i)^n + (1 - i)^n = 2^{\frac{n}{2} + 1} \cdot \cos\left(\frac{n\pi}{4}\right)$.

22. Simplify the expression $\frac{(1 + cis(-\theta))^3}{(1 + cis(\theta))^3}$.

23. If $u = cis \theta$ and $v = cis \alpha$ express $\frac{u}{v} + \frac{v}{u}$ in terms of θ and α .

24. (a) If $cis \alpha = a$ and $cis \beta = b$, prove that $\sin(\alpha - \beta) = \frac{b^2 - a^2}{2ab} i$.

(b) If $(1 + cis \theta)(1 + cis 2\theta) = a + bi$, prove that $a^2 + b^2 = 16 \cos^2 \theta \cos^2\left(\frac{\theta}{2}\right)$.

25. If $|z| = 1$ and $Arg(z) = \theta$, $0 < \theta < \frac{\pi}{2}$ find

- i. $\left|\frac{2}{1 - z^2}\right|$
- ii. $arg\left(\frac{2}{1 - z^2}\right)$

11.4 POLYNOMIALS OVER THE COMPLEX FIELD

11.4.1 QUADRATIC EQUATIONS

We start this section by looking at equations of the form $ax^2 + bx + c = 0$ where the discriminant, $\Delta = b^2 - 4ac < 0$. Such equations will produce complex solutions.

EXAMPLE 11.30

Factorise, over the complex number field, $z^2 + 2z + 2$. Hence, solve the equation $z^2 + 2z + 2 = 0$ over the complex field.

S
o
l
u
t
i
o
n

We start the same way we would when dealing with any quadratic expression:

$$\begin{aligned} z^2 + 2z + 2 &= (z^2 + 2z + 1) + 1 \quad \text{[complete the square]} \\ &= (z + 1)^2 + 1 \\ &= (z + 1)^2 - i^2 \quad \text{[difference of two squares]} \\ &= (z + 1 + i)(z + 1 - i) \end{aligned}$$

To solve $z^2 + 2z + 2 = 0$, we have, $(z + 1 + i)(z + 1 - i) = 0 \Leftrightarrow z = -1 - i$ or $z = -1 + i$.

Therefore, the two complex solutions are $z = -1 - i$, $z = -1 + i$.

Notice that the solutions are conjugate pairs.

EXAMPLE 11.31

Solve the equation $z^2 + 3z + 5 = 0$ over the complex field.

S
o
l
u
t
i
o
n

Rather than factorising the equation, we will use the quadratic formula.

$$\begin{aligned} z^2 + 3z + 5 = 0 \Leftrightarrow z &= \frac{-3 \pm \sqrt{3^2 - 4 \times 1 \times 5}}{2 \times 1} \\ &= \frac{-3 \pm \sqrt{-11}}{2} \\ &= \frac{-3 \pm \sqrt{11}i}{2} \end{aligned}$$

Therefore, the two complex solutions are $z = -\frac{3}{2} + \frac{\sqrt{11}}{2}i$, $z = -\frac{3}{2} - \frac{\sqrt{11}}{2}i$.

Again, notice the conjugate pair that make up the solution.

Quadratics also come in a ‘hidden form’. For example, the equation $z^6 + 4z^3 - 5 = 0$ can be considered to be a ‘hidden form’. i.e., letting $w = z^3$ we have $w^2 + 4w - 5 = 0$. And so we can then solve the quadratic in w . We could then obtain solutions for z .

EXAMPLE 11.32

Solve the equation $z^4 + 4z^2 - 5 = 0$ over the complex field.

**S
o
l
u
t
i
o
n**

We start by letting $w = z^2$ so that the equation $z^4 + 4z^2 - 5 = 0$ is transformed into the quadratic $w^2 + 4w - 5 = 0$.

$$\text{Then, we have } w^2 + 4w - 5 = 0 \Leftrightarrow (w + 5)(w - 1) = 0$$

$$\Leftrightarrow (z^2 + 5)(z^2 - 1) = 0$$

$$\Leftrightarrow (z - \sqrt{5}i)(z + \sqrt{5}i)(z - 1)(z + 1) = 0$$

Therefore, we have that $z = \sqrt{5}i$ or $z = -\sqrt{5}i$ or $z = 1$ or $z = -1$.

That is, we have four solutions, two real and two complex (again, the complex solutions are conjugate pairs).

EXERCISES 11.4.1

- Factorise the following over the complex number field.

(a) $x^2 - 6x + 10$	(b) $x^2 + 4x + 13$	(c) $x^2 - 2x + 2$
(d) $z^2 + 4z + 5$	(e) $z^2 - 3z + 4$	(f) $z^2 + 10z + 30$
(g) $4w^2 + 4w + 17$	(h) $3w^2 - 6w + 6$	(i) $-2w^2 + 8w - 11$
- Solve the following over the complex number field

(a) $z^2 + 4z + 8 = 0$	(b) $z^2 - z + 3 = 0$	(c) $3z^2 - 3z + 1 = 0$
(d) $2w^2 + 5w + 4 = 0$	(e) $w^2 + 10w + 29 = 0$	(f) $w^2 + 16 = 0$
(g) $w^2 + 12w + 40 = 0$	(h) $3z^2 + 18z + 30 = 0$	(i) $9z^2 + 25 = 0$
- Solve the following over the complex number field

(a) $z^4 - 3z^2 - 4 = 0$	(b) $w^4 - 8w^2 - 9 = 0$	(c) $z^4 - 5z^2 - 36 = 0$
--------------------------	--------------------------	---------------------------
- Factorise the following over the complex number field:

(a) $z^2 + 25$	(b) $z^2 + 49$	(c) $z^2 + 4z + 5$
(d) $z^2 + 6z + 11$	(e) $z^4 + 2z^2 - 8$	(f) $z^4 - z^2 - 6$

11.4.2 POLYNOMIAL EQUATIONS (OF ORDER ≥ 3)

We now look at some of the more general polynomial equations that provide a combination of real and imaginary roots and factors. The important thing to remember is that the laws for real polynomials hold equally well for complex polynomials.

A polynomial, $P(z)$ of degree n in one variable is an expression of the form

$$a_n z^n + a_{n-1} z^{n-1} + \dots + a_1 z + a_0$$

If the coefficients, $a_n, a_{n-1}, \dots, a_1, a_0$ are real, the polynomial is a **polynomial over the real number field**, while if they are complex numbers, the polynomial is a **polynomial over the**

complex field. We shall, however, concentrate on polynomials over the real field.

We state some standard results:

Remainder Theorem

If a polynomial $P(x)$ is divided by a linear polynomial $(x - a)$, the remainder is $P(a)$.

Factor Theorem

If, when a polynomial $P(x)$ is divided by a linear polynomial $(x - a)$, the remainder $P(a)$ is zero, then $(x - a)$ is a factor of $P(x)$.

Fundamental Theorem of Algebra

Every polynomial equation of the form $P(z) = 0$, $z \in C$, of degree $n \in \mathbb{Q}^+$ has at least one complex root.

This theorem is the basis for the next important result:

A polynomial $P_n(z)$, $z \in C$, of degree $n \in \mathbb{Q}^+$, can be expressed as the product of n linear factors and hence, produce exactly n solutions to the equation $P_n(z) = 0$.

We have already observed, in Examples 11.30, 11.31 and 11.32 the occurrence of conjugate pairs when solving quadratics with real coefficients. We now state another result.

Conjugate Root Theorem (C.R.T)

The complex roots of a polynomial equation with **real coefficients** occur in conjugate pairs.

EXAMPLE 11.33

Factorise the polynomial $z^3 - 3z^2 + 4z - 12$, hence solve

$$z^3 - 3z^2 + 4z - 12 = 0.$$

S
o
l
u
t
i
n

Grouping like terms, we have: $z^3 - 3z^2 + 4z - 12 = z^2(z - 3) + 4(z - 3) = (z^2 + 4)(z - 3)$

$$\text{i.e., } z^3 - 3z^2 + 4z - 12 = (z - 2i)(z + 2i)(z - 3)$$

And so, $z^3 - 3z^2 + 4z - 12 = 0 \Leftrightarrow (z - 2i)(z + 2i)(z - 3) = 0$

Therefore, we have that $z = 2i$ or $z = -2i$ or $z = 3$

We observe that two of the roots are conjugate pairs, and when we look at the polynomial, we see that all of the coefficients are real (as expected from the C.R.T).

EXAMPLE 11.34

Given that $z = 1 - i$ is a root of the equation $2z^3 - 7z^2 + 10z - 6 = 0$, find the other roots.

Solution

As all of the coefficients of the polynomial are real, it means that the C.R.T applies. That is, given that $z = 1 - i$ is a root, so too then, is $z = 1 + i$.

Therefore, we have two factors, namely, $z - 1 + i$ and $z - 1 - i$.

This means that $(z - 1 + i)(z - 1 - i) = z^2 - 2z + 2$ is also a factor.

As in the last example, we can factorise by inspection:

$$2z^3 - 7z^2 + 10z - 6 = (az + b)(z^2 - 2z + 2)$$

That is, knowing that we are looking for a cubic, and given that we already have a quadratic factor, then we are left with a linear factor, which we have as $(az + b)$. Then, comparing the coefficients of the z^3 term and the constant term we must have that

$$a = 2 \text{ and } 2b = -6 \Leftrightarrow b = -3.$$

That is, $2z^3 - 7z^2 + 10z - 6 = (2z - 3)(z^2 - 2z + 2)$

Therefore, the roots are $1 - i, 1 + i, \frac{3}{2}$.

EXAMPLE 11.35

If $z - 1 + i$ is a factor of $P(z) = z^3 + 2z^2 - 6z + k$, find the value of k .

Solution

Given that $z - 1 + i$ is a factor of $P(z) = z^3 + 2z^2 - 6z + k$, then, by the factor theorem we must have that $P(1 - i) = 0$.

$$\begin{aligned} \text{So, } (1 - i)^3 + 2(1 - i)^2 - 6(1 - i) + k &= 0 \Leftrightarrow -8 + k = 0 \\ &\Leftrightarrow k = 8 \end{aligned}$$

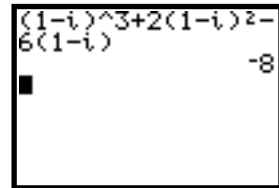

The TI-83 is useful in situations that involve simple evaluation of complex numbers.

EXAMPLE 11.36

Solve the equation $z^3 - 4z^2 + 9z - 10 = 0$, where z is a complex number.

Solution

Let $P(z) = z^3 - 4z^2 + 9z - 10$. Using trial and error (or at least factors of 10), we have:

$$P(1) = 1 - 4 + 9 - 10 = -4 \therefore (z - 1) \text{ is not a factor.}$$

$$P(2) = 8 - 16 + 18 - 10 = 0 \Rightarrow (z - 2) \text{ is a factor.}$$

Therefore, $P(z) = (z - 2)(az^2 + bz + c)$.

Comparing coefficients of the leading term and constant term we have:

$$a = 1 \text{ and } -2c = -10 \Leftrightarrow c = 5$$

Therefore, $P(z) = (z - 2)(z^2 + bz + 5)$.

then, comparing the coefficient of the z^2 term, we have that $b - 2 = -4 \therefore b = -2$.

$$\begin{aligned} \text{So, } P(z) &= (z-2)(z^2-2z+5) = (z-2)[(z^2-2z+1)+4] \quad \text{[completing the square]} \\ &= (z-2)[(z-1)^2+4] \\ &= (z-2)(z-1+2i)(z-1-2i) \end{aligned}$$

$$\text{Therefore, } P(z) = 0 \Leftrightarrow (z-2)(z-1+2i)(z-1-2i) = 0$$

And so, $z = 2$ or $z = 1 - 2i$ or $z = 1 + 2i$.

Realise that we could have used long or synthetic division to factorise $P(z)$ to the stage

$$P(z) = (z-1)(z^2-3z+10). \text{ Both methods are equally valid.}$$

Also, rather than using trial and error you could use your graphics calculator to help find a first real factor.

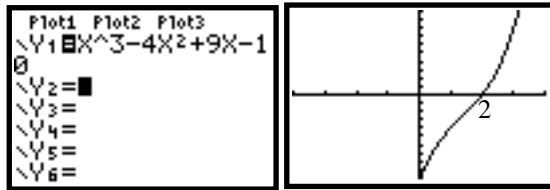

EXAMPLE 11.37

Solve the equation $z^4 + 4z^3 - z - 4 = 0$ where z is a complex number.

S
o
l
u
t
i
o
n

We first factorise the quartic using the method of grouping

$$\begin{aligned} z^4 + 4z^3 - z - 4 &= z^3(z+4) - (z+4) \\ &= (z^3-1)(z+4) \end{aligned}$$

Note: Be careful not to proceed as follows: $(z^3-1)(z+4) = 0 \therefore z = 1, -4$. Solving in this manner is incorrect because z is a complex number and so there must be 4 solutions.

$$\begin{aligned} \text{Now, } (z^3-1)(z+4) &= (z-1)(z^2+z+1)(z+4) \quad \text{[difference of two cubes]} \\ &= (z-1)\left[\left(z^2+z+\frac{1}{4}\right)+1-\frac{1}{4}\right](z+4) \quad \text{[completing the square]} \\ &= (z-1)\left[\left(z+\frac{1}{2}\right)^2+\frac{3}{4}\right](z+4) \\ &= (z-1)\left(z+\frac{1}{2}+\frac{\sqrt{3}}{2}i\right)\left(z+\frac{1}{2}-\frac{\sqrt{3}}{2}i\right)(z+4) \quad \text{[difference of two squares]} \end{aligned}$$

$$\text{Therefore, } z^4 + 4z^3 - z - 4 = 0 \Leftrightarrow (z-1)\left(z+\frac{1}{2}+\frac{\sqrt{3}}{2}i\right)\left(z+\frac{1}{2}-\frac{\sqrt{3}}{2}i\right)(z+4) = 0$$

$$\Leftrightarrow z = 1 \text{ or } z = -\frac{1}{2}-\frac{\sqrt{3}}{2}i \text{ or } z = -\frac{1}{2}+\frac{\sqrt{3}}{2}i \text{ or } z = -4.$$

EXERCISES 11.4.2

1. Factorise the following over the complex number field

(a) $z^3 + 2z^2 + z + 2$

(b) $z^3 - 9z^2 + z - 9$

(c) $z^3 - 2z^2 + 2z - 4$

MATHEMATICS – Higher Level (Core)

- 2.** Factorise the following over the complex number field
- (a) $w^3 + 2w - 12$ (b) $z^3 - 5z^2 + 9z - 5$ (c) $z^3 + z^2 - 2$
(d) $x^4 - 3x^2 - 4$ (e) $w^3 - 2w + 4$ (f) $z^4 - 625$
- 3.** Solve each of the following over the complex number field
- (a) $z^3 - 7z^2 + 31z - 25 = 0$ (b) $z^3 - 8z^2 + 25z - 26 = 0$
(c) $z^4 - 3z^3 - 2z^2 + 10z - 12 = 0$ (d) $2w^3 + 3w^2 + 2w - 2 = 0$
(e) $6z^4 - 11z^3 + z^2 + 33z - 45 = 0$ (f) $z^3 + 7z^2 + 16z + 10 = 0$
- 4.** Given that $\frac{1}{2}(-1 + \sqrt{3}i)$ is a root of $3z^3 + 2z^2 + 2z - 1 = 0$, find all three roots.
- 5.** Given that $(z - 1 - 2i)$ is a factor of $2z^3 - 3z^2 + 8z + 5$, solve the equation $2z^3 - 3z^2 + 8z + 5 = 0$ over the complex number field.
- 6.** Given that $P(2 - 3i) = 0$, find all three linear factors of $z^3 - 7z^2 + 25z - 39$
- 7.** Find all complex numbers, z , such that $z^4 - z^3 + 6z^2 - z + 15 = 0$ and $z = 1 + 2i$ is a solution to the equation.
- 8.** Factorise the following
- (a) $2z^3 - z^2 + 2z - 1$ (b) $z^4 + z^2 - 12$
- 9.** Given that $2 - i$ is a root of $z^3 + az^2 + z + 5 = 0$, where a is a real number, find all the roots to this equation.
- 10.** Given that $2 + 3i$ is a root of $z^3 + az^2 + b = 0$, where a and b are real numbers, find all the roots of this equation.
- 11.** Given that $2 - i$ is a root of $2z^3 - 9z^2 + 14z - 5 = 0$, find the other roots.
- 12.** Given that $4 - i$ is a zero of $P(z) = z^3 + az^2 + 33z - 34$, find a and hence factorise $P(z)$.
- 13.** Given that $z - 2$ and $z - 1 - i$ are factors of $P(z) = z^3 - az^2 + 6z + b$, factorise $P(z)$.
- 14.** Solve the following over the real number field.
- (a) $z^6 + 7z^3 - 8 = 0$ (b) $z^6 - 9z^3 + 8 = 0$
(c) $z^4 - 2z^2 - 3 = 0$ (d) $z^4 - 4z^2 - 5 = 0$
- 15.** Write down an equation of the lowest possible degree with real coefficients such that its roots are
- (a) $3, 2 - i$ (b) $2, 1, 1 + i$ (c) $1 - \sqrt{3}i, 3$ (d) $1 + \sqrt{2}i, -2 + \sqrt{3}i$
- 16.** Verify that $z = -1 + \sqrt{3}i$ is a root of the equation $z^4 - 4z^2 - 16z - 16 = 0$ and hence find the other roots.

- 17.** Given that $z = a + ib$ is a root of $z^4 - z^3 - 6z^2 + 11z + 5 = 0$ and $Re(z) = 2$, solve the equation completely.
- 18.** If $z^n + z^{-n} = 2 \cos(n\theta)$ show that $5z^4 - z^3 - 6z^2 - z + 5 = 0 \Rightarrow 10\cos^2\theta - \cos\theta - 8 = 0$.
- 19.** Show that $\cos 5\theta = 16\cos^5\theta - 20\cos^3\theta + 5\cos\theta$, and hence show that the roots of $x(16x^4 - 20x^2 + 5) = 0$ are $0, \cos\left(\frac{\pi}{10}\right), \cos\left(\frac{3\pi}{10}\right), \cos\left(\frac{7\pi}{10}\right), \cos\left(\frac{9\pi}{10}\right)$.

11.4.3 SOLUTION TO EQUATIONS OF THE FORM $z^n = x + iy$

Definition The n th root of the complex number $x + iy$ are the solutions of the equation $z^n = x + iy$.

We summarise the approaches available to solve equations of the general form $z^n = x + iy$.

Solving equations of the form $z^n = x + iy$.

1. a factorisation technique or use
2. De Moivre's theorem, together with the result that the n distinct n th roots of $r(\cos\theta + i\sin\theta)$ are given by

$$r^{\frac{1}{n}} \left(\cos\left(\frac{\theta + 2k\pi}{n}\right) + i \sin\left(\frac{\theta + 2k\pi}{n}\right) \right), k = 0, 1, 2, \dots, n-1$$

That is,

$$z^n = x + iy \Rightarrow z = r^{\frac{1}{n}} \left(\cos\left(\frac{\theta + 2k\pi}{n}\right) + i \sin\left(\frac{\theta + 2k\pi}{n}\right) \right), k = 0, 1, 2, \dots, n-1$$

Geometrically, we have that the n th roots of a complex number are represented in an Argand diagram as the vertices of a regular polygon of n sides, inscribed in a circle of radius $\sqrt[n]{r}$, and spaced at intervals of $\frac{2\pi}{n}$ from each other.

The steps involved in solving equations of the form $z^n = x + iy$ (even for the case that $y = 0$) are:

- Step 1.** Express $x + iy$ in polar form, $r \operatorname{cis}(\theta)$
- Step 2.** Realise that $r \operatorname{cis}(\theta) = r \operatorname{cis}(\theta + 2k\pi)$, where k is an integer, because everytime that you add another 2π , you return to the same position.
- Step 3.** Use De Moivre's theorem:

$$z^n = r \operatorname{cis}(\theta + 2k\pi) \therefore z = [r \operatorname{cis}(\theta + 2k\pi)]^{\frac{1}{n}} = r^{\frac{1}{n}} \operatorname{cis}\left(\frac{\theta + 2k\pi}{n}\right)$$

Step 4. Use n values of k , usually start at $k = 0, 1, \dots$ and end at $k = n-1$. This will produce the n required solutions

$$z = r^{\frac{1}{n}} \operatorname{cis}\left(\frac{\theta}{n}\right), r^{\frac{1}{n}} \operatorname{cis}\left(\frac{\theta + 2\pi}{n}\right), r^{\frac{1}{n}} \operatorname{cis}\left(\frac{\theta + 4\pi}{n}\right), \dots, r^{\frac{1}{n}} \operatorname{cis}\left(\frac{\theta + 2(n-1)\pi}{n}\right)$$

We consider two cases. The first will be when z^n is equal to a real number, i.e., $z^n = x$ and the second case will be when z^n is equal to a complex number.

Case 1. z^n is equal to a real number

Solving these equations can sometimes be done directly. For example, $z^4 = 81$ can be solved by first rewriting the equation as $z^4 - 81 = 0$ and then factorising $z^4 - 81$ as follows

$$z^4 - 81 = (z^2 - 9)(z^2 + 9) = (z - 3)(z + 3)(z - 3i)(z + 3i)$$

which then produces the solution set $\{\pm 3, \pm 3i\}$. On the otherhand, the equation $z^4 = -81$ might require considerably more work.

Solving $z^4 - 81 = 0$ can also be viewed as finding the 4th root of 81, i.e., $z = 81^{1/4}$. Again, realise that the 4th root of 81 produces 4 possible answers. In both instances we can use one of two methods to solve the equation. Either make use of a factorisation process or make use of De Moivre's theorem.

EXAMPLE 11.38

Find the 4th roots of 16 by using (a) factorisation,
(b) the 'nth root method'

S
o
l
u
t
i
o
n

(a) The fourth roots of 16 are given by the solutions to the equation $z^4 = 16$.

$$\text{This means that } z^4 = 16 \Leftrightarrow z^4 - 16 = 0$$

$$\Leftrightarrow (z^2)^2 - 4^2 = 0$$

$$\Leftrightarrow (z^2 - 4)(z^2 + 4) = 0$$

$$\Leftrightarrow (z - 2)(z + 2)(z^2 - (2i)^2) = 0$$

$$\Leftrightarrow (z - 2)(z + 2)(z - 2i)(z + 2i) = 0$$

$$\Leftrightarrow z = 2 \text{ or } -2 \text{ or } 2i \text{ or } -2i$$

Notice that we had to make use of the fact that $-(2i)^2 = 4$ to factorise the term $z^2 + 4$. By using this 'trick' we were able to convert a sum of two squares to a difference of two squares (and so enabling us to factorise).

(b) Next we make use of the n th root approach. For this problem, we have that $n = 4$, meaning that $k = 0, 1, 2, 3$.

Step 1. $16 = 16\operatorname{cis}(0)$ [expressing 16 in polar form].

Step 2. $z^4 = 16\operatorname{cis}(0) = 16\operatorname{cis}(0 + 2k\pi), k = 0, 1, 2, 3$.

Step 3. $\therefore z = 16^{\frac{1}{4}} \operatorname{cis}\left(\frac{0 + 2k\pi}{4}\right), k = 0, 1, 2, 3$

$$\therefore z = 2cis\left(\frac{2k\pi}{4}\right), k = 0, 1, 2, 3$$

Step 4. $z = 2cis(0), 2cis\left(\frac{\pi}{2}\right), 2cis(\pi), 2cis\left(\frac{3\pi}{2}\right)$ [Using $k = 0, 1, 2, 3$]

$$\therefore z = 2, 2i, -2, -2i$$

In this case there was not a lot a difference between the two methods, in that the factorisation was fairly straight forward.

Geometrically, the solutions can be found on the Argand diagram and are equidistant from the origin and are equally spaced at 90° on a circle of radius 2 units.

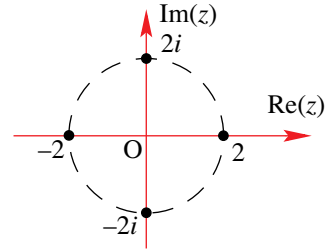

nth roots of unity

Given $z^n = 1$, we rewrite it as $z^n = 1(\cos 0 + i \sin 0)$

$$= 1(\cos(0 + 2k\pi) + i \sin(0 + 2k\pi))$$

$$\Rightarrow z = 1^{\frac{1}{n}} \left(\cos\left(\frac{0 + 2k\pi}{n}\right) + i \sin\left(\frac{0 + 2k\pi}{n}\right) \right)$$

$$\Leftrightarrow z = \left(\cos\left(\frac{2k\pi}{n}\right) + i \sin\left(\frac{2k\pi}{n}\right) \right), \text{ where } k = 0, 1, 2, \dots, (n-1)$$

Thus, the n th roots of unity are equally spaced around the unit circle with centre at the origin and forming the vertices of a regular n sided polygon.

Note then that for the case where z^n is equal to a real number we express z^n as $x + 0i$.

This will mean that $z^n = x[\cos 0 + i \sin 0] \Rightarrow z^n = x[\cos(0 + 2k\pi) + i \sin(0 + 2k\pi)]$

$$\therefore z^n = xcis(2k\pi)$$

$$\therefore z = x^{\frac{1}{n}} cis\left(\frac{2k\pi}{n}\right), k = 0, 1, 2, \dots, n-1$$

EXAMPLE 11.39

Find the 6th roots of 64, leaving your answer in polar form.

S
o
l
u
t
i
o
n

Setting $z^6 = 64$ we have, $z^6 = 64 + 0i = 64[cis(0) + i \sin(0)]$

$$= 64cis(0)$$

$$= 64cis(0 + 2k\pi)$$

$$\therefore z = 64^{1/6} cis\left(\frac{2k\pi}{6}\right), k = 0, 1, 2, 3, 4, 5$$

Therefore, we have $z = 2cis\left(\frac{\pi k}{3}\right), k = 0, 1, 2, 3, 4, 5$.

So that, $z = 2cis(0), 2cis\left(\frac{\pi}{3}\right), 2cis\left(\frac{2\pi}{3}\right), 2cis(\pi), 2cis\left(\frac{4\pi}{3}\right), 2cis\left(\frac{5\pi}{3}\right)$

Case 2. z^n is equal to a complex number

The process for solving these equations does not change. We proceed with two examples.

EXAMPLE 11.40

Find the cube roots of $8i$.

S
O
L
V
E
I
O
N

This time we need to solve the equation $z^3 = 8i$.

Had the equation been $z^3 = 8$, then factorisation would have been appropriate. However, as it stands, the preferred method this time is the n th root method.

First we convert to polar form, i.e., $z^3 = 8i = 8cis\left(\frac{\pi}{2}\right) = 8cis\left(\frac{\pi}{2} + 2k\pi\right)$.

Therefore, we have that, $z = 8^{\frac{1}{3}}cis\left(\frac{\frac{\pi}{2} + 2k\pi}{3}\right), k = 0, 1, 2$

$$= 2cis\left(\frac{\frac{\pi}{2} + 2k\pi}{3}\right), k = 0, 1, 2$$

$$= 2cis\left(\frac{\pi}{6}\right), 2cis\left(\frac{5\pi}{6}\right), 2cis\left(\frac{9\pi}{6}\right)$$

$$= 2\left(\frac{\sqrt{3}}{2} + \frac{1}{2}i\right), 2\left(-\frac{\sqrt{3}}{2} + \frac{1}{2}i\right), 2(0 - i)$$

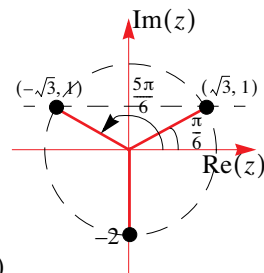

That is, $z = \sqrt{3} + i$ or $z = -\sqrt{3} + i$ or $z = -2i$

The diagram shows the position of the 3 roots. Notice that all three roots lie on a circle of radius 2 units and each root is equally spaced on the circle. Note also that the roots do not occur in conjugate pairs as there is a complex coefficient in $z^3 = 8i$.

EXAMPLE 11.41

Find the four fourth roots of $1 + i\sqrt{3}$. Give your answer in polar form.

S
O
L
V
E
I
O
N

We start by expressing $1 + i\sqrt{3}$ in its polar form: $1 + i\sqrt{3} = 2cis\left(\frac{\pi}{3}\right)$.

Then, set $z^4 = 2cis\left(\frac{\pi}{3}\right) = 2cis\left(\frac{\pi}{3} + 2k\pi\right) = 2cis\left(\frac{\pi + 6k\pi}{3}\right)$

So that, $z = \sqrt[4]{2}cis\left(\frac{\pi + 6k\pi}{12}\right), k = 0, 1, 2, 3$.

For $k = 0$, $z = \sqrt[4]{2}cis\left(\frac{\pi}{12}\right)$; $k = 1$, $z = \sqrt[4]{2}cis\left(\frac{\pi + 6\pi}{12}\right) = \sqrt[4]{2}cis\left(\frac{7\pi}{12}\right)$;

$k = 2$, $z = \sqrt[4]{2}cis\left(\frac{\pi + 12\pi}{12}\right) = \sqrt[4]{2}cis\left(\frac{13\pi}{12}\right)$; $k = 3$, $z = \sqrt[4]{2}cis\left(\frac{\pi + 18\pi}{12}\right) = \sqrt[4]{2}cis\left(\frac{19\pi}{12}\right)$
 $= \sqrt[4]{2}cis\left(-\frac{11\pi}{12}\right) = \sqrt[4]{2}cis\left(-\frac{5\pi}{12}\right)$

Therefore, the four roots of $1 + i\sqrt{3}$ lie on the circumference of a circle of radius $\sqrt[4]{2}$ units and are evenly separated by an angle of $\frac{\pi}{2}$.

Again notice that the roots in this instance do not occur in conjugate pairs.

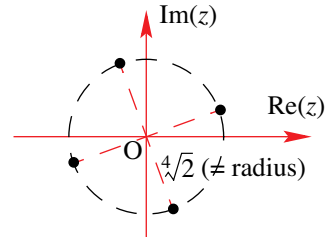

The square root of a complex number

As a special case of the n th roots, of a complex number, we now consider the square root of a complex number. However, this time we will use a different method altogether, bearing in mind that the previous method is still applicable. This approach will be entirely dependent on algebra.

EXAMPLE 11.42

Find the square roots of $3 + 4i$.

S
o
l
u
t
i
n

The only assumption we make here, is that the roots to the equation $z^2 = 3 + 4i$ are complex numbers.

Therefore, we have that $\sqrt{3 + 4i}$ takes on the form $a + ib$ where a and b are real numbers to be determined.

Let $z = a + ib$ be an answer of $z = \sqrt{3 + 4i}$.

Squaring both sides gives $z^2 = (a + ib)^2$ and $z^2 = 3 + 4i$

So that, $3 + 4i = (a + ib)^2$

This gives, $3 + 4i = a^2 - b^2 + 2abi$

$\Leftrightarrow a^2 - b^2 = 3$ and $2ab = 4$ [equating real and imaginary parts]

Solving simultaneously: $b = \frac{2}{a} \Rightarrow a^2 - \left(\frac{2}{a}\right)^2 = 3$

Therefore, we have $\Leftrightarrow a^4 - 3a^2 - 4 = 0$

$\Leftrightarrow (a^2 - 4)(a^2 + 1) = 0$

$\therefore a = \pm 2$ are the only solutions as a is a real number.

Therefore, we have that $a = \pm 2 \Rightarrow b = \pm 1$. i.e., $a = 2, b = 1$ and $a = -2, b = -1$.

Meaning that the square roots are given by $z = 2 + i$ and $z = -2 - i$.

EXERCISES 11.4.3

1. Use the n th root method to solve the following:

(a) $z^3 = 27$ (b) $z^3 = 27i$ (c) $z^3 = -8i$
 (d) $z^4 = -16$ (e) $z^4 = 81i$ (f) $z^6 = -64$

2. Find the fourth roots of -4 in the form $x + iy$ and hence factorise $z^4 + 4$ into linear factors.

3. Find the square roots of

(a) i (b) $3 + 4i$ (c) $-1 + \sqrt{3}i$.

 Represent these roots on an Argand diagram.

4. Find the cube roots of

(a) $1 - i$ (b) $-1 + \sqrt{3}i$ (c) i

 Represent these roots on an Argand diagram.

5. Solve the following equations

(a) $z^4 = 1 + i$ (b) $z^4 = i$ (c) $z^3 + i = 0$
 (d) $z^4 = 8 - 8\sqrt{3}i$ (e) $z^3 = 64i$ (f) $z^2 = \sqrt{3} + i$

 Represent these roots on an Argand diagram.

6. (a) Find the cube root of unity.
 (b) Hence, show that if $w^3 = 1$, then $1 + w + w^2 = 0$.

7. Three points, of which $1 + i\sqrt{3}$ is one point, lie on the circumference of a circle of radius 2 units and centre at the origin. If these three points form the vertices of an equilateral triangle, find the other two points.

8. If $1, w_1$ and w_2 are the cube roots of unity, prove that

(a) $w_1 = \overline{w_2} = w_2^2$ (b) $w_1 + w_2 = -1$ (c) $w_1 w_2 = 1$

9. Given that w is a complex root of the equation $z^5 - 1 = 0$ and is such that it has the smallest positive argument, show that w^2, w^3 and w^4 are the other complex roots.

(a) Hence show that $1 + w + w^2 + w^3 + w^4 = 0$.
 (b) Factorise $z^5 - 1$ into real linear and quadratic factors.

Hence deduce that

 - i. $2\left(\cos\left(\frac{2\pi}{5}\right) + \cos\left(\frac{4\pi}{5}\right)\right) = -1$
 - ii. $4\cos\left(\frac{2\pi}{5}\right)\cos\left(\frac{4\pi}{5}\right) = -1$

10. Show that the roots of $(z - 1)^6 + (z + 1)^6 = 0$ are $\pm i, \pm i \cot\left(\frac{5\pi}{12}\right), \pm i \cot\left(\frac{\pi}{12}\right)$.

11.5 MISCELLANEOUS PROOFS

In this section we produce a number of proofs to some of the theorems that were simply stated and used in this chapter.

11.5.1 THE TRIANGLE INEQUALITY

The triangle inequality states that the length measure of a side of a triangle does not exceed the sum of the length measures of the other two sides.

That is,

$$|z + w| \leq |z| + |w|$$

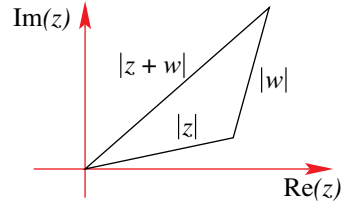

Before we begin the proof we revisit some results:

1. $z\bar{w} + \bar{z}w = 2\operatorname{Re}(z\bar{w})$

Proof: $z\bar{w} + \bar{z}w = z\bar{w} + \bar{z}(\overline{\bar{w}}) = z\bar{w} + (\overline{z\bar{w}}) = 2\operatorname{Re}(z\bar{w})$

2. $2|z||w| - (z\bar{w} + \bar{z}w) \geq 0$

Proof: $|z||w| = |z|\overline{|w|} = |z\bar{w}| \geq \operatorname{Re}(z\bar{w}) \Rightarrow |z\bar{w}| - \operatorname{Re}(z\bar{w}) \geq 0$
 $\therefore 2|z\bar{w}| - 2\operatorname{Re}(z\bar{w}) \geq 0$
 $\Rightarrow 2|z||w| - (z\bar{w} + \bar{z}w) \geq 0$ [from 1.]

Now, $|z + w|^2 = (z + w)\overline{(z + w)} = (z + w)(\bar{z} + \bar{w})$
 $= z\bar{z} + z\bar{w} + w\bar{z} + w\bar{w}$
 $= |z|^2 + |w|^2 + (z\bar{w} + \bar{z}w)$
 $= |z|^2 + |w|^2 + 2|z||w| - [2|z||w| - (z\bar{w} + \bar{z}w)]$
 $= (|z| + |w|)^2 - [2|z||w| - (z\bar{w} + \bar{z}w)]$

Then, as $2|z||w| - (z\bar{w} + \bar{z}w) \geq 0 \leq (|z| + |w|)^2$. [from 2.]

So, as $|z + w| \geq 0$ and $(|z| + |w|) \geq 0$, we have that $|z + w| \leq |z| + |w|$.

11.5.2 DE MOIVRE'S THEOREM

We used the method of mathematical induction to prove De Moivre's theorem for the case where n was a positive integer.

i.e., $z^n = [\cos \theta + i \sin \theta]^n = \cos(n\theta) + i \sin(n\theta)$, where n is a positive integer

We now proceed with the case where n is a negative integer and then where n is a rational number.

Case 1. n is a negative integer

If n is a negative integer, put $n = -m$, where m is a positive integer.

Then, $z^n = z^{-m} = \frac{1}{z^m} = \frac{1}{\cos(m\theta) + i \sin(m\theta)} = \frac{1}{\cos(m\theta) + i \sin(m\theta)} \times \frac{\cos(m\theta) - i \sin(m\theta)}{\cos(m\theta) - i \sin(m\theta)}$
 $= \frac{\cos(m\theta) - i \sin(m\theta)}{1}$

MATHEMATICS – Higher Level (Core)

Then, as $\cos(-x) = \cos(x)$ and $\sin(-x) = -\sin(x)$ we have have that

$$\cos(m\theta) - i\sin(m\theta) = \cos(-m\theta) + i\sin(-m\theta) = \cos(n\theta) + i\sin(n\theta).$$

Therefore, $z^n = \cos(n\theta) + i\sin(n\theta)$ for n being a negative integer.

Case 2. n is a rational number

As we have looked at integers, we now consider rational numbers of the form $\frac{p}{q}$.

So, let $n = \frac{p}{q}$, $q \neq 0$ where p and q are integers.

Then, we have $\left[\cos\left(\frac{p}{q}\theta\right) + i\sin\left(\frac{p}{q}\theta\right)\right]^q = \cos(p\theta) + i\sin(p\theta) = [\cos\theta + i\sin\theta]^p$

Therefore, $\cos\left(\frac{p}{q}\theta\right) + i\sin\left(\frac{p}{q}\theta\right)$ is one of the values of $(\cos\theta + i\sin\theta)^{p/q}$. In fact it is one of the q th roots of $[\cos\theta + i\sin\theta]^p$. And so, the theorem is proved for all rational values of n .

11.5.3 FUNDAMENTAL THEOREM OF ALGEBRA

The fundamental theorem of algebra states that every polynomial equation $P(z) = 0$ where $P(z)$ is of degree n , and n is a positive integer has a solution, say, z_1 such that $P(z_1) = 0$.

Then, by the factor theorem, it must be the case that $(z - z_1)$ is a factor of $P(z)$.

Therefore, we have that $P(z) = (z - z_1)P_{n-1}(z) = 0$ where $P_{n-1}(z)$ is itself a polynomial of degree $n - 1$.

So, applying the fundamental theorem again, the equation $P_{n-1}(z) = 0$ also has a solution, say z_2 , so that $P(z) = (z - z_1)(z - z_2)P_{n-2}(z) = 0$ where $P_{n-2}(z)$ is a polynomial of degree $n - 2$.

Continuing in this manner, after n applications we have that

$$P(z) = (z - z_1)(z - z_2)\dots(z - z_n)P_0(z)$$

where $P_0(z)$ is a constant.

And so, we find that there are n solutions, namely, z_1, z_2, \dots, z_n to the polynomial equation $P(z) = 0$. Notice also that the theorem does not tell us if the solutions are distinct – it simply tells us that there are n solutions.

11.5.4 CONJUGATE ROOT THEOREM

From the fundamental theorem of algebra we have that $P(z) = 0$. Then, it must be the case that

$\overline{P(z)} = \overline{0} \Rightarrow \overline{P(z)} = 0$. Let $P(z) = a_n z^n + a_{n-1} z^{n-1} + \dots + a_1 z + a_0$ so that

$$\begin{aligned}\overline{P(z)} &= \overline{a_n z^n + a_{n-1} z^{n-1} + \dots + a_1 z + a_0} = \overline{a_n z^n} + \overline{a_{n-1} z^{n-1}} + \dots + \overline{a_1 z} + \overline{a_0} \\ &= a_n \bar{z}^n + a_{n-1} \bar{z}^{n-1} + \dots + a_1 \bar{z} + a_0 \\ &= a_n \bar{z}^n + a_{n-1} \bar{z}^{n-1} + \dots + a_1 \bar{z} + a_0 \\ &= P(\bar{z})\end{aligned}$$

And so, as $\overline{P(z)} = 0 \Rightarrow P(\bar{z}) = 0$. That is, \bar{z} is also a solution.

12.1 MATHEMATICAL INDUCTION

12.1.1 THE PRINCIPLES OF MATHEMATICAL INDUCTION AND PROOFS

Induction is an indirect method of proof which is used in cases where a direct method is either not possible or not convenient. It involves the derivation of a general rule from one or more particular cases. i.e., the general rule is *induced*. This is the opposite to deduction, where you use the general rule to provide detail about a particular case. For example, we know that 60 is divisible by 1, 2, 3, 4, 5 and 6, but does it follow that 60 is divisible by all positive integers?

EXAMPLE 12.1

Consider the pattern:

$$\begin{aligned} 1 &= 1^2 \\ 1 + 3 &= 2^2 \\ 1 + 3 + 5 &= 3^2 \\ 1 + 3 + 5 + 7 &= 4^2 \end{aligned}$$

The pattern shows that the sum of the first two positive odd integers is a perfect square, the sum of the first three positive odd integers is a perfect square and the sum of the first four positive odd integers is a perfect square. Can we then say, based on the first few lines of this pattern, that:

$$1 + 3 + 5 + 7 + \dots + (2n - 1) = n^2$$

i.e., the sum of the first n odd positive integers is a perfect square, n^2 ?

Solution

This can be checked, as the positive odd integers form an arithmetic progression with $a = 1$ and $d = 2$. The sum of the first n terms is given by

$$\begin{aligned} S_n &= \frac{n}{2}(a + l) \text{ where } a \text{ is the first term, } l \text{ is the last term} \\ &= \frac{n}{2}(1 + 2n - 1) \\ &= n^2 \end{aligned}$$

In this case the general result was easy to guess, but remember that a guess is not a proof. Thankfully in this example we had a method (sum of an AP) to verify our guess. This will not always be the case.

Consider the expression $4n^3 - 18n^2 + 32n - 15$ for values of n from 1 to 4 as shown in the table below:

n	1	2	3	4
$4n^3 - 18n^2 + 32n - 15$	3	9	27	81

The expression appears to produce the successive powers of 3, and so we could assume, based on the results in this table, that $4n^3 - 18n^2 + 32n - 15 = 3^n$.

MATHEMATICS – Higher Level (Core)

Can we then say that this will always be the case, and if so, what would you predict the value of the expression to be when $n = 5$? Check to see if your prediction is correct.

Many formulas which we may guess or develop from simple cases can be proved using the **principle of mathematical induction**. This method of proof relies upon a similar principle to that of ‘domino stacking’. In the process of domino stacking, one domino is first pushed over, thus causing a series of dominoes to fall. Before each successive domino will fall, the preceding domino must fall.

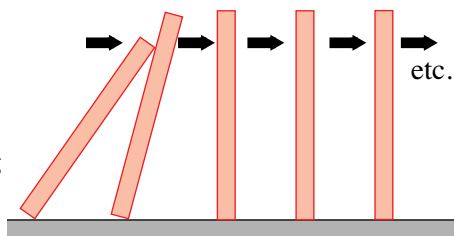

With induction, for each expression to be true, the expression before it must also be true. The process can be summarised into four steps:

Step 1:

the first expression must be true (*the first domino falls*)

Step 2:

assuming that a general expression is true (*assume that some domino in the series falls*)

Step 3:

prove that the next expression is true (*prove that the next domino in the series falls*)

Step 4:

if all of these events happen then we know by induction that all of the expressions are true and thus the original formula is true (*all the dominoes will fall*).

EXAMPLE 12.2

Prove by induction that the sum of the first n odd numbers is n^2 .

That is, $1 + 3 + 5 + 7 + \dots + (2n - 1) = n^2$ for all $n \geq 1$.

Solution

First we need to state what our proposition is. We do this as follows:

Let $P(n)$ be the proposition that $1 + 3 + 5 + 7 + \dots + (2n - 1) = n^2$ for all $n \geq 1$.

Next we proceed with our four steps:

Step 1:

test for $n = 1$

$$\text{LHS} = 1$$

$$\text{RHS} = 1^2$$

$$= 1$$

$$\therefore \text{LHS} = \text{RHS}$$

\therefore the proposition $P(n)$ is true for $n = 1$ (the first domino falls!)

Step 2:

assume that $P(n)$ is true for $n = k$ (a general domino falls)

$$\text{i.e., } 1 + 3 + 5 + 7 + \dots + (2k - 1) = k^2$$

Step 3:

test the proposition for $n = k + 1$ (prove that the next domino falls)

$$\text{i.e., we wish to prove that } 1 + 3 + 5 + \dots + (2k - 1) + \{2(k + 1) - 1\} = (k + 1)^2$$

Now,

$$\text{LHS} = 1 + 3 + 5 + \dots + (2k - 1) + (2k + 1)$$

$$= k^2 + (2k + 1) \text{ [as } 1 + 3 + 5 + \dots + (2k - 1) = k^2 \text{ from Step 2]}$$

$$= (k + 1)^2$$

$$= \text{RHS} \therefore P(n) \text{ is true for } n = k + 1$$

Step 4: Thus, if the proposition is true for $n = k$ (Step 2), then it is true for $n = k + 1$. As it is true for $n = 1$, then it must be true for $n = 1 + 1$ ($n = 2$). As it is true for $n = 2$ then it must hold for $n = 2 + 1$ ($n = 3$) and so on for all positive integers n .

An alternative way of looking at mathematical induction is to think of the problem as a series of assertions. If the first assertion is true, and then each assertion which is true is followed by a true assertion, then all of the assertions in the sequence are true.

EXAMPLE 12.3

Prove that the formula $1 + 2 + 3 + \dots + n = \frac{1}{2}n(n + 1)$ is true for all positive integral n .

**S
o
l
u
t
i
o
n**

Step 1: The formula is actually a series of assertions:

$$n = 1: \quad 1 \quad = \frac{1}{2} \times 1 \times 2$$

$$n = 2: \quad 1 + 2 \quad = \frac{1}{2} \times 2 \times 3$$

$$n = 3: \quad 1 + 2 + 3 \quad = \frac{1}{2} \times 3 \times 4 \text{ etc.}$$

The first assertion is obviously true so we now need to prove that the assertion following each true assertion is itself true.

Step 2: Suppose the k^{th} assertion is true, i.e., $1 + 2 + 3 + \dots + k = \frac{k(k + 1)}{2}$

Step 3: Now add the $(k + 1)^{\text{th}}$ term i.e., $k + 1$ to both sides of this equation, obtaining

$$\begin{aligned} 1 + 2 + 3 + \dots + k + (k + 1) &= \frac{k(k + 1)}{2} + (k + 1) \\ &= \frac{k(k + 1) + 2(k + 1)}{2} \\ &= \frac{(k + 1)(k + 2)}{2} \end{aligned}$$

Step 4: But this is equivalent to the $(k + 1)^{\text{th}}$ assertion, which is true if the k^{th} assertion is true. We have thus shown that the assertion following each true assertion is also true, and thus by mathematical induction the formula given is true for all n .

EXAMPLE 12.4

Prove by induction that $1^2 + 2^2 + 3^2 + \dots + n^2 = \frac{1}{6}n(n + 1)(2n + 1)$.

**S
o
l
u
t
i
o
n**

Let $P(n)$ be the proposition that $1^2 + 2^2 + 3^2 + \dots + n^2 = \frac{1}{6}n(n + 1)(2n + 1)$ for $n \geq 1$.

Step 1: $P(n)$ is true for $n = 1$ since $1^2 = \frac{1}{6} \times 1 \times 2 \times 3 = 1$ i.e., L.H.S = R.H.S

MATHEMATICS – Higher Level (Core)

Step 2: Assume that $P(n)$ is true for $n = k$,

$$\text{i.e., } 1^2 + 2^2 + 3^2 + \dots + k^2 = \frac{1}{6}k(k+1)(2k+1)$$

Step 3: Test the result for $n = k + 1$

Adding the $(k + 1)^{\text{th}}$ term i.e., $(k + 1)^2$ to both sides gives:

$$\begin{aligned}1^2 + 2^2 + 3^2 + \dots + k^2 + (k + 1)^2 &= \frac{1}{6}k(k + 1)(2k + 1) + (k + 1)^2 \\ &= \frac{1}{6}(k + 1)\{k(2k + 1) + 6(k + 1)\} \\ &= \frac{1}{6}(k + 1)(2k^2 + 7k + 6) \\ &= \frac{1}{6}(k + 1)(k + 2)(2k + 3) \\ &= \frac{1}{6}(k + 1)[(k + 1) + 1][2(k + 1) + 1]\end{aligned}$$

i.e., it is of the form $\frac{1}{6}a(a + 1)(2a + 1)$ where $a = k + 1$.

Step 4: Which is the $(k + 1)^{\text{th}}$ assertion. Thus, if the proposition is true for $n = k$, then it is true for $n = k + 1$. As it is true for $n = 1$, then it must be true for $n = 1 + 1$ ($n = 2$). As it is true for $n = 2$ then it must hold for $n = 2 + 1$ ($n = 3$) and so on for all positive integers n .

So, by the principle of mathematical induction, $P(n)$ is true for all $n \geq 1$, where n is an integer.

EXERCISES 12.1

1. Prove by induction that for all n

(a) $1 + 4 + 7 + \dots + (3n - 2) = \frac{1}{2}n(3n - 1)$

(b) $1 + 5 + 9 + \dots + (4n - 3) = n(2n - 1)$

(c) $2 + 4 + 6 + \dots + 2n = n(n + 1)$

(d) $5 + 10 + 15 + \dots + 5n = \frac{5}{2}n(n + 1)$

(e) $6 + 12 + 18 + \dots + 6n = 3n(n + 1)$

(f) $1 + 2 + 4 + 8 + \dots + 2^{n-1} = 2^n - 1$

(g) $1 + r + r^2 + \dots + r^{n-1} = \frac{1 - r^n}{1 - r}$

(h) $1^2 + 3^2 + 5^2 + \dots + (2n - 1)^2 = \frac{1}{3}n(4n^2 - 1)$

(i) $1^2 - 2^2 + 3^2 - \dots + (-1)^{n-1}n^2 = \frac{1}{2}(-1)^{n-1}n(n + 1)$

12.2 FURTHER EXAMPLES PART 1

In this section we consider simple propositions involving divisibility and inequalities.

EXAMPLE 12.5

Prove that $9^n - 1$ is divisible by 8 for all $n \geq 1$ where n is an integer.

S
o
i
l
u
t
i
o
n

Let $P(n)$ be the proposition that $9^n - 1 \mid 8$ (i.e., $9^n - 1$ is divisible by 8) for all $n \geq 1$.

Step 1: The proposition is true when $n = 1$ since $9^1 - 1 = 8$ which is divisible by 8

Step 2: Assume $P(n)$ holds true for $n = k$, i.e., assume that $9^k - 1 = 8m$ where m is an integer.

Step 3: Prove $P(n)$ is true for $n = k + 1$. i.e., prove that $9^{k+1} - 1$ is divisible by 8

$$\begin{aligned} \text{Now } 9^{k+1} - 1 &= 9(9^k) - 1 \\ &= 9(8m + 1) - 1 \text{ [as } 9^k = 8m + 1 \text{ (from Step 2)]} \\ &= 72m + 8 \\ &= 8(9m + 1) \text{ which is divisible by 8} \end{aligned}$$

Therefore, $P(n)$ is true for $n = k + 1$.

Step 4: That is, if the proposition holds for $n = k$, it also holds for $n = k + 1$. As it is true for $n = 1$ it is then true for $n = 2$, and so on, and thus the proposition is true for all $n \geq 1$.

EXAMPLE 12.6

Prove by induction that $2^n > n$ for all $n \geq 1$.

S
o
i
l
u
t
i
o
n

Let $P(n)$ be the proposition that $2^n > n$ for all $n \geq 1$.

Step 1: $P(n)$ is true when $n = 1$ since L.H.S = $2^1 = 2 > 1 =$ R.H.S

Step 2: Assume that $P(n)$ holds for $n = k$; i.e., that $2^k > k$

Step 3: Prove that $P(n)$ is true for $n = k + 1$ i.e., show that $2^{k+1} > k + 1$.

$$\begin{aligned} \text{From Step 2., above, } 2^k &> k \\ 2 \times 2^k &> 2k \text{ [multiplying both sides by 2]} \end{aligned}$$

$$\text{But, } 2 \times 2^k = 2^{k+1} \quad \therefore 2^{k+1} > 2k$$

Now, $k \geq 1$ so $2k = k + k \geq k + 1$ and hence $2^{k+1} > k + 1$
i.e. $P(n)$ holds for $n = k + 1$ if it holds for $n = k$.

Step 4: Thus as $P(n)$ holds for $n = 1$, it holds for $n = 1 + 1$ and so on for all values of $n \geq 1$.

EXAMPLE 12.7

Prove by induction that $3^n > 1 + 2n$ for $n > 1$.

S When dealing with inequalities it is often useful to re-formulate the question and show that the given expression is greater or less than zero (as required).

I Let $P(n)$ be the proposition $3^n > 1 + 2n$ for $n > 1$.

E **Step 1:** First we rearrange $3^n > 1 + 2n$ as $3^n - 2n - 1 > 0$.
Next we test for $n = 2$.
L.H.S = $3^2 - 2 \times 2 - 1 = 4 > 0 =$ R.H.S
Thus $P(n)$ is true for $n = 2$

Step 2: Assume that $P(n)$ is true for $n = k$, i.e., assume that $3^k - 2k - 1 > 0$

Step 3: Prove $P(n)$ is true for $n = k + 1$ i.e. show that $3^{k+1} - 2(k+1) - 1 > 0$
LHS = $3^{k+1} - 2(k+1) - 1$
= $3 \times 3^k - 2k - 3$
= $3 \times 3^k - 6k - 3 + 4k$
= $3(3^k - 2k - 1) + 4k$
> 0 [since $3^k - 2k - 1 > 0$ (from Step 2) and $4k > 0$]

Step 4: Hence if the proposition holds for $n = k$, it also holds for $n = k + 1$. As it is true for $n = 2$ it is then true for $n = 3$, and so on.
 \therefore the proposition $P(n)$ is true for all $n > 1$.

EXERCISES 12.2

- 1.** By induction, prove that
- (a) $9^{n+2} - 4^n$ is divisible by 5 for all $n \geq 1$
 - (b) $n^3 - n$ is divisible by 3 for all $n > 1$
 - (c) $n^3 + 2n$ is a multiple of 3 for all $n \geq 1$
 - (d) $7^n + 2$ is divisible by 3 for all $n \geq 1$
 - (e) $9^{n+1} - 8n - 9$ is divisible by 64 for all $n \geq 1$
 - (f) $2^n \geq 1 + n$ for all $n \geq 1$
 - (g) $n + 1 < 3n$ for all $n \geq 1$
 - (h) $1 + n^2 < (1 + n)^2$ for all $n \geq 1$
 - (i) $n < 1 + n^2$ for all $n \geq 1$
 - (j) $7^n - 3^n, n \geq 1$ is divisible by 4
[Hint: $7^{k+1} - 3^{k+1} = (7^{k+1} - 7 \times 3^k) + (7 \times 3^k - 3^{k+1})$]

12.3 FURTHER EXAMPLES PART 2

We now consider more difficult propositions involving inequalities, divisibility and sums.

EXAMPLE 12.8

Prove by induction that $n^3 + 5n$ is divisible by 6 for all $n \geq 1$.

S
o
i
l
u
t
i
o
n

Let $P(n)$ be the proposition that $n^3 + 5n$ is divisible by 6 for all $n \geq 1$.

Step 1: Test for $n = 1$

$1^3 + 5 \times 1 = 6$ which is divisible by 6 and so the proposition is true for $n = 1$

Step 2: Let $P(n)$ be true for $n = k$, i.e., $\frac{k^3 + 5k}{6} = m \Leftrightarrow k^3 + 5k = 6m$, m is an integer.

Step 3: Test for $n = k + 1$

$$\begin{aligned} (k+1)^3 + 5(k+1) &= k^3 + 3k^2 + 3k + 1 + 5k + 5 \\ &= (k^3 + 5k) + 3k^2 + 3k + 6 \\ &= 6m + 3k^2 + 3k + 6 \text{ [from Step 2]} \\ &= 6m + 6 + 3k(k+1) \end{aligned}$$

Now $k(k+1)$ is an even number and thus it has a factor of 2 (the product of two consecutive integers is even). Thus the product $3k(k+1)$ can be written as $3 \times 2 \times q$ where q is the quotient of $k(k+1)$ and 2.

$$\begin{aligned} \therefore \text{LHS} &= 6m + 6 + 6q \\ &= 6(m + 1 + q) \text{ which is divisible by 6} \end{aligned}$$

Step 4: Thus, if the proposition is true for $n = k$ then it is true for $n = k + 1$ as proved. As it is true for $n = 1$, then it must be true for $n = 1 + 1$ ($n = 2$). As it is true for $n = 2$ then it must hold for $n = 2 + 1$ ($n = 3$) and so on for all positive integers n .

That is, by the principle of mathematical induction $P(n)$ is true.

EXAMPLE 12.9

Prove by induction that $\sin(x + 180^\circ \times n) = (-1)^n \sin(x)$ for all $n \in \mathbb{Z}^+$.

S
o
i
l
u
t
i
o
n

Let $P(n)$ be the proposition $\sin(x + 180^\circ \times n) = (-1)^n \sin(x)$ for all $n \in \mathbb{Z}^+$.

Step 1: The proposition is true when $n = 1$ as

$$\begin{aligned} \sin(x + 180^\circ) &= \sin x \cos(180^\circ) + \cos x \sin(180^\circ) \\ &= (-1) \sin x \end{aligned}$$

Step 2: Assume that $P(n)$ is true for $n = k$, i.e., assume that:

$$\sin(x + 180^\circ \times k) = (-1)^k \sin(x)$$

MATHEMATICS – Higher Level (Core)

Step 3:

Now, to prove that $P(n)$ is true for $n = k + 1$

$$\begin{aligned}\sin[x + (k + 1) \times 180^\circ] &= \sin[(x + k \times 180^\circ) + 180^\circ] \\ &= \sin(x + k \times 180^\circ) \cos 180^\circ + \cos(x + k \times 180^\circ) \sin 180^\circ \\ &= (-1) \sin(x + k \times 180^\circ) \\ &= (-1) (-1)^k \sin x \text{ [from Step 2]} \\ &= (-1)^{k+1} \sin x\end{aligned}$$

i.e. $P(n)$ holds for $n = k + 1$ if it holds for $n = k$.

Step 4:

Thus, if the proposition is true for $n = k$ then it is true for $n = k + 1$ as proved. As it is true for $n = 1$, then it must be true for $n = 1 + 1$ ($n = 2$). As it is true for $n = 2$ then it must hold for $n = 2 + 1$ ($n = 3$) and so on for all positive integers n .

That is, by the principle of mathematical induction, $P(n)$ is true.

EXAMPLE 12.10

$$\text{Prove that } \sum_{r=1}^n (4r - 6) = 2n(n - 2) \text{ for all } n \in \mathbb{Z}^+.$$

Solution

Let $P(n)$ be the proposition that $\sum_{r=1}^n (4r - 6) = 2n(n - 2)$ for all $n \in \mathbb{Z}^+$

However, when dealing with sigma notation it can be helpful to write the first few terms of the sequence:

$$\sum_{r=1}^n (4r - 6) = -2 + 2 + 6 + 10 + \dots + (4n - 6) = 2n(n - 2).$$

Step 1:

$P(n)$ is true for $n = 1$ since L.H.S = $4 \times 1 - 6 = 2 \times (1 - 2) = -2 = \text{R.H.S.}$

Step 2:

Assume that $P(n)$ is true for $n = k$, i.e., $\sum_{r=1}^k (4r - 6) = 2k(k - 2)$.

Step 3:

Test $P(n)$ for $n = k + 1$:

Adding the $(k + 1)^{\text{th}}$ term, $[4(k + 1) - 6]$ to both sides gives

$$\begin{aligned}\sum_{r=1}^k (4r - 6) + [4(k + 1) - 6] &= 2k(k - 2) + [4(k + 1) - 6] \text{ [from Step 2]} \\ &= 2k^2 - 4k + 4k - 2 \\ &= 2(k^2 - 1) \\ &= 2(k + 1)(k - 1) \\ &= 2(k + 1)[(k + 1) - 2]\end{aligned}$$

which is the $(k + 1)^{\text{th}}$ assertion.

That is, $P(n)$ is true for $n = k + 1$.

Step 4:

Thus, if the proposition is true for $n = k$, then it is true for $n = k + 1$. As it is true for $n = 1$, then it must be true for $n = 1 + 1$ ($n = 2$). As it is true for $n = 2$ then it must

hold for $n = 2 + 1$ ($n = 3$) and so on for all positive integers n .

That is, by the principle of mathematical induction, $P(n)$ is true.

EXERCISES 12.3

1. Prove the following using the principle of mathematical induction for all $n \in \mathbb{Z}^+$.

(a)
$$\sum_{r=1}^n \frac{1}{(2r-1)(2r+1)} = \frac{n}{2n+1}$$

(b)
$$\sum_{r=1}^n (2r-1)^3 = n^2(2n^2-1)$$

(c)
$$\sum_{r=1}^n 5^r = \frac{1}{4}(5^{n+1}-5)$$

(d)
$$2 + 2^2 + 2^3 + \dots + 2^n = 2(2^n - 1)$$

(e)
$$1 + 3 + 9 + \dots + 3^{n-1} = \frac{1}{2}(3^n - 1)$$

(f)
$$1 + \frac{1}{2} + \frac{1}{2^2} + \dots + \frac{1}{2^{n-1}} = 2 - 2^{1-n}$$

(g)
$$1.1 + 2.3 + 3.5 + \dots + n(2n-1) = \frac{1}{6}n(n+1)(4n-1)$$

(h)
$$1.1 + 3.2 + 5.4 + \dots + (2n-1)2^{n-1} = 3 + 2^n(2n-3)$$

(i)
$$1.3.5 + 2.4.6 + \dots + n(n+2)(n+4) = \frac{1}{4}n(n+1)(n+4)(n+5)$$

(j)
$$\frac{1}{2.3} + \frac{1}{3.4} + \dots + \frac{1}{(n+1)(n+2)} = \frac{n}{2(n+2)}$$

(k)
$$\frac{1}{1.3} + \frac{1}{2.4} + \dots + \frac{1}{n(n+2)} = \frac{3}{4} - \frac{2n+3}{2(n+1)(n+2)}$$

(l) $(1+x)^n > 1 + nx + nx^2$ for all $n \geq 3, x > 0$

(m) $2^n \geq n^2$ for all integers $n \geq 4$.

(n) $1.1! + 2.2! + 3.3! + \dots + n.n! = (n+1)! - 1$

(o)
$$\frac{0}{1!} + \frac{1}{2!} + \frac{2}{3!} + \dots + \frac{n-1}{n!} = 1 - \frac{1}{n!}$$

(p) $n! > n^2$ for all $n > 3$.

(q) $n^5 - n$ is divisible by 5.

(r)
$$1 + \frac{1}{\sqrt{2}} + \frac{1}{\sqrt{3}} + \dots + \frac{1}{\sqrt{n}} > 2(\sqrt{n+1} - 1), n \geq 1.$$

(s) Prove that the maximum number of points of intersection of $n \geq 2$ lines in a plane is $\frac{1}{2}n(n-1)$.

12.4 FORMING CONJECTURES

Mathematics can be considered to be the study of patterns. A useful ability in maths can be forming a rule to describe a pattern. Of course any rule that we develop must be true in all relevant cases and mathematical induction provides one method of proof.

12.4.1 THE n^{TH} TERM OF A SEQUENCE

EXAMPLE 12.11

Find the number of diagonals that can be drawn in an n -sided convex polygon.

S
o
l
u
t
i
o
n

To begin the solution, consider the possibilities for $n = 3, 4, 5$

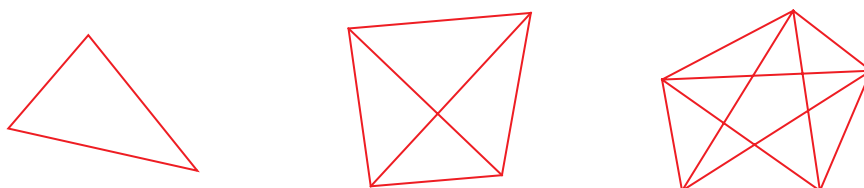

Let d_n represent the number of diagonals in an n -sided polygon. The value for d_n is shown in the table for values of n up to $n = 6$ (construct the next few diagrams in the pattern to verify and extend this table).

n	3	4	5	6
d_n	0	2	5	9

Plotting the points related to the variables n and d_n (above) suggests that the relationship between them could be quadratic, and so we might assume that

$$d_n = an^2 + bn + c.$$

Substituting the first 3 values for n gives:

$$\begin{aligned} n = 3 &\Rightarrow 0 = 9a + 3b + c \\ n = 4 &\Rightarrow 2 = 16a + 4b + c \\ n = 5 &\Rightarrow 5 = 25a + 5b + c \end{aligned}$$

Solving these three equations for a , b and c gives

$$a = \frac{1}{2}, b = -\frac{3}{2}, \text{ and } c = 0 \text{ and thus } d_n = \frac{1}{2}n^2 - \frac{3}{2}n = \frac{n(n-3)}{2}.$$

When $n = 6$, $d_6 = \frac{6(6-3)}{2} = 9$, which corresponds to the tabulated value for $n = 6$ above.

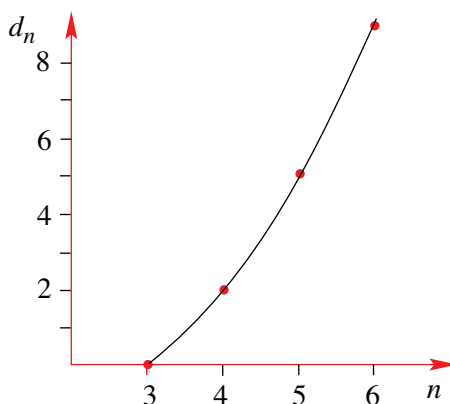

So far we have formed a **conjecture** that the number of diagonals in an n -sided convex polygon is

given by $d_n = \frac{n(n-3)}{2}$. This formula remains a conjecture until we prove that it is true for values of $n \geq 3$.

Proof:

Let $P(n)$ be the proposition that the number of diagonals that can be drawn in an n -sided convex polygon is given by $d_n = \frac{n(n-3)}{2}$ for $n \geq 3$.

Step 1: $P(n)$ is true for $n = 3$ as $d_3 = \frac{3(3-3)}{2} = 0$ which is the number of diagonals in a 3 sided polygon.

Step 2: Assume that $P(n)$ is true for a k -sided polygon i.e., that $d_k = \frac{k(k-3)}{2}$. We consider the effect that adding an extra side will have on the result.

Step 3: Looking at the tabulated values for n and d_n you should see that adding an extra side to an n -sided polygon produces an extra $(n - 1)$ diagonals, and so we can say that

$$\begin{aligned} d_{k+1} &= d_k + \text{the extra diagonals added by the extra side} \\ &= d_k + (k - 1) \\ &= \frac{k(k-3)}{2} + (k - 1) \\ &= \frac{k(k-3) + 2(k-1)}{2} \quad \left[= \frac{k^2 - k - 2}{2} \right] \\ &= \frac{(k+1)(k-2)}{2} \\ &= \frac{(k+1)[(k+1)-3]}{2} \end{aligned}$$

Step 4: Which is the $(k + 1)^{th}$ assertion.

Thus, if the proposition is true for $n = k$, then it is true for $n = k + 1$. As it is true for $n = 3$, then it must be true for $n = 3 + 1$ ($n = 4$). As it is true for $n = 4$ then it must hold for $n = 4 + 1$ ($n = 5$) and so on for all integers $n \geq 3$.

That is, by the principle of mathematical induction, $P(n)$ is true.

Another useful way to find the general term from a given sequence is called the *Method of Differences*. This method is useful when the general term of a sequence can be expressed as a polynomial.

To illustrate this method, consider the sequence 2, 12, 36, 80, 150, 252, Our aim is to find an expression for the n^{th} term i.e. U_n .

Form a *difference array* as shown on the next page. Each entry in the difference rows of the array is found, as the name suggests, from the difference between the two terms above.

MATHEMATICS – Higher Level (Core)

Sequence	2		12		36		80		150		252		...
1 st differences		10		24		44		70		102		...	
2 nd differences			14		20		26		32		...		
3 rd differences				6		6		6		...			

Notice that eventually there will be a line where all differences are equal (only if the relationship really is a polynomial). For any polynomial sequence, this line of equal differences is not coincidental and will always occur. Construct a difference array for the first 6 terms of the polynomials defined by

$$P(n) = n^4 - n^3 \text{ and } P(n) = 3n^3 - 5n^2 - 1.$$

From these arrays, you should notice that the line of equal differences occurs in the 4th row for the polynomial of degree 4, and the 3rd row for the polynomial of degree 3.

Generalising, we can say that a sequence having its n^{th} differences equal, can be expressed as a polynomial of degree n .

We now need to look at how this generalisation can help us find the n^{th} term of a given sequence.

Consider the general sequence with terms $U_1, U_2, U_3, \dots, U_n$, then the difference array is as follows:

Sequence	U_1		U_2		U_3		U_4		$U_5 \dots$
1 st differences		$\Delta_1 U_1$		$\Delta_1 U_2$		$\Delta_1 U_3$		$\Delta_1 U_4$...
2 nd differences			$\Delta_2 U_1$		$\Delta_2 U_2$		$\Delta_2 U_3$...	
3 rd differences				$\Delta_3 U_1$		$\Delta_3 U_2$		$\Delta_3 U_3$...

Note that $\Delta_i U_j$ represents the j^{th} difference in the i^{th} row of the array

Each entry in the given array is the sum of the term preceding it and the term below it to the left.

Thus

$$\begin{aligned}
 U_2 - U_1 = \Delta_1 U_1 &\Rightarrow U_2 = U_1 + \Delta_1 U_1 \\
 U_3 - U_2 = \Delta_1 U_2 &\Rightarrow U_3 = U_2 + \Delta_1 U_2 \\
 \Delta_1 U_2 - \Delta_1 U_1 = \Delta_2 U_1 &\Rightarrow \Delta_1 U_2 = \Delta_1 U_1 + \Delta_2 U_1 \\
 &\text{etc.}
 \end{aligned}$$

Now

$$\begin{aligned}
 U_3 &= U_2 + \Delta_1 U_2 \\
 &= (U_1 + \Delta_1 U_1) + (\Delta_1 U_1 + \Delta_2 U_1) \text{ [from the above expressions for } U_2 \text{ and } \Delta_1 U_2 \text{]} \\
 &= U_1 + 2\Delta_1 U_1 + \Delta_2 U_1
 \end{aligned}$$

Similarly it can be shown that $U_4 = U_1 + 3\Delta_1 U_1 + 3\Delta_2 U_1 + \Delta_3 U_1$, and following this method we can form an expression for each term of the sequence in terms of U_1 .

Looking at the expressions for U_2, U_3 , and U_4 notice that the numerical coefficients are those of the binomial theorem. Note though that the coefficients for the 4th term are those of the binomial

expansion of exponent 3, the coefficients for the 3^{rd} term are those of the binomial expansion of exponent 2.

We can now form a conjecture that an expression for U_n in terms of U_1 is given by

$$U_n = U_1 + (n-1)\Delta_1 U_1 + \binom{n-1}{2} \Delta_2 U_1 + \dots + \binom{n-1}{r} \Delta_r U_1 + \dots + \Delta_{n-1} U_1$$

The proof of this result is left as an exercise for the student [Hint: recall from work on the Binomial theorem that $\binom{n}{r} + \binom{n}{r-1} = \binom{n+1}{r}$].

Applying this to our earlier sequence of 2, 12, 36, 80, 150, 252, ...

For this sequence the row of equal differences was the third, thus we utilise the terms of U_n up to $\Delta_3 U_1$.

$U_1 = 2$, $\Delta_1 U_1 = 10$, $\Delta_2 U_1 = 14$, $\Delta_3 U_1 = 6$ and so

$$\begin{aligned} U_n &= 2 + 10(n-1) + 14\binom{n-1}{2} + 6\binom{n-1}{3} \\ &= 2 + 10(n-1) + 14\frac{(n-1)(n-2)}{1.2} + 6\frac{(n-1)(n-2)(n-3)}{1.2.3} \\ &= 2 + 10(n-1) + 7(n^2 - 3n + 2) + (n^3 - 6n^2 + 11n - 6) \\ &= n^3 + n^2 \end{aligned}$$

All that now remains is to prove this result true for all values of $n \geq 1$. This is left for the student.

EXERCISES 12.4.1

1. Deduce an expression for the n^{th} term in each sequence below.

- | | |
|---|---|
| (a) 4, 6, 8, 10, ... | (b) 3, 8, 13, 18, ... |
| (c) $1, \frac{1}{2}, \frac{1}{3}, \frac{1}{4}, \dots$ | (d) 3, 9, 27, 81, ... |
| (e) 2, 5, 10, 17, 26, ... | (f) $\frac{1}{2}, \frac{2}{3}, \frac{3}{4}, \frac{4}{5}, \dots$ |
| (g) $2, \frac{3}{2}, \frac{4}{3}, \frac{5}{4}, \dots$ | (h) $4, 2, 1, \frac{1}{2}, \frac{1}{4}, \dots$ |

2. Find an expression for the n^{th} terms of each sequence below using the method of differences, and then prove your expressions true.

- | | |
|-------------------------------|--|
| (i) 5, 10, 17, 26, 37, ... | (ii) 1, 8, 19, 34, 53, ... |
| (iii) -1, 4, 21, 56, 115, ... | (iv) 5, 2, -13, -55, -145, -310, -583, ... |
| (v) 7, 19, 31, 37, 31, 7, ... | |

12.4.2 THE SUM TO n TERMS OF A SEQUENCE

In an earlier example we were given the task of proving that:

$$1^2 + 2^2 + 3^2 + \dots + n^2 = \frac{1}{6}n(n+1)(2n+1).$$

This was proved to be true, but a further question now arises - from where did the initial expression for the sum of the terms of the sequence come?

Recall from your work on Series and Sequences that given a sequence $u_1, u_2, u_3, \dots, u_n$ the related series is $s_n = u_1 + u_2 + u_3 + \dots + u_n$. Often the sum to n terms of a series can be easily found, especially when the series is an arithmetic or geometric progression.

Our task now is to develop a method of finding an expression for the sum to n terms of *any* given series. The method involved relies upon the result that follows.

If we can find a function $f(n)$ such that $u_n = f(n+1) - f(n)$ then:

$$s_n = u_1 + u_2 + u_3 + \dots + u_n = f(n+1) - f(1)$$

Proof

If we have the function $f(n)$ then: $u_1 = f(2) - f(1)$

$$u_2 = f(3) - f(2)$$

$$u_3 = f(4) - f(3)$$

⋮

$$u_{n-1} = f(n) - f(n-1)$$

$$u_n = f(n+1) - f(n)$$

Adding the respective sides of this together we get:

$$u_1 + u_2 + u_3 + \dots + u_n = \cancel{[f(2) - f(1)]} + \cancel{[f(3) - f(2)]} + \cancel{[f(4) - f(3)]} + \dots + \cancel{[f(n) - f(n-1)]} + [f(n+1) - f(n)]$$

$$\therefore s_n = f(n+1) - f(1)$$

The trick with this procedure is in choosing the correct function $f(n)$. Consideration of the following examples should provide some insight into how this can be done.

EXAMPLE 12.12

Find an expression for the sum to n terms of the series

$$1^2 + 2^2 + 3^2 + \dots + n^2$$

S
o
l
u
t
i
o
n

If u_n is given in terms of a polynomial i.e., $u_n = P(n)$, then let $f(n)$ be a polynomial with degree one more than the degree of $P(n)$.

Hence as $P(n) = n^2$ let $f(n) = an^3 + bn^2 + cn + d$ and then

$$f(n+1) = a(n+1)^3 + b(n+1)^2 + c(n+1) + d$$

Now $u_n = f(n+1) - f(n)$

$$\begin{aligned} \therefore n^2 &= a(n+1)^3 + b(n+1)^2 + c(n+1) + d - [an^3 + bn^2 + cn + d] \\ &= 3an^2 + (3a + 2b)n + (a + b + c) \end{aligned}$$

Equating the coefficients of the powers of n from the left and right sides gives:

$$3a = 1, \quad 3a + 2b = 0, \quad a + b + c = 0$$

Solving gives $a = \frac{1}{3}, b = -\frac{1}{2}, c = \frac{1}{6}$.

Therefore, we have: $f(n) = \frac{1}{3}n^3 - \frac{1}{2}n^2 + \frac{1}{6}n + d$

$$f(n+1) = \frac{1}{3}(n+1)^3 - \frac{1}{2}(n+1)^2 + \frac{1}{6}(n+1) + d$$

$$\begin{aligned} f(1) &= \frac{1}{3} - \frac{1}{2} + \frac{1}{6} + d \\ &= d \end{aligned}$$

Now,

$$\begin{aligned} s_n &= u_1 + u_2 + u_3 + \dots + u_n \\ &= f(n+1) - f(1) \\ &= \frac{1}{3}(n+1)^3 - \frac{1}{2}(n+1)^2 + \frac{1}{6}(n+1) \quad \text{[the 'd' terms cancelled]} \\ &= \frac{n(n+1)(2n+1)}{6} \end{aligned}$$

This formula was proved earlier in this chapter.

EXAMPLE 12.13

Find the sum to n terms of the series $\frac{1}{2} + \frac{1}{4} + \dots + \frac{1}{2^n}$.

**S
o
l
u
t
i
o
n**

Consider $f(n) = \frac{a}{2^n}$ then: $f(n+1) = \frac{a}{2^{n+1}}$

Now $u_n = f(n+1) - f(n)$, i.e. $\frac{1}{2^n} = \frac{a}{2^{n+1}} - \frac{a}{2^n}$

Equating and solving for a gives $a = -2 \therefore f(n+1) = \frac{-2}{2^{n+1}} = -\frac{1}{2^n}, f(1) = -1$

Therefore, $\frac{1}{2} + \frac{1}{4} + \dots + \frac{1}{2^n} = f(n+1) - f(1) = -\frac{1}{2^n} + 1 = 1 - \frac{1}{2^n}$

This result can be proved by induction.

EXAMPLE 12.14

Find the sum of the series $\sin^2\theta + \sin^22\theta + \sin^23\theta + \dots + \sin^2n\theta$.

S
O
L
V
E
D
I
N

We have that $u_n = \sin^2n\theta = \frac{1}{2}(1 - \cos 2n\theta)$ [Using the identity $\cos 2\alpha = 1 - 2\sin^2\alpha$]

$$\text{Then, } s_n = \sum_{r=1}^n \sin^2r\theta = \sum_{r=1}^n \frac{1}{2}(1 - \cos 2r\theta) = \frac{1}{2}n - \frac{1}{2} \sum_{r=1}^n \cos 2r\theta.$$

However, we also have that (using $2\sin\frac{1}{2}(\alpha - \beta)\cos\frac{1}{2}(\alpha + \beta) = \sin\alpha - \sin\beta$)

$$\begin{aligned} \sin\theta \cos 2r\theta &= \sin\frac{1}{2}(2\theta)\cos 2r\theta = \frac{1}{2}[\sin(2r + 1)\theta - \sin(2r - 1)\theta] \\ &= \frac{1}{2}[f(r + 1) - f(r)], \text{ where } f(r) = \sin(2r - 1)\theta \end{aligned}$$

$$\begin{aligned} \text{Therefore, } \sum_{r=1}^n \sin\theta \cos 2r\theta &= \sum_{r=1}^n \frac{1}{2}[\sin(2r + 1)\theta - \sin(2r - 1)\theta] \\ &= \frac{1}{2}[\sin(2n + 1)\theta - \sin\theta] \text{ [Using } f(n + 1) - f(1)\text{]} \end{aligned}$$

$$\begin{aligned} \therefore \sin\theta \sum_{r=1}^n \cos 2r\theta &= \frac{1}{2}[\sin(2n + 1)\theta - \sin\theta] \\ &= \cos(n + 1)\theta \sin n\theta \\ \therefore \sum_{r=1}^n \cos 2r\theta &= \frac{\cos(n + 1)\theta \sin n\theta}{\sin\theta} \end{aligned}$$

$$\text{And so, } s_n = \frac{1}{2}n - \frac{1}{2} \cdot \frac{\cos(n + 1)\theta \sin n\theta}{\sin\theta}.$$

$$\text{That is, } \sin^2\theta + \sin^22\theta + \sin^23\theta + \dots + \sin^2n\theta = \frac{1}{2}\left(n - \frac{\cos(n + 1)\theta \sin n\theta}{\sin\theta}\right).$$

EXERCISES 12.4.2

1. Find the sum to n terms of the sequences below and then prove your results true.

- (a) $2 + 5 + 10 + 17 + \dots + (n^2 + 1)$
- (b) $1 + 8 + 27 + 64 + \dots + n^3$
- (c) $\frac{1}{5} + \frac{1}{25} + \frac{1}{125} + \dots + \frac{1}{5^n}$
- (d) $1^3 + 3^3 + 5^3 + \dots + (2n - 1)^3$
- (e) $1.3 + 2.4 + 3.5 + \dots + n(n + 2)$
- (f) $\frac{1}{1 \cdot 3} + \frac{1}{3 \cdot 5} + \frac{1}{5 \cdot 7} + \dots + \frac{1}{(2n - 1)(2n + 1)}$

For questions 2 to 7, find the required general result and then prove your answer using Mathematical Induction.

2. 1, 3, 6, 10, 15, ... are called triangular numbers.

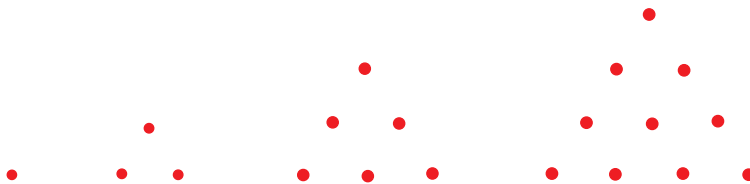

Denoting the n^{th} triangular number as t_n , find a formula for t_n .

3. Find the size of each angle in a regular n -sided polygon.
4. Find the maximum number of pieces that can be formed making n straight cuts across a circular pizza (*pieces don't have to be of equal size*).
5. Find the number of squares of all sizes on an $n \times n$ chess board.
6. Prove that a three digit number is divisible by 3 if the sum of its digits is divisible by 3.
7. The pattern below is formed by taking a single square, and adding a congruent square on each edge. How many squares will there be in the n^{th} repetition of this pattern?

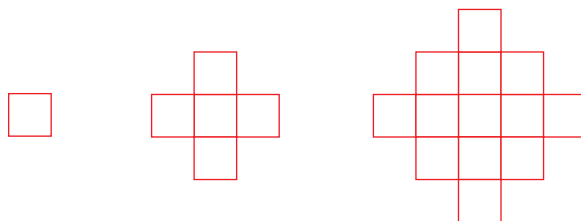

8. In each of these circles, each dot is joined to every other one. Into how many pieces is each circle divided? If a circle is drawn with n dots, what is the maximum number of regions that can be formed if all dots are joined in the same manner?

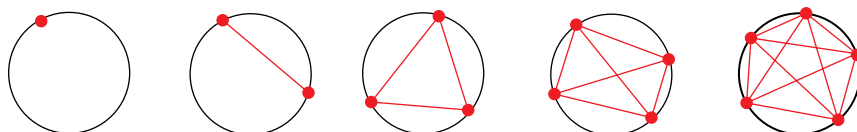

9. You are given five black discs and five white discs which are arranged in a line as shown:



The task is to get all of the black discs to the right hand side and all of the white discs to the left hand side. The only move allowed is to interchange two neighbouring discs.

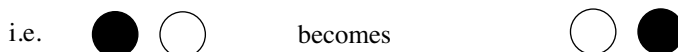

What is the smallest number of moves that need to be made?

MATHEMATICS – Higher Level (Core)

How many moves would it take if we had n black discs and n white discs arranged alternatively?

Suppose the discs are arranged in pairs



How many moves would it take if there were n each of black and white?

Now suppose that you have three colours, black, white and green.



The task here is to get all the black discs to the right, all the green discs to the left and the white discs to the middle. What is the smallest number of moves required if there are n discs of each colour?

10. Prove that $\sin\theta + \sin 3\theta + \dots + \sin(2n-1)\theta = \frac{\sin^2 n\theta}{\sin\theta}$

11. Prove that $\binom{n}{0}^2 + \binom{n}{1}^2 + \binom{n}{2}^2 + \dots + \binom{n}{n}^2 = \frac{(2n)!}{(n!)^2}$

[Hint: consider the coefficient of x^n in the expansion of $(1+x)^n(1+x)^n$]

- 12.** Consider placing a point inside a triangle so that non-intersecting lines are drawn from the point to the vertices of the triangle, creating partitions of the larger triangle into smaller triangles. How many partitioned triangles do we have?

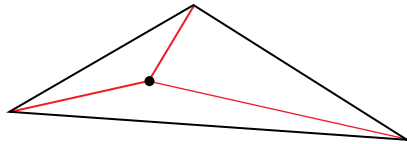

Now consider the same problems as above, but this time with two points inside the larger triangle. How many partitioned triangles do we now have?

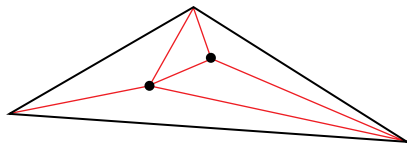

Make a proposition for the above situation when n points are placed inside the triangle. Use the principle of mathematical induction to prove your proposition.

REVISION SET B - PAPER 1 & PAPER 2 STYLE QUESTIONS

- 1.** (a) In the sequence $2, 2\frac{1}{2}, 3, 3\frac{1}{2}, \dots$, what term will the number 96 be?
- (b) In a city there was on average a crime rate every 90 minutes. This represented an increase of 10% over the previous year. In the previous year there was on average a crime every x minutes. Find x .
- (c) Find x given that $3 - 6 + 12 - 24 + \dots + x = -63$.
- (d) A series is defined as $\log_2 3 + \log_2 3^2 + \log_2 3^3 + \log_2 3^4 + \dots$. What is the smallest value of n such that $S_n > 1000$?
- 2.** (a) Given that $\frac{1}{b+c}$, $\frac{1}{a+c}$ and $\frac{1}{a+b}$ are three consecutive terms of an arithmetic sequence. Show that a^2 , b^2 and c^2 are also three consecutive terms of an arithmetic sequence.
- (b) The 3rd term of an A.P is 6 and the 5th term is -4 . Find the sum of the first 10 terms of the A.P.
- 3.** Three towns are positioned so that Blacktown is 15 km north of Acton and Capetown is 32 km north-east of Acton. *Give all answers to 1 d.p.*
- (a) Draw a triangle representing the locations of the three towns Acton, Blacktown and Capetown labelling the towns A, B and C respectively. Making sure to label all distances and angles.
- (b) Calculate the straight-line distance between Blacktown and Capetown.
- (c) Determine the angle BCA.

An aeroplane is 3.0 km directly above Blacktown at point P. The points A, P and C form a triangle.

- (d) Determine how far the plane is from the point A which represents the town Acton.
- (e) Calculate the size of angle APC.
- 4.** Three companies A, B and C are competitors and are keen to compare sales figures for the period July 2003 to June 2004 inclusive.
- Company A had sales of \$35,400 in July 2003 and increased sales by an average 3% per month over the period.
- Company B had sales of \$32,000 in July 2003 and increased sales by an average of \$1859 per month over the period.
- Company C had sales of \$48,000 in July 2003 and unfortunately found that their sales decreased by an average of 8% per month over the period.
- (a) Calculate to the nearest hundred dollars;
- i. the sales figures for each of the companies in June 2004.
 - ii. the total sales figures for each of the companies for the twelve month period July 2003 to June 2004 inclusive.
- (b) Calculate, correct to one decimal place, the average percentage increase in sales per month over the period for company B.
- (c) Assuming that the given sales trends continue beyond June 2004:
- i. calculate how many months from July 2003 Company A will take to reach a total sales target of \$600,000.
 - ii. will Company C ever reach a total sales target of \$600,000? Give reasons.

MATHEMATICS – Higher Level (Core)

- 5.** Given that $w = \frac{3-2i}{-1+i}$, find (a) $|w|$ (b) w^* (c) $Im(w)$
- 6.** (a) In an infinite G.P, the sum of the first three terms is equal to seven eighths of the sum to infinity. Find the common ratio, r .
 (b) A plant is 50 cm high when it is first observed. One week later it has grown 10 cm, and each week thereafter it grows 80% of the previous week's growth. Given that this pattern continues, what will be the plants ultimate height?
- 7.** (a) Show that $\frac{1-\cos 2A}{1+\cos 2A} = \tan^2 A$
 (b) Solve the equation $2\sec^2\theta + \tan\theta - 3 = 0, 0 \leq \theta \leq 180^\circ$.
 (c) Find the exact value of $\tan 105^\circ + \tan 15^\circ$.
- 8.** (a) Evaluate i. $\frac{1}{2!}$ ii. $\frac{2}{3!}$ iii. $\frac{k}{(k+1)!}$
 (b) Prove, using the principle of mathematical induction, that

$$\frac{1}{2!} + \frac{2}{3!} + \frac{3}{4!} + \dots + \frac{n}{(n+1)!} = 1 - \frac{1}{(n+1)!}$$
- 9.** (a) Prove that $\frac{\sin 2x}{1+\cos 2x} = \tan x$.
 (b) Solve $2\cos^2\theta + \sin\theta = 1, 0 \leq \theta \leq 2\pi$.
- 10.** Prove by mathematical induction that $n^3 - n$ is divisible by 6 for all $n \geq 2$.
- 11.** (a) For a certain A.P, $u_3 = 7$ and $u_6 = 16$. Find the value of u_{10} .
 (b) The n th term of the series $5 + 2 + \frac{5}{6} + \dots$ is given by $u_n = \frac{A}{2^n} + \frac{B}{3^n}$.
 i. Find the values of A, B and u_4
 ii. Evaluate $\sum_{n=1}^{\infty} u_n$.
- 12.** (a) Find the square root of $-7 + 24i$.
 (b) Simplify $\frac{(cis(\theta))^9(cis(3\theta))^{-5}}{(cis(-2\theta))^4}$.
 (c) i. Show that $z^n + z^{-n} = 2\cos n\theta$, where z is a complex number.
 ii. Hence solve the equation $3z^4 + 2z^3 + z^2 + 2z + 3 = 0$.
- 13.** (a) Solve for θ if $4\sin^2\theta = 3, 0 \leq \theta \leq 2\pi$.
 (b) Find $\{\theta : \sin^2\theta = \sin\theta, 0 \leq \theta \leq 2\pi\}$
 (c) i. Find R and α so that $\sqrt{3}\cos x - \sin x \equiv R\cos(x + \alpha), R > 0$ and $0 < \alpha < \frac{\pi}{2}$.
 ii. Hence, find $\{x | \sqrt{3}\cos x - \sin x = 1, 0 \leq x \leq 2\pi\}$.

- 14.** Prove by induction that $11^n - 1 \mid 10$ for all positive integers n .
- 15.** (a) If $g(x) = \frac{17}{5 - 3\sin^2 x}$, $x \in \mathbb{R}$, state the greatest and least value of $g(x)$ and the positive values of x for which these occur.
 (b) Solve for θ in the range $]0, 2\pi[$ where $2\sin^2\theta = 3\cos\theta$.
 (c) Prove that $\frac{\sin 2\theta}{1 - \cos 2\theta} = \cot\theta$.
- 16.** The first three terms of a sequence are 68, 62, 56.
 (a) Write a formula for the n th term, u_n
 (b) If the last term of the sequence is p , how many terms are there in the sequence?
 (c) Find a simplified expression for the sum of n terms of the sequence in terms of p , and hence find the value of p that gives the maximum possible sum.
- 17.** Show that $1 + i$ is a root of the polynomial $P(x) = x^3 + x^2 - 4x + 6$ and hence resolve $P(x)$ into irreducible factors over the
 (a) real number field.
 (b) complex number field.
- 18.** In the triangle ABC, $AB = 5$, $BC = 3$, $CA = 4$. D is a point on $[AB]$ such that $\angle BCD = \frac{\pi}{6}$. Find the exact value of CD.
- 19.** Given that $z_1 = \frac{-2+i}{1-3i}$ and $z_2 = \frac{-3+i}{2+i}$, find i. $\arg\left(\frac{z_1}{z_2}\right)$ ii. $\left|\frac{z_1}{z_2}\right|$
- 20.** Two vertical masts BD and CE, each of height h , have their base B and C on level ground with C to the east of B. Point A lies on the same level as B and C and is due south of B. The angle of elevation of D from A is θ and angle DAE = ϕ . If the angle of elevation of E from A is α , show that $\sin\alpha = \sin\theta\cos\phi$.
- 21.** Use mathematical induction to prove $\sum_{r=1}^n r(r+1) = \frac{1}{3}n(n+1)(n+2)$.
- 22.** (a) Solve for θ where $2\tan\theta - 4\cot\theta = \operatorname{cosec}\theta$, $0^\circ \leq \theta \leq 360^\circ$.
 (b) i. Simplify $\frac{\sin\theta}{1 - \cos\theta} + \frac{\sin\theta}{1 + \cos\theta}$.
 ii. Hence solve $\frac{\sin\theta}{1 - \cos\theta} + \frac{\sin\theta}{1 + \cos\theta} = \frac{4}{\sqrt{3}}$, $0 \leq \theta \leq 2\pi$.
- 23.** (a) If $(3+i)z = 4(2-i)$, express z and z^2 in the form $x + iy$ where x and y are real.
 (b) If $a = \frac{3-i}{2+i}$, $b = \frac{7+i}{2-3i}$, find the complex number $\frac{a+b}{a-b}$.
 (c) Find all complex numbers z , such that $z^4 + 3z^3 - 2z^2 + 3z + 1 = 0$.

MATHEMATICS – Higher Level (Core)

24. The complex number w is given by $w = -1 + i\sqrt{3}$. Show that $w^2 = -4 - 2w$ and show that w is a root of the equation $w^3 - 8 = 0$.

25. Prove by mathematical induction, that $81 \times 3^{2n} - 2^{2n}$ is divisible by 5 where $n \in \mathbb{Z}^+$.

26. $\tan^{-1}(4) - \tan^{-1}\left(\frac{3}{5}\right) = k$. Find k .

27. (a) A geometric sequence has a first term 2 and a common ratio 1.5. Find the sum of the first 11 terms.

(b) Find the number of terms of the sequence 3, 7, 11, ... required to sum to 820.

(c) For what values of x will the sum $1 + (1-x) + (1-x)^2 + (1-x)^3 + \dots$ exist?

(d) Find the first four terms of the sequence defined by $u_{n+1} = 2u_n + n$, $u_1 = 1$.

(e) Find the n th term of the sequence defined by the difference equation

$$u_{n+1} = u_n - 3, \text{ with } u_1 = 20.$$

(f) Robyn borrows \$10000 from a bank. Interest at 18% per annum is calculated monthly on the amount of money still owing. Robyn repays \$600 each month. How much does Robyn owe the bank after the first 12 repayments?

28. Let $f(x) = 2x + \frac{\pi}{6}$ and $g(x) = 1 - 3\sin x$.

(a) Find $g(f(0))$.

(b) Write down the maximum value of $g(f(x))$.

29. The sides of a triangle have lengths 7cm, 8cm and 13cm respectively. Find

(a) the size of its largest angle, (b) the area of the triangle.

30. A photographer's tripod stands on a horizontal floor, with its feet A, B and C at the vertices of an equilateral triangle of side length 0.6 metres. Each leg is 1.2 metres long.

The line [AM] meets the side [BC] at right angles where M is the mid-point of [BC]. The point G is the centroid of triangle ABC, that is,

$$AG = \frac{2}{3}AM.$$

(a) Calculate i. the length of [AM]
ii. the length of [AG]

(b) Calculate the height above the floor of the top, V, of the tripod.

(c) Calculate the angle which a leg makes with the floor.

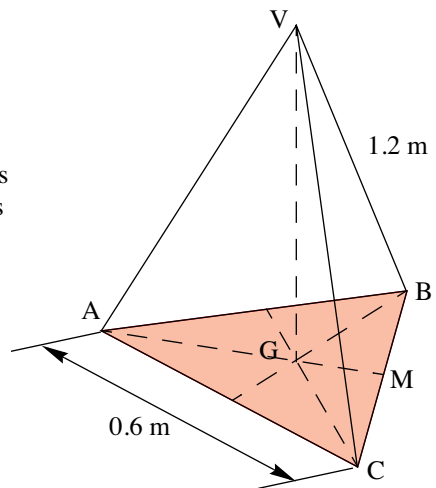

31. (a) Find the values of x between 0 and 2π for which $\sin x = \sqrt{3}\cos x$.

(b) Sketch, on the same set of axes, the graphs of $y = \sin x$ and $y = \sqrt{3}\cos x$ for values of x from 0 to 2π . Hence find $\{x \mid \sin x > \sqrt{3}\cos x, 0 \leq x \leq 2\pi\}$.

- 32.** A rectangular pyramid VABCD has a base measuring 24 cm by 18 cm. Each slant edge measures 17 cm.

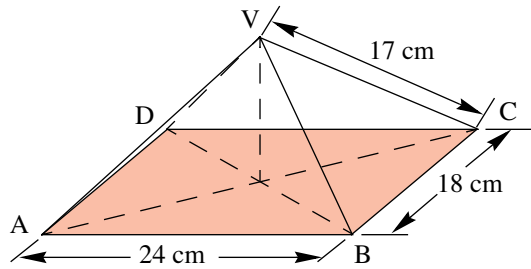

Find

- (a) the height of the pyramid.
 (b) the angle which a slant edge makes with the base.

- 33.** (a) If $z = \sqrt{3} - i$, find $|z|$, $\text{Arg}(z)$, $|z^7|$, $\text{Arg}(z^7)$.
 (b) If $z_1 = 4\text{cis}\left(\frac{2\pi}{3}\right)$ and $z_2 = 2\text{cis}\left(-\frac{5\pi}{6}\right)$, express the following in the form $a + bi$ where a and b are real numbers.

- i. z_1^3 ii. $z_1 z_2$ iii. $\frac{z_1}{z_2}$ iv. z_2^{-5}
 v. \bar{z}_1^4 where \bar{z}_1 is the conjugate of z_1 .

- 34.** (a) Express $z = -1 + \sqrt{3}i$ in polar form.
 State i. $|z^{-5}|$ ii. $\text{Arg}(z^{-5})$. Hence express z^{-5} in Cartesian form.
 (b) Given $z = 1 - i$ is a solution of $z^4 - 2z^3 + 4z^2 - 4z + 4 = 0$, find all complex number solutions.

- 35.** If $\sin\theta = -\frac{3}{5}$ and $\cos\theta < 0$, find $\cos\theta$ and $\tan\theta$ and hence, evaluate $5 - \frac{2}{\sin^2\theta} + \frac{2}{\tan^2\theta}$.

- 36.** (a) Find the values of x which satisfies the equation: $\cos 2\left(x - \frac{\pi}{3}\right) = 0$, $0 \leq x \leq 2\pi$.

- (b) Make use of these values in sketching the graph of $y = \cos 2\left(x - \frac{\pi}{3}\right)$ for $0 \leq x \leq 2\pi$ labelling the intercepts with the axes. Also find one turning point.

- 37.** (a) Mr F. Nurke has been working at the firm of Snyder & Shyster for 6 years. He started work on an annual salary of \$10,000, and each year this has increased by 10%. Find the total amount he has earned with the firm.
 (b) The first term in a geometric sequence is a negative number, the second is 3 and the fourth is 9. Find the first and third terms.

- 38.** (a) The graph on the right represents the function defined by $f(x) = a\cos(bx)$. Find the values of a and b .

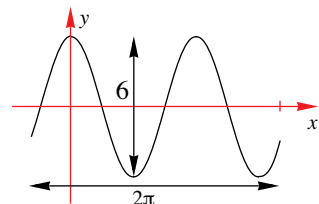

- (b) Find $\left\{x : 2\cos(2x) = \sqrt{3}, \pi < x < \frac{3\pi}{2}\right\}$.

- (c) Find $n(\mathbf{S})$, if $\mathbf{S} = \{x : \sin(3x) = \cos(3x), 0 \leq x \leq \pi\}$

MATHEMATICS – Higher Level (Core)

- 39.** A, P and Q are three points in that order in a straight line. The bearing of P and Q from A is 310° . From another point B, 1 kilometre due west of A, the bearing of P is 053° ; and Q is due north of B.

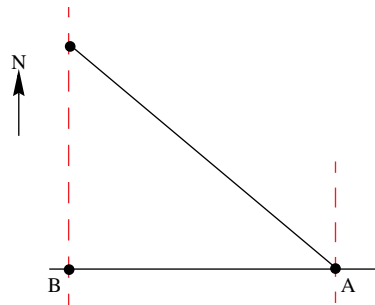

- (a) Copy and complete the diagram, clearly showing the position of P and Q and all relevant angles and distances.
- (b) Calculate, to the nearest metre,
 i. the distance from point P from point B?
 ii. distance from P to Q,

- 40.** A sector OAB is to be cut from a circle of cardboard with radius 25 cm, and then folded so that radii OA and OB are joined to form a cone, with a slant height 25 cm. If the vertical height of the cone is to be 20 cm, what must the angle α° be (in degrees)?

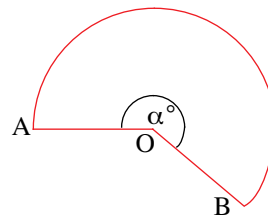

- 41.** A girl walking due east along a straight horizontal road observes a church spire on a true bearing of 076° . After walking 1500 metres further she observes the spire on a true bearing of 067° .

- (a) Draw a diagram for this situation.
 (b) How far is the church from the road (to the nearest metre)?

- 42.** A monument consists of a truncated square pyramid ABCD, EFGH, of height 2.2 metres, surmounted by a square pyramid V ABCD, of height 0.2 metres, as shown in the diagram. The square ABCD has edge 0.5 metres and the square EFGH has edge 0.8 metres.

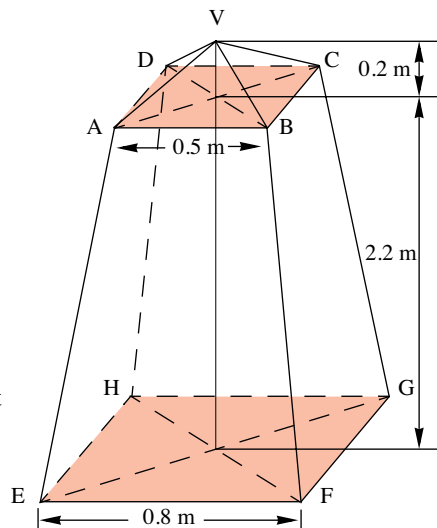

Find:

- (a) the inclination of a sloping triangular face to the base.
 (b) the surface area of one of the sloping triangular faces.
 (c) the total surface area of all the sloping faces of the monument.
 (d) the monument needs to be rendered with two coats of a cement mix. The cost per square metre for this cement mix is set at \$32.00. How much will it cost to render the monument if it labour costs will total \$300.00?

- 43.** (a) Find $z^2 - 2iz$ given that $z = 2 + i$.
 (b) If $z = 2cis\left(\frac{\pi}{3}\right)$ and $w = 3cis\left(\frac{7\pi}{12}\right)$, find
 i. $\left|\frac{z^2}{w^3}\right|$ ii. $\text{Arg}\left(\frac{z^2}{w^3}\right)$
 (c) Given that $2i$ is a zero of the polynomial $P(z) = 2z^3 + 3z^2 - az + 12$, find a .

- 44.** (a) Given that $\tan 2\alpha = 2$, $\frac{\pi}{2} < \alpha < \pi$, find the exact value of $\tan \alpha$.
- (b) Find the i. domain ii. range of $f(x) = \frac{1}{2}\text{Cos}^{-1}(1-x) + \frac{\pi}{4}$.
- (c) Find the range of the function $f(x) = 3 - \frac{1}{2}\sin 2x$, $\frac{\pi}{2} < x < \pi$.
- (d) The equation of the graph shown is given by $g(x) = a(1 - \cos kx)$.
Find the values of i. a .
ii. k .
- (e) The function $f: \left[-\frac{\pi}{3}, \frac{\pi}{3}\right] \mapsto \mathbb{R}$, where $f(x) = \tan x$ has an inverse function, f^{-1} . Determine the domain of f^{-1} and sketch f^{-1} .

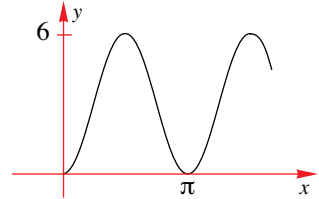

- 45.** As part of a long term research project, economists from the Department of Agriculture have been recording the price of a bale of wool and a bushel of wheat on a weekly basis. The economists started collecting the information on the 1st January 2004.

After some time they realized that the the price for each item could be reasonably approximated by mathematical functions.

The price, in dollars per bale of wool is given by $W(t) = 15 + 5 \cos\left(\frac{\pi}{25}t\right)$.

The price, in dollars per bushel of wheat is given by $P(t) = 3te^{-0.05t} + 5$.

In each case, t is the number of weeks from the 1st January 2004 (so that 1st January corresponds to $t = 0$, 8th January corresponds to $t = 1$ and so on).

- (a) Determine the price of wool and wheat on the following dates:
i. 29 January 2004 (after 4 weeks).
ii. 20th May 2004 (after 20 weeks).
iii. 2nd August 2004 (after 35 weeks).
- (b) Give the amplitude and period of the function W .
- (c) Use the following information to help you sketch the graphs of W and P .

t	5	15	25	50
$W(t)$	19.05	13.45	10	20

t	10	15	25	50
$P(t)$	23.2	26.26	26.48	17.31

- (d) What is the maximum price that the wheat reaches?
- (e) Estimate, **from the graph**, during which weeks, after the 1st January 2004, the price of wool and the price of wheat are equal.

- 46.** The owner of ‘Sandra’s Health Foods’ decides that even though there is a recession, now is the time to expand by opening another shop. To complete the expansion she intends to borrow \$50000. After discussions with her bank manager, they come to an agreement where she can borrow \$50000 at 10% compounded annually. Sandra agrees to repay the loan at a fixed rate of \$6000 per year at the end of the year (i.e., after the interest has been calculated).

- (a) Calculate the amount she owes the bank at the end of the first, second and third year.

MATHEMATICS – Higher Level (Core)

- (b) Calculate the amount she owes at the end of the tenth year.
 (c) How many years will it take her to repay the debt?

Being conscious of her financial affairs, Sandra decides that on her retirement she wishes to establish an annuity. She wants an annuity which will pay her a fixed amount of \$2000 per month at the end of each month for thirty years. She can invest with a broker at 9% p.a. compounded monthly.

- (d) How much should she invest in order to establish this annuity?

- 47.** Towers of cards can be built as follows:

The first stage has 2 cards in one layer.
 The second stage has 4 cards in the bottom layer, a card resting on top which supports another 2 cards. The third stage has 6 cards in the bottom layer, 2 cards resting on top which supports a second stage tower.

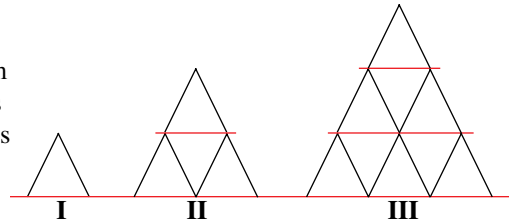

- (a) i. Draw a four stage tower.
 ii. How many cards are used in building this tower?
 (b) The following sequence represents the number of cards used to build each tower: 2, 7, 15, Find the next four terms of the sequence.
 (c) If t_n = the number of cards used to build an n -stage tower then there is a difference equation of the form $t_n = t_{n-1} + an + b$. Find a and b .
 (d) How many cards would be needed to make a ten-stage tower?
 (e) Find a formula for t_n in terms of n .
 (f) Prove by mathematical induction, your proposition in (e).

- 48.** The depth ($h(t)$ metres) of the water at a certain point on the coast, at time t hours after noon on a particular day, is given by

$$h(t) = 2.5 + \frac{1}{2} \cos \frac{4\pi}{25}(t + 2), t \geq 0$$

- (a) What is the depth of the water at noon?
 (b) What is the depth of the water at i. high tide?
 ii. low tide?
 (c) At what time on that afternoon will low tide occur?
 (d) Sketch the graph of $h(t)$ for $0 \leq t \leq 12.5$.
 (e) On that afternoon the local people are building a bicentennial bonfire on a rock shelf at the point. They estimate that they can go to and fro to work on the rock shelf only when the depth of water at the point is less than 2.25 metres. Between what times can they plan to work on the rock shelf at building the bonfire?

- 49.** A block of land has measurements as shown in the diagram. Calculate its area in hectares, correct to 3 decimal places. (1 hectare = 10000 square metres)

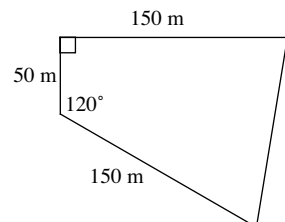

- 50.** Find $\left\{ x \mid 1 + \sqrt{3} \tan 2\left(x - \frac{\pi}{3}\right) = 0, 0 < x < \pi \right\}$

- 51.** (a) Find the values of x between $-\pi$ and π for which $2 \cos \frac{x}{2} - 1 = 0$.
- (b) Sketch the graph of $y = 2 \cos \frac{x}{2} - 1$, $-\pi \leq x \leq \pi$.
- (c) Hence find the value of x between $-\pi$ and π for which $2 \cos \frac{x}{2} - 1 > 0$.

- 52.** From an observation point A, the true bearing of a landmark C is 051° and the bearing of another landmark D is 284° . From another observation point B, 1000 metres due north of A, the bearing of C is 115° and the bearing of D is 224° . Find the distance between C and D, correct to the nearest metre.

- 53.** The temperature $A^\circ\text{C}$ inside a house at time t hours after 4:00 am is given by

$$A = 21 - 3 \cos\left(\frac{\pi t}{12}\right), 0 \leq t \leq 24$$

and the temperature $B^\circ\text{C}$ outside the house at the same time is given by

$$B = 22 - 5 \cos\left(\frac{\pi t}{12}\right), 0 \leq t \leq 24.$$

- (a) Find the temperature inside the house at 8:00 am.
- (b) Write down an expression for $D = A - B$, the difference between the inside and outside temperatures.
- (c) Sketch the graph of D for $0 \leq t \leq 24$.
- (d) Determine when the inside temperature is less than the outside temperature.
- 54.** A surveyor measures the angle of elevation of the top of a mountain from a point at sea level as 20° . She then travels 1000 metres along a road which slopes uniformly uphill towards the mountain. From this point, which is 100 metres above sea level, she measures the angle of elevation as 23° . Find the height of the mountain above sea level, correct to the nearest metre.

- 55.** The number of cancer cells in a solution is believed to increase in such a way that at the end of every hour, there are $\alpha\%$ more cells than at the end of the previous hour. Dr. Bac Teria, who is in charge of this experiment, has been recording the cell counts. Unfortunately, because of his preoccupation with another experiment he has been rather neglectful. The only available readings are shown in the table below:

t	1	2	3	4	5	6
$N(t)$			2420			3221

- (a) The number of cells, $N(t)$, in the solution at the end of every hour is thought to be modelled by a geometric progression. That is, $N(t) = N_0 \times r^{t-1}$, $t = 1, 2, \dots$
- i. Show that $r = 1 + \frac{\alpha}{100}$.
- ii. Find the values of N_0 and α .
- (b) Copy and complete the table above.
- (c) When is the first time that the number of cells in the solution exceeds 258259?
- (d) At the end of every hour a new identical solution is set up in the same way that the first one was. How many cells will there be altogether at the end of a 24 hours run of introducing a new solution at the end of every hour.

56. (a) In Figure 1., A square having side length 2 cm has a quarter of a circle drawn within it as shown in the diagram below.
Find the area of the shaded region in Figure 1.

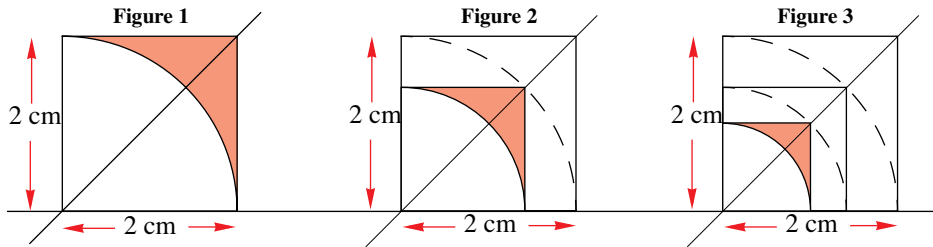

- (b) Figure 2 consists of the same diagram as Figure 1 but this time a second square is drawn so that its diagonal line coincides with that of the original square and its corner meets the quarter circle. Once again, a quarter of a circle is drawn within the smaller square as shown.
Find the area of the shaded region in Figure 2.

The process is then continued, as in Figure 3, so that the shaded areas in each of the figures, form a sequence, A_1, A_2, A_3, \dots , where A_1 is the measure of the shaded area in Figure 1, A_2 is the measure of the shaded area in Figure 2, and so on.

- (c) i. Show that the sequence A_1, A_2, A_3, \dots is in fact geometric.
ii. Find the common ratio.
iii. Write down an expression for the n th term, A_n .
iv. What would the area of 5th shaded region be if we continued drawing figures using the same method?
- (d) i. Find the sum of the first 5 shaded regions.
ii. If the process was to continue indefinitely, what would the areas of the shaded regions add to?
- (e) What type of a sequence would the arc lengths of the quarter circle form? Explain.

57. A finite triangular grid can be made of equilateral triangles. Illustrated below is a grid of order 2, named so because the least number of arcs used in a path from the node **A** to any of the nodes **1, 2** or **3** is two. **A** is a vertex of a second order triangular grid and the opposite side has a set of nodes labelled 1, 2, 3 with additional nodes **B** and **C**. **BC2** is an example of a *small triangle*.

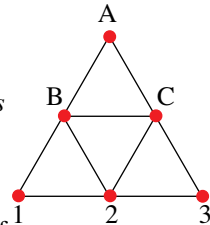

- (a) Draw a finite triangular grid of order 1 and of order 3.
(b) For a finite triangular grid of order 2 how many *small triangles* are there?
(c) For a finite triangular grid of order 3, 4 and 5 how many *small triangles* are there?
(d) How many *small triangles* are there in a finite triangular grid of order n ?
(e) How many **nodes** are there for a triangular grid of order 1, 2, 3 and 4?
(f) The number of **nodes** for an n th order triangular grid is given by $\frac{1}{2}(an^2 + bn + c)$.
Determine the values of a, b and c .
(g) Use mathematical induction to prove the proposition in (f).
(h) As n tends to infinity, what does the ratio of the number of **nodes** to the number of *small triangles* tend to? Comment on this result.

13.1 DESCRIBING DATA

13.1.1 DATA COLLECTION

Statistics is the science of getting ‘facts from figures’ and involves the collection, organisation and **analysis** of sets of observations called **data**. The data represents individual observations to which we can assign some numerical value or categorise in some way that identifies an **attribute**.

The set from which the data is collected is known as the **population**. The population can be finite or infinite, however, the data collected will be a subset from this population. Such a subset is called a **sample**. The process of gathering the data is known as **sampling**. Once we have our sample, we use characteristics of the sample to draw conclusions about the population. This is known as making **statistical inferences**. Note that statistical inference is quite different from simply collecting data and then displaying or summarising it as a ‘diagram’ – which is known as **descriptive statistics**.

The method that is used in collecting the sample affects the validity of the inferences that can or should be made. The aim then is to obtain a sample that is representative of the population.

This concept can be represented as follows:

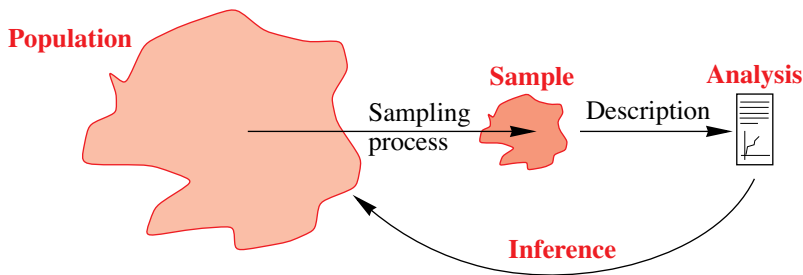

One approach to reduce bias in the sample we acquire is to use a **random sampling process**. By doing this we stand a better chance of obtaining samples that reflect the population as a whole.

13.1.2 TYPES OF DATA

Data can be classified as numerical or categorical –

1. **Numerical data:** These are made up of observations that are quantitative and so have a numerical value associated with them.
For example, if the data is to represent heights, then the data would be collected as numerical values, e.g., 172 cm, 165 cm, etc.
2. **Categorical data:** These are made up of observations that are qualitative (which are sometimes also known as nominal data).
For example, if the data is to represent hair colour, then the data would be collected as qualitative data e.g., black, brown, blue, etc.

13.1.3 DISCRETE AND CONTINUOUS DATA

As a rule of thumb, **discrete data** are sets of data that can be **counted**, which distinguishes it from **continuous data** that are sets of data that are **measured**.

EXERCISES 13.1

1. Micro Inc. produces 14,500 electrical components each month. Of these, 2000 are randomly selected and tested.
The test reveals 42 defective components.
 - (a) What is
 - i. the population size.
 - ii. the sample size.
 - (b) Give an estimate of the number of defectives produced during that month.

2. A salmon farm is attempting to determine the number of salmon in its reservoir. On Monday 300 salmon were caught, tagged and then released back into the reservoir. The following Monday 200 salmon were caught and of these 12 were tagged.
 - (a) Comment on the sampling procedure. Is the sample size large enough? Is there a bias involved?
 - (b) Estimate the the number of salmon in the reservoir.

3. A manufacturer wishes to investigate the quality of his product – a measuring instrument that is calibrated to within a 0.01 mm reading accuracy. The manufacturer randomly selects 120 of these instruments during one production cycle. She finds that 8 of the instruments are outside the accepted measuring range. One production cycle produces 1500 of these measuring instruments.
 - (a) What is
 - i. the population size.
 - ii. the sample size.
 - (b) Give an estimate of the number of unacceptable instruments produced during a complete production cycle.
 - (c) In any given week there are 10 production cycles. How many unacceptable instruments can the manufacturer expect at the end of a week. Comment on your result.

4. Classify the following as categorical or numerical data.
 - (a) The winning margin in a soccer game.
 - (b) The eye colour of a person.
 - (c) The number of diagrams in a magazine.
 - (d) The breed of a cat.
 - (e) The fire-hazard levels during summer.

5. Classify the following as discrete or continuous data.
 - (a) The number of cats in a town.
 - (b) The length of a piece of string.
 - (c) The time to run 100 metres.
 - (d) The number of flaws in a piece of glass.
 - (e) The volume of water in a one litre bottle.

13.2 FREQUENCY DIAGRAMS

13.2.1 PRODUCING A FREQUENCY DIAGRAM

The following figures are the heights (in centimetres) of a group of students:

156 172 168 153 170 160 170 156 160 160 172 174
 150 160 163 152 157 158 162 154 159 163 157 160
 153 154 152 155 150 150 152 152 154 151 151 154

These figures alone do not give us much information about the heights of this group of people. One of the first things that is usually done in undertaking an analysis is to make a frequency table. In this case as there are a large number of different heights, it is a good idea to group the height data into the categories (or classes) 148-150, 151-153, 154-156, etc. before making a tally.

Heights	Tally	Frequency
148-150	√√√	3
151-153	√√√√√√√√	8
154-156	√√√√√√√	7
157-159	√√√√	4
160-162	√√√√√√	6
163-165	√√	2
166-168	√	1
169-171	√√	2
172-174	√√√	3

Each height is recorded in the appropriate row of the tally column. Finally, the frequency is the number of tally marks in each row. As a check, the total of the frequency column should equal the count of the number of data items. In this case there are 36 heights.

The choice of class interval in making such a frequency table is generally made so that there are about ten classes. This is not inevitably the case and it is true to say that this choice is an art rather than a science. The objective is to show the distribution of the data as clearly as possible. This can best be seen when the data is shown graphically. There are a number of ways in which this can be done. In the present example, we are dealing with heights. Since heights vary continuously, we would most usually use a histogram to display the distribution.

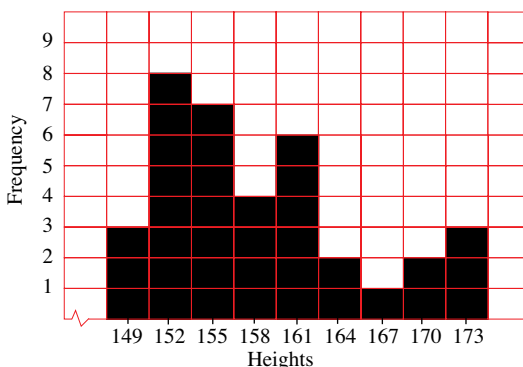

MATHEMATICS – Higher Level (Core)

There are two details connected with the construction of histograms that you should not ignore. Firstly, as far as the horizontal scales are concerned, we are representing the continuous variable ‘height’. The first class interval represents all the people with heights in the range 148 to 150cm. Since these have been rounded to the nearest whole centimetre, anyone with a height from 147.5 to 150.5cm, or $[147.5, 150.5)$, will have been placed in this class. Similarly, anyone with a height in the range $[150.5, 153.5)$ will be categorised in the class 151-153cm. If you want to label the divisions between the blocks on the histogram, technically these should be 147.5, 150.5 etc. Secondly, in a histogram, it is the area of the bars and not their height that represents the number of data items in each class. To be completely correct, we should give the area as a measure of the vertical scale. This definition allows us to draw histograms with class intervals of varying widths. This is sometimes done to smooth out the variations at the extremes of a distribution where the data is sparse. This aspect will not be considered in this chapter.

Once we have drawn a histogram, it should be possible to see any patterns that exist in the data. In this case, there is a big group of students with heights from about 150 to 160cm. There are also quite a few students with heights significantly larger than this and very few with heights below the main group. The distribution has a much larger ‘tail’ at the positive end than at the negative end and is said to be positively skewed. Such patterns can also be seen using other graphical devices. Such as a line graph:

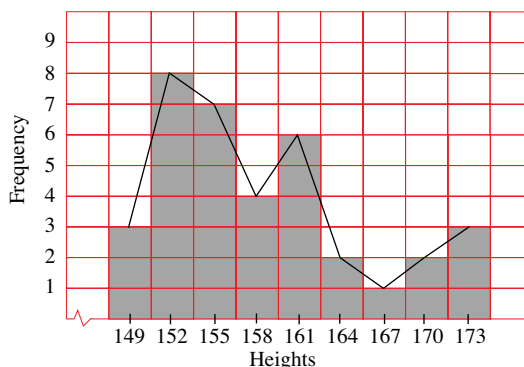

The same patterns are evident from this diagram as were seen from the histogram.

13.2.2 USING A GRAPHICS CALCULATOR

Data can be entered on the calculator either as separate figures from the original data or as a frequency table. In both cases, the data is entered as a list.

To enter the original data, press the **STAT** key and choose **EDIT** from the screen menus. If necessary, press 4 followed by the keys **L1** (2nd 1), **L2** (2nd 2) etc. **ENTER** to clear any previous lists. Next select **STAT EDIT**. The data can now be entered as a column under **L1**.

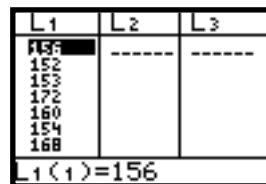

The data can now be displayed as a statistical graph. As with other types of graph, the appropriate window must be set. In the present case, the x data range should be set at 145 to 175. The **Xscl** setting determines the width of class interval that will be used.

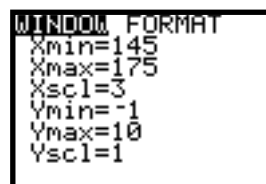

Next, any Cartesian graphs must be cleared. Press **Y=** and clear any rule that you see. The statistical plotting facility must now be activated. Press **2nd STAT PLOT**. Choose plot 1 and turn it on by using the arrows to the word **On** and then press **ENTER**. Also select the histogram symbol from the list of available plot types. We entered the data as **L1** so we must select this as the source of the data. Finally,



because each height was entered separately, the frequency must be defined as 1. Pressing **GRAPH** should now display the histogram. This should be similar to that produced earlier.

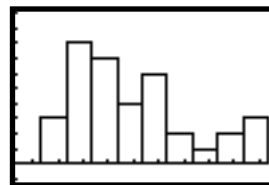

One advantage of using a calculator to produce such plots is that, once the data has been stored, the conditions of the plot can be varied rapidly. For example, if the **Xscl** is changed to 1, the class interval of the frequency table becomes 1 and the histogram is as shown.

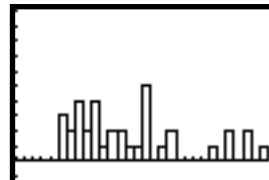

If the data is presented as a grouped list (frequency table), the x values should be entered as **L1** and the frequencies as **L2**. In the case of the height data, the mid-point of each class interval (149, 152, 155 etc.) should be entered in **L1**. The **STAT PLOT** instructions must also be set to record the fact that the frequencies are stored in **L2** before statistical plots or calculations will be successful.

L1	L2	L3
149	3	
152	8	
155	7	
158	4	
161	6	
164	2	
167	1	

L2 = {3, 8, 7, 4, 6, 2, ...}

EXERCISES 13.2

1. The following figures are the weights (in grams) of a group of fish sampled from a reservoir:

226	233	233	244	224	235	238	244
222	239	233	243	221	230	237	240
225	230	236	242	222	235	237	240
220	235	238	243	222	232	232	242
229	231	234	241	228	237	237	245
229	231	237	244	225	236	235	240

- (a) Construct a frequency table using the following class intervals:
218-220, 221-223, 224-226 etc. grams.
(b) Draw a histogram showing this distribution.

2. In a study of the weights of a sample of semi-precious gem-stones, the following results were obtained (grams):

1.33	1.59	1.82	1.92	1.46	1.57	1.82	2.06
1.59	1.70	1.81	2.02	1.24	1.53	1.69	2.01
1.57	1.62	1.61	1.93	1.11	1.90	1.79	1.91
1.19	1.53	1.90	1.90	1.17	1.97	1.92	2.06
1.41	1.64	1.83	1.90	1.11	1.81	1.83	1.90
1.15	1.68	1.82	1.98	1.39	1.54	1.92	2.04

- (a) Construct a frequency table using the following class intervals:
[1.1,1.2), [1.2,1.3), [1.3,1.4) etc. grams.
(b) Draw a histogram showing this distribution.

- 3.** Make a frequency table and draw a histogram for the following sets of data.

Set A:

21.1	28	26.9	31.9	23.7	28.8	27.9	31.3
21.5	26.8	27.4	31.2	21.4	29.9	29.4	31.5
20.4	25.1	25.8	33.6	23.7	25.6	29.1	30.3
21.5	28.2	28.2	31.3	22.4	25.7	25.1	30.3
21.9	29.1	28.7	30.1	21.8	27.8	29.1	34.3
22.5	25.2	25.5	32.9	22.3	29	27.2	33.3

Set B

7	6	5	70	9	9	25	72
7	7	4	72	8	9	28	73
9	9	9	72	6	7	27	71
7	7	9	70	6	8	27	73
8	5	26	73	5	6	26	70
9	9	28	73	5	8	26	71

Compare the two data sets.

13.3 STATISTICAL MEASURES 1

13.3.1 MEASURE OF CENTRAL TENDENCY

After using a graphical presentation of some sort to look at the general pattern of the data, we would usually calculate some representative ‘statistics’. The aim of producing these is to reduce the amount of data to a small number of figures that represent the data as well as possible. In the case of the height data we have been studying, we have already observed that the heights group around the range 150-160 cm. This is sometimes known as a ‘central tendency’ and we have several ways in which we measure this:

13.3.2 MODE

This is the most frequent class of data. In the present case there were more students in the 151-153 cm class than any other so we would give this class as the mode. It is possible for some data to have more than one mode. We describe this as being bimodal, trimodal etc. The mode tends only to be used when there is no alternative such as when we are collecting data on the television stations that people like best.

13.3.3 MEAN

This is the measure commonly (and incorrectly) called average. Numeric data is added and the result is divided by the number of items of data that we have.

Notation: The notation used for the mean depends on whether or not we are claiming to have the mean of all (the **population**) or part (a **sample**) of the possible data set.

In the case of the students, we appear to have a small group of 36 selected from all the possible students in this age group and so we are looking at a sample. It is generally quite clear whether any set of data refers to a population (such as a **census**) or a sample (such as a **poll**).

The **population mean** is denoted by μ and a **sample mean** by \bar{x} .

For a data set x , with n items both means are calculated in the same way:

$$\text{Mean} = \frac{\sum x}{n} = \frac{1}{n} \sum x$$

The symbol Σ means ‘add all the following’.

If the data is presented in the form of a frequency table in which each item of data x_i is present with a frequency of f_i , then the formula becomes:

$$\text{Mean} = \frac{\sum f_i x_i}{\sum f_i}$$

For the height data, we have two ways of approaching this calculation. One way is to return to the original data and add it all up.

The total is 5694. There are 36 measurements so: $\text{Mean} = \frac{5694}{36} = 158.16667$

Alternatively we can use the grouped data formula. There is a convenient way of doing this if we add an extra column to the original frequency table:

Heights	Mid-height	Frequency	$f \times h$
148-150	149	3	447
151-153	152	8	1216
154-156	155	7	1085
157-159	158	4	632
160-162	161	6	966
163-165	164	2	328
166-168	167	1	167
169-171	170	2	340
172-174	173	3	519
Totals:		36	5700

From the table:

$$\sum f_i = 36 \text{ and } \sum f_i \times h_i = 5700 \text{ so Mean} = \frac{\sum f_i \times h_i}{\sum f_i} = \frac{5700}{36} = 158.33333 .$$

This method of calculating the mean will not necessarily give exactly the same answer as the mean calculated from the original data as we have made the assumption that all the students with heights in the range 148-150 cm had a height of 149 cm. This will not generally be a seriously inaccurate assumption as the students with heights below this figure (148 cm) will be balanced by those with heights above this (150 cm). In this case, the difference is quite small.

13.3.4 MEDIAN

The median is found by arranging all the data in order of size and selecting the middle item. For the heights data, there is an even number of figures and so there is not a middle number. In this situation, we take the mean of the middle two data items.

Order	1	2	3	4	5	6	7	8	9
Ht:	150	150	150	151	151	152	152	152	152
	10	11	12	13	14	15	16	17	18
	153	153	154	154	154	154	155	156	156
	19	20	21	22	23	24	25	26	27
	157	157	158	159	160	160	160	160	160
	28	29	30	31	32	33	34	35	36
	162	163	163	168	170	170	172	172	174

The middle heights are the 18th and 19th (156 and 157cm) so the median is 156.5cm.

It is usual to take the mean of the two numbers to give an answer to represent the median, however, there are a number of interpolations that can be used. For our purposes however, we will continue to use the mean of the two observations.

When there are $2n + 1$ observation, i.e., there is an odd number of observations, the median corresponds to the $\frac{(2n + 1) + 1}{2}$ th observation (after they have been placed in order from lowest to highest).

e.g For the data set $\{2, 4, 12, 7, 9\}$ we first list the data from lowest to largest: 2, 4, 7, 9, 12.

Here $n = 5$ and so the middle observation is the $\frac{5 + 1}{2} = 3$ rd observation. i.e., 7.

EXERCISES 13.3

- For the data set of Exercise 13.2 Q.1., find the mode, mean and median weights.
- For the data set of Exercise 13.2 Q.2., find the mode, mean and median weights.
- For the data sets of Exercise 13.2 Q.3., find the mode, mean and median weights.
- The following numbers represent the annual salaries of the employees of a small company.

\$20910	\$20110	\$20390	\$20170	\$20060	\$20350
\$21410	\$21130	\$21340	\$21360	\$21360	\$21410
\$20350	\$20990	\$20690	\$20760	\$20880	\$20960
\$21240	\$21060	\$21190	\$21400	\$76000	\$125000

 - Find the mean salary.
 - Find the median salary.
 - Which of the two figures is the better representative measure of salary?

5. The selling prices for the properties in a suburb over June 2004 were:

\$191000	\$152000	\$152000	\$181000
\$180000	\$163000	\$169000	\$189000
\$184000	\$169000	\$167000	\$172000
\$190000	\$169000	\$159000	\$172000
\$202000	\$162000	\$160000	\$154000
\$181000	\$166000	\$163000	\$196000
\$201000	\$154000	\$166000	\$154000
\$178000	\$164000	\$157000	\$185000
\$177000	\$169000	\$157000	\$172000
\$195000	\$150000	\$163000	\$1150000
\$186000	\$166000	\$151000	\$1155000
\$185000	\$151000	\$168000	\$1200000

- (a) Find the mean selling price.
- (b) Find the median selling price.
- (c) Which of the two figures is the better representative measure of selling price?

6. For the figures given below, calculate the mean from the original data.

5	16	15	17	9	16	19	15
6	17	10	16	8	13	13	19
7	16	18	18	8	18	19	18
6	17	19	16	7	13	17	19
9	14	17	19	9	16	17	19
8	18	16	15	8	18	16	15

- (a) Use the frequency table method with class intervals 4-6, 7-9 etc. to calculate the mean of the data.
- (b) Use the frequency table method with class intervals 1-5, 6-10 etc. to calculate the mean of the data.

13.4 STATISTICAL MEASURES 2

13.4.1 MEASURES OF SPREAD

So far we have only looked at ways of measuring the central tendency of a set of data. This is not necessarily the only feature of a data set that may be important. The following sets of data are test results obtained by a group of students in two tests in which the maximum mark was 20.

Test 1.

4	12	11	10	5	10	12	12	6	8	19	13	3
7	11	13	4	9	12	10	6	13	19	11	3	12
14	11	6	13	16	11	5	10	12	13	7	8	13
14	6	10	12	10	7	10	12	10				

Test 2.

9	8	10	10	8	9	10	11	8	8	11	10	9
8	11	10	9	8	10	11	8	9	11	10	9	8
11	11	9	9	11	10	8	9	11	10	8	9	11
11	8	8	11	10	8	9	10	10				

The means of the two data sets are fairly close to one another (Test 1, 10.1, Test 2, 9.5). However,

MATHEMATICS – Higher Level (Core)

there is a substantial difference between the two sets which can be seen from the frequency tables.

Test 1

Mark	3	4	5	6	7	8	9	10	11	12	13	14	15	16	17	18	19
Freq.	2	2	2	4	3	2	1	8	5	8	6	2	0	1	0	0	2

Test 2

Mark	3	4	5	6	7	8	9	10	11	12	13	14	15	16	17	18	19
Freq.	0	0	0	0	0	13	11	12	12	0	0	0	0	0	0	0	0

The marks for Test 1 are quite well spread out across the available scores whereas those for Test 2 are concentrated around 9, 10 & 11. This may be important as the usual reason for setting tests is to rank the students in order of their performance. Test 2 is less effective at this than Test 1 because the marks have a very small spread. In fact, when teachers and examiners set a test, they are more interested in getting a good spread of marks than they are in getting a particular value for the mean. By contrast, manufacturers of precision engineering products want a small spread on the dimensions of the articles that they make. Either way, it is necessary to have a way of calculating a numerical measure of the spread of data. The most commonly used measures are variance, standard deviation and interquartile range.

13.4.2 VARIANCE AND STANDARD DEVIATION

To calculate the variance of a set of data, the frequency table can be extended as follows:

Test 1

Mark (M)	Frequency	$M - \mu$	$f(M - \mu)^2$
3	2	-7.10	100.82
4	2	-6.10	74.42
5	2	-5.10	52.02
6	4	-4.10	67.24
7	3	-3.10	28.83
8	2	-2.10	8.82
9	1	-1.10	1.21
10	8	-0.10	0.08
11	5	0.90	4.05
12	8	1.90	28.88
13	6	2.90	50.46
14	2	3.90	30.42
15	0	4.90	0.00
16	1	5.90	34.81
17	0	6.90	0.00
18	0	7.90	0.00
19	2	8.90	158.42
Total:			640.48

The third column in this table measures the amount that each mark **deviates from the mean** mark

of 10.10. Because some of these marks are larger than the mean and some are smaller, some of these deviations are positive and some are negative. If we try to calculate an average deviation using these results, the negative deviations will cancel out the positive deviations. To correct this problem, one method is to square the deviations. Finally, this result is multiplied by the frequency to produce the results in the fourth column.

The last row is calculated: $2 \times (3 - 10.10)^2 = 2 \times 50.41 = 100.82$.

The total of the fourth column is divided by the number of data items (48) to obtain the variance of the marks: $\text{Variance} = \frac{640.48}{48} = 13.34$

The measure most commonly used is the square root of the variance (remember that we squared the deviations). A measure that is known as the **standard deviation** of the marks. In the previous case: $\text{Standard deviation} = \sqrt{13.34} = 3.65$

Repeating this calculation for the second set of marks:

Mark (M)	Frequency	$M - m$	$f(M - m)^2$
8	13	-1.48	28.475
9	11	-0.48	2.534
10	12	0.52	3.245
11	12	1.52	27.725
Total:			61.979

$$\text{Variance} = \frac{61.979}{48} = 1.291$$

$$\text{Standard deviation} = \sqrt{1.291} = 1.136$$

This figure is about one third of the figure calculated for Test 1. This reflects the fact that Test 2 has not spread the students very well.

In summary, the variance and population standard deviation are calculated using the formulas:

$$\text{Variance} = \frac{\sum f_i(x_i - \mu)^2}{\sum f_i} \quad \text{Population Standard Deviation} = \sqrt{\frac{\sum f_i(x_i - \mu)^2}{\sum f_i}}$$

Of course, all of this type of mechanical work is very tedious, and seldom is it the case that we are required to work our way through these calculations. Statisticians (or anyone required to produce statistics such as these) would generally use a statistical package of some sort, where data could be easily transferred and then manipulated by any number of different commands. However, it is not necessary to have access to high powered statistical packages. Spreadsheets are widely used to produce the same results.

In many areas of this course we have seen (and will continue to see) how powerful the graphics calculator is. In the area of statistics, the TI-83 comes into its own. Once the data is entered as a list, it becomes a very powerful tool. And so, as we have said many a time before, make sure that you become familiar with all that your graphics calculator has to offer.

13.4.3 USING A GRAPHICS CALCULATOR

Standard deviation can be calculated directly by first entering the data as a list.

For Test 2, this is best done with the marks as list 1 and the frequencies as list 2.

Next, use **STAT CALC** to access the **1-VarStats** menu. Next, you must nominate the two lists that contain the data. List 1 is **2nd 1** and list 2 is **2nd 2**. The two list names must be separated by a comma.

Finally, press **ENTER**. This screen gives the mean, (\bar{x}) , the sum of the data, Σx , and the sum of the squares of the data, Σx^2 .

Sx is known as the **sample standard deviation**. This is the same as the standard deviation discussed above but with one less than the number of data items in the denominator (47 in this case).

σx is the **population standard deviation** discussed above.

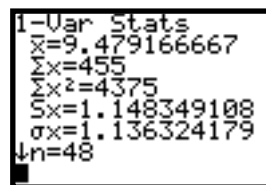
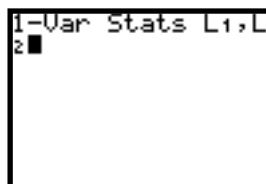
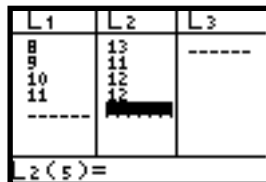

Sample standard deviation? Population standard deviation? What's it all about? Unfortunately there are regional variations (as well as in textbooks) in the notation and the language that is used to define these terms.

When we refer to the **sample variance**, it suggests that we are finding the variance of a sample and by default, the sample is a subset of a population and so we are in fact finding an estimate of the population variance. This estimate is known as the **unbiased estimate** of the population variance.

The **unbiased estimate** of the population variance, σ^2 , is given by $s_{n-1}^2 = \frac{1}{n-1} \sum_{i=1}^n f_i(x_i - \bar{x})^2$.

The standard deviation of the sample is given by the square root of s_{n-1}^2 , i.e., $\sqrt{s_{n-1}^2}$, which corresponds to the value **Sx** that is produced by the TI-83.

The **variance of a population**, σ^2 , is given by $\sigma^2 = \frac{1}{n} \sum_{i=1}^n f_i(x_i - \bar{x})^2$. The standard deviation

then is $\sigma = \sqrt{\sigma^2}$.

To differentiate between division by n and division by $n - 1$ we use s_n^2 for division by n and s_{n-1}^2 for division by $n - 1$. Giving the relationship $s_{n-1}^2 = \frac{n}{n-1} s_n^2$.

Then, as the population variance, σ^2 , is generally unknown, s_{n-1}^2 serves as an **estimate** of σ^2 .

On the TI-83 we have that **Sx** = s_{n-1} and **σx** = s_n .

It is therefore important that you are familiar with the notation that your calculator uses for sample standard deviation (unbiased) and population standard deviation.

EXERCISES 13.4

1. The weights (kg) of two samples of bagged sugar taken from a production line

Sample from machine A

1.95 1.94 2.02 1.94 2.07 1.95 2.02 2.06
 2.09 2.09 1.94 2.01 2.07 2.05 2.04 1.91
 1.91 2.02 1.92 1.99 1.98 2.09 2.05 2.05
 1.99 1.97 1.97 1.95 1.93 2.03 2.02 1.90
 1.93 1.91 2.00 2.03 1.94 2.00 2.02 2.02
 2.03 1.96 2.04 1.92 1.95 1.97 1.97 2.07

Sample from machine B

1.77 2.07 1.97 2.22 1.60 1.96 1.95 2.23
 1.79 1.98 2.07 2.32 1.66 1.96 2.05 2.32
 1.80 1.96 2.06 1.80 1.93 1.91 1.93 2.25
 1.63 1.97 2.08 2.32 1.94 1.93 1.94 2.22
 1.76 2.06 1.91 2.39 1.98 2.06 2.02 2.23
 1.75 1.95 1.96 1.80 1.95 2.09 2.08 2.29

- (a) Find the mean weights of the bags in each sample.
- (b) Use the formula $S_x = \sqrt{\frac{\sum f_i(x_i - \bar{x})^2}{\sum f_i - 1}}$ to calculate the sample standard deviations of each sample.
- (c) Use the formula $\sigma_x = \sqrt{\frac{\sum f_i(x_i - \mu)^2}{\sum f_i}}$ to calculate the population standard deviations of each sample.

2. The following frequency table gives the numbers of passengers using a bus service over a week long period.

Passengers	0-4	5-9	10-14	15-19	20-24	25-29
Frequency	3	5	11	15	10	7

- (a) Find the mean number of passengers carried per trip.
- (b) Find the population standard deviation of the number of passengers carried per trip.

3. The number of matches per box in a sample of boxes taken from a packing machine was:

Matches	47	48	49	50	51	52
Frequency	3	6	11	19	12	9

Find the mean and sample standard deviation of the number of matches per box.

13.5 STATISTICAL MEASURES 3

13.5.1 QUARTILES

We have already seen that there is more than one way of measuring central tendency and the same is true of measures of spread. The median is, in some circumstances, a good measure of central tendency. Following on from this, we can define quartiles, the data items that are one quarter and three quarters of the way through a list.

The following data represent the number of employees absent from work over a nine day period:

2, 6, 5, 4, 7, 1, 0, 5, 2.

Firstly, we order the data to get 0, 1, 2, 2, 4, 5, 5, 6, 7.

The median is the middle figure:

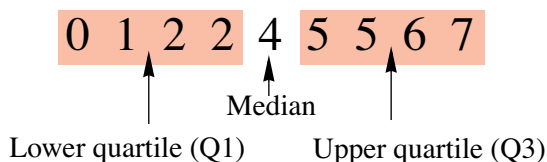

The median divides the distribution into an upper and lower group. The lower quartile is the middle figure of the lower group and the upper quartile is the middle figure of the upper group. As with finding the median, it may be necessary when dealing with a group with an even number of data items to take the mid point between two numbers. This is the case with the current data set. The lower quartile is 1.5 and the upper quartile is 5.5.

When dealing with large data sets or grouped data, there is an alternative method of finding the median and quartiles based on **cumulative frequency**.

This is calculated as follows:

These figures represent the numbers of customers in a small cinema:

Customers	Frequency	Cumulative Frequency
0-9	1	1
10-19	4	5
20-29	9	14
30-39	11	25
40-49	32	57
50-59	23	80
60-69	10	90
70-79	9	99
80-89	1	100

The cumulative frequency is calculated by ‘accumulating’ the frequencies as we move down the table. Thus the figure 25 in the shaded box means that on 25 occasions there were fewer than 40 customers.

Cumulative frequencies can now be used to produce a **cumulative frequency curve**:

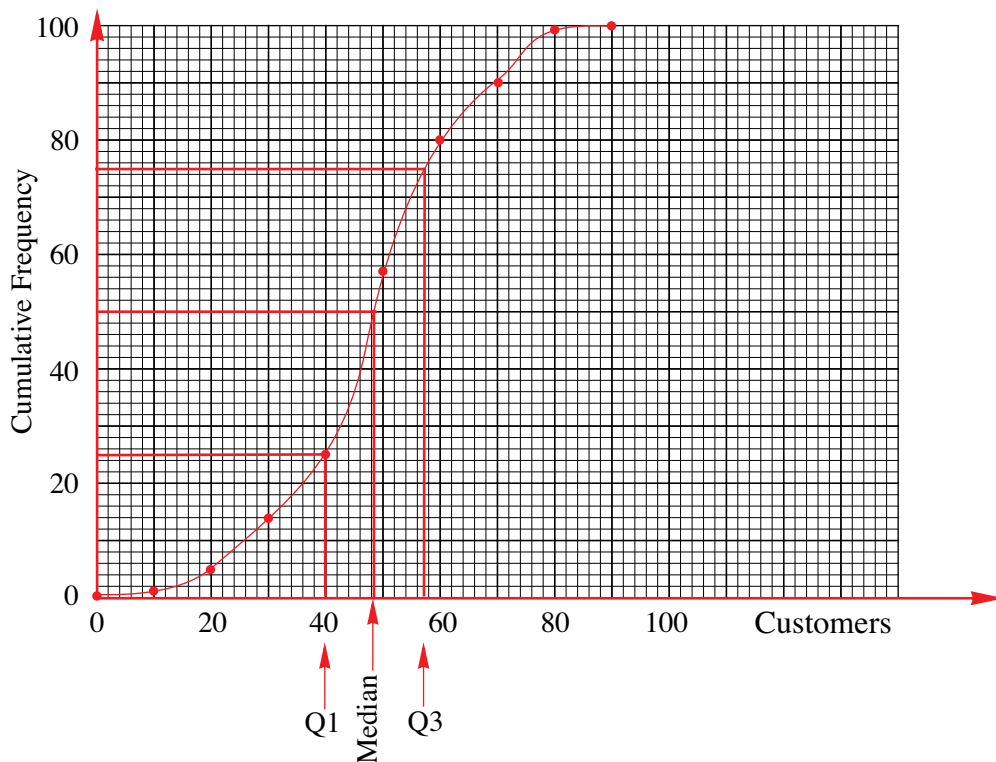

The cumulative frequency curve or **ogive** has effectively placed the data in order. This now enables us to read off estimates of the median and quartiles. The median is half way along the list of data. Since there are 100 figures, the median point is at 50. Technically this should be figure number 51, however, this method only produces an approximate figure and we seldom worry about this distinction. Reading across from 50 and down to the 'customers' scale gives a figure of about 48 customers as the median. Similarly, the lower quartile can be found at a cumulative frequency of 25. Reading across from this figure to the graph and then to the horizontal axis gives a lower quartile of approximately 40 customers. Similarly, the upper quartile is about 57 customers.

The difference between the two quartiles is known as the **inter-quartile range**. In this case, the inter-quartile range is $57 - 40 = 17$ customers. This is, like the standard deviation, a measure of the spread of the data. For these cinema attendance figures, the standard deviation is about 16 customers. It is not necessarily the case that these two measures of spread give similar answers. When comparing two data sets, choose which measure of spread you wish to use and use that measure throughout the analysis. Do not try to compare the inter-quartile range of one data set with the standard deviation of another.

In choosing which measure of spread to use, we generally use the quartiles and the median for a data set that contains a very few numbers that are very unusual. Such data are known as **outliers**. The data sets in Exercise 13.3 Questions 4 & 5 are examples of this type of data containing outliers. The standard deviation and mean are much more sensitive to outliers than are the median and inter-quartile range. Of course, you will need to look at a data set that has outliers and decide whether or not you want to minimise their effect on the representative statistics that you calculate.

13.5.2 BOX PLOT

Using a graphics calculator

The median and inter-quartile range of a data set can be found directly using a graphics calculator. The data can either be entered as a list or as a frequency table using two lists.

The data set: 5.7, 4.2, 7.9, 3.1, 9.4, 4.2, 7.7 & 8.0 can be entered as a single list.

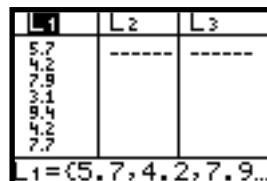

The statistics of this set can be calculated in the same way as the mean and standard deviation were calculated previously. The appropriate figures are found on the second screen (use the down arrow). This screen gives the **five figure summary** of the data:

Minimum = 3.1, lower quartile = 4.2, median = 6.7, upper quartile = 7.95 and maximum = 9.4.

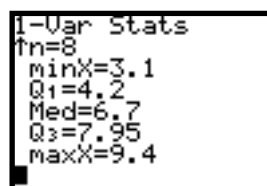

The five figure summary can be displayed using a graph known as a box-plot. This can be displayed on the TI-83 by choosing **2nd STAT PLOT**, turning on plot 1 and selecting the box-plot icon. An appropriate viewing window will also need to be set. The **TRACE** function can be used to identify the five figure summary. The diagram shows the median.

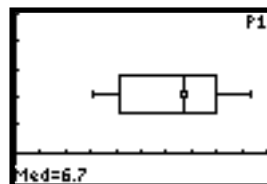

NB: The **first box-plot icon** produces a box plot showing any **outliers**.

The **second box-plot icon** produces a box plot with the **whiskers** running to the outliers.

To construct a **box-plot** (also known as a **box and whisker plot**), draw an appropriate horizontal scale. For this data set, a horizontal scale of 1 to 10 with marks every unit is appropriate. The box plot can now be drawn:

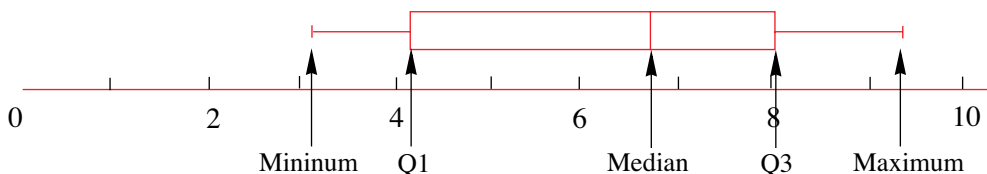

In the same way, the five figure summary for grouped data can be found by entering the data as list 1 and the frequencies as list 2. This frequency table gives the numbers of goals scored in 20 soccer matches:

Goals	0	1	2	3	4	5
Frequency	3	5	5	4	2	1

Enter the goals as **L1** and the frequencies as **L2**.

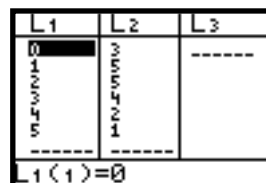

Next use the **STAT CALC** menu and identify the two lists that contain the data.

```
1-Var Stats L1,L
2
```

Press enter and use the down arrow to access the median part of the display.

```
1-Var Stats
n=20
minX=0
Q1=1
Med=2
Q3=3
maxX=5
```

EXERCISES 13.5

1. Find the median, quartiles and inter-quartile range of these data sets:

- (a) 5, 6, 2, 8, 9, 2, 7, 0, 5, 3
- (b) 2.8, 4.9, 2.8, 0.9, 3.3, 5.8, 2.9, 3.7, 6.9, 3.3, 5.1
- (c) 142, 167, 143, 126, 182, 199, 172, 164, 144, 163, 192, 101, 183, 153
- (d) 0.02, 0.25, 1.72, 0.93, 0.99, 1.62, 0.67, 1.42, 1.75, 0.04, 1.12, 1.93
- (e) 1200, 2046, 5035, 4512, 7242, 6252, 5252, 8352, 6242, 1232

2. Find the median, quartiles and inter-quartile range of these grouped data sets:

(a)

x	0	1	2	3	4	5
Frequency	1	3	6	6	7	1

(b)

x	10	11	12	13	14	15
Frequency	12	45	56	78	42	16

(c)

x	1.0	1.5	2.0	2.5	3.0	3.5
Frequency	2	4	9	9	2	1

(d)

x	10	20	30	40	50	60
Frequency	4	8	15	19	20	5

(e)

x	0	5	10	15	20	25
Frequency	0	3	0	6	7	5

MATHEMATICS – Higher Level (Core)

- 3.** The weekly expenses paid to a group of employees of a small company were

\$25	\$0	\$10	\$10
\$55	\$0	\$12	\$375
\$75	\$445	\$7	\$2

- (a) Find the mean weekly expense.
- (b) Find the population standard deviation of the expenses.
- (c) Find the median weekly expense.
- (d) Find the quartiles and the inter-quartile range of the expenses.
- (e) Which of these statistics are the best representatives of the expenses data?
- 4.** The table shows the numbers of cars per week sold by a dealership over a year.

Cars sold	0	1	2	3	4	5
Number of weeks	2	13	15	12	7	3

- (a) Find the mean weekly sales.
- (b) Find the population standard deviation of the sales.
- (c) Find the median weekly sales.
- (d) Find the quartiles and the inter-quartile range of the sales.
- 5.** The table shows the weekly turnover of a small shop over a period during Spring and Summer.

Sales (\$)	\$0-\$99	\$100-\$199	\$200-\$299	\$300-\$399
Number of weeks	2	9	15	7

- (a) Find the mean weekly sales.
- (b) Find the population standard deviation of the sales.
- (c) Construct a cumulative frequency table and draw the cumulative frequency curve.
- (d) Find the median weekly sales from your graph.
- (e) Find the quartiles and the inter-quartile range of the sales from your graph.
- 6.** Plot the cumulative frequency curves for these data and hence estimate the median, quartiles and inter-quartile range of the data.

x	0-4	5-9	10-14	15-19	20-24	25-29
Frequency	2	5	11	9	7	2

EXERCISES 13.6

– MISCELLANEOUS EXERCISES

1. Identify the sample and the population in each of these situations.
 - (a) The University of Arkansas tests a new AIDS drug on 100 randomly chosen patients suffering from the disease. After a year of treatment, 42 patients had shown positive signs of recovery and 10 patients had died. The remainder appeared unchanged by the treatment.
 - (b) The Australian Government surveys 1000 working aged people in NSW to determine unemployment figures in that state.
 - (c) John asks all members of his IB higher maths class what theme they would like for the Nappa Valley High School senior dance.

2. Classify each of the following as discrete or continuous variables:
 - (a) The grade received by a student.
 - (b) The number of people in a passing car.
 - (c) The playing time of a movie.
 - (d) Cups of coffee drunk by your maths teacher in a day.
 - (e) Rainfall in Bali in a month.
 - (f) The length of a king cobra.
 - (g) The mass of silica in a sample of 1 kg of earth.

3. Two tetrahedral dice are rolled 60 times, and the sum of their scores recorded:

2, 3, 4, 5, 6, 7, 8, 4, 4, 6, 3, 5, 5, 6, 5, 8, 5, 5, 4, 4, 2, 7, 6, 4, 5, 5, 3, 8, 7, 5, 5, 4, 4, 3, 7, 6, 6, 5, 5, 5, 6, 4, 5, 6, 3, 4, 5, 6, 3, 4, 5, 6, 2, 3, 4, 5, 6, 7, 8, 7

 - (a) Construct a frequency table from this data and draw the histogram.
 - (b) Complete the cumulative frequency distribution and draw a cumulative frequency graph

4. Choose suitable classes to group the data in each of these situations:
 - (a) About 15 classes are to be used to group 300 scores which range from 207 to 592.
 - (b) About 18 classes are to be used to group 900 scores which range from 112 to 418.
 - (c) SAT scores from 500 students are to be grouped. The lowest score is 458 and the highest score is 784. Use approximately 15 classes.

5. The weights of 50 year 9 students are measured to the nearest kg and recorded. Construct a frequency table using class intervals of 5kg and draw the histogram. Complete the cumulative frequency distribution and draw a cumulative frequency graph.

41	54	37	55	52	60	45	56	56	47
54	51	64	53	64	57	65	40	73	53
57	46	76	56	46	59	55	63	48	43
47	72	41	51	67	44	53	63	58	63
50	49	56	57	48	55	55	53	63	35

MATHEMATICS – Higher Level (Core)

- 6.** A group of 100 IB students was given a maths test that was graded out of 20. The following is the distribution of the marks obtained:

mark	9	10	11	12	13	14	15	16	17	18	19
number of students	1	1	3	5	8	13	19	24	14	10	2

- (a) Write down the mode.
(b) Draw a cumulative frequency graph
(c) Calculate the mean.
(d) Find the median.
(e) Find the upper and lower quartiles.
(f) Another group of 50 students had a mean mark of 17.16 on the same test. Calculate the mean of the entire group of 150 students.
- 7.** A biologist measures the lengths of 60 mature fern fronds to the nearest centimeter. The results are summarized in the table below:

Fronde Length (cm)	Frequency
10 – 14	2
15 – 19	6
20 – 24	8
25 – 29	10
30 – 34	15
35 – 39	9
40 – 44	6
45 – 49	4

- (a) Write down the modal class.
(b) Draw a cumulative frequency graph
(c) Calculate the mean.
(d) Find the median.
- 8.** For a mathematics project, Eun-Kee timed the length of 30 popular Korean songs to the nearest second. His raw data is presented below:

185 230 205 215 217 206 192 187 207 245 205 181
216 227 239 214 242 248 193 222 217 219 204 234
227 236 234 217 186 236

- (a) Complete the frequency and cumulative frequency distribution table using class intervals of 10 seconds.
(b) Use your table to calculate the mean.
(c) Re-calculate the mean using the raw data.

9. The masses of a sample of new potatoes were measured to the nearest gram and are summarized below. Calculate the mean of the data.

Mass(g)	Frequency
10 – 19	2
20 – 29	14
30 – 39	21
40 – 49	73
50 – 59	42
60 – 69	13
70 – 79	9
80 – 89	4
90 – 99	2

10. Foodcity supermarket recorded the length of time, to the nearest minute, that a sample of 200 cars was parked in their car park. The results were:

Time (minutes)	Frequency
0 – 14	13
15 – 29	23
30 – 44	32
45 – 59	33
60 – 74	27
75 – 89	20
90 – 104	12
105 – 119	11
120 – 134	10
135 – 149	11
150 – 165	8

- (a) Draw the cumulative frequency curve and use it to estimate the upper and lower quartiles.
 (b) Estimate the 80th percentile.
 (c) Estimate the percentage of cars parking for more than 50 minutes.
 (d) Calculate the mean time parked for the sample of cars.
11. The heights of 10 students, to the nearest centimeter, are as follows. State the range and use a table to calculate the standard deviation.

172 169 163 175 182 170 165 176 177 169

MATHEMATICS – Higher Level (Core)

- 12.** The scores of 25 students in a quiz out of 10 are presented below. Use a table to calculate the mean and standard deviation.

7 6 7 4 5 6 4 8 7 6
8 4 5 5 6 7 5 7 4 3
6 4 9 5 7

Verify your results by using the statistical functions found on your calculator.

- 13.** A scientific researcher weighs a random sample of 30 lizards and records their weights to the nearest gram. Use your calculator to find the sample mean and standard deviation. Provide an unbiased estimate of the population standard deviation.

21 18 15 20 18 17 12 23 19 19
17 20 13 15 17 21 18 14 13 18
22 17 15 12 25 15 16 18 16 17

- 14.** The scores of 100 students in a test out of 10 were:

score	3	4	5	6	7	8	9	10
frequency	5	11	19	24	21	12	6	2

- (a) Find the median.
(b) State the range.
(c) Find the upper and lower quartiles.
(d) State the inter-quartile range.
(e) Calculate the mean.
(f) Calculate the standard deviation.
- 15.** For a mathematics project, Eun-Kee timed the length of 30 popular Korean songs to the nearest second. His raw data is presented in Q.8 and below:

185 230 205 215 217 206 192 187 207 245 205 181
216 227 239 214 242 248 193 222 217 219 204 234
227 236 234 217 186 236

Use your calculator to find the standard deviation, and provide an estimate of the standard deviation of all Korean popular songs.

- 16.** The masses of a sample of new potatoes were measured to the nearest gram and are summarized in Q.9 and below. Estimate the standard deviation of weights of new potatoes.

Mass(g)	Frequency
10 – 19	2
20 – 29	14
30 – 39	21
40 – 49	73
50 – 59	42
60 – 69	13
70 – 79	9
80 – 89	4
90 – 99	2

14.1 MULTIPLICATION PRINCIPLE

14.1.1 DEFINITION

Permutations

Permutations represents a counting process where the **order must be taken into account**.

For example, the number of permutations of the letters A, B, C and D, if only two are taken at a time, can be enumerated as

AB, AC, AD, BA, BC, BD, CA, CB, CD, DA, DB, BC

That is, AC is a different permutation from CA (different order).

Instead of **permutation** the term **arrangement** is often used.

This definitions lead to a number of **Counting Principles** which we now look at.

14.1.2 MULTIPLICATION PRINCIPLE

Rule 1: If any one of n different mutually exclusive and exhaustive events can occur on each of k trials, the number of possible outcomes is equal to n^k .

For example, if a die is rolled twice, there are a total of $6^2 = 36$ possible outcomes.

Rule 2: If there are n_1 events on the first trial, n_2 events on the second trial, and so on, and finally, n_k events on the k th trial, then the number of possible outcomes is equal to $n_1 \times n_2 \times \dots \times n_k$.

For example, if a person has three different coloured pairs of pants, four different shirts, five different ties and three different coloured pairs of socks, the total number of different ways that this person can dress is equal to $3 \times 4 \times 5 \times 3 = 180$ ways.

Rule 3: The total number of ways that n different objects can be arranged in order is equal to $n \times (n - 1) \times (n - 2) \times \dots \times 3 \times 2 \times 1$.

Because of the common usage of this expression, we use the factorial notation. That is, we write

$$n! = n \times (n - 1) \times (n - 2) \times \dots \times 3 \times 2 \times 1$$

which is read as **n factorial**. Notice also that $0!$ is defined as 1, i.e., $0! = 1$.

For example, in how many ways can 4 boys and 3 girls be seated on a park bench? In this case any one of the seven children can be seated at one end, meaning that the adjacent position can be

MATHEMATICS – Higher Level (Core)

filled by any one of the remaining six children, similarly, the next adjacent seat can be occupied by any one of the remaining 5 children, and so on . . .

Therefore, in total there are $7 \times 6 \times 5 \times 4 \times 3 \times 2 \times 1 = 7! = 5040$ possible arrangements.

Using the TI-83, we have:

Enter 7:

Select **MATH** and **PRB**: Select option **4: !** and press **ENTER**:

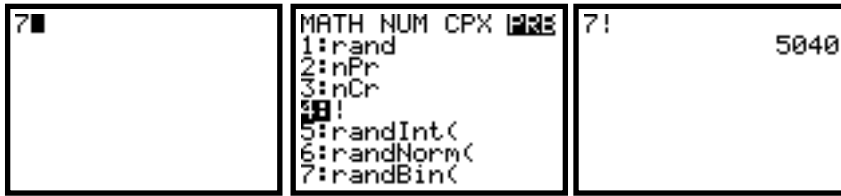

EXAMPLE 14.1

John wishes to get from town A to town C via town B. There are three roads connecting town A to town B and 4 roads connecting town B to town C. In how many different ways can John get from town A to town C?

S
o
l
u
t
i
o
n

We start by visualising this situation:

Consider the case where John uses Road 1 first.

The possibilities are:

- Road 1 then *a*,
- Road 1 then *b*,
- Road 1 then *c*,
- Road 1 then *d*.

That is, there are 4 possible routes.

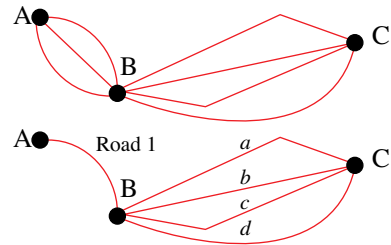

Then, for each possible road from A to B there are another 4 leading from B to C.

All in all, there are $4 + 4 + 4 = 3 \times 4 = 12$ different ways John can get from A to C via B.

EXAMPLE 14.2

Using the following street network, in how many different ways can a person get from point P to point Q if they can only move from left to right

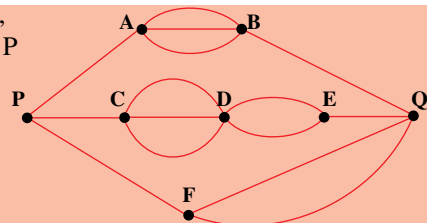

S
o
l
u
t
i
o
n

In travelling from P to Q there are:

- $3 = 1 \times 3 \times 1$ paths (along P to A to B to Q)
- $6 = 1 \times 3 \times 2 \times 1$ paths (along P to C to D to E to Q)
- $2 = 1 \times 2$ paths (along P to F to Q)

In total there are $3 + 6 + 2 = 11$ paths

EXAMPLE 14.3

A golfer has 3 drivers, 4 tees and 5 golf balls. In how many ways can the golfer take his first hit.

S
o
l
u
t
i
o
n

We think of this problem as follows:

The golfer has 3 possible drivers to use and so the first task can be carried out in 3 ways.

The golfer has 4 possible tees to use and so the second task can be carried out in 4 ways.

The golfer has 5 golf balls to use and so the third task can be carried out in 5 ways.

Using the multiplication principle, there are a total of $3 \times 4 \times 5 = 60$ ways to take the first hit.

14.1.3 PERMUTATIONS

Based on the definition given in §14.1.1 we have the following rule:

Rule 4: Permutations:

The total number of ways of **arranging** n objects, taking r at a time is given by

$$\frac{n!}{(n-r)!}$$

Notation: We use the notation ${}^n P_r$ (read as “n-p-r”) to denote $\frac{n!}{(n-r)!}$.

That is, ${}^n P_r = \frac{n!}{(n-r)!}$.

For example, the total number of arrangements of 8 books on a bookshelf if only 5 are used is

$$\text{given by } {}^8 P_5 = \frac{8!}{(8-5)!} = \frac{8!}{3!} = 6720.$$

When using the TI-83, we can either use the same approach as in the previous example or use the **nPr** function:

Type the first number, **8**, then select **MATH** and **PRB**, then select option **2:nPr**, enter the second number, **5**, and then press **ENTER**:

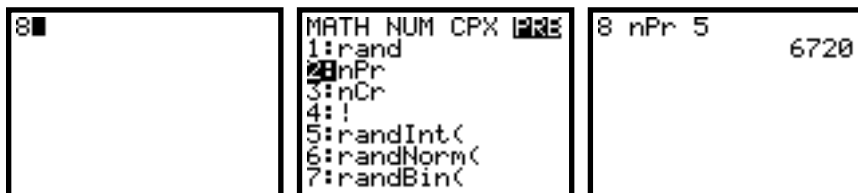
**EXAMPLE 14.4**

In how many ways can 5 boys be arranged in a row

- using three boys at a time?
- using 5 boys at a time?

S
o
l
u
t
i
o
n

We have 5 boys to be arranged in a row with certain constraints.

- (a) The constraint is that we can only use 3 boys at a time. In other words, we want the number of arrangements (permutations) of 5 objects taken 3 at a time.

From rule 4: $n = 5, r = 3,$

$$\text{Therefore, number of arrangements} = {}^5P_3 = \frac{5!}{(5-3)!} = \frac{120}{2} = 60$$

- (b) This time we want the number of arrangements of 5 boys taking all 5 at a time.

From rule 4: $n = 5, r = 5,$

$$\text{Therefore, number of arrangements} = {}^5P_5 = \frac{5!}{(5-5)!} = \frac{120}{0!} = 120$$

Box method

Problems like Example 14.4 can be solved using a method known as “the box method”. In that particular example, part (a) can be considered as filling three boxes (with only one object per box) using 5 objects:

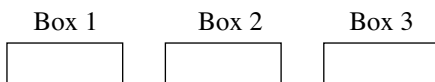

The first box can be filled in 5 different ways (as there are 5 possibilities available). Therefore we ‘place 5’ in box 1:

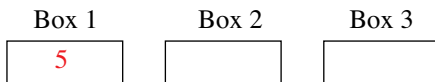

Now, as we have used up one of the objects (occupying box 1), we have 4 objects left that can be used to fill the second box. So, we ‘place 4’ in box 2:

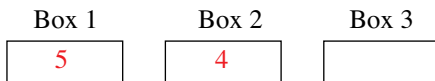

At this stage we are left with three objects (as two of them have been used). Meaning that there are 3 possible ways in which the third box can be filled. So, we ‘place 3’ in box 3:

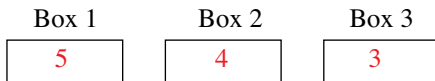

This is equivalent to saying, that we can carry out the first task in 5 different ways, the second task in 4 different ways and the third task in 3 different ways. Therefore, using the multiplication principle we have that the total number of arrangements is $5 \times 4 \times 3 = 60$.

Comparing this to the expression ${}^5P_3 = \frac{5!}{(5-3)!}$ we have $\frac{5!}{(5-3)!} = \frac{5!}{2!} = \frac{5 \times 4 \times 3 \times 2 \times 1}{2 \times 1}$

$$= 5 \times 4 \times 3$$

$$= 60$$

i.e., the last step in the evaluation process is the same as the step used in the ‘box method’.

EXAMPLE 14.5

Vehicle licence plates consist of two letters from a 26–letter alphabet, followed by a three–digit number whose first digit cannot be zero. How many different licence plates can there be?

We have a situation where there are five positions to be filled:

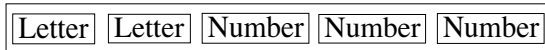

That is, the first position must be occupied by one of 26 letters, similarly, the second position must be occupied by one of 26 letters. The first number must be made up of one of nine different digits (as zero must be excluded), whilst the other two positions have 10 digits that can be used. Therefore, using Rule 2, we have:

$$\text{Total number of arrangements} = 26 \times 26 \times 9 \times 10 \times 10 = 608400 .$$

EXAMPLE 14.6

How many 5-digit numbers greater than 40 000 can be formed from the digits 0, 1, 2, 3, 4, and 5 if

- (a) there is no repetition of digits allowed?
 (b) repetition of digits is allowed?

- (a) Consider the five boxes

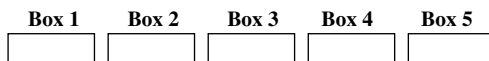

Only the digits 4 and 5 can occupy the first box (so as to obtain a number greater than 40 000). So there are 2 ways to fill box 1:

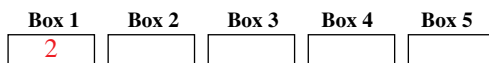

Box 2 can now be filled using any of the remaining 5 digits. So, there are 5 ways of filling box 2:

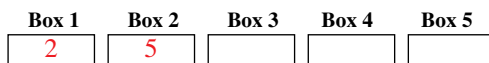

We now have 4 digits left to be used. So, there are 4 ways of filling box 3:

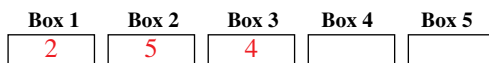

Continuing in this manner we have:

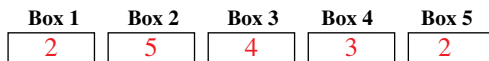

Then, using the multiplication principle we have $2 \times 5 \times 4 \times 3 \times 2 = 240$ arrangements.

Otherwise, we could have relied on rule 4 and obtained $2 \times {}^5P_4 = 2 \times 120 = 240$

- (b) As in part (a), only the digits 4 and 5 can occupy the first box.

If repetition is allowed, then boxes 2 to 5 can each be filled using any of the 6 digits:

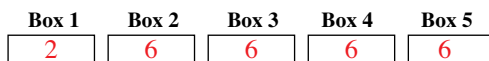

Using the multiplication principle there are $2 \times 6 \times 6 \times 6 \times 6 = 2592$ arrangements.

MATHEMATICS – Higher Level (Core)

However, one of these arrangements will also include the number 40 000. Therefore, the number of 5 digit numbers greater than 40 000 (when repetition is allowed) is given by $2592 - 1 = 2591$.

EXAMPLE 14.7

Find n if ${}^n P_3 = 60$.

S
o
l
u
t
i
o
n

$$\begin{aligned} {}^n P_3 = 60 &\Leftrightarrow \frac{n!}{(n-3)!} = 60 \\ \Leftrightarrow \frac{n(n-1)(n-2)(n-3)!}{(n-3)!} &= 60 \\ \Leftrightarrow n(n-1)(n-2) &= 60 \\ \Leftrightarrow n^3 - 3n^2 + 2n &= 60 \\ \Leftrightarrow n^3 - 3n^2 + 2n - 60 &= 0 \end{aligned}$$

Using the TI-83 to solve this polynomial, we have:

$$\text{i.e., } n = 5.$$

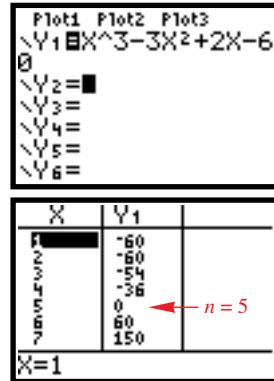

EXAMPLE 14.8

How many different arrangements of the letters of the word HIPPOPOTAMUS are there?

S
o
l
u
t
i
o
n

The word ‘HIPPOPOTAMUS’ is made up of 12 letters, unfortunately, they are not all different! Meaning that although we can swap the three P’s with each other, the word will remain the same.

Now, the total number of times we can re-arrange the Ps (and not alter the word) is $3! = 6$ times (as there are three Ps). Therefore, if we ‘blindly’ use Rule 2, we will have increased the number of arrangements 6 fold.

Therefore, we will need to divide the total number of ways of arranging 12 objects by 6.

$$\text{That is, } \frac{12!}{3!} = 79833600.$$

However, we also have 2 Os, and so, the same argument holds. So that in fact, we now

$$\text{have a total of } \frac{12!}{3! \times 2!} = 39916800 \text{ arrangements.}$$

This example is a special case of **permutations with repetitions**:

Rule 5: The number of permutations of n objects of which n_1 are identical, n_2 are

identical, \dots , n_k are identical is given by $\frac{n!}{n_1! \times n_2! \times \dots \times n_k!}$.

EXERCISES 14.1

1. A, B and C are three towns. There are 5 roads linking towns A and B and 3 roads linking towns B and C. How many different paths are there from town A to town C via town B?
2. In how many ways can 5 letters be mailed if there are
 - (a) 2 mail boxes available?
 - (b) 4 mail boxes available?
3. There are 4 letters to be placed in 4 letter boxes. In how many ways can these letters be mailed if
 - (a) only one letter per box is allowed?
 - (b) there are no restrictions on the number of letters per box?
4. Consider the cubic polynomial $p(x) = ax^3 + bx^2 - 5x + c$.
 - (a) If the coefficients, a , b and c come from the set $\{-3, -1, 1, 3\}$, find the number of possible cubics if no repetitions are allowed.
 - (b) Find the number of cubics if the coefficients now come from $\{-3, -1, 0, 1, 3\}$ (again without repetitions).

5. The diagram alongside shows the possible routes linking towns A, B, C and D.



A person leaves town A for town C. How many different routes can be taken if the person is always heading towards town C

6. In how many different ways can Susan get dressed if she has 3 skirts, 5 blouses, 6 pairs of socks and 3 pairs of shoes to choose from?
7. In how many different ways can 5 different books be arranged on a shelf?
8. In how many ways can 8 different boxes be arranged taking 3 at a time?
9. How many different signals can be formed using 3 flags from 5 different flags.
10. Three Italian, two Chemistry and four Physics books are to be arranged on a shelf. In how many ways can this be done
 - (a) if there are no restrictions?
 - (b) if the Chemistry books must remain together?
 - (c) if the books must stay together by subject?
11. Find n if ${}^n P_2 = 380$.
12. 5 boys and 5 girls, which include a brother-sister, pair are to be arranged in a straight line. Find the number of possible arrangements if
 - (a) there are no restrictions.
 - (b) the tallest must be at one end and the shortest at the other end.
 - (c) the brother and sister must be
 - i. together
 - ii. separated

13. In how many ways can the letters of the word Mississippi be arranged?
14. In how many ways can three yellow balls, three red balls and four orange balls be arranged in a row if the balls are identical in every way other than their colour?
15. In a set of 8 letters, m of them are the same and the rest different. If there are 1680 possible arrangements of these 8 letters, how many of them are the same?

14.2 COMBINATIONS

Combinations

On the otherhand, combinations represent a counting process where the order has no importance. For example, the number of combinations of the letters A, B, C and D, if only two are taken at a time, can be enumerated as:

AB, AC, AD, BC, BD, CD,

That is, the combination of the letters A and B, whether written as AB or BA, is considered as being the same.

Instead of **combination** the term **selection** is often used.

Rule 6: Combinations:

The total number of ways of **selecting** n objects, taking r at a time is given by

$$\frac{n!}{(n-r)!r!}$$

Notation: We use the notation $\binom{n}{r}$ (read as “n-c-r”) to denote $\frac{n!}{(n-r)!r!}$.

That is, $\binom{n}{r} = \frac{n!}{(n-r)!r!}$. Note: Sometimes ${}^n C_r$ is used instead of $\binom{n}{r}$.

For example, in how many ways can 5 books be selected from 8 different books? In this instance, we are talking about selections and therefore, we are looking at combinations. Therefore we have, the selection of 8 books taking 5 at a time is equal to

$$\binom{8}{5} = \frac{8!}{(8-5)!5!} = \frac{8!}{3!5!} = 56$$

Using the TI-83 we can make use of the **nCr** function:

Type the first number, **8**, then select **MATH** and **PRB**, then select option **3:nCr**, enter the second number, **5**, and then press **ENTER**:

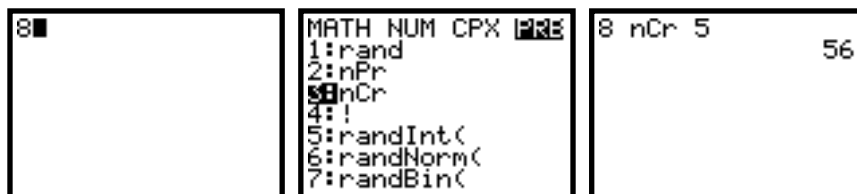

EXAMPLE 14.9

A sports committee at the local hospital consists of 5 members. A new committee is to be elected, of which 3 members must be women and 2 members must be men. How many different committees can be formed if there were originally 5 women and 4 men to select from?

**S
o
l
u
t
i
o
n**

First we look at the number of ways we can select the women members (using Rule 6):

We have to select 3 from a possible 5, therefore, this can be done in ${}^5C_3 = 10$ ways.

Similarly, the men can be selected in ${}^4C_2 = 6$ ways.

Using Rule 2, we have that the total number of possible committees = ${}^5C_3 \times {}^4C_2 = 60$.

EXAMPLE 14.10

A committee of 3 men and 2 women is to be chosen from 7 men and 5 women. Within the 12 people there is a husband and wife. In how many ways can the committee be chosen if it must contain either the wife or the husband but not both?

**S
o
l
u
t
i
o
n**

Case 1: Husband included

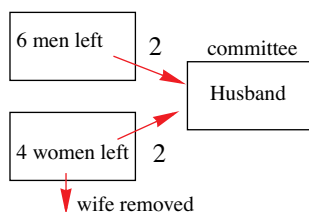

If the husband is included, the wife must be removed (so that she cannot be included). We then have to select 2 more men from the remaining 6 men and 2 women from the remaining 4 women.

This is done in ${}^6C_2 \times {}^4C_2 = 90$ ways

Case 2: Wife included

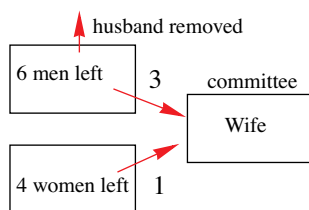

If the wife is included, the husband must be removed. We then have to select 3 men from the remaining 6 men and 1 woman from the remaining 4 women.

This is done is ${}^6C_3 \times {}^4C_1 = 80$ ways

Therefore there are a total of ${}^6C_2 \times {}^4C_2 + {}^6C_3 \times {}^4C_1 = 90 + 80 = 170$ possible committees.

EXERCISES 14.2

1. In how many ways can 5 basketball players be selected from 12 players?
2. A tennis club has 20 members.
 - (a) In how many ways can a committee of 3 be selected.
 - (b) In how many ways can this be done if the captain must be on the committee?

MATHEMATICS – Higher Level (Core)

3. In how many ways can 3 red balls, 4 blue balls and 5 white balls be selected from 5 red balls, 5 blue balls and 7 white balls?
4. In how many ways can 8 objects be divided into 2 groups of 4 objects?
5. A cricket training squad consists of 4 bowlers, 8 batsmen, 2 wicket keepers and 4 fielders. From this squad a team of 11 players is to be selected. In how many ways can this be done if the team must consist of 3 bowlers, 5 batsmen, 1 wicket keeper and 2 fielders?
6. A class consists of 12 boys of whom 5 are prefects. How many committees of 8 can be formed if the committee is to have
 - (a) 3 prefects?
 - (b) at least 3 prefects?
7. In how many ways can 3 boys and 2 girls be arranged in a row if a selection is made from 6 boys and 5 girls?
8. If $\binom{n}{3} = 56$ show that $n^3 - 3n^2 + 2n - 336 = 0$. Hence find n .
9. In how many ways can a jury of 12 be selected from 9 men and 6 women so that there are at least 6 men and no more than 4 women on the jury.
10. Show that $\binom{n+1}{3} - \binom{n-1}{3} = (n-1)^2$. Hence find n if $\binom{n+1}{3} - \binom{n-1}{3} = 16$.

EXERCISES 14.3

- MISCELLANEOUS QUESTIONS

1. Five different coloured flags can be run up a mast.
 - (a) How many different signals can be produced if all five flags are used?
 - (b) How many different signals can be produced if any number of flags is used?
2. In how many different ways can 7 books be arranged in a row?
3. In how many different ways can three boys and four girls be seated in a row?
In how many ways can this be done if
 - (a) no two girls are sitting next to each other,
 - (b) the ends are occupied by girls?
4. In how many different ways can 7 books be arranged in a row if
 - (a) 3 specified books must be together,
 - (b) two specified books must occupy the ends.
5. A school council consists of 12 members, 6 of whom are parents, 2 are students, the Principal and the remainder are teachers. The school captain and vice-captain must be on the council. If there are 10 parents and 8 teachers nominated for positions on the school council, how many different committees can there be?

- 6.** A committee of 5 men and 5 women is to be selected from 9 men and 8 women. How many possible committees can be formed?
Amongst the 17 people, there is a married couple. If the couple cannot serve together, how many committees could there be?
- 7.** A sports team consists of 5 bowlers (or pitchers), 9 batsmen and 2 keepers (or back-stops). How many different teams of 11 players can be chosen from the above squad if the team consists of
(a) 4 bowlers (pitchers), 6 batsmen and 1 keeper (back-stop)?
(b) 6 batsmen (pitchers) and at least 1 keeper (back-stop)?
- 8.** Twenty people are to greet each other by shaking hands. How many hand shakes are there?
- 9.** How many arrangements of the letters of the word “MARRIAGE” are possible?
- 10.** How many arrangements of the letters of the word “COMMISSION” are possible?
- 11.** A committee of 4 is to be selected from 7 men and 6 women. In how many ways can this be done if
(a) there are no restrictions?
(b) there must be an equal number of men and women on the committee?
(c) there must be at least one member of each sex on the committee?
- 12.** Prove that (a) $\binom{n}{r} + \binom{n}{r+1} = \binom{n+1}{r+1}$. (b) ${}^{n+1}P_r = {}^nP_r + r \times {}^nP_{r-1}$.
- 13.** A circle has n points on its circumference. How many chords joining pairs of points can be drawn?
- 14.** A circle has n points on its circumference. What is the maximum number of points of intersection of chords inside the circle?
- 15.** (a) Show that $2^n = \sum_{r=0}^n \binom{n}{r}$.
(b) In how many ways can 8 boys be divided into two unequal sets?
- 16.** Whilst at the library, Patrick decides to select 5 books from a group of 10. In how many different ways can Patrick make the selection?
- 17.** A fish tank contains 5 gold coloured tropical fish and 8 black coloured tropical fish.
(a) In how many ways can five fish be selected?
(b) If a total of 5 fish have been selected from the tank, how many of these contain two gold fish?
- 18.** In how many ways can 4 people be accommodated if there are 4 rooms available?
- 19.** A car can hold 3 people in the front seat and 4 in the back seat. In how many ways can 7 people be seated in the car if John and Samantha must sit in the back seat and there is only one driver?

MATHEMATICS – Higher Level (Core)

- 20.** In how many ways can six men and two boys be arranged in a row if:
- (a) the two boys are together?
 - (b) the two boys are not together?
 - (c) there are at least three men separating the boys?
- 21.** In how many ways can the letters of the word “TOGETHER” be arranged? In how many of these arrangements are all the vowels together?
- 22.** In how many ways can 4 women and 3 men be arranged in a row, if there are 8 women and 5 men to select from?
- 23.** In how many ways can 4 women and 3 men be arranged in a circle? In how many ways can this be done if the tallest woman and shortest man must be next to each other?
- 24.** In how many ways can 5 maths books, 4 physics books and 3 biology books be arranged on a shelf if subjects are kept together?
- 25.** How many even numbers of 4 digits can be formed using 5, 6, 7, 8 if
- (a) no figure is repeated?
 - (b) repetition is allowed?
- 26.** 5 men and 5 women are to be seated around a circular table. In how many ways can this be done if the men & women alternate?
- 27.** A class of 20 students contains 5 student representatives. A committee of 8 is to be formed. How many different committees can be formed if there are
- (a) only 3 student representatives?
 - (b) at least 3 student representatives?
- 28.** How many possible juries of 12 can be selected from 12 women & 8 men so that there are at least 5 men and not more than 7 women?
- 29.** In how many ways can 6 people be seated around a table if 2 friends are always
- (a) together?
 - (b) separated?

15.1 PROBABILITY

We are often faced with statements that reflect an element of likelihood, For example, “It is likely to rain later in the day” or “What are the chances that I roll a six?”. Such statements relate to a level of uncertainty (or indeed, a level of certainty). It is this element of likelihood in which we are interested. In particular, we need to find a measure of this likelihood — i.e., the associated probability of particular events.

15.1.1 PROBABILITY AS A LONG-TERM RELATIVE FREQUENCY

An experiment is repeated in such a way that a series of independent and identical trials are produced, so that a particular event A is observed to either occur or not occur. We let N be the total number of trials carried out and $n(A)$ (or $|A|$) be the number of times that the event A was observed.

We then call the ratio $\frac{n(A)}{N}$ (or $\frac{|A|}{N}$) the **relative frequency** of the event A . This value provides some indication of the likelihood of the event A occurring.

In particular, for large values of N we find that the ratio $\frac{n(A)}{N}$ tends to a number called the **probability** of the event A , which we denote by $p(A)$ or $P(A)$.

As $0 \leq n(A) \leq N$, this number, $P(A)$, must lie between 0 and 1 (inclusive), i.e., $0 \leq P(A) \leq 1$.

A more formal definition is as follows:

If a random experiment is repeated N times, in such a way that each of the trials is identical and independent, where $n(A)$ is the number of times **event A** has occurred after N trials, then

$$\text{As } N \rightarrow \infty, \frac{n(A)}{N} \rightarrow P(A).$$

It is possible to provide a graph of such a situation, which shows that as N increases, the ratio $\frac{n(A)}{N}$ tends towards some value p , where in fact, $p = P(A)$.

Such a graph is called a **relative frequency graph**.

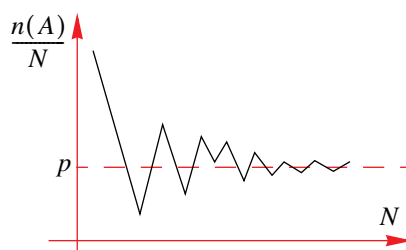

15.1.2 THEORETICAL PROBABILITY

When the circumstances of an experiment are always identical, we can arrive at a value for the probability of a particular event by using mathematical reasoning, often based on an argument reflecting some form of symmetry (i.e., without the need to repeatedly perform the experiment). This type of probability is called **theoretical probability**.

MATHEMATICS – Higher Level (Core)

For example, when we roll a die, every possible outcome, known as the **sample space**, can be listed as $U = \{1, 2, 3, 4, 5, 6\}$ (sometimes the letter ϵ is used instead of U). The probability of obtaining a “four” (based on considerations of **symmetry of equal likelihood**) is given by $\frac{1}{6}$.

Such a probability seems obvious, as we would argue that;

“Given there are six possible outcomes and each outcome is equally likely to occur

(assuming a fair die), then the chances that a “four” occurs must be one in six, i.e., $\frac{1}{6}$.”

15.1.3 LAWS OF PROBABILITY

We will restrict our arguments to **finite sample spaces**. Recall, that a **sample space** is the set of every possible outcome of an experiment, and that an **event** is any subset of the sample space. This relationship is often represented with a Venn diagram:

The Venn diagram shows the sample space U , with the event A , as a subset.

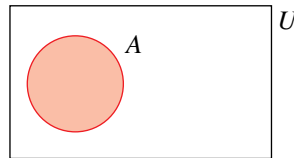

15.1.4 DEFINITION OF PROBABILITY

If an experiment has equally likely outcomes and of these the event A is defined, then the **theoretical probability of event A** occurring is given by

$$P(A) = \frac{n(A)}{n(U)} = \frac{\text{Number of outcomes in which A occurs}}{\text{Total number of outcomes in the sample space}}$$

Where $n(U)$ is the total number of possible outcomes in the sample space, U , (i.e., $n(U) = N$).

As a consequence of this definition we have what are known as the **axioms of probability**:

1. $0 \leq P(A) \leq 1$
2. $P(\emptyset) = 0$ and $P(\epsilon) = 1$
That is, if $A = \emptyset$, then the event A can never occur.
 $A = U$ implies that the event A is a certainty.
3. If A and B are both subsets of U and are mutually exclusive, then $P(A \cup B) = P(A) + P(B)$.

Note:

Two events A and B are said to be **mutually exclusive** (or disjoint) if they have no elements in common, i.e., if $A \cap B = \emptyset$.

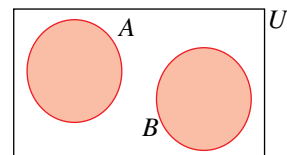

EXAMPLE 15.1

A fair die is thrown. List the sample space of the experiment and hence find the probability of observing:

- (a) a multiple of 3
- (b) an odd number.

Are these events mutually exclusive?

S
o
l
u
t
i
o
n

- (a) The sample space is $U = \{1, 2, 3, 4, 5, 6\}$.
Let A be the event ‘obtaining a multiple of 3’.

$$\text{We then have that } A = \{3, 6\}. \text{ Therefore, } P(A) = \frac{n(A)}{n(U)} = \frac{2}{6} = \frac{1}{3}.$$

- (b) Let B be the event ‘obtaining an odd number’.

$$\text{Here } B = \{1, 3, 5\} \text{ and so } P(B) = \frac{n(B)}{n(U)} = \frac{3}{6} = \frac{1}{2}.$$

In this case, $A = \{3, 6\}$ and $B = \{1, 3, 5\}$, so that $A \cap B = \{3\}$. Therefore, as $A \cap B \neq \emptyset$ A and B are not mutually exclusive.

E **X** **A** **M** **P** **L** **E** **1** **5** **.** **2**

Two coins are tossed. Find the probability that:

- (a) two tails are showing (b) a tail is showing.

S
o
l
u
t
i
o
n

Let H denote the event a head is showing and T the event a tail is showing. This means that the sample space (with two coins) is given by $U = \{HH, HT, TH, TT\}$.

- (a) The event that two tails are showing is given by the event $\{TT\}$, therefore, we have

$$\text{that } P(\{TT\}) = \frac{n(\{TT\})}{n(U)} = \frac{1}{4}.$$

- (b) The event that one tail is showing is given by $\{HT, TH\}$, therefore, we have that

$$P(\{HT, TH\}) = \frac{n(\{HT, TH\})}{n(U)} = \frac{2}{4} = \frac{1}{2}.$$

E **X** **A** **M** **P** **L** **E** **1** **5** **.** **3**

A card is drawn from a standard deck of 52 playing cards. What is the probability that a diamond card is showing?

S
o
l
u
t
i
o
n

Let D denote the event “a diamond card is selected”.

This means that $n(D) = 13$ as there are 13 diamond cards in a standard deck of cards.

$$\text{Therefore, } P(D) = \frac{n(D)}{n(U)} = \frac{13}{52} = \frac{1}{4}.$$

15.1.5 PROBLEM SOLVING STRATEGIES IN PROBABILITY

When dealing with probability problems it is often useful to use some form of diagram to help ‘visualize’ the situation. **Diagrams** can be in the form of

1. Venn diagrams.
2. Tree diagrams.
3. Lattice diagrams.
4. Karnaugh maps (probability tables).
5. As a last resort, any form of diagram that clearly displays the process under discussion (e.g. flow chart).

It is fair to say that some types of diagrams lend themselves well to particular types of problems. These will be considered in due course.

EXAMPLE 15.4

Find the probability of getting a sum of 7 on two throws of a die.

S
o
l
u
t
i
o
n

In this instance, we make use of a lattice diagram to display all possible outcomes. From the diagram, we can list the required event (and hence find the required probability):

Let S denote the event “A sum of seven is observed”. From the lattice diagram, we see that there are 6 possibilities where a sum of seven occurs.

In this case we have

$$S = \{(1, 6), (2, 5), (3, 4), (4, 3), (5, 2), (6, 1)\}.$$

Therefore, we have that $P(S) = \frac{n(S)}{n(U)} = \frac{6}{36} = \frac{1}{6}$

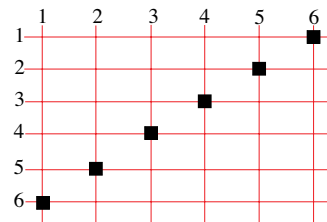

EXERCISES 15.1

1. From a bag containing 6 white and 4 red balls, a ball is drawn at random. What is the probability that the ball selected is
 - (a) red
 - (b) white
 - (c) not white
2. From an urn containing 14 marbles of which 4 are blue and 10 are red, a marble is selected at random. What is the probability that
 - (a) the marble is blue
 - (b) the marble is red
3. A letter is chosen at random from the letters of the alphabet. What is the probability that
 - (a) the letter is a vowel
 - (b) the letter is a consonant

- 4.** A coin is tossed twice. List the sample space and find the probability of observing
- two heads.
 - at least one head.
- 5.** A coin is tossed three times. List the sample space and find the probability that
- two heads, show uppermost.
 - at least two heads show uppermost.
 - three heads or three tails are showing.
- 6.** A letter is chosen at random from the word FERTILITY. Find the probability that the letter chosen is
- a T
 - an I
 - a consonant
 - a vowel.
- 7.** A bag has 20 coins numbered from 1 to 20. A coin is drawn at random and its number is noted.
What is the probability that the coin drawn
- has an even number on it?
 - has a number that is divisible by 3?
 - has a number that is divisible by 3 or 5?
- 8.** A die is rolled twice. Use a lattice diagram to illustrate the sample space. What is the probability of observing
- at least one five
 - a four and a three
 - a pair
 - a sum of eight
- 9.** A family has three children. List the sample space and hence find the probability that
- there are 3 boys.
 - there are 2 boys and 1 girl.
 - there are at least two girls.
- 10.** A card is selected from a pack of 52 cards. Find the probability that the card is
- red
 - a heart
 - red and a heart
- 11.** From an urn containing 16 cubes of which 6 are red, 4 are white and 6 are black, a cube is drawn at random.
Find the probability that the cube is
- red
 - white
 - black
 - red or black
- 12.** A coin and a die are tossed simultaneously. Draw a lattice diagram to depict this situation.
- Using your lattice diagram, list the sample space.
 - What is the probability of observing a tail and an even number?
- 13.** A die is thrown three times. Find the probability of observing
- three sixes.
 - three even numbers.
 - two odd numbers.
- Hint: You might need to draw a three dimensional lattice diagram.

15.2 PROBABILITY & VENN DIAGRAMS

From the axioms of probability we can develop further rules to help solve problems that involve chance. We illustrate these rules with the aid of Venn diagrams.

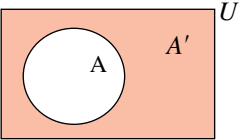
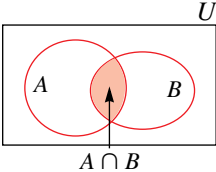
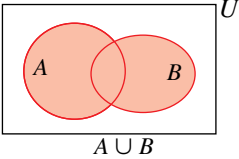
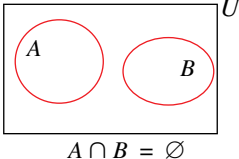
Event	Set language	Venn diagram	Probability result
The complement of A is denoted by A' .	A' is the complement to the set A , i.e., the set of elements that do not belong to the set A .		$P(A') = 1 - P(A)$ $P(A')$ is the probability that event A does not occur.
The intersection of A and B : $A \cap B$	$A \cap B$ is the intersection of the sets A and B , i.e., the set of elements that belong to both the set A and the set B .		$P(A \cap B)$ is the probability that both A and B occur.
The union of events A and B : $A \cup B$	$A \cup B$ is the union of the sets A and B , i.e., the set of elements that belong to A or B or both A and B .	 $P(A \cup B) = P(A) + P(B) - P(A \cap B)$	$P(A \cup B)$ is the probability that either event A or event B (or both) occur. From this we have what is known as the ' Addition rule ' for probability:
If $A \cap B = \emptyset$ the events A and B are said to be disjoint . That is, they have no elements in common.	If $A \cap B = \emptyset$ the sets A and B are mutually exclusive .	 $P(A \cup B) = P(A) + P(B)$	If A and B are mutually exclusive events then event A and event B cannot occur simultaneously, i.e., $n(A \cap B) = 0$ $\Rightarrow P(A \cap B) = 0$ Therefore: $P(A \cup B) = P(A) + P(B)$

Although we now have a number of 'formulas' to help us solve problems that involve probability, using other forms of diagrams to clarify situations and procedures should not be overlooked.

EXAMPLE 15.5

A card is randomly selected from an ordinary pack of 52 playing cards. Find the probability that it is either a 'black card' or a 'King'.

Solution

Let B be the event ‘A black card is selected.’ and K the event ‘A King is selected’.

We first note that event B has as its elements the Jack of spades($J♠$), the Jack of clubs ($J♣$), the Queen of spades($Q♠$), the Queen of clubs($Q♣$) and so on.

This means that

$$B = \{K♠, K♣, Q♠, Q♣, J♠, J♣, 10♠, 10♣, 9♠, 9♣, 8♠, 8♣, 7♠, 7♣, 6♠, 6♣, 5♠, 5♣, 4♠, 4♣, 3♠, 3♣, 2♠, 2♣, A♠, A♣\} \text{ and}$$

$$K = \{K♠, K♦, K♥, K♣\}, \text{ so that } B \cap K = \{K♠, K♣\}.$$

Using the addition rule, $P(B \cup K) = P(B) + P(K) - P(B \cap K)$

$$\text{we have } P(B \cup K) = \frac{26}{52} + \frac{4}{52} - \frac{2}{52} = \frac{7}{13}.$$

Note the importance of subtracting $\frac{2}{52}$ as this represents the fact that we have included the event $\{K♠, K♣\}$ twice when finding B and K .

We now consider one of the problems from Exercise 15.1, but this time we make use of the addition rule.

EXAMPLE 15.6

A bag has 20 coins numbered from 1 to 20. A coin is drawn at random and its number is noted. What is the probability that the coin has a number that is divisible by 3 or by 5?

Solution

Let T denote the event “The number is divisible by 3” and S , the event “The number is divisible by 5”.

Using the addition rule we have $P(T \cup S) = P(T) + P(S) - P(T \cap S)$

Now, $T = \{3, 6, 9, 12, 15, 18\}$ and $S = \{5, 10, 15, 20\}$ so that $T \cap S = \{15\}$.

$$\text{Therefore, we have } P(T) = \frac{6}{20} \text{ and } P(S) = \frac{4}{20} \text{ and } P(T \cap S) = \frac{1}{20}.$$

$$\text{This means that } P(T \cup S) = \frac{6}{20} + \frac{4}{20} - \frac{1}{20} = \frac{9}{20}.$$

EXAMPLE 15.7

If $p(A) = 0.6$, $p(B) = 0.3$ and $p(A \cap B) = 0.2$, find

- (a) $p(A \cup B)$ (b) $p(B')$ (c) $p(A \cap B')$

Solution

(a) Using the addition formula we have, $p(A \cup B) = p(A) + p(B) - p(A \cap B)$
 $\Rightarrow p(A \cup B) = 0.6 + 0.3 - 0.2 = 0.7$

(b) Using the complementary formula, we have $p(B') = 1 - p(B) = 1 - 0.3 = 0.7$.

(c) To determine $p(A \cap B')$, we need to use a Venn diagram:

MATHEMATICS – Higher Level (Core)

Using the second Venn diagram we are now in a position to form a new formula:

$$p(A \cap B') = p(A) - p(A \cap B).$$

$$\therefore p(A \cap B') = 0.6 - 0.2 = 0.4.$$

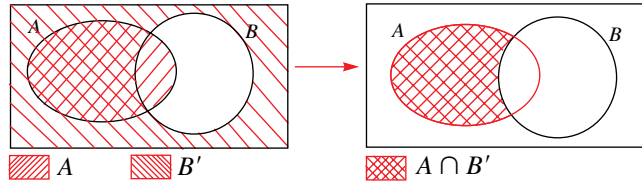

EXAMPLE 15.8

A coin is tossed three times. Find the probability of

- (a) obtaining three tails (b) obtaining at least one head.

S
o
l
u
t
i
o
n

We begin by drawing a tree diagram to describe the situation:

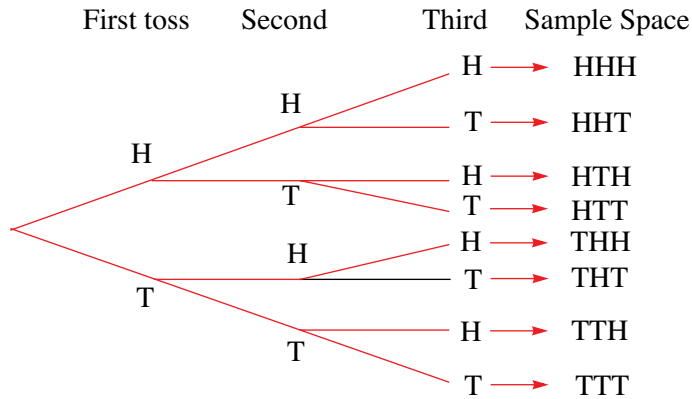

From the tree diagram we have a sample space made up of eight possible outcomes:
 $\{HHH, HHT, HTH, HTT, THH, THT, TTH, TTT\}$

- (a) Let X be the event “Obtaining three tails.”, so $X = \{TTT\}$. Therefore $P(X) = \frac{1}{8}$.
- (b) Although we can answer this question by using the tree diagram, we make use of complementary events to solve this problem.
 Notice that “At least one head.” is the complement of no heads.

$$\text{Therefore, } p(\text{At least one head}) = P(X') = 1 - P(X) = 1 - \frac{1}{8} = \frac{7}{8}.$$

EXERCISES 15.2

- A letter is chosen at random from the letters of the word TOGETHER.
 - Find the probability of selecting a T.
 - Find the probability of selecting a consonant.
 - Find the probability of not selecting an E.
- A card is drawn at random from a standard deck.
 - Find the probability that the card is an ace.

- (b) Find the probability that the card is black.
- (c) Find the probability that the card is an ace and black.
- (d) Find the probability that the card is an ace or black.

3. A letter is selected at random from the alphabet. Find the probability that the letter is a vowel or comes from the word ‘helpful’.

4. The events A and B are such that $P(A) = 0.5$, $P(B) = 0.7$ and $P(A \cap B) = 0.2$. Find

- (a) $P(A \cup B)$
- (b) $P(B')$
- (c) $P(A' \cap B)$

5. The events A and B are such that $p(A) = 0.35$, $p(B) = 0.5$ and $p(A \cap B) = 0.15$. Using a Venn diagram (where appropriate) find:

- (a) $p(A')$
- (b) $p(A \cup B)$
- (c) $p(A \cup B')$.

6. The events A and B are such that $p(A) = 0.45$, $p(B) = 0.7$ and $p(A \cap B) = 0.20$. Using a Venn diagram (where appropriate) find:

- (a) $p(A \cup B)$
- (b) $p(A' \cap B')$
- (c) $p((A \cap B)')$.

7. A coin is tossed three times.

- (a) Draw a tree diagram and from it write down the sample space.

Use the results from part (a) to find the probability of obtaining

- (b) only one tail.
- (c) at least 2 tails.
- (d) 2 tails in succession.
- (e) 2 tails.

8. In a class of 25 students it is found that 6 of the students play both tennis and chess, 10 play tennis only and 3 play neither. A student is selected at random from this group.

Using a Venn diagram, find the probability that the student.

- (a) plays both tennis and chess.
- (b) plays chess only.
- (c) does not play chess.

9. A blue and a red die are rolled together (both numbered one to six).

- (a) Draw a lattice diagram that best represents this experiment.
- (b) Find the probability of observing an odd number.
- (c) Find the probability of observing an even number with the red die.
- (d) Find the probability of observing a sum of 7
- (e) Find the probability of observing a sum of 7 or an odd number on the red die.

10. A card is drawn at random from a standard deck of 52 playing cards. Find the probability that the card drawn is

- (a) a diamond.
- (b) a club or spade.
- (c) a black card or a picture card.
- (d) a red card or a queen.

MATHEMATICS – Higher Level (Core)

- 11.** A and B are two events such that $P(A) = p$, $P(B) = 2p$ and $P(A \cap B) = p^2$.
- (a) Given that $P(A \cup B) = 0.4$, find p .
Use a Venn Diagram to help you find the following:
- (b) $P(A' \cup B)$
- (c) $P(A' \cap B')$.
- 12.** In a group of 30 students 20 hold an Australian passport, 10 hold a Malaysian passport and 8 hold both passports. The other students hold only one passport (that is neither Australian nor Malaysian). A student is selected at random.
- (a) Draw a Venn diagram which describes this situation.
- (b) Find the probability that the student has both passports.
- (c) Find the probability that the student holds neither passport.
- (d) Find the probability that the student holds only one passport.

15.3 CONDITIONAL PROBABILITY

15.3.1 INFORMAL DEFINITION OF CONDITIONAL PROBABILITY

Conditional probability works in the same way as simple probability. The only difference is that we are provided with some prior knowledge (or some extra condition about the outcome). So rather than considering the whole sample space, ϵ , given some extra information about the outcome of the experiment, we only need to concentrate on part of the whole sample space, ϵ^* . This means that the sample space is reduced from ϵ to ϵ^* . Before formalising this section, we use an example to highlight the basic idea.

EXAMPLE 15.9

- (a) In the toss of a die, find the probability of obtaining a 'Two'.
- (b) After tossing a die, it is noted that an even number appeared, what is the probability that it is a 'Two'?

S
o
l
u
t
i
o
n

- (a) This part is straight forward: $U = \{1, 2, 3, 4, 5, 6\}$, and so $P(\text{'Two'}) = \frac{1}{6}$.
- (b) This time, because *we know that an even number has occurred*, we have a new sample space, namely $U^* = \{2, 4, 6\}$. The new sample size is $n(U^*) = 3$.
Therefore, $P(\text{'Two' given that an even number showed up}) = \frac{1}{3}$.

15.3.2 FORMAL DEFINITION OF CONDITIONAL PROBABILITY

If A and B are two events, then **the conditional probability of event A given event B** is found using

$$P(A|B) = \frac{P(A \cap B)}{P(B)}, P(B) \neq 0.$$

- Note 1. If A and B are mutually exclusive then $P(A|B) = 0$.
2. From the above rule, we also have the general **Multiplication rule**:

$$P(A \cap B) = P(A|B) \times P(B)$$

It should also be noted that usually $P(A|B) \neq P(B|A)$.

EXAMPLE 15.10

Two dice numbered one to six are rolled onto a table. Find the probability of obtaining a sum of five given that the sum is seven or less.

Solution

We first draw a lattice diagram:

From the diagram we see that the new sample space is made up of 21 outcomes (black boxes) and the event we want (circled) consists of 4 outcomes.

Then, $P((X=5) \cap (X \leq 7)) = \frac{4}{36}$ and $P(X \leq 7) = \frac{21}{36}$.

Therefore, $P(X=5|X \leq 7) = \frac{\frac{4}{36}}{\frac{21}{36}} = \frac{4}{21}$.

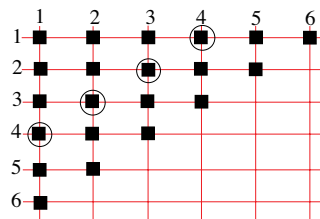
**EXAMPLE 15.11**

A box contains 2 red cubes and 4 black cubes. If two cubes are chosen at random, find the probability that both cubes are red given that

- the first cube is not replaced before the second cube is selected.
- the first cube is replaced before the second cube is selected.

Solution

Let A be the event “the first cube is red” and B be the event “the second cube is red”.

This means that the event $A \cap B$ must be “both cubes are red”.

Now, $p(A) = \frac{2}{6} = \frac{1}{3}$ (as there are 2 red cubes from a total of 6 cubes in the box).

The value of $P(B)$ depends on whether the selection is carried out with or without replacement.

- If the first cube selected is red and it is not replaced, then we only have 1 red cube left (in the box) out of a total of five cubes.

So, the probability that the second cube is red given that the first is red is $\frac{1}{5}$.

That is $p(B|A) = \frac{1}{5} \Rightarrow P(A \cap B) = P(B|A) \times P(A) = \frac{1}{5} \times \frac{1}{3} = \frac{1}{15}$.

MATHEMATICS – Higher Level (Core)

- (b) This time, because the cube is replaced, the probability that the second cube is red given that the first one is red is still $\frac{1}{3}$.

$$\text{So that, } P(B|A) = \frac{1}{3} \Rightarrow P(A \cap B) = P(B|A) \times P(A) = \frac{1}{3} \times \frac{1}{3} = \frac{1}{9}.$$

EXAMPLE 15.12

Two events A and B are such that $P(A) = 0.5$, $P(B) = 0.3$ and $P(A \cup B) = 0.6$.

Find (a) $P(A|B)$. (b) $P(B|A)$ (c) $P(A'|B)$

S
O
L
I
T
I
O
N

(a) $P(A|B) = \frac{P(A \cap B)}{P(B)}$, therefore we need to find $P(A \cap B)$.

Using the addition rule we have $P(A \cup B) = P(A) + P(B) - P(A \cap B)$

$$0.6 = 0.5 + 0.3 - P(A \cap B)$$

$$\therefore P(A \cap B) = 0.2$$

Therefore, $P(A|B) = \frac{P(A \cap B)}{P(B)} = \frac{0.2}{0.3} = \frac{2}{3}$

(b) $P(B|A) = \frac{P(B \cap A)}{P(A)} = \frac{0.2}{0.5} = 0.4$.

(c) $P(A'|B) = \frac{P(A' \cap B)}{P(B)} = \frac{P(B) - P(A \cap B)}{P(B)} = \frac{0.3 - 0.2}{0.3} = \frac{1}{3}$

15.3.3 INDEPENDENCE

The events A and B are said to be statistically independent if the probability of event B occurring is not influenced by event A occurring.

Therefore we have the mathematical definition:

Two events A and B are independent if, and only if,

$$P(A|B) = P(A) \text{ and } P(B|A) = P(B)$$

However, a more convenient definition for independence can be given as follows:

A and B are independent if, and only if

$$P(A \cap B) = P(A) \times P(B)$$

This definition can be used as a test to decide if two events are independent. However, as a rule of thumb, if two events are ‘physically independent’ then they will also be statistically independent.

There are a few points that should always be considered when dealing with independence:

1. Never assume that two events are independent unless you are absolutely certain that they are independent.
2. How can you tell if two events are independent ?
A good rule of thumb is:
If they are physically independent, they are mathematically independent.
3. Make sure that you understand the difference between mutually exclusive events and independent events.
Mutually exclusive means that the events A and B have nothing in common and so there is no intersection. i.e., $A \cap B = \emptyset \Rightarrow P(A \cap B) = 0$.
Independent means that the outcome of event A will not influence the outcome of event B i.e., $P(A \cap B) = P(A) \times P(B)$.
4. Independence need not only be for two events, it can be extended, i.e., if the events A , B and C are each independent of each other then
$$P(A \cap B \cap C) = P(A) \times P(B) \times P(C)$$
5. Showing that two events, A and B are independent, requires three steps:
 - Step 1** Evaluate the product $P(A) \times P(B)$.
 - Step 2** Determine the value of $P(A \cap B)$ using any means (other than step 1) i.e., use grids, tables, Venn diagrams, . . .
That is, you must not assume anything about A and B .
 - Step 3** If the answer using Step 1 is equal to the answer obtained in Step 2, then and only then will the events be independent. Otherwise, they are not independent.
Notice that not being independent does not therefore mean that they are mutually exclusive. They simply aren't independent. That's all.
6. Do not confuse the multiplication principle with the the rule for independence;
Multiplication principle is $P(A \cap B) = P(A|B) \times P(B)$
Independence is given by $P(A \cap B) = P(A) \times P(B)$

EXAMPLE 15.13

Two fair dice are rolled. Find the probability that two even numbers will show up.

**S
o
l
u
t
i
o
n**

Let the E_1 and E_2 denote the events “An even number on the first die.” and “An even number on the second die.” respectively.

In this case, the events are physically independent, i.e., the outcome on one die will not influence the outcome on the other die, and so we can confidently say that E_1 and E_2 are independent events.

Therefore, we have $P(E_1 \text{ and } E_2) = P(E_1 \cap E_2) = P(E_1) \times P(E_2) = \frac{1}{2} \times \frac{1}{2} = \frac{1}{4}$.

EXAMPLE 15.14

Debra has a chance of 0.7 of winning the 100 m race and a 60% chance of winning the 200 m race.

- (a) Find the probability that she only wins one race.
- (b) Find the probability that she wins both races.

**S
o
l
u
t
i
o
n**

Let W_1 denote the event “Debra wins the 100 m race.” and W_2 , the event “Debra wins the 200 m race.”.

- (a) If Debra wins only one race she must either
 win the 100 m **and** lose the 200 m **or**
 win the 200 m **and** lose the 100 m.

That is, we want $P(W_1 \cap W_2') = P(W_1) \times P(W_2') = 0.7 \times 0.4 = 0.28$ or we can multiply the probabilities because the events are independent (**why?**):

$$P(W_2 \cap W_1') = P(W_2) \times P(W_1') = 0.6 \times 0.3 = 0.18 .$$

Therefore, the required probability is $0.28 + 0.18 = 0.46$

Notice that if W_1 and W_2 are independent, then so too are their complements.

- (b) Winning both races means that Debra will win the 100 m **and** 200 m race.
 Therefore, we have $P(W_1 \cap W_2) = P(W_1) \times P(W_2) = 0.7 \times 0.6 = 0.42 .$

Notice how we have made repeated use of the word ‘**and**’, this emphasizes the fact that we are talking about the intersection of events.

EXAMPLE 15.15

Four seeds are planted, each one having an 80% chance of germinating. Find the probability that

- (a) all four seeds will germinate.
- (b) at least one seed will germinate.

**S
o
l
u
t
i
o
n**

- (a) Let G_i denote the event that the i th seed germinates.

This means that $P(G_1) = P(G_2) = P(G_3) = P(G_4) = 0.8$

It is reasonable to assume that each seed will germinate independently of the other.

$$\begin{aligned} \text{Therefore, } P(\text{All four seeds germinate}) &= P(G_1 \cap G_2 \cap G_3 \cap G_4) \\ &= P(G_1) \times P(G_2) \times P(G_3) \times P(G_4) \\ &= (0.8)^4 \\ &= 0.4096 \end{aligned}$$

- (b) Now, $p(\text{At least one seed will germinate}) = 1 - p(\text{No seeds germinate}).$
 $P(\text{Any one seed does not germinate}) = P(G_i') = 0.2$

Therefore, $P(\text{At least one seed will germinate}) = 1 - (P(G_i'))^4 = 1 - (0.2)^4 = 0.9984 .$

EXAMPLE 15.16

A bag contains 5 white balls and 4 red balls. Two balls are selected in such a way that the first ball drawn is not replaced before the next ball is drawn. Find the probability of selecting exactly one white ball.

S
o
l
u
t
i
o
n

We begin by drawing a diagram of the situation:

From our diagram we notice that there are two possible sample spaces for the second selection.

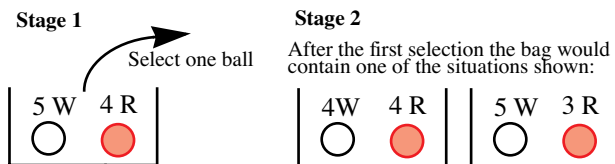

As an aid, we make use of a tree diagram, where W_i denotes the event "A white ball is selected on the i th trial" and R_i denotes the event "A red ball is selected on the i th trial".

The event "Only one white" occurs if the first ball is white **and** the second ball is red, **or** the first ball is red **and** the second ball is white.

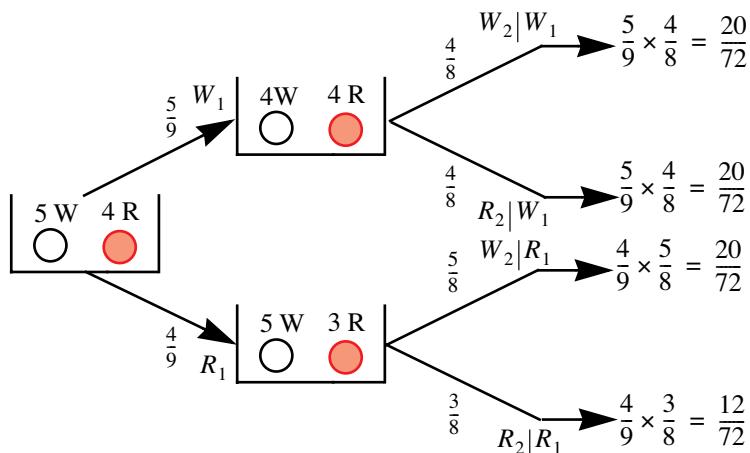

$$\begin{aligned}
 P(\text{One White ball}) &= P(W_1 \cap R_2) + P(R_1 \cap W_2) \\
 &= P(R_2|W_1) \times P(W_1) + P(W_2|R_1) \times P(R_1) \\
 &= \frac{4}{8} \times \frac{5}{9} + \frac{5}{8} \times \frac{4}{9} \\
 &= \frac{5}{9}
 \end{aligned}$$

EXERCISES 15.3

1. Two events A and B are such that $p(A) = 0.6$, $p(B) = 0.4$ and $p(A \cap B) = 0.3$. Find the probability of the following events:
- (a) $A \cup B$ (b) $A|B$ (c) $B|A$ (d) $A|B'$

MATHEMATICS – Higher Level (Core)

- 2.** A and B are two events such that $p(A) = 0.3$, $p(B) = 0.5$ and $p(A \cup B) = 0.55$. Find the probability of the following events:
- (a) $A|B$ (b) $B|A$ (c) $A|B'$ (d) $A'|B'$
- 3.** Urn A contains 9 cubes of which 4 are red. Urn B contains 5 cubes of which 2 are red. A cube is drawn at random and in succession from each urn.
- (a) Draw a tree diagram representing this process.
(b) Find the probability that both cubes are red.
(c) Find the probability that only 1 cube is red.
(d) If only 1 cube is red, find the probability that it came from urn A.
- 4.** A box contains 5 red, 3 black, and 2 white cubes. A cube is randomly drawn and has its colour noted. The cube is then replaced, together with 2 more of the same colour. A second cube is then drawn.
- (a) Find the probability that the first cube selected is red.
(b) Find the probability that the second cube selected is black.
(c) Given that the first cube selected was red, what is the probability that the second cube selected is black?
- 5.** A fair coin, a double-headed coin and a double-tailed coin are placed in a bag. A coin is randomly selected. The coin is then tossed.
- (a) Draw a tree diagram showing the possible outcomes.
(b) Find the probability that the coin lands with a tail showing uppermost.
(c) In fact, the coin falls “heads”, find the probability that it is the “double-headed” coin.
- 6.** Two unbiased coins are tossed together. Find the probability that they both display heads given that at least one is showing a head.
- 7.** A money box contains 10 discs, 5 of which are yellow, 3 of which are black and 2 green. Two discs are selected in succession, with the first disc not replaced before the second is selected.
- (a) Draw a tree diagram representing this process.
(b) Hence find the probability that the discs will be of a different colour.
(c) Given that the second disc was black, what is the probability that both were black?
- 8.** Two dice are rolled. Find the probability that the faces are different given that the dice show a sum of 10.
- 9.** Given that $p(A) = 0.6$, $p(B) = 0.7$ and that A and B are independent events. Find the probability of the event
- (a) $A \cup B$ (b) $A \cap B$ (c) $A|B'$ (d) $A' \cap B$
- 10.** The probability that an animal will still be alive in 12 years is 0.55 and the probability that its mate will still be alive in 12 years is 0.60. Find the probability that
- (a) both will still be alive in 12 years.
(b) only the mate will still be alive in 12 years.
(c) at least one of them will still be alive in 12 years.
(d) the mate is still alive in 12 years given that only one is still alive in 12 years.

- 11.** Tony has a 90% chance of passing his maths test, whilst Tanya has an 85% chance of passing the same test. If they both sit for the test, find the probability that
- only one of them passes.
 - at least one passes the test.
 - Tanya passed given that at least one passed.
- 12.** The probability that Rory finishes a race is 0.55 and the probability that Millicent finishes the same race is 0.6. Because of team spirit, there is an 80% chance that Millicent will finish the race if Rory finishes the race. Find the probability that
- both will finish the race.
 - Rory finishes the race given that Millicent finishes.
- 13.** If A and B are independent events, show that their complementary events are also independent events.
- 14.** A student runs the 100 m, 200 m and 400 m races at the school athletics day. He has an 80% chance of winning any one given race. Find the probability that he will
- win all 3 races.
 - win the first and last race only.
 - win the second race given that he wins at least two races.
- 15.** Dale and Kritt are trying to solve a physics problem. The chances of solving the problem are Dale—65% and Kritt—75%. Find the probability that
- only Kritt solves the problem.
 - Kritt solves the problem.
 - both solve the problem.
 - Dale solves the problem given that the problem was solved.
- 16.** A coin which is weighted in such a way that there is a 70% chance of it landing heads. The coin is tossed three times in succession, find the probability of observing
- three tails.
 - two heads.
 - two heads given that at least one head showed up.

15.4 BAYES' THEOREM

15.4.1 LAW OF TOTAL PROBABILITY

Using the Venn diagram, for any event A , we have that

$$\begin{aligned} A &= A \cap \varepsilon = A \cap (B \cup B') \\ &= (A \cap B) \cup (A \cap B') \end{aligned}$$

As these two events are mutually exclusive, we have:

$$P(A) = P(A \cap B) + P(A \cap B')$$

However, $P(A|B) = \frac{P(A \cap B)}{P(B)} \Rightarrow P(A \cap B) = P(B) \times P(A|B)$

and $P(A|B') = \frac{P(A \cap B')}{P(B')} \Rightarrow P(A \cap B') = P(B') \times P(A|B')$.

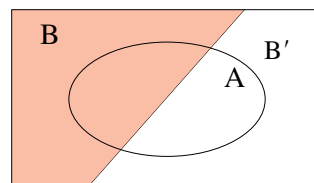

Which leads to the **Law of Total Probability**.

$$\therefore P(A) = P(B) \times P(A|B) + P(B') \times P(A|B')$$

Although this expression might look daunting, in fact, it represents the result that we would obtain if a tree diagram was used:

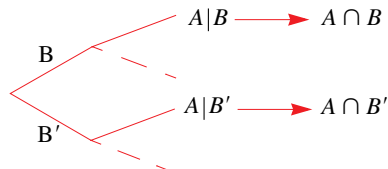

EXAMPLE 15.17

A box contains 3 black cubes and 7 white cubes. A cube is drawn from the box. Its colour noted and a cube of the other colour is then added to the box. A second cube is then drawn. What is the probability that the second cube selected is black?

S
o
l
u
t
i
o
n

We begin by setting up a tree diagram, where B_i denotes the event “A Black cube is observed on i th selection” and W_i denotes the event “A White cube is observed on i th selection”.

A black cube could have been observed on the second selection if

- i. the first cube selected was white (i.e., $B_2|W_1$), or
- ii. the first cube selected was black (i.e., $B_2|B_1$).

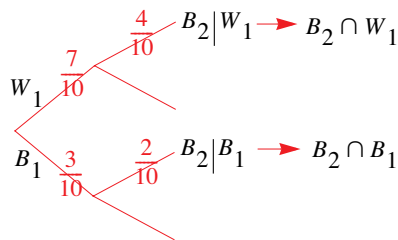

$$\text{Therefore, } P(B_2) = P(B_2 \cap W_1) + P(B_2 \cap B_1) = \frac{7}{10} \times \frac{4}{10} + \frac{3}{10} \times \frac{2}{10} = \frac{17}{50}.$$

15.4.2 BAYES' THEOREM FOR TWO EVENTS

As we saw earlier, conditional probability provides a mean by which we can adjust the probability of an event in light of new information. Bayes' Theorem, developed by Rev. Thomas Bayes (1702–1761), does the same thing, except this time it provides a means of adjusting a set of associated probabilities in the light of new information.

For two events, we have:

$$P(A|B) = \frac{P(A \cap B)}{P(B)} = \frac{P(A) \times P(B|A)}{P(A) \times P(B|A) + P(A') \times P(B|A')}$$

Again, the formula might seem daunting, however, it is only making use of a tree diagram.

EXAMPLE 15.18

A box contains 3 black cubes and 7 white cubes. A cube is drawn from the box. Its colour noted and a cube of the other colour is then added to the box. A second cube is then drawn. If both cubes are of the same colour, what is the probability that both cubes were in fact white?

S
o
l
u
t
i
o
n

Following on from the previous example, we have the same tree diagram:

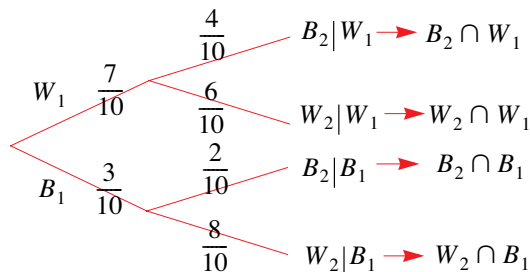

We require: $P(\text{Both White given that both are of the same colour})$

Now, the probability that they are of the same colour is given by the probability that they are **both white or both black**, i.e., $P((W_2 \cap W_1) \cup (B_2 \cap B_1))$.

Next: $P(\text{Both White given both are the same colour})$

$$\begin{aligned}
 &= P(W_2 \cap W_1 | (W_2 \cap W_1) \cup (B_2 \cap B_1)) \\
 &= \frac{P((W_2 \cap W_1) \cap ((W_2 \cap W_1) \cup (B_2 \cap B_1)))}{P((W_2 \cap W_1) \cup (B_2 \cap B_1))} \\
 &= \frac{P(W_2 \cap W_1)}{P(W_2 \cap W_1) + P(B_2 \cap B_1)} \\
 &= \frac{P(W_2|W_1) \times P(W_1)}{P(W_2|W_1)P(W_1) + P(B_2|B_1)P(B_1)} \\
 &= \frac{\frac{6}{10} \times \frac{7}{10}}{\frac{6}{10} \times \frac{7}{10} + \frac{2}{10} \times \frac{3}{10}} \\
 &= \frac{7}{8}
 \end{aligned}$$

EXAMPLE 15.19

In a small country town, it was found that 90% of the drivers would always wear their seatbelts. On 60% of occasions, if a driver was not wearing a seatbelt they would be fined for speeding. Whereas if they were wearing a seatbelt, they would be fined for speeding 20% of the time. Find the probability that a driver who was fined for speeding was wearing a seatbelt.

S
o
l
u
t
i
o
n

Let the event \$A\$ denote the event “driver wears a seatbelt” and \$B\$ denote the event “Driver speeds”. Using a tree diagram we have:

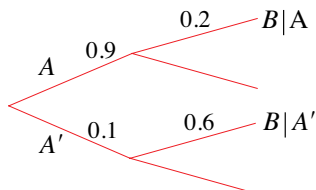

MATHEMATICS – Higher Level (Core)

We need to find, $Pr(\text{Driver was wearing a seatbelt} | \text{driver was booked for speeding})$

$$\begin{aligned} &= P(A|B) \\ &= \frac{P(A \cap B)}{P(B)} \\ &= \frac{P(A) \times P(B|A)}{P(A) \times P(B|A) + P(A') \times P(B|A')} \end{aligned}$$

$$\text{Therefore, } P(A|B) = \frac{0.9 \times 0.2}{0.9 \times 0.2 + 0.1 \times 0.6} = \frac{18}{24}$$

So, $P(\text{that a driver who was booked for speeding was in fact wearing a seatbelt}) = 0.75$

EXERCISES 15.4

- Two machines, A and B produce 40% and 60% of the daily output respectively. Each machine also produces a total of 3% and 5% respectively, of items that are defective.
 - An item is selected at random. Find the probability that it is defective.
 - An item is selected and is found to be defective. Find the probability that it came from machine B .
- At the Heights International School, it is found that 12% of the male students and 7% of the female students are taller than 1.8 m. Sixty percent of the school is made up of female students.
 - A student selected at random is found to be taller than 1.8m. What is the probability that the student is a female?
 - A second student selected at random is found to be shorter than 1.8m. What is the probability that the student is a male?
- A box contains 4 black cubes and 6 white cubes. A cube is drawn from the box. Its colour noted and a cube of the other colour is then added to the box. A second cube is then drawn.
 - If both cubes are of the same colour, what is the probability that both cubes were in fact white?
 - The first ball is replaced before the second ball is added to the box. What is the probability that both cubes were white given that both cubes were of the same colour?
- An urn, labelled A , contains 8 cards numbered 1 through 8 whilst a second urn, labelled B , contains five cards numbered 1 through five. An urn is selected at random and from that urn a card is selected. Find the probability that the card came from urn A given that it is an even numbered card.
- An event A can occur only if one of the mutually exclusive events B_1, B_2 or B_3 occurs. Show that
$$P(A) = P(B_1) \times P(A|B_1) + P(B_2) \times P(A|B_2) + P(B_3) \times P(A|B_3)$$
 - Of the daily output, machines A and B produce items of which 2% are defective, whilst machine C produces items of which 4% are defective. Machines B and C produce the same number of items, whilst machine A produces twice as many items as machine B .

- i. An item is selected at random. Find the probability that it is defective.
 - ii. An item is selected and is found to be defective. Find the probability that it came from machine B.
- 6.** A box contains N coins, of which m are fair coins whilst the rest are double-headed coins.
 - (a) A coin is selected at random and tossed.
 - i. What is the probability of observing a head?
 - ii. Given that a head was observed, what is the probability that the double-headed coin was selected?
 - (b) This time, a coin is selected at random and tossed n times. What is the probability that it was a fair coin, if it showed up heads on all n tosses?
- 7.** A population of mice is made up of 75% that are classified as 'M+', of which, 30% have a condition classified as 'N-'. Otherwise, all other mice have the 'N-' condition. A mouse selected at random is classified as having the 'N-' condition. What is the probability that the mouse comes from the 'M+' classification group?
- 8.** A survey of the adults in a town shows that 8% have liver problems. Of these, it is also found that 30% are heavy drinkers, 60% are social drinkers and 10% are non-drinkers. Of those that did not suffer from liver problems, 5% are heavy drinkers, 65% are social drinkers and 30% do not drink at all.
 - (a) An adult is selected at random. What is the probability that this person is a heavy drinker?
 - (b) If a person is found to be a heavy drinker, what is the probability that this person has liver problems?
 - (c) If a person is found to have liver problems, what is the probability that this person is a heavy drinker?
 - (d) If a person is found to be a non-drinker, what is the probability that this person has liver problems?
- 9.** The probability that a person has a deadly virus is 5 in one thousand. A test will correctly diagnose this disease 95% of the time and incorrectly on 20% of occasions.
 - (a) Find the probability of this test giving a correct diagnosis.
 - (b) Given that the test diagnoses the patient as having the disease, what is the probability that the patient does not have the disease?
 - (c) Given that the test diagnoses the patient as not having the disease, what is the probability that the patient does have the disease?
- 10.** The probability that a patient has a virus is 0.03. A medical diagnostic test will be able to determine whether the person in question actually has the virus. If the patient has the virus, the medical test will produce a positive result 90% of the time whilst if the patient does not have the virus, it will produce a negative result 98% of the time.
 - (a) What proportion of all tests provide a positive result?
 - (b) If the test shows a positive result, what is the probability that the patient actually has the virus?
 - (c) If the test shows a negative result, what is the probability that the patient does not have the virus?
- 11.** The probability that a day of the week will be dry or wet is related to the state of the previous day in the following manner:
 - If it is dry one day, the chances of it being dry the next is 0.8.
 - If it is wet one day, the chances of it being dry the next is 0.4

MATHEMATICS – Higher Level (Core)

- (a) Given that Monday is dry, what is the probability that Tuesday is wet?
 (b) Given that Monday is dry, what is the probability that Tuesday is wet and Wednesday is dry?
 (c) Given that Monday is dry, what is the probability that Wednesday is dry?

Define the conditional probability matrix, P_i , for $i = 1, 2, 3, \dots$, as follows:

$$P_i = \begin{bmatrix} p(\text{Day } i \text{ is dry} \mid \text{Day } i-1 \text{ is dry}) & p(\text{Day } i \text{ is wet} \mid \text{Day } i-1 \text{ is dry}) \\ p(\text{Day } i \text{ is dry} \mid \text{Day } i-1 \text{ is wet}) & p(\text{Day } i \text{ is wet} \mid \text{Day } i-1 \text{ is wet}) \end{bmatrix}$$

- (d) Find, P_1 and P_2 .
 (e) Verify that $P_2 = (P_1)^2$
 (f) Show that $P_{i+1} = P_i P_1$.
 (g) Use part f. to find the probability that Thursday will be dry, given that Monday was dry.

15.5 USING PERMUTATIONS AND COMBINATIONS IN PROBABILITY

Because enumeration is such an important part of finding probabilities, a sound knowledge of permutations and combinations can help to ease the workload involved.

EXAMPLE 15.20

Three maths books, three chemistry books and two physics books are to be arranged on a shelf. What is the probability that the three maths books are together?

S
o
l
u
t
i
o
n

The total number of arrangements of all 8 books is $8! = 40320$

To determine the number of arrangements that contain the three maths books together we make use of the box method:

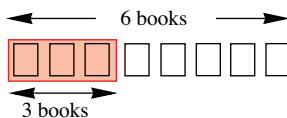

We now have 6 boxes to arrange, giving a total of $6!$ arrangements.

However, the three maths books (within the red box) can also be arranged in $3!$ ways.

Therefore, there are $6! \times 3! = 4320$ ways this can be done.

$$\begin{aligned} \text{So, } P(\text{maths books are together}) &= \frac{6! \times 3!}{8!} = \frac{6! \times 3!}{8 \times 7 \times 6!} = \frac{6}{8 \times 7} \\ &= \frac{3}{28} \end{aligned}$$

EXAMPLE 15.21

A committee of 5 is randomly chosen from 8 boys and 6 girls. Find the probability that the committee consists of at least 3 boys.

The possibilities are:

Boys	Girls	No. of Selections
3	2	$\binom{8}{3} \times \binom{6}{2} = 840$
4	1	$\binom{8}{4} \times \binom{6}{1} = 420$
5	0	$\binom{8}{5} \times \binom{6}{0} = 56$

The total number of committees with at least 3 boys is $840 + 420 + 56 = 1316$

However, the total number of committees of 5 from 14 is $\binom{14}{5} = 2002$.

If X denotes the number of boys on the committee, then $p(X \geq 3) = \frac{1316}{2002} = \frac{94}{143}$.

EXERCISES 15.5

- Five red cubes and 4 blue cubes are placed at random in a row. Find the probability that
 - the red cubes are together.
 - both end cubes are red.
 - the cubes alternate in colour.
- Five books of different heights are arranged in a row. Find the probability that
 - the tallest book is at the right end.
 - the tallest and shortest books occupy the end positions.
 - the tallest and shortest books are together.
 - the tallest and shortest books are never next to each other.
- Three cards are dealt from a pack of 52 playing cards. Find the probability that
 - 2 of the cards are kings.
 - all three cards are aces.
 - all three cards are aces given that at least one card is an ace.
- The letters of the word LOTTO are arranged in a row. What is the probability that the Ts are together?
- A committee of 4 is to be selected from 7 men and 6 women. Find the probability that
 - there are 2 women on the committee.
 - there is at least one of each sex on the committee.
- A basketball team of 5 is to be selected from 12 players. Find the probability that
 - the tallest player is selected.
 - the captain and vice-captain are selected.
 - either one, but not both of the captain or vice-captain are selected.
- Find the probability of selecting one orange, one apple and one pear from five oranges, four apples and three pears.

MATHEMATICS – Higher Level (Core)

- 8.** Three red cubes, four blue cubes and six yellow cubes are arranged in a row. Find the probability that
- the cubes at each end are the same colour.
 - the cubes at each end are of a different colour.
- 9.** A sample of three light bulbs is selected from a box containing 15 light bulbs. It is known that five of the light bulbs in the box are defective.
- Find the probability that the sample contains a defective.
 - Find the probability that the sample contains at least two defectives.
- 10.** Eight people of different heights are to be seated in a row. What is the probability that
- the tallest and shortest persons are sitting next to each other?
 - the tallest and shortest occupy the end positions?
 - there are at least three people sitting between the tallest and shortest?
- 11.** Eight people of different heights are to be seated in a row. The shortest and tallest in this group are not seated at either end. What is the probability that
- the tallest and shortest persons are sitting next to each other?
 - there is one person sitting between the tallest and shortest?
- 12.** A committee of four is to be selected from a group of five boys and three girls. Find the probability that the committee consists of exactly two girls given that it contains at least one girl.
- 13.** A bag contains 6 red marbles and 4 white marbles. Three marbles are randomly selected. Find the probability that
- all three marbles are red.
 - all three marbles are red given that at least two of the marbles are red.
- 14.** Four maths books, two chemistry books and three biology books are arranged in a row.
- What is the probability that the books are grouped together in their subjects?
 - What is the probability that the chemistry books are not grouped?
- 15.** A contestant on the game show “A Diamond for your Wife” gets to select 5 diamonds from a box. The box contains 20 diamonds of which 8 are fakes.
- Find the probability that the contestant will not bring a real diamond home for his wife.
- Regardless of how many real diamonds the contestant has after his selection, he can only take one home to his wife. A second contestant then gets to select from the remaining 15 diamonds in the box. But only gets to select one diamond.
- What is the probability that this second contestant selects a real diamond?
- 16.** Light bulbs are sold in packs of 10. A quality inspector selects two bulbs at random without replacement. If both bulbs are defective the pack is rejected. If neither are defective the pack is accepted. If one of the bulbs is defective the inspector selects two more from the bulbs remaining in the pack and rejects the pack if one or both are defective. What are the chances that a pack containing 4 defective bulbs will in fact be accepted?

16.1 DISCRETE RANDOM VARIABLES

16.1.1 CONCEPT OF A RANDOM VARIABLE

Consider the experiment of tossing a coin twice. The sample space, S , (i.e., the list of all possible outcomes) of this experiment can be written as $S = \{HH, HT, TH, TT\}$.

We can also assign a numerical value to these outcomes. For example, we can assign the number
 0 to the outcome $\{HH\}$,
 1 to the outcomes $\{HT, TH\}$ and
 2 to the outcome $\{TT\}$.

These numerical values are used to represent the number of times that a tail was observed **after** the coin was tossed.

The numbers 0, 1 and 2 are **random** in nature, that is, until the coins are tossed we have no idea as to which one of the outcomes will occur. We define a random variable as follows:

A **random variable**, X (random variables are usually denoted by capital letters), which can take on exactly n numerical values, each of which corresponds to one and only one of the events in the sample space is called a **discrete random variable**.

Note that the values that correspond to the random variables $X, Y, Z \dots$ are denoted by their corresponding lower case letters, $x, y, z \dots$. For the example above, $X = \{x: x = 0, x = 1, x = 2\}$.

16.1.2 DISCRETE RANDOM VARIABLE

A **discrete random** variable is one in which we can produce a **countable** number of outcomes. Because of this, discrete random variables are usually associated with a **counting process**. For example, the number of plants that will flower, the number of defective items in a box or the number of items purchased at a supermarket store.

We can display this concept using a simple diagram such as the one below:

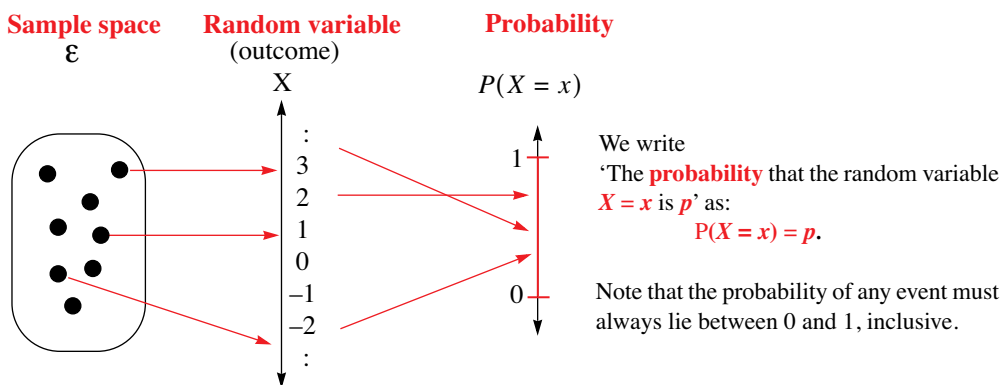

To obtain the sample space, we may need to carry out an experiment. However, as we shall see, there are many types of random variables that already possess their own sample spaces, random outcomes and associated probability values. We will deal with these later.

EXAMPLE 16.1

Consider the experiment of tossing a coin three times in succession.

- (a) List all possible outcomes.
- (b) If the random variable X denotes the number of heads observed, list the values that X can have and find the corresponding probability values.

**S
o
l
u
t
i
o
n**

(a) In the experiment of tossing a coin three times the sample space is given by
 $S = \{HHH, HHT, HTH, THH, TTH, THT, HTT, TTT\}$,
 where the event $\{HTH\}$ represents the observation, Head, Tail, Head in that order.

(b) This means that on any one trial of this experiment, we could have obtained either
 0 heads, 1 head, 2 heads or 3 heads.

Therefore, the random variable X has as its possible values the numbers 0, 1, 2, 3.

That is, $X = 0$ corresponds to the event $\{TTT\}$, that is, no heads.

$X = 1$ corresponds to the events $\{TTH, THT, HTT\}$, that is, one head.

$X = 2$ corresponds to the events $\{THH, HTH, HHT\}$, that is, two heads.

$X = 3$ corresponds to the event $\{HHH\}$, that is, three heads.

Once we have our sample space, we can look at the chances of each of the possible outcomes. In all there are 8 possible outcomes.

So that the chances of observing the event $\{HHH\}$ would be $\frac{1}{8}$, i.e., $P(X = 3) = \frac{1}{8}$.

To find $P(X = 2)$, we observe that the outcome ‘ $X = 2$ ’ corresponds to $\{THH, HTH, HHT\}$.

So that in this case there is a chance of 3 in 8 of observing the event where ‘ $X = 2$ ’.

Continuing in this manner we have

$$P(X = 0) = P(\{HHH\}) = \frac{1}{8}$$

$$P(X = 1) = P(\{TTH, THT, HTT\}) = \frac{3}{8}$$

$$P(X = 2) = P(\{HHT, HTH, THH\}) = \frac{3}{8}$$

$$P(X = 3) = P(\{HHH\}) = \frac{1}{8}$$

16.1.3 PROBABILITY DISTRIBUTIONS

We can describe a discrete random variable by making use of its probability distribution. That is, by showing the values of the random variable and the probabilities associated with each of its values.

A probability distribution can be displayed in any one of the following formats:

1. Tabular form

2. Graphical representation

(With the probability value on the vertical axis, and the values of the random variable on the horizontal axis.)

3. Function

(A formula that can be used to determine the probability values.)

EXAMPLE 16.2

Use each of the probability distribution representations discussed to display the results of the experiment where a coin is tossed three times in succession.

Solution

Let the random variable X denote the number of heads observed in three tosses of a coin.

1. Tabular form:

x	0	1	2	3
$p(X = x)$	$\frac{1}{8}$	$\frac{3}{8}$	$\frac{3}{8}$	$\frac{1}{8}$

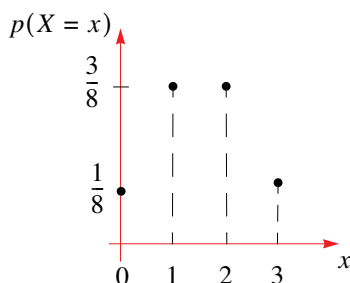
2. Graphical representation:

3. Function:

$$p(X = x) = \binom{3}{x} \left(\frac{1}{2}\right)^3, x = 0, 1, 2, 3, \text{ where } \binom{3}{x} = \frac{3!}{(3-x)!x!}.$$

16.1.4 PROPERTIES OF THE PROBABILITY FUNCTION

We can summarise the features of any discrete probability function as follows:

1. The probability for any value of X must **always lie between 0 and 1** (inclusive).

That is, $0 \leq P(X = x_i) \leq 1$ for all values of x_i .

2. For the n mutually exclusive and exhaustive events, A_1, A_2, \dots, A_n that make up the sample space \mathcal{E} , then, the sum of the corresponding probabilities must be 1.

That is,
$$\sum_{i=1}^{i=n} P(X = x_i) = P(X = x_1) + P(X = x_2) + \dots + P(X = x_n) = 1$$

Where $P(X = x_i)$ is the probability of event A_i occurring.

Any function that does not abide by these two rules cannot be a probability function.

EXAMPLE 16.3

Consider the random variable X with probability function defined by

$$P(X = 0) = \alpha, P(X = 1) = 2\alpha \text{ and } P(X = 2) = 3\alpha.$$

Determine the value of α .

Solution

Because we are given that this is a probability function, then summing all the probabilities must give a result of 1.

$$\begin{aligned} \text{Therefore we have that } P(X = 0) + P(X = 1) + P(X = 2) &= 1 \\ \therefore \alpha + 2\alpha + 3\alpha &= 1 \\ \Leftrightarrow 6\alpha &= 1 \\ \Leftrightarrow \alpha &= \frac{1}{6} \end{aligned}$$

EXAMPLE 16.4

The probability distribution of the random variable X is represented by the

function $P(X = x) = \frac{k}{x}, x = 1, 2, 3, 4, 5, 6$

Find (a) the value of k (b) $P(3 \leq X \leq 5)$.

Solution

(a) Using the fact that the sum of all the probabilities must be 1, we have

$$\begin{aligned} P(X = 1) + P(X = 2) + \dots + P(X = 6) &= \frac{k}{1} + \frac{k}{2} + \frac{k}{3} + \frac{k}{4} + \frac{k}{5} + \frac{k}{6} = 1 \\ \Leftrightarrow \frac{147k}{60} &= 1 \end{aligned}$$

Therefore, $k = \frac{60}{147} = \frac{20}{49}$.

(b) Now, $P(3 \leq X \leq 5) = P(X = 3) + P(X = 4) + P(X = 5) = \frac{k}{3} + \frac{k}{4} + \frac{k}{5} = \frac{47k}{60}$

However, we know that $k = \frac{60}{147}$.

Therefore, $P(3 \leq X \leq 5) = \frac{47}{60} \times \frac{60}{147} = \frac{47}{147}$.

EXAMPLE 16.5

A discrete random variable X has a probability distribution defined by the

function $P(X = x) = \binom{4}{x} \left(\frac{2}{5}\right)^x \left(\frac{3}{5}\right)^{4-x}$ where $x = 0, 1, 2, 3, 4$.

- (a) Display this distribution using i. a table form ii. a graphical form
 (b) Find i. $P(X = 2)$ ii. $P(1 \leq X \leq 3)$

Solution

(a) i. We begin by evaluating the probability for each value of x :

$$p(X = 0) = {}^4C_0 \left(\frac{2}{5}\right)^0 \left(\frac{3}{5}\right)^{4-0} = \frac{81}{625}, [\text{Using the notation } \binom{4}{x} = {}^4C_x].$$

$$p(X = 1) = {}^4C_1 \left(\frac{2}{5}\right)^1 \left(\frac{3}{5}\right)^3 = \frac{216}{625}, \quad p(X = 2) = {}^4C_2 \left(\frac{2}{5}\right)^2 \left(\frac{3}{5}\right)^2 = \frac{216}{625},$$

$$p(X = 3) = {}^4C_3 \left(\frac{2}{5}\right)^3 \left(\frac{3}{5}\right)^1 = \frac{96}{625}, \quad p(X = 4) = {}^4C_4 \left(\frac{2}{5}\right)^4 \left(\frac{3}{5}\right)^0 = \frac{16}{625}$$

We can now set up this information in a table:

x	0	1	2	3	4
$P(X = x)$	$\frac{81}{625}$	$\frac{216}{625}$	$\frac{216}{625}$	$\frac{96}{625}$	$\frac{16}{625}$

ii. Using the table found in part i., we can construct the following graph:

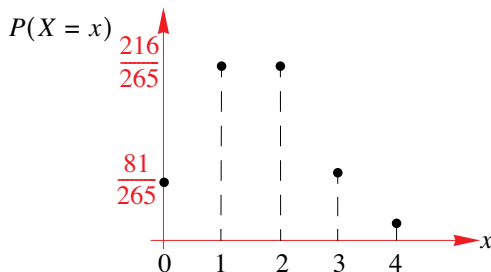

- (b) i. From our probability table, we have that $P(X = 2) = \frac{216}{625}$.
- ii. The statement $P(1 \leq X \leq 3)$ requires that we find the probability of the random variable X taking on the values 1, 2 or 3. This amounts to evaluating the sum of the corresponding probabilities.

$$\begin{aligned}
 \text{Therefore, we have } P(1 \leq X \leq 3) &= P(X = 1) + P(X = 2) + P(X = 3) \\
 &= \frac{216}{625} + \frac{216}{625} + \frac{96}{625} \\
 &= \frac{528}{625}
 \end{aligned}$$

16.1.5 CONSTRUCTING PROBABILITY FUNCTIONS

When we are given the probability distribution, we can determine the probabilities of events. However, there is still one issue that we must deal with:

How do we obtain the probabilities in the first place ?

Sometimes we recognise a particular problem and know of an existing model that can be used. However, resolving this question is not always an easy task, as this often requires the use of problem solving skills and modelling skills as well as interpretive skills.

EXAMPLE 16.6

A bag contains 5 white cubes and 4 red cubes. Two cubes are selected in such a way that the first cube drawn is not replaced before the next cube is drawn. Find the probability distribution of X , where X denotes the number of white cubes selected from the bag.

S
o
l
u
t
i
o
n

We start by drawing a diagram that will help us visualise the situation:

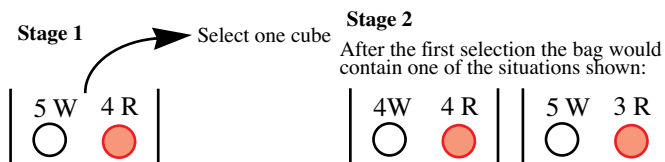

Next, we set up the corresponding tree diagram:

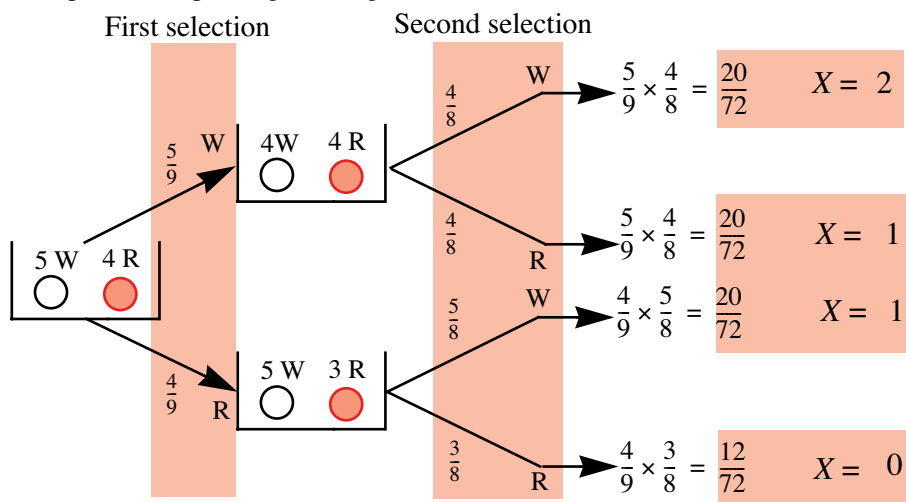

We are now in a position to complete the probability table.

x	0	1	2
$P(X = x)$	$\frac{12}{72}$	$\frac{40}{72}$	$\frac{20}{72}$

EXAMPLE 16.7

Two friends Kirsty and Bridget, independently applied for different jobs.

The chances that Kirsty is successful is 0.8 and the chances that Bridget is successful is 0.75.

- (a) If X denotes the number of successful applications between the two friends, find the probability distribution of X .
- (b) Hence find the probability that
- i. both are successful
 - ii. that if one is successful, it is Kirsty.

Solution

- a. Let K denote the event that Kirsty is successful, so that $P(K) = 0.8$ and let B denote the event that Bridget is successful, so that $P(B) = 0.75$.

Now, the event ' $X = 0$ ' translates to 'nobody is successful':

That is, $P(X = 0) = P(K' \cap B') = P(K') \times P(B') = 0.2 \times 0.25 = 0.05$.

Similarly, the event ' $X = 1$ ' translates to 'only one is successful':

That is, $P(X = 1) = P(K \cap B') + P(K' \cap B) = 0.8 \times 0.25 + 0.2 \times 0.75 = 0.35$.

Lastly, the event ' $X = 2$ ' translates to 'both are successful':

That is, $P(X = 2) = P(K \cap B) = P(K) \times P(B) = 0.8 \times 0.75 = 0.6$

We can now construct a probability distribution for the random variable X :

x	0	1	2
$P(X = x)$	0.05	0.35	0.60

- (b) i. $P(\text{Both successful}) = P(X = 2) = 0.60$
- ii. $P(K|\text{Only one is successful}) = \frac{P(K \cap \{X=1\})}{P(\{X=1\})} = \frac{P(K \cap B')}{P(\{X=1\})}$
 $= \frac{0.20}{0.35} (= 0.5714)$

EXERCISES 16.1

1. Find the value of k , so that the random variable X describes a probability distribution.

x	1	2	3	4	5
$P(X = x)$	0.25	0.20	0.15	k	0.10

2. The discrete random variable Y has the following probability distribution

y	1	2	3	4
$P(Y = y)$	β	2β	3β	4β

- (a) Find the value of β .
- (b) Find i. $P(Y = 2)$
 ii. $P(Y > 2)$
3. A delivery of six television sets contains 2 defective sets. A customer makes a random purchase of two sets from this delivery. The random variable X denotes the number of defective sets purchased by the customer.
- (a) Find the probability distribution table for X .
- (b) Represent this distribution as a graph.
- (c) Find $P(X \leq 1)$.
4. A pair of dice are rolled. Let Y denote the sum showing uppermost.
- (a) Determine the possible values that the random variable Y can have.
- (b) Display the probability distribution of Y in tabular form.
- (c) Find $P(Y = 8)$.
- (d) Sketch the probability distribution of Y .
5. A fair coin is tossed 3 times.
- (a) Draw a tree diagram representing this experiment.
- (b) Display this information using both graphical and tabular representations.
- (c) If the random variable Y denotes the number of heads that appear uppermost, find $P(Y \geq 2 | Y \geq 1)$.
6. The number of customers that enter a small corner newsagency between the hours of 8 p.m and 9 p.m can be modelled by a random variable X having a probability distribution given by $P(X = x) = k(3x + 1)$, where $x = 0, 1, 2, 3, 4$.
- (a) Find the value of k .

MATHEMATICS – Higher Level (Core)

- (b) Represent this distribution in
- tabular form.
 - graphical form.
- (c) What are the chances that at least 2 people will enter the newsagency between 8 p.m and 9 p.m on any one given day?

- 7.** The number of cars passing an intersection in the country during the hours of 4 p.m and 6 p.m follows a probability distribution that is modelled by the function

$$P(X = x) = \frac{(0.1)^x}{x!} e^{-0.1}, x = 0, 1, 2, 3, \dots$$

Where the random variable X denotes the number of cars that pass this intersection between 4 p.m and 6 p.m.

- (a) Find
- $P(X = 0)$
 - $P(X = 1)$
- (b) Find the probability of observing at least three cars passing through this intersection during the hours of 4 p.m and 6 p.m.
- 8.** The number of particles emitted during a one hour period is given by the random variable X , having a probability distribution

$$P(X = x) = \frac{(4)^x}{x!} e^{-4}, x = 0, 1, 2, 3, \dots, \text{ find } P(X > 4).$$

- 9.** A random variable X has the following probability distribution

x	0	1	2	3
$P(X = x)$	$\frac{1}{6}$	$\frac{1}{2}$	$\frac{1}{5}$	$\frac{2}{15}$

- (a) Find the probability distribution of $Y = X^2 - 2X$.
- (b) Find
- $P(Y = 0)$
 - $P(Y < 3)$.
- 10.** A bakery has six indistinguishable muffins on display. However, two of them have been filled with strawberry jam and the others with apricot jam. Claire, who hates strawberry jam, purchases two muffins at random. Let N denote the number of strawberry jam muffins Claire buys. Find the probability distribution of the random variable N .
- 11.** A box contains four balls numbered 1 to 4. A ball is selected at random from the box and its number is noted.

- (a) If the random variable X denotes the number on the ball, find the probability distribution of X .

After the ball is placed back into the box, a second ball is randomly selected.

- (b) If the random variable S denotes the sum of the numbers shown on the balls after the second draw, find the probability distribution of S .

- 12.** A probability distribution function for the random variable X is defined by

$$P(X = x) = k \times (0.9)^x, x = 0, 1, 2, \dots$$

- Find
- $P(X \geq 2)$.
 - $P(1 \leq X < 4)$

16.2 MEAN AND VARIANCE

16.2.1 CENTRAL TENDENCY AND EXPECTATION

For a discrete random variable X with a probability distribution defined by $P(X = x)$, we define the **expectation of the random variable X** as

$$\begin{aligned} E(X) &= \sum_{i=1}^{i=n} x_i P(X = x_i) \\ &= x_1 \times P(X = x_1) + x_2 \times P(X = x_2) + \dots + x_n \times P(X = x_n) \end{aligned}$$

Where $E(X)$ is read as “**The expected value of X** ”. $E(X)$ is interpreted as the **mean value** of X and is often written as μ_X (or simply μ). Often we write the expected value of X as

$\sum xP(X = x)$. This is in contrast to the **mode** which is the most common value(s) and the **median** which is the value with half the probabilities below and half above the median value.

16.2.2 SO WHAT EXACTLY DOES $E(X)$ MEASURE?

The expected value of the random variable is a **measure of the central tendency** of X . That is, it is an indication of its ‘central position’ – based not only on the values of X , but also the **probability weighting** associated with each value of X . That is, it is the probability-weighted average of its possible values.

To find the value of $E(X)$ using the formula $E(X) = \sum_{i=1}^{i=n} x_i P(X = x_i)$ we take each possible value of x_i , multiply it by its associated probability $P(X = x_i)$ (i.e., its ‘weight’) and then add the results. The number that we obtain can be interpreted in two ways:

1. As a **probability-weighted average**, it is a summary number that takes into account the relative probabilities of each x_i value.
2. As a **long-run average**, it is a measure of what one could expect to observe if the experiment was repeated a large number of times.
For example, when tossing a fair coin a large number of times (say 500 times) and the random variable X denotes the number of tails observed, we would expect to observe 250 tails, i.e., $E(X) = 250$.

Note: *Although we would expect 250 tails after tossing a coin 500 times, it might be that we do not observe this outcome! For example, if the average number of children per ‘family’ in Australia is 2.4, does this mean we expect to see 2.4 children per ‘family’?*

In short, we might not be able to observe the value $E(X)$ that we obtain.

EXAMPLE 16.8

For the random variable X with probability distribution defined by

x	1	2	3	4
$P(X = x)$	$\frac{1}{10}$	$\frac{2}{10}$	$\frac{3}{10}$	$\frac{4}{10}$

Find the mode, median and mean values of X .

S
o
l
u
t
i
o
n

The mode is $X = 4$ (the most probable) and the median 3 (half are above and half below 3—this is probably best done by sketching the cdf of X).

To find the mean of X we use the formula $E(X) = \sum_{i=1}^{i=n} x_i P(X = x_i)$:

$$\text{That is, } E(X) = \left(1 \times \frac{1}{10}\right) + \left(2 \times \frac{2}{10}\right) + \left(3 \times \frac{3}{10}\right) + \left(4 \times \frac{4}{10}\right) = \frac{1}{10} + \frac{4}{10} + \frac{9}{10} + \frac{16}{10} = 3$$

Therefore, X has a mean value of 3.

EXAMPLE 16.9

A fair die is rolled once. If the random variable X denotes the number showing, find the expected value of X .

S
o
l
u
t
i
o
n

Because the die is fair we have the following probability distribution:

x	1	2	3	4	5	6
$P(X = x)$	$\frac{1}{6}$	$\frac{1}{6}$	$\frac{1}{6}$	$\frac{1}{6}$	$\frac{1}{6}$	$\frac{1}{6}$

$$\begin{aligned} \text{Then, } E(X) &= \left(1 \times \frac{1}{6}\right) + \left(2 \times \frac{1}{6}\right) + \left(3 \times \frac{1}{6}\right) + \left(4 \times \frac{1}{6}\right) + \left(5 \times \frac{1}{6}\right) + \left(6 \times \frac{1}{6}\right) \\ &= \frac{21}{6} = 3.5 \end{aligned}$$

Notice then, that in the case above we obtain an expected value of 3.5, even though the random variable X does not actually take on the value 3.5! This is the same as when a census might report that the average number of children per family is 2.4, where clearly, there cannot be 2.4 children in any family.

Do not forget to use your graphics calculator for such tasks. To do so, enter the data as lists, then multiply the lists and add the results in the resulting list:

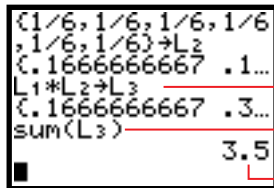
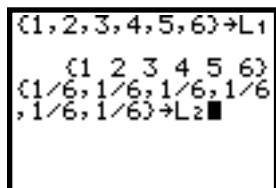

→ $xP(X = x)$ values
→ $\sum xP(X = x)$
→ Expected value

16.2.3 PROPERTIES OF THE EXPECTATION (FUNCTION)

1. $E(a) = a$, where a is a constant.

That is, the expected value of a constant is the constant itself.

2. $E(aX) = aE(X)$, where a is a constant.

3.
$$E(f(X)) = \sum_{i=1}^{i=n} f(x_i) \times P(X = x_i).$$

Where $f(X)$ is some real valued function of the random variable X .

4.
$$E(aX + b) = \sum_{i=1}^{i=n} (ax_i + b) \times P(X = x_i) = aE(X) + b$$
 where a and b are constants.

Note: This is a special case of 3., where in this case, $f(X) = aX + b$

NB: Be careful not to assume that $E(X^2)$ is the same as $(E(X))^2$, i.e., $E(X^2) \neq (E(X))^2$.

Nor does $E\left(\frac{1}{X}\right)$ equal $\frac{1}{E(X)}$, i.e., $E\left(\frac{1}{X}\right) \neq \frac{1}{E(X)}$.

In general, we have that $E(f(X)) \neq f(E(X))$ with $f(X) = aX + b$ being a notable exception.

EXAMPLE 16.10

For the probability distribution shown below

x	0	1	2	3
$P(X = x)$	$\frac{1}{6}$	$\frac{1}{2}$	$\frac{1}{5}$	$\frac{2}{15}$

Find (a) $E(X)$ (b) $E(X^2)$ (c) $E(X^2 + 3X - 1)$

(a) $E(X) = \sum xP(X = x) = 0 \times \frac{1}{6} + 1 \times \frac{1}{2} + 2 \times \frac{1}{5} + 3 \times \frac{2}{15} = 1.3$

(b) $E(X^2) = \sum x^2P(X = x) = 0^2 \times \frac{1}{6} + 1^2 \times \frac{1}{2} + 2^2 \times \frac{1}{5} + 3^2 \times \frac{2}{15} = 2.5$

Notice that $(E(X))^2 = (1.3)^2 = 1.69 \neq E(X^2)$!

(c) First we simplify the expression by ‘expanding’ and using some of the properties:

$$\begin{aligned} E(X^2 + 3X - 1) &= E(X^2) + E(3X) - E(1) \\ &= E(X^2) + 3E(X) - 1 \\ &= 2.5 + 3 \times 1.3 - 1 \\ &= 5.4 \end{aligned}$$

Again, making use of the graphics calculator can make the arithmetic in problems such as the one

MATHEMATICS – Higher Level (Core)

above much easier to deal with:

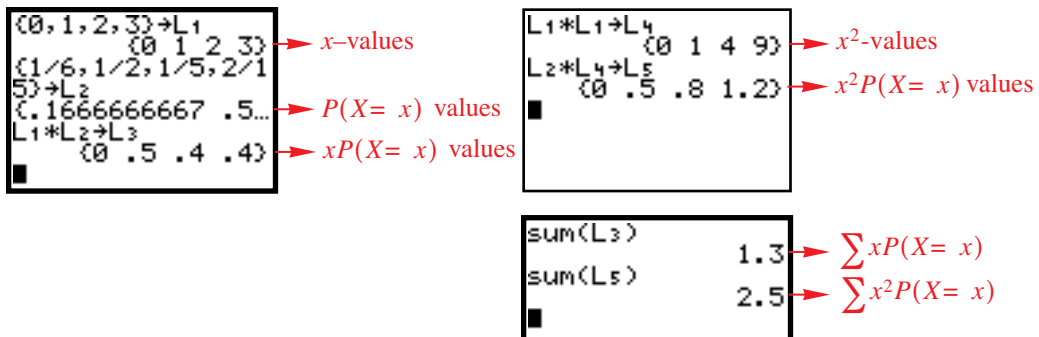

EXAMPLE 16.11

A dart board consisting of concentric circles of radius 1, 2 and 3 units is placed against a wall. Upon throwing a dart, which lands at some random location on the board, a player will receive \$8.00 if the smaller circle is hit, \$ 6.00 if the middle annular region is hit and \$ 4.00 if the outer annular region is hit. However, should the player miss the dart board altogether, they would lose \$ 7.00. The probability that the player misses the dart board altogether is 0.5.

- (a) How will the player fare in this game?
 (b) What can you say about this game?

Solution

- (a) Let X denote the player's "winnings" on any one throw. Therefore, $X = \{8, 6, 4, -7\}$. Notice that a loss of \$7.00 is represented by -7 . The probabilities corresponding to the random numbers in the set X can be determined by finding the proportion of area for each of the values.

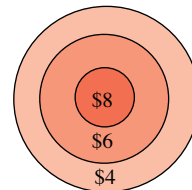

For example, to win \$8.00, the player must first hit the board, and then the dart must land in the inner circle (having a radius of 1 unit). Therefore, we have

$$P(X = 8) = \frac{1}{2} \times \frac{\pi \times 1^2}{\pi \times 3^2} = \frac{1}{18}.$$

Similarly,
$$P(X = 6) = \frac{1}{2} \times \frac{\pi \times 2^2 - \pi \times 1^2}{\pi \times 3^2} = \frac{1}{6},$$

$$P(X = 4) = \frac{1}{2} \times \frac{\pi \times 3^2 - \pi \times 2^2}{\pi \times 3^2} = \frac{5}{18}$$

and
$$P(X = -7) = 0.5$$

Therefore, we have that
$$E(X) = 8 \times \frac{1}{18} + 6 \times \frac{1}{6} + 4 \times \frac{5}{18} - 7 \times \frac{1}{2} = -\frac{17}{18} \approx -0.94.$$

That is, the player can expect to lose \$0.94 (this is considered as a long-run average loss).

- (b) Because $E(X) < 0$, the game is unfair. A fair game would have $E(X) = 0$.

16.2.4 VARIANCE

Although we now have a means by which we can calculate a measure of the central tendency of a random variable, an equally important aspect of a random variable is its spread. For example, the mean of the three numbers, 100, 110 and 120 is 110. Similarly, the mean of the three numbers 10, 100, and 220 is also 110. Yet clearly, the values in the second set of data have a wider spread than those in the first set of data. The **variance** (or more so, the **standard deviation**) provides a better measure of this spread.

The **variance** of a discrete random variable may be considered as the average of the squared deviations about the mean. This provides a measure of the variability of the random variable or the probability dispersion. The variance associated with the random variable X is given by

$$\text{Var}(X) = E((X - \mu)^2) = \sum_{i=1}^{i=n} (x - \mu)^2 P(X = x)$$

However, for computational purposes, it is often better to use the alternative definition:

$$\text{Var}(X) = E(X^2) - (E(X))^2 = E(X^2) - \mu^2$$

The variance is also denoted by σ^2 (read as “**sigma squared**”), i.e., $\text{Var}(X) = \sigma^2$.

We also have the **standard deviation**, given by

$$\text{Sd}(X) = \sigma = \sqrt{\text{Var}(X)},$$

which also provides a measure of the spread of the distribution of X .

What is the difference between the $\text{Var}(X)$ and the $\text{Sd}(X)$?

Because of the squared factor in the equation for $\text{Var}(X)$ (i.e., $\text{Var}(X) = E(X^2) - \mu^2$), the units of $\text{Var}(X)$ are not the same as those for X . However, because the $\text{Sd}(X)$ is the square root of the $\text{Var}(X)$, we have “adjusted” the units of $\text{Var}(X)$ so that they now have the same units as the random variable X .

The reason for using the $\text{Sd}(X)$ rather than the $\text{Var}(X)$ is that we can make clearer statistical statements about the random variable X (in particular, statements that relate to an overview of the distribution).

EXAMPLE 16.12

The probability distribution of the random variable X is shown below:

x	-2	-1	0	1	2
$P(X = x)$	$\frac{1}{64}$	$\frac{12}{64}$	$\frac{38}{64}$	$\frac{12}{64}$	$\frac{1}{64}$

Find (a) The variance of X . (b) The standard deviation of X .

S
o
l
u
t
i
o
n

(a) First we need to find $E(X)$ and $E(X^2)$:

$$E(X) = \sum xP(X = x) = -2 \times \frac{1}{64} + (-1) \times \frac{12}{64} + 0 \times \frac{38}{64} + 1 \times \frac{12}{64} + 2 \times \frac{1}{64} = 0$$

and $E(X^2) = \sum x^2P(X = x) = (-2)^2 \times \frac{1}{64} + (-1)^2 \times \frac{12}{64} + 0^2 \times \frac{38}{64} + 1^2 \times \frac{12}{64} + 2^2 \times \frac{1}{64} = \frac{1}{2}$

Therefore, $Var(X) = E(X^2) - \mu^2 = \frac{1}{2} - 0^2 = \frac{1}{2}$.

(b) Using $Sd(X) = \sigma = \sqrt{Var(X)}$, we have that, $Sd(X) = \sigma = \sqrt{\frac{1}{2}} \approx 0.707$.

16.2.5 PROPERTIES OF THE VARIANCE

1. If a is a constant, then $Var(a) = 0$.
That is, there is no variability in a constant!
2. $Var(aX) = a^2Var(X)$, where a is a constant.
3. $Var(aX + b) = a^2Var(X)$, where a and b are constants.

EXAMPLE 16.13

A random variable X has a probability distribution defined by

x	0	1	2	3	4
$P(X = x)$	$\frac{1}{16}$	$\frac{3}{16}$	$\frac{7}{16}$	$\frac{3}{16}$	$\frac{2}{16}$

Find (a) $E(X)$ (b) $Var(4X + 2)$ (c) $Sd(3 - X)$

S
o
l
u
t
i
o
n

(a) $E(X) = 0 \times \frac{1}{16} + 1 \times \frac{3}{16} + 2 \times \frac{7}{16} + 3 \times \frac{3}{16} + 4 \times \frac{2}{16} = \frac{17}{8}$

(b) To evaluate $Var(4X + 2)$, we need $E(X^2)$:

Now, $E(X^2) = 0^2 \times \frac{1}{16} + 1^2 \times \frac{3}{16} + 2^2 \times \frac{7}{16} + 3^2 \times \frac{3}{16} + 4^2 \times \frac{2}{16} = \frac{45}{8}$

Therefore, $Var(4X + 2) = 4^2Var(X) = 16\left(\frac{45}{8} - \left(\frac{17}{8}\right)^2\right) = 16 \times \frac{71}{64} = \frac{71}{4}$.

(c) $Sd(3 - X) = \sqrt{Var(3 - X)}$

However, $Var(3 - X) = (-1)^2Var(X) = \frac{71}{64} \therefore Sd(3 - X) = \sqrt{\frac{71}{64}} \approx 1.05$.

EXERCISES 16.2

1. A discrete random variable X has a probability distribution given by.

x	1	2	3	4	5
$P(X = x)$	0.25	0.20	0.15	0.3	0.10

- (a) Find the mean value of X .
 (b) Find the variance of X .

2. The discrete random variable Y has the following probability distribution

y	1	2	3	4
$P(Y = y)$	0.1	0.2	0.3	0.4

- (a) Find the mean value of Y .
 (b) Find i. $Var(Y)$ ii. $Sd(Y)$
 (c) Find i. $E(2Y)$ ii. $E\left(\frac{1}{Y}\right)$

3. A random variable X has the following probability distribution

x	0	1	2	3
$P(X = x)$	$\frac{1}{6}$	$\frac{1}{2}$	$\frac{1}{5}$	$\frac{2}{15}$

- (a) Find i. $E(X)$ ii. $E(X^2)$ iii. $E(X^2 - 2X)$.
 (b) Find i. $Sd(X)$ ii. $Var(3X + 1)$
 (c) If $Y = \frac{1}{X+1}$, find
 i. $E(Y)$ ii. $E(Y^2)$

4. A delivery of six television sets contains 2 defective sets. A customer makes a random purchase of two sets from this delivery. The random variable X denotes the number of defective sets the customer purchased. Find the mean and variance of X .

5. A pair of dice are rolled. Let Y denote the sum showing uppermost.

- (a) Find $E(Y)$
 (b) Find $Var(Y)$

6. How many tails would you expect to observe when a fair coin is tossed 3 times.

7. The number of customers that enter a small corner newsagency between the hours of 8 p.m and 9 p.m can be modelled by a random variable X having a probability distribution given by $P(X = x) = k(2x + 1)$, where $x = 0, 1, 2, 3, 4$.

MATHEMATICS – Higher Level (Core)

- (a) Find the value of k .
 (b) How many customers can be expected to enter the newsagency between 8 and 9 p.m?
 (c) Find the standard deviation of X .

- 8.** A discrete random variable Y has its probability distribution function defined as

y	-2	-1	0	1
$P(Y = y)$	k	0.2	$3k$	0.4

- (a) Find k .
 (b) Given that the function, F , is defined by $F(y) = P(Y \leq y)$, find
 i. $F(-1)$ ii. $F(1)$
 (c) Find
 i. the expected value of Y
 ii. the variance of Y
 iii. the expected value of $(Y + 1)^2$
- 9.** A dart board consisting of consecutive circles of radius 1, 2 and 3 units is placed against a wall. A player throws darts at the board, each dart landing at some random location on the board. The player will receive \$9.00 if the smaller circle is hit, \$7.00 if the middle annular region is hit and \$4.00 if the outer annular region is hit. Should players miss the board altogether, they would lose \$ k each time. The probability that the player misses the dart board is 0.5. Find the value of k if the game is to be fair.
- 10.** A box contains 7 black cubes and 3 red cubes. Debra selects three cubes from the box without replacement. Let the random variable N denote the number of red cubes selected by Debra.
 (a) Find the probability distribution for N .
 (b) Find i. $E(N)$ ii. $Var(N)$.
 Debra will win \$2.00 for every red cube selected and lose \$1.00 for every black cube selected. Let the random variable W denote Debra's winnings.
 (c) If $W = aN + b$, find a and b . Hence, find $E(W)$.
- 11.** (a) A new gambling game has been introduced in a casino:
 A player stakes \$8.00 in return for the throw of two dice, where the player wins as many dollars as the sum of the two numbers showing uppermost.
 How much money can the player expect to walk away with?
 (b) At a second casino, a different gambling game has been set up:
 A player stakes \$8.00 in return for the throw of two dice, if two sixes come up, the player wins \$252.
 Which game would be more profitable for the casino in the long run?

- 12.** Given that $Var(X) = 2$, find

(a) $Var(5X)$ (b) $Var(-3X)$ (c) $Var(1 - X)$

- 13.** Given that $Var(X) = 3$ and $\mu = 2$, find

(a) $E(2X^2 - 4X + 5)$ (b) $Sd\left(4 - \frac{1}{3}X\right)$ (c) $E(X^2) + 1 - E((X + 1)^2)$

- 14.** A store has eight toasters left in its storeroom. Three of the toasters are defective and should not be sold. A salesperson, unaware of the defective toasters, selects two toasters for a customer. Let the random variable N denote the number of defective toasters the customer purchases. Find

- (a) $E(N)$.
 (b) $Sd(N)$.

- 15.** (a) The random variable Y is defined by:

y	-1	1
$P(Y = y)$	p	$1 - p$

Find the mean and variance of Y .

- (b) The random variable X is defined as $X = Y_1 + Y_2 + Y_3 + \dots + Y_n$ where each $Y_i, i = 1, 2, 3, \dots, n$ is independent and has the distribution defined in (a).

- Find i. $E(X)$
 ii. $Var(X)$

- 16.** A game is played by selecting coloured discs from a box. The box initially contains two red and eight blue discs. Tom pays \$10.00 to participate in the game. Each time Tom participates he selects two discs. The winnings are governed by the probability distribution shown below, where the random variable N is the number of red discs selected.

n	0	1	2
Winnings	\$0	\$W	\$5W
$P(N = n)$			

- (a) Complete the table.
 (b) For what value of W will the game be fair?

- 17.** A random variable X has the following probability distribution:

x	0	1	2
$P(X = x)$	a	$\frac{1}{3}(1 - b)$	$\frac{1}{3}b$

- (a) What values may a and b take?
 (b) Express, in terms of a and b i. $E(X)$ ii. $Var(X)$

- 18.** (a) Find the mean and variance of the probability distribution defined by

$$P(Z = z) = k(0.8)^z, z = 0, 1, 2, \dots$$

- (b) i. Show $P(X = x) = p \times (1 - p)^x, x = 0, 1, 2, \dots$ defines a probability distribution.
 ii. Show that $E(X) = \frac{1-p}{p}$
 iii. Show that $Var(X) = \frac{1-p}{p^2}$.

16.3 THE BINOMIAL DISTRIBUTION

16.3.1 THE BINOMIAL EXPERIMENT

The binomial distribution is a special type of discrete distribution which finds applications in many settings of everyday life. In this section we summarise the important features of this probability distribution.

16.3.2 BERNOULLI TRIALS

Certain experiments consist of repeated trials where each trial has only two mutually exclusive, possible outcomes. Such trials are referred to as **Bernoulli trials**. The outcomes of a Bernoulli trial are often referred to as “a success” or “a failure”. The terms “success” and “failure” in this context do not necessarily refer to the everyday usage of the word success and failure. For example, a “success” could very well be referring to the outcome of selecting a defective transistor from a large batch of transistors.

We often denote $P(\text{Success})$ by p and $P(\text{Failure})$ by q , where $p + q = 1$ (or $q = 1 - p$).

16.3.3 PROPERTIES OF THE BINOMIAL EXPERIMENT

1. There are a fixed number of trials. We usually say that there are n trials.
2. On each one of the n trials there is only one of two possible outcomes, labelled “*success*” and “*failure*”.
3. Each trial is identical and independent.
4. On each of the trials, the probability of a success, p , is always the same, and the probability of a failure, $q = 1 - p$, is also always the same.

16.3.4 THE BINOMIAL DISTRIBUTION

If a (discrete) random variable X has all of the above mentioned properties, we say that X has a **binomial distribution**. The probability distribution function is given by

$$p(X = x) = \binom{n}{x} p^x q^{n-x} = \binom{n}{x} p^x (1-p)^{n-x}, x = 0, 1, 2, \dots, n$$

Where X denotes the **number of successes** in n trials such that the **probability of a success on any one trial** is p , $0 \leq p \leq 1$ and $p + q = 1$ (or $q = 1 - p$).

We can also express the binomial distribution in a compact form, written as $X \sim B(n, p)$, read as “ **X is distributed binomially with parameters n and p** ”, where n is the number of trials and $p = P(\text{success})$ [it is also common to use $X \sim \text{Bin}(n, p)$].

For example, the probability function for $X \sim B(6, 0.4)$ (i.e., 6 trials and $p = 0.4$) would be

$$P(X = x) = \binom{6}{x} (0.4)^x (0.6)^{6-x}, x = 0, 1, 2, \dots, n.$$

EXAMPLE 16.14

If $X \sim B(5, 0.6)$, find $P(X = 4)$.

S
o
l
u
t
i
o
n

$X \sim B(5, 0.6)$ means that $P(X = 4)$ is the probability of 4 successes in five trials, where each trial has a 0.6 chance of being a success, that is, $n = 5, p = 0.6$ and $x = 4$.

$$\begin{aligned} \therefore P(X = 4) &= {}^5C_4(0.6)^4(0.4)^{5-4} \\ &= \frac{5!}{1!4!}(0.6)^4(0.4)^1 \\ &= 0.2592 \end{aligned}$$



Again we see how useful the TI-83 is when dealing with probability. In particular, when dealing with known distributions.

Pressing **2nd VARS** brings up the **DIST** menu. From this menu we can then scroll down to the appropriate distribution and then, after we enter the appropriate parameters, we obtain the required probability.

When dealing with the binomial distribution there are two options:

1. the **binompdf** function – which evaluates individual probabilities and
2. the **binomcdf** function – which evaluates cumulative probabilities.

EXAMPLE 16.15

A manufacturer finds that 30% of the items produced from one of the assembly lines are defective. During a floor inspection, the manufacturer selects 6 items from this assembly line. Find the probability that the manufacturer finds

- (a) two defectives. (b) at least two defectives.

S
o
l
u
t
i
o
n

- (a) Let X denote the number of defectives in the sample of six. Therefore, we have that $n = 6, p(\text{success}) = p = 0.30$ ($\Rightarrow q = 1 - p = 0.70$), so that $X \sim B(6, 0.3)$.

Note that in this case, a ‘success’ refers to a defective.

i. $P(X = 2) = {}^6C_2(0.3)^2(0.7)^4 = 0.3241$.

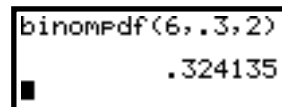

ii.
$$P(X \geq 2) = P(X = 2) + P(X = 3) + \dots + P(X = 6)$$

$$= {}^6C_2(0.3)^2(0.7)^4 + {}^6C_3(0.3)^3(0.7)^3 + \dots + {}^6C_6(0.3)^6(0.7)^0$$

Evaluating the probabilities manually is rather time consuming as there are lots of calculations. However the TI-83 can provide a list of the individual probability values. We can then scroll across the screen to see the other values:

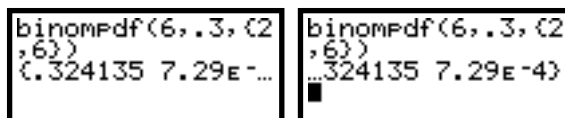

MATHEMATICS – Higher Level (Core)

A second method makes use of the complementary event:

$$\begin{aligned}
 P(X \geq 2) &= 1 - P(X < 2) = 1 - P(X \leq 1) \\
 &= 1 - [P(X = 1) + P(X = 0)] \\
 &= 1 - [0.1176 + 0.3025] \\
 &= 0.5798
 \end{aligned}$$

```

1-binomcdf(6,.3,
1)
.579825
    
```

Note: Using the cumulative binomial distribution on the TI-83, we have that

$$P(X \geq 2) = 1 - P(X \leq 1) = 1 - \mathbf{binomcdf}(6,0.3,1) = 1 - 0.420175 = 0.5798$$

EXAMPLE 16.16

Sophie has 10 pots labelled one to ten. Each pot, and its contents, is identical in every way. Sophie plants a seed in each pot such that each seed has a germinating probability of 0.8.

- (a) What is the probability that all the seeds will germinate?
- (b) What is the probability that only three seeds will not germinate?
- (c) What is the probability that more than eight seeds do germinate?
- (d) How many pots must Sophie use to be 99.99% sure that at least one seed germinates?

Solution

Let X denote the number of seeds germinating. Therefore we have that $X \sim B(10, 0.8)$, i.e., X is binomially distributed with parameters $n = 10$ and $p = 0.8$ (and $q = 1 - p = 0.2$)

- (a) $P(X = 10) = \binom{10}{10}(0.8)^{10}(0.2)^0 = 0.1074$.
- (b) If only three seeds will **not** germinate, then only seven seeds must germinate!

We want, $P(X = 7) = \binom{10}{7}(0.8)^7(0.2)^3 = 0.2013$.

```

binompdf(10,.8,1
0)
.1073741824
binompdf(10,.8,7
)
.201326592
    
```

- (c) Now, $P(X > 8) = P(X = 9) + P(X = 10)$
 $= 0.2684 + 0.1074$
 $= 0.3758$

```

binompdf(10,.8,(
9,10)
.268435456 .10...
binompdf(10,.8,(
9,10)
...456 .107374182...
    
```

- (d) At least one flower means, $X \geq 1$, therefore we need to find a value of n such that $P(X \geq 1) \geq 0.9999$.

Now, $P(X \geq 1) = 1 - P(X = 0) = 1 - \binom{n}{0}(0.8)^0(0.2)^n = 1 - (0.2)^n$.

Solving for n we have: $1 - (0.2)^n \geq 0.9999 \Leftrightarrow (0.2)^n \leq 0.0001$

This inequality can be solved by trial and error, algebraically, or as we will solve it, graphically:

Enter relevant equations

```

Plot1 Plot2 Plot3
\Y1= (.2)^X
\Y2=.0001
\Y3=
\Y4=
\Y5=
\Y6=
\Y7=
    
```

Set domain and range

```

WINDOW
Xmin=-1
Xmax=8
Xscl=1
Ymin=0
Ymax=.00015
Yscl=.25
Xres=1
    
```

Sketch graph

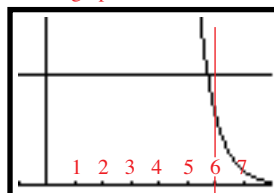

From the graph we see that for $(0.2)^n \leq 0.0001$, Sophie would need at least 6 pots, i.e., $n \geq 6$.

16.3.5 EXPECTATION, MODE AND VARIANCE FOR THE BINOMIAL DISTRIBUTION

If the random variable X , is such that $X \sim B(n, p)$, we have;

1. the **expected value of X** is $\mu = E(X) = np$
2. the **mode of X** is that value of x which has the largest probability
3. the **variance of X** is $\sigma^2 = Var(X) = npq = np(1 - p)$.

- Note
1. Although we can use our earlier definitions of the expected value and the variance of a random variable, the formulas above are a nice compact form and can only be used when dealing with the binomial distribution
 2. The standard deviation, $Sd(X)$, is still given by $\sigma = \sqrt{Var(X)} = \sqrt{npq}$.

EXAMPLE 16.17

A fair die is rolled six times. If X denotes the number of fours obtained, find

- (a) $E(X)$. (b) the mode of X . (c) $Sd(X)$.

S
o
l
u
t
i
o
n

In this case we have that $X \sim B\left(6, \frac{1}{6}\right)$, therefore $q = \frac{5}{6}$.

- (a) $\mu = E(X) = 6 \times \frac{1}{6} = 1$.
- (b) To find the mode, we need to know the probability of each outcome. We do this by constructing a table of values:

x	0	1	2	3	4	5	6
$P(X = x)$	$\frac{15625}{46656}$	$\frac{18750}{46656}$	$\frac{9375}{46656}$	$\frac{2500}{46656}$	$\frac{375}{46656}$	$\frac{30}{46656}$	$\frac{1}{46656}$

So that the mode of X is 1 (as it has the highest probability value).

Notice that in this case, the mode of $X =$ expected value of X .

Will this always be the case?

- (c) $\sigma = \sqrt{Var(X)} = \sqrt{npq} = \sqrt{6 \times \frac{1}{6} \times \frac{5}{6}} \approx 0.9129$.

EXAMPLE 16.18

An urn contains 7 marbles of which 2 are blue. A marble is selected, its colour noted and then replaced in the urn. This process is carried out 50 times. Find;

- (a) The mean number of blue marbles selected.
 (b) The standard deviation of the number of blue marbles selected.

Because we replace the marble before the next selection, each trial is identical and independent. Therefore, if we let X denote the number of blue marbles selected, we have

that $p = \frac{2}{7}$, $n = 50$ and $q = \frac{5}{7}$.

(a) $E(X) = np = 50 \times \frac{2}{7} = 14.29$

(b) $Var(X) = npq = 50 \times \frac{2}{7} \times \frac{5}{7} = \frac{500}{49} \therefore \sigma = \sqrt{\frac{500}{49}} \approx 3.19$.

EXAMPLE 16.19

The random variable X is such that $E(X) = 8$ and $Var(X) = 4.8$.

Find $p(X = 3)$.

This time we are given that $np = 8$ and $npq = np(1 - p) = 4.8$.

Therefore, after substituting $np = 8$ into $np(1 - p) = 4.8$, we have that

$$8(1 - p) = 4.8$$

$$\therefore (1 - p) = 0.6 \Rightarrow p = 0.4$$

Substituting $p = 0.4$ back into $np = 8$, we have that $n = 20$.

Therefore, $P(X = 3) = \binom{20}{3} (0.4)^3 (0.6)^{17} = 0.0123$.

EXERCISES 16.3

1. At an election 40% of the voters favoured the Environment Party. Eight voters were interviewed at random. Find the probability that
 - (a) exactly 4 voters favoured the Environment Party.
 - (b) a majority of those interviewed favoured the Environment Party.
 - (c) at most 3 of the people interviewed favoured the Environment Party.

2. In the long run, Thomas wins 2 out of every 3 games. If Thomas plays 5 games, find the probability that he will win
 - (a) exactly 4 games.
 - (b) at most 4 games.
 - (c) no more than 2 games.
 - (d) all 5 games.

3. A bag consists of 6 white cubes and 10 black cubes. Cubes are withdrawn one at a time with replacement. Find the probability that after 4 draws
 - (a) all the cubes are black.
 - (b) there are at least 2 white cubes.
 - (c) there are at least 2 white cubes given that there was at least one white cube.

- 4.** An X-ray has a probability of 0.95 of showing a fracture in the leg. If 5 different X-rays are taken of a particular leg, find the probability that
- all five X-rays identify the fracture.
 - the fracture does not show up.
 - at least 3 X-rays show the fracture
 - only one X-ray shows the fracture.
- 5.** A biased die, in which the probability of a '2' turning up is 0.4, is rolled 8 times. Find the probability that:
- a '2' turns up 3 times.
 - a '2' turns up on at least 4 occasions.
- 6.** During an election campaign, 66% of a population of voters are in favour of a food quality control proposal. A sample of 7 voters was chosen at random from this population. Find the probability that:
- there will be 4 voters that were in favour.
 - there will be at least 2 voters who were in favour.
- 7.** During an election 35% of the people in a town favoured the fishing restrictions at Lake Watanaki. Eight people were randomly selected from the town. Find the probability that:
- 3 people favoured fishing restrictions.
 - at most 3 of the eight favoured fishing restrictions.
 - there was a majority in favour of fishing restrictions.
- 8.** A bag containing 3 white balls and 5 black balls has 4 balls withdrawn one at a time, in such a way that the first ball is replaced before the next one is drawn. Find the probability
- of selecting 3 white balls.
 - of selecting at most 2 white balls.
 - of selecting a white ball, two black balls and a white ball in that order.
 - of selecting two white balls and two black balls.
- 9.** A tennis player finds that he wins 3 out of 7 games he plays. If he plays 7 games straight, find the probability that he will win
- exactly 3 games.
 - at most 3 games.
 - all 7 games.
 - no more than 5 games.
 - After playing 30 games, how many of these would he expect to win?
- 10.** A true–false test consists of 8 questions. A student will sit for the test, but will only be able to guess at each of the answers. Find the probability that the student answers
- all 8 questions correctly.
 - 4 questions correctly.
 - at most 4 of the questions correctly.
- The following week, the same student will sit another true–false test, this time there will be 12 questions on the test, of which he knows the answer to 4.
- What are the chances of passing this test (assuming that 50% is a pass.)
- 11.** The births of males and females are assumed to be equally likely, find the probability that in a family of 6 children:
- there are exactly 3 girls.
 - there are no girls.

MATHEMATICS – Higher Level (Core)

- (c) the girls are in the majority.
(d) How many girls would you expect to see in a family of 6 children?

12. During any one production cycle it is found that 12% of items produced by a manufacturer are defective. A sample of 10 items are selected at random and inspected. Find the probability that:

- (a) no defectives will be found.
(b) at least two defectives will be found.

A batch of 1000 such items are now inspected.

- (c) How many of these items would you expect to be defective?

13. 10% of washers produced by a machine are considered to be either oversized or undersized. A sample of 8 washers is randomly selected for inspection.

- (a) What is the probability that there are 3 defective washers?
(b) What is the probability that there is at least one defective washer?

14. Over a long period of time, an archer finds that she is successful on 90% of her attempts. In the final round of a competition she has 8 attempts at a target.

- (a) Find the probability that she is successful on all 8 attempts.
(b) Find the probability that she is successful on at least 6 attempts.

The prize that is awarded is directly proportional to the number of times she is successful, earning 100 fold, in dollars, the number of times she is successful.

- (c) What can she expect her winnings to be after one round?

She draws with another competitor, however, as there can be only one winner, a second challenge is put into place:

They must participate in another 3 rounds, with 5 attempts in each round.

- (d) Find the probability that she manages 3 perfect rounds.

15. For each of the random variables, (a) $X \sim B(7, 0.2)$

(b) $X \sim B(8, 0.38)$

- Find
- the mean,
 - the mode and
 - the standard deviation
 - $P(X \geq 6 | X > 4)$
 - $P(X > 4 | X \leq 6)$

16. In a suburb, it is known that 40% of the population are blue collar workers. A delegation of one hundred volunteers are each asked to sample 10 people in order to determine if they are blue collar workers. The town has been broken up into 100 regions so that there is no possibility of doubling up (i.e., each worker is allocated one region). How many of these volunteers would you expect to report that there were fewer than 4 blue collar workers.

17. Show that if $X \sim B(n, p)$, then

$$P(X = x + 1) = \left(\frac{n-x}{x+1}\right) \left(\frac{p}{1-p}\right) P(X = x), \quad x = 0, 1, 2, \dots, n-1$$

18. Show that if $X \sim B(n, p)$, then

- (a) $E(X) = np$. (b) $Var(X) = np(1-p)$.

- 19.** Mifumi has ten pots labelled one to ten. Each pot and its content can be considered to be identical in every way. Mifumi plants a seed in each pot, such that each seed has a germinating probability of 0.8.
- (a) Find the probability that
 - i. all the seeds will germinate.
 - ii. exactly three seeds will germinate.
 - iii. more than eight seeds germinate.
 - (b) How many pots must Mifumi use to be 99.99% sure to obtain at least one flower?
- 20.** A fair die is rolled eight times. If the random variable X denotes the number of fives observed, find
- (a) $E(X)$
 - (b) $Var(X)$
 - (c) $E\left(\frac{1}{8}X\right)$
 - (d) $Var\left(\frac{1}{8}X\right)$
- 21.** A bag contains 5 balls of which 2 are red. A ball is selected at random. Its colour noted and then replaced in the bag. This process is carried out 50 times. Find
- (a) the mean number of red balls selected.
 - (b) the standard deviation of the number of red balls selected.
- 22.** The random variable X is $B(n, p)$ distributed such that $\mu = 9$ and $\sigma^2 = 3.6$. Find
- (a) $E(X^2 + 2X)$
 - (b) $P(X = 2)$
- 23.**
- (a) If $X \sim Bin(10, 0.6)$, find
 - i. $E(X)$
 - ii. $Var(X)$
 - (b) If $X \sim Bin(15, 0.4)$, find
 - i. $E(X)$
 - ii. $Var(X)$
- 24.** The random variable X has a binomial distribution such that $E(X) = 12$ and $Var(X) = 4.8$. Find $P(X = 12)$.
- 25.** Metallic parts produced by an automated machine have some variation in their size. If the size exceeds a set threshold, the part is labelled as defective. The probability that a part is defective is 0.08. A random sample of 20 parts is taken from the day's production. If X denotes the number of defective parts in the sample, find its mean and variance.
- 26.** Quality control for the manufacturing of bolts is carried out by taking a random sample of 15 bolts from a batch of 10,000. Empirical data shows that 10% of bolts are found to be defective. If three or more defectives are found in the sample, that particular batch is rejected.
- (a) Find the probability that a batch is rejected.
 - (b) The cost to process the batch of 10,000 bolts is \$20.00. Each batch is then sold for \$38.00, or it is sold as scrap for \$5.00 if the batch is rejected. Find the expected profit per batch.
- 27.** In a shooting competition, a competitor knows (that on average) she will hit the bullseye on three out of every five attempts. If the competitor hits the bullseye she receives \$10.00. However if the competitor misses the bullseye but still hits the target region she only receives \$5.00.
- (a) What can the competitor expect in winnings on any one attempt at the target?
 - (b) How much can the competitor expect to win after 20 attempts?

MATHEMATICS – Higher Level (Core)

28. A company manufactures bolts which are packed in batches of 10,000. The manufacturer operates a simple sampling scheme whereby a random sample of 10 is taken from each batch. If the manufacturer finds that there are fewer than 3 faulty bolts the batch is allowed to be shipped out. Otherwise, the whole batch is rejected and re-processed.

(a) If 10% of all bolts produced are known to be defective, find the proportion of batches that will be re-processed.

(b) Show that if $100p\%$ of bolts are known to be defective, then

$$P(\text{Batch is accepted}) = (1 - p)^8(1 + 8p + 36p^2), 0 \leq p \leq 1$$

(c) Using a graphics calculator, sketch the graph of $P(\text{'Batch is accepted'})$ versus p . Describe the behaviour of this curve.

29. Large batches of screws are produced by TWIST'N'TURN Manufacturers Ltd. Each batch consists of N screws and has a proportion p of defectives. It is decided to carry out an inspection of the product; by selecting 4 screws at random and accepting the batch if there is no more than one defective, otherwise the batch is rejected.

(a) Show that $P(\text{Accepting any batch}) = (1 - p)^3(1 + 3p)$.

(b) Sketch a graph showing the relationship between the probability of accepting a batch and p (the proportion of defectives).

30. A quality control process for a particular electrical item is set up as follows:

A random sample of 20 items is selected. If there is no more than one faulty item the whole batch is accepted. If there are more than two faulty items the batch is rejected. If there are exactly two faulty items, a second sample of 20 items is selected from the same batch and is accepted only if this second sample contains no defective items. Let p be the proportion of defectives in a batch.

(a) Show that the probability, $\Phi(p)$, that a batch is accepted is given by

$$\Phi(p) = (1 - p)^{19}[1 + 19p + 190p^2(1 - p)^{19}], 0 \leq p \leq 1.$$

(b) Find the probability of accepting this batch if it is known that 5% of all items are defective.

(c) If 200 such batches are produced each day, find an estimate of the number of batches that can be expected to be rejected on any one day.

31. [Challenging problem!]

Given that the random variable X denotes the number of successes in n Bernoulli trials, with probability of success on any given trial represented by p .

(a) Find $E(X|X \geq 2)$. (b) Show that $\sigma \leq \frac{1}{2}\sqrt{n}$.

16.4 HYPERGEOMETRIC DISTRIBUTION

16.4.1 HYPERGEOMETRIC DISTRIBUTION FUNCTION

The hypergeometric distribution is a special case of a probability distribution that involves the use of combinations as part of its counting process.

For example, a fish tank contains 5 gold coloured tropical fish and 8 black coloured tropical fish. We wish to determine the probability of obtaining 2 gold coloured fish when selecting a total of 5 fish from the tank.

The first thing that needs to be done is determine the number of ways in which we can select 2 gold fish.

Using our counting principles, this can be carried out in $\binom{5}{2} \times \binom{8}{3}$ ways.

Next, the total number of selections of 5 fish from the possible 13 is given by $\binom{13}{5}$

Therefore, the probability of obtaining 2 gold fish in the sample of 5 is equal to $\frac{\binom{5}{2} \times \binom{8}{3}}{\binom{13}{5}}$.

More formally, if we let the random variable X denote the number of gold coloured fish in the sample of size 5, from a tank containing 5 gold coloured fish and 8 black coloured fish, then, for ‘ $X = 2$ ’, we can write:

$$P(X = 2) = \frac{\binom{5}{2} \times \binom{8}{3}}{\binom{13}{5}}$$

In fact, we could do the same thing with ‘ $X = 0$ ’, ‘ $X = 1$ ’, ‘ $X = 3$ ’, ‘ $X = 4$ ’ and ‘ $X = 5$ ’. i.e., we can write a general formula that will provide the required probabilities:

$$P(X = x) = \frac{\binom{5}{x} \times \binom{8}{5-x}}{\binom{13}{5}}, x = 0, 1, 2, 3, 4, 5$$

We have just produced a probability distribution. In particular, we have produced what is known as a **Hypergeometric Distribution**.

This distribution is formulated around the notion that there are two mutually exclusively groups from which we can select a ‘desired’ outcome. We summarise this process as follows:

For a **population of size N** , which is known to contain **D** ‘defective’ items, if we select a **random sample of size n** from this population and do so **without replacement**, then, if we define the random variable **X** , to be **the number of defectives** observed in the sample of size **n** , we say that **X has a Hypergeometric Distribution**. We denote such a distribution with parameters n, D and N by

$$X \sim Hg(n, D, N)$$

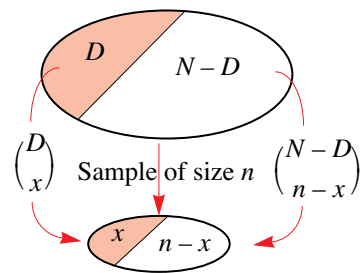

MATHEMATICS – Higher Level (Core)

Using the rules of Chapter 14, a sample containing x defectives and $n - x$ non-defectives can be chosen in $\binom{D}{x} \times \binom{N-D}{n-x}$ ways.

While a sample of n can be selected from a population of size N in $\binom{N}{n}$ ways.

Therefore, if $X \sim Hg(n, D, N)$, then
$$P(X = x) = \frac{\binom{D}{x} \times \binom{N-D}{n-x}}{\binom{N}{n}}, x = 0, 1, 2, \dots, n$$

EXAMPLE 16.20

A sports committee at the local hospital consists of 5 members. A new committee is to be elected, from 5 women and 4 men. What is the probability that the committee will consist of 3 women?

S
o
l
u
t
i
o
n

Let the random variable X denote the number of women on the committee. We can display this situation using the diagram shown. Therefore, using our formula, and the TI-83, we have:

$$P(X = 3) = \frac{\binom{5}{3} \times \binom{4}{2}}{\binom{9}{5}} = \frac{10}{21}$$

```
(5 nCr 3)*(4 nCr 2)
Ans/((9 nCr 5) 60
Ans/((9 nCr 5) 60
Ans/Frac .4761904762
10/21
```

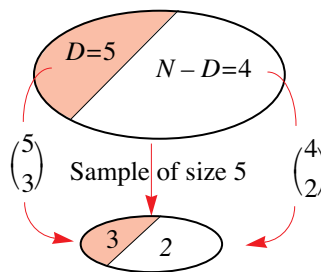

EXAMPLE 16.21

Consider the random experiment of dealing a hand of six cards from a well shuffled pack of 52 cards. Let X be the number of hearts in the hand. What is the probability of being dealt 3 hearts?

S
o
l
u
t
i
o
n

Let the random variable X denote the number of hearts dealt. As before, we can display this situation using the diagram shown.

In other words, we have a Hypergeometric distribution with parameters, $n = 5$, $D = 13$, $N = 52$.

Therefore, using our formula, and the TI-83, we have:

$$P(X = 3) = \frac{\binom{13}{3} \times \binom{39}{3}}{\binom{52}{6}} \approx 0.1284$$

```
(13 nCr 3)*(39 nCr 3)
Ans/((52 nCr 6) .1283862481
```

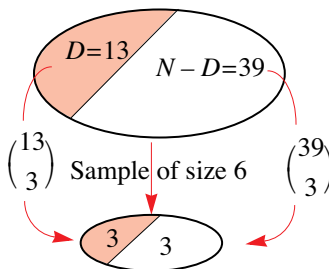

EXAMPLE 16.22

Ten identical cans of soup have no labels. It is known that six of the cans are chicken soup and the rest are pea and ham soup. Five cans are randomly selected from the ten. Find the probability that at least three of them contain chicken soup

**S
o
l
u
t
i
o
n**

Let the random variable X denote the number of cans containing chicken soup. Then, we have that $X \sim Hg(5, 6, 10)$, i.e., Hypergeometric distribution with parameters $n = 5$, $D = 6$ and $N = 10$.

$$\begin{aligned} \text{So, } P(X \geq 3) &= P(X = 3) + P(X = 4) + P(X = 5) = \frac{\binom{6}{3}\binom{4}{2}}{\binom{10}{5}} + \frac{\binom{6}{4}\binom{4}{1}}{\binom{10}{5}} + \frac{\binom{6}{5}\binom{4}{0}}{\binom{10}{5}} \\ &= \frac{120}{252} + \frac{60}{252} + \frac{6}{252} \\ &= \frac{31}{42} \end{aligned}$$

16.4.2 MEAN AND VARIANCE OF THE HYPERGEOMETRIC DISTRIBUTION

Although we can find the expected value and variance of a hypergeometric distribution by setting up a table of values, with a little algebra it can be shown that if the random variable X has a hypergeometric distribution with parameters, n , D and N , i.e., $X \sim Hg(n, D, N)$, then

1. $\mu = E(X) = \frac{nD}{N}$
2. $\sigma^2 = \text{Var}(X) = \frac{nD(N-D)(N-n)}{N^2(N-1)}$

EXAMPLE 16.23

A box contains 12 light globes of which 5 are defective. If three light globes are randomly selected without replacement, find the expected number of defectives in the sample as well as the standard deviation of the number of defectives in the sample.

**S
o
l
u
t
i
o
n**

Let the random variable X denote the number of defective light globes in the sample, then we have that $X \sim Hg(3, 5, 12)$. i.e., $n = 3$, $D = 5$ and $N = 12$.

$$\text{Therefore, } E(X) = \frac{nD}{N} = \frac{3 \times 5}{12} = 1.25$$

$$\text{and } \sigma^2 = \text{Var}(X) = \frac{nD(N-D)(N-n)}{N^2(N-1)} = \frac{3 \times 5 \times (12-5)(12-3)}{12^2 \times (12-1)} = \frac{3 \times 5 \times 7 \times 9}{144 \times 11}$$

$$\text{So that } \sigma = \sqrt{\frac{3 \times 5 \times 7 \times 9}{144 \times 11}} \approx 0.7724.$$

EXERCISES 16.4

1. If X is a random variable such that $X \sim Hg(5, 7, 15)$, i.e., $n = 5$, $D = 7$ and $N = 15$, find
 - (a) $P(X = 3)$
 - (b) $P(X = 4)$

2. If X is a random variable such that $X \sim Hg(10, 7, 20)$, i.e., $n = 10$, $D = 7$ and $N = 20$, find
 - (a) $P(X = 7)$
 - (b) $P(X = 8)$
 - (c) $P(X \geq 2)$

3. If X is a random variable such that $X \sim Hg(3, 4, 10)$, find
 - (a) $E(X)$
 - (b) $Var(X)$

4. If X is a random variable such that $X \sim Hg(4, 5, 12)$, find
 - (a) $E(X^2)$
 - (b) $E(2X)$
 - (c) $Var(X + 1)$

5. A box contains 15 lighters, of which 4 have no gas. A random sample of 4 lighters is selected from the box. Find the probability that this sample contains
 - (a) 4 lighters with no gas.
 - (b) 2 lighters with no gas.

6. Circuits are shipped in boxes of 20. Prior to accepting a box, the retailer chooses five circuits for inspection. If there are more than two defective circuits in the sample, the box is rejected and returned to the manufacturer. A box is known to contain 3 defective circuits. Find the probability that the box is accepted.

7. Julie decides to buy three fruits from a market stall. She asks the merchant to randomly select three pieces of fruit from nine bananas and six oranges, all kept in the same box. Find the probability that Julie buys
 - (a) one banana.
 - (b) at least one banana.

8. A box contains six white discs and four blue discs. A sample of five discs is randomly selected from the box. Let the random variable X denote the number of white discs in the sample.
 - (a) Identify the distribution of X .
 - (b) Find the expected number of white discs in the sample.

9. A carton of eggs contains ten good eggs and two broken eggs. Let the random variable X denote the number of broken eggs found in a sample of three (where sampling occurs without replacement). Find the probability of getting:
 - (a) one broken egg.
 - (b) two broken eggs.

10. A box of chocolates contains 12 dark chocolates and 24 white chocolates. Four people each select a chocolate. What is the probability of getting
 - (a) all white chocolates?
 - (b) two white chocolates?
 - (c) three dark chocolates?

- 11.** A box contains 12 light globes, of which 5 are known to be defective. If three light globes are randomly selected, find the probability that:
- two of them will be defective.
 - at least one of them will be defective.
- 12.** A bag containing 3 rotten apples and 7 good apples has been placed aside and is to be inspected. A sample of three apples is randomly selected from the bag. If the sample has more than one rotten apple, the bag is rejected. Find the probability that the bag is accepted.
- 13.** A batch of 15 electrical components is known to contain 4 defective components. A random sample of four is selected from the batch. Let the random variable X denote the number of defectives in this sample.
- Describe the distribution of X .
 - Write down the distribution of X in table form.

Quality control means that batches are subjected to the following sampling plan:
 If the sample has more than one defective, the batch is rejected, otherwise it is accepted.

- What is the probability that the batch is accepted?
- 14.** A fisherman has caught 16 fish of which 3 are undersized. A random sample of 3 is drawn without replacement by the local ranger. If there is more than one undersized fish in the sample the fisherman is fined. What are the chances of the fisherman being fined?
- 15.** Two boxes each contains 9 sticks of chalk. In box A there are four blue and five white sticks of chalk, whilst in box B there are three blue and six white sticks of chalk. A box is chosen at random and two sticks of chalk are selected without replacement. If X is the event of two blue sticks being drawn and Y is the event of at least one blue stick being drawn, find:
- $P(X)$
 - $P(Y)$
- 16.** Eggs are sold to a customer in boxes of 10. The customer selects two eggs at random from one box without replacement. If both eggs are rotten the customer rejects the box of eggs. Otherwise the customer accepts the box. Consider boxes which contain two rotten eggs.
- What is the probability that a box will be accepted?
 - If four such boxes are selected at random, what is the probability that at least two of them will be accepted?
- 17.** Eggs are sold to a customer in boxes of 10. The customer selects two eggs at random from the box without replacement. If both eggs are rotten the customer rejects the box of eggs. If none are rotten the customer accepts the box. If one of the eggs is rotten the customer selects two more eggs at random from those remaining in the box and then rejects the box if one or more of these is rotten, otherwise the box is accepted. What is the probability that a box which contains four rotten eggs will be accepted?
- 18.** A market stall is offering chickens for sale, however, the customer is worried about the latest outbreak of chicken flu. Consumption of chickens with this flu can be fatal. The consumer decides on the following purchase plan:
 From a batch of 10 he selects 2 chickens and after killing them they are inspected. If neither of the chickens is infected he purchases all 10.
 If one in ten chickens have the flu, what are the chances that the 10 chickens are bought?

MATHEMATICS – Higher Level (Core)

- 19.** Electric light globes are packed in cartons of 12. A quality inspector is to use the following control test to determine the suitability of this carton:
A random sample of 3 is selected without replacement. If there is at most one faulty globe, the carton is accepted and shipped out, otherwise, the carton is emptied and then filled with another 12 globes.

- (a) What is the probability that a carton that is known to contain 3 defective light globes is accepted?
- (b) If there are 8 such cartons, each having 3 defectives, find the probability that
- they are all accepted
 - only half are accepted.

To reduce the rejection rate, if the first testing reveals that there are 2 defectives, a second sample of 2 is taken from the same carton, if neither is found to be defective, the carton is accepted. Otherwise, the carton is rejected.

- (c) Given that a carton contains 3 defectives, find the probability that this carton is accepted.

- 20.** A sports store has in stock 10 boxes of squash balls labelled “Fast”. However, two of the boxes are incorrectly labelled as “Fast”, when in fact they should have been labelled “Slow”.

A squash center orders two boxes of “Fast” balls from this store. Find the probability that it receives

- no incorrectly labelled boxes.
- one incorrectly labelled box.
- two incorrectly labelled boxes.

A squash tournament is being played and the sports center needs two boxes to cover this tournament. The boxes are opened as soon as they are received. If either box is found to be incorrectly labelled it is immediately returned to the store, to be replaced with another box. If necessary, this procedure is repeated. Past experience shows that it takes seven days, after ordering, to receive an order, and seven days to receive a replacement for a returned box. If the tournament is to be held on 21st of July, when should the sports center place their order for the two boxes of “Fast” balls?

- 21.** If $X \sim Hg(n, D, N)$ show that

- (a) $E(X) = \frac{nD}{N}$.
- (b) $Var(X) = \frac{nD(N-D)(N-n)}{N^2(N-1)}$.

- 22.** A customer purchases globes in boxes of 10. The customer decides whether to accept a box by randomly selecting 2 globes from the box without replacement. If neither globe is defective he accepts the box, otherwise, the box is rejected.

- (a) If 5% of all globes manufactured are defective, find the probabilities of finding 0, 1, 2, . . . 10 defective globes in a box.
- (b) Find the probability that boxes that contain 0, 1, 2, . . . 10 defectives are accepted. Hence, find the overall expected proportion of batches accepted.

16.5 POISSON DISTRIBUTION

16.5.1 POISSON DISTRIBUTION FUNCTION

The Poisson distribution was first brought to light by the eminent French mathematician Simeon Denis Poisson (1781 – 1840) in his 1837 work *Recherches sur la probabilité de Jugement*, where he included a limit theorem for the binomial distribution. At the time, this was viewed as little more than a welcome approximation for the difficult computations required when using the binomial distribution. However, this was the embryo from which grew what is now one of the most important of all probability models.

However, a more general (and useful) use of the Poisson distribution [as opposed to only seeing it as an approximation to the binomial under certain conditions] is to define the distribution as

the distribution of the number of ‘events’ in a ‘random process’.

The key in identifying a Poisson distribution, then, is to be able to identify the ‘random process’ and the ‘event’. As we shall see, the event can be distributed over time, or distance, or length, or area, or volume, or . . .

Examples of ‘random processes’ and their corresponding ‘events’ are:

Random process	Event
Telephone calls in a fixed time interval.	Number of wrong calls in an hour. (Time dependent)
Accidents in a factory.	Number of accidents in a day. (Time dependent)
Flaws in a glass panel.	Number of flaws per sq. cm (Area dependent)
Flaws in a string.	Number of flaws per 5 metres. (Length dependent)
Bacteria in milk.	Number of bacteria per 2 litres. (Volume dependent)

The above examples serve to highlight the properties associated with the Poisson distribution. these can be best summarised as:

- 1.** an event is as likely to occur in one given interval as it is in another (equally likely).
- 2.** the occurrence of an event at a ‘point’ – be it a time interval, an area, etc., – is independent of when (or where) other events have occurred.
- 3.** events occur uniformly, i.e., the expected number of events in a given time interval, or area, or, . . . is proportional to the size of the time interval, or area, or, . . .

Note how similar these conditions are to those of the binomial distribution. However, one main difference between the two distributions is that there is, at least theoretically, no upper limit to the number of times an event may occur!

With this in mind, we now provide a statement for the Poisson distribution, incorporating the

distribution function.

If $X(t)$ is the number of events in a time interval of length t , corresponding to a random process, with rate λ per unit time, then, we say that $X(t) \sim Pn(\lambda t)$ – read as *the random variable X has a Poisson distribution with parameter λt* .

Setting $\mu = \lambda t$, we define the Poisson probability distribution as

$$P(X = x) = \frac{e^{-\mu} \mu^x}{x!}, x = 0, 1, 2, \dots$$

Note that the rate λ can be specified as the number of events per unit time, or per unit area, or per unit of volume, or unit of length, etc.,

The best way to see how this works is through the following examples.

EXAMPLE 16.24

Cars have been observed to pass a given point on a backroad at a rate of 0.5 cars per hour. Find the probability that no cars pass this point in a two hour period.

S
o
l
u
t
i
o
n

The description of the situation fits the conditions under which a Poisson distribution can be assumed. From the information given we have that $\lambda = 0.5$.

Next we define the random variable X as the number of cars that pass the given point in a two hour period.

This means that our parameter $\mu = \lambda \times 2 = 0.5 \times 2 = 1$ so that the probability function

for X is given by
$$P(X = x) = \frac{e^{-1} 1^x}{x!}, x = 0, 1, 2, \dots$$

$$\therefore P(X = x) = \frac{e^{-1}}{x!}, x = 0, 1, 2, \dots$$

And so, $P(X = 0) = \frac{e^{-1}}{0!} = 0.3679$.

EXAMPLE 16.25

Faults occur on a piece of string at an average rate of one every three metres. Bobbins, each containing 5 metres of this string are to be used. What is the probability that a randomly selected bobbin will contain

- (a) two faults.
- (b) at least two faults.

S
o
l
u
t
i
o
n

The description of the situation fits the conditions under which a Poisson distribution can be assumed. From the information given we have that $\lambda = \frac{1}{3}$ [i.e., one in three metres].

Next we define the random variable X as the number of faults in a string 5 metres long. That is, number of faults per bobbin.

This means that our parameter $\mu = \lambda \times 5 = \frac{1}{3} \times 5 = \frac{5}{3}$ so that the probability function

for X is given by
$$P(X = x) = \frac{e^{-5/3} \left(\frac{5}{3}\right)^x}{x!}, x = 0, 1, 2, \dots$$

or
$$P(X = x) = \frac{e^{-5/3} \left(\frac{5}{3}\right)^x}{x!}, x = 0, 1, 2, \dots$$

(a)
$$P(X = 2) = \frac{e^{-5/3} \left(\frac{5}{3}\right)^2}{2!} = 0.2623$$

(b)
$$P(X \geq 2) = 1 - P(X < 2) = 1 - [P(X = 0) + P(X = 1)]$$

Now, $P(X = 0) = \frac{e^{-5/3} \left(\frac{5}{3}\right)^0}{0!} = e^{-5/3}$ and $P(X = 1) = \frac{e^{-5/3} \left(\frac{5}{3}\right)^1}{1!} = \frac{5}{3}e^{-5/3}$

$$\begin{aligned} \therefore P(X \geq 2) &= 1 - \left[e^{-5/3} + \frac{5}{3}e^{-5/3} \right] \\ &= 1 - \left[1 + \frac{5}{3} \right] e^{-5/3} \\ &= 1 - \frac{8}{3}e^{-5/3} \\ &= 0.4963 \end{aligned}$$

The calculations, although not difficult, can be time consuming. Making use of the TI-83 will again ease the workload involved. We can access the Poisson distribution function by pressing **2nd VARS** and accessing the **DISTR** menu. Option **B:poissonpdf**(and **C:poissoncdf**(can then be utilised. We use Example 16.24 to illustrate this.

For part (a) we want to find the probability of the event ' $X = 2$ '. Therefore we make use of the **poissonpdf**(:



For part (b) we wanted to find the probability of the event ' $X \geq 2$ '. Therefore we make use of the **poissoncdf**(:



Notice that we have used $1 - P(X \leq 1)$.

Become familiar with using these distributions on the TI-83, as it will reduce your workload.

MATHEMATICS – Higher Level (Core)

Based on these two examples we can set out a general approach to handling questions that require the use of the Poisson distributions:

- Step 1:** Identify that scenario which fits the requirements of a Poisson distribution.
- Step 2:** Determine the ‘base’ rate, λ .
- Step 3:** Define the random variable.
- Step 4:** Determine the parameter, μ , that corresponds to the random variable in Step 3.

EXAMPLE 16.26

A radioactive source emits particles at an average rate of one every 12 seconds. Find the probability that at most 5 particles are emitted in one minute.

Solution

The description of the situation fits the conditions under which a Poisson distribution can be assumed. From the information given we have that $\lambda = \frac{1}{12}$ [i.e., 1 in 12 seconds].

Next we define the random variable X as the number of particles emitted in 1 minute. (or 60 seconds).

This means that our parameter $\mu = \lambda \times 60 = \frac{1}{12} \times 60 = 5$ so that the probability

function for X is given by $P(X = x) = \frac{e^{-5}5^x}{x!}, x = 0, 1, 2, \dots$

Therefore, $P(X \leq 5) = P(X = 0) + P(X = 1) + \dots + P(X = 5)$

$$\begin{aligned} &= \frac{e^{-5}5^0}{0!} + \frac{e^{-5}5^1}{1!} + \dots + \frac{e^{-5}5^5}{5!} \\ &= \left[1 + 5 + \frac{5^2}{2} + \frac{5^3}{6} + \frac{5^4}{24} + \frac{5^5}{120} \right] e^{-5} \\ &= \frac{1097}{12} e^{-5} \\ &= 0.6159 \quad (= 0.6160) \end{aligned}$$

Using the TI-83:

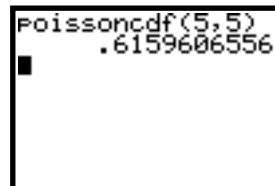

16.5.2 POISSON RECURRENCE FORMULA

If your calculator does not possess a Poisson distribution function, then, a handy expression in calculating probabilities based on the Poisson distribution, where $X \sim Pn(\mu)$ is given by

$$P(X = x + 1) = \frac{\mu}{x + 1} P(X = x), x = 0, 1, 2, \dots$$

This is known as the **Poisson recurrence formula**.

For example, if $X \sim Pn(2)$, we can determine successive probability values by using the

recurrence formula $P(X = x + 1) = \frac{2}{x + 1} P(X = x), x = 0, 1, 2, \dots$

Now, $P(X = 0) = e^{-2} = 0.13534$, and from the recurrence formula we have:

$$P(X = 1) = \frac{2}{0+1}P(X = 0) = 2 \times 0.13533 = 0.27067$$

$$P(X = 2) = \frac{2}{1+1}P(X = 1) = 1 \times 0.27067 = 0.27067$$

$$P(X = 3) = \frac{2}{2+1}P(X = 2) = \frac{2}{3} \times 0.27067 = 0.18045$$

$$P(X = 4) = \frac{2}{3+1}P(X = 3) = \frac{2}{4} \times 0.18044 = 0.09022$$

$$P(X = 5) = \frac{2}{4+1}P(X = 4) = \frac{2}{5} \times 0.09022 = 0.03609$$

: : : :

and so on. . .

16.5.3 MEAN AND VARIANCE OF THE POISSON DISTRIBUTION

With a little algebra, it can be shown that for a random variable X having a Poisson distribution with parameter μ , i.e., if $X \sim Pn(\mu)$, then

1. $E(X) = \mu$
2. $Var(X) = \mu$

EXAMPLE 16.27

A typist finds that, on average, they make two mistakes every three pages. Assuming that the number of errors per page follows a Poisson distribution, what are the chances that there will be 2 mistakes in the next page they type?

S
o
l
u
t
i
o
n

In this case we are given that the average is $\frac{2}{3}$. Then, if we let the random variable N

denote the number of errors per page we have that $E(N) = \frac{2}{3}$, i.e., $\mu = \frac{2}{3}$.

$$\text{So, } P(N = 2) = \frac{e^{-2/3} \left(\frac{2}{3}\right)^2}{2!} = 0.1141.$$

EXAMPLE 16.28

If the random variable X is defined as $X \sim Pn(1.5)$, find $P(X > \mu + \sigma)$.

S
o
l
u
t
i
o
n

As $X \sim Pn(1.5)$ then we have that $\mu = 1.5$ and $\sigma^2 = 1.5 \Rightarrow \sigma = \sqrt{1.5} = 1.2247$.

$$\begin{aligned} \therefore P(X > \mu + \sigma) &= P(X > 1.5 + 1.2247) \\ &= P(X > 2.7247) \\ &= P(X \geq 3) \\ &= 1 - P(X \leq 2) \\ &= 0.1912 \end{aligned}$$

```
1-Poissoncdf(1.5
,2)
.1911531694
```

EXAMPLE 16.29

The frequency distribution shows the number of cars that drive over a bridge in a country area over a period of 100 days. Verify that this follows approximately a Poisson distribution.

Number of cars passing over bridge	0	1	2	3	4
Number of days observed	58	29	10	2	1

S
o
l
u
t
i
o
n

Let the random variable X denote the number of cars that pass over the bridge per day. We first determine the average number of cars that pass over the bridge over the 100 days.

$$\bar{x} = \frac{1}{100}(0 \times 58 + 1 \times 29 + 2 \times 10 + 3 \times 2 + 4 \times 1) = \frac{59}{100} = 0.59$$

That is, on average there are 0.59 cars that pass over the bridge per day.

If this reflects a Poisson distribution, then we can use this mean as an estimate for the parameter μ in the distribution $X \sim Pn(\mu)$.

With $\mu = 0.59$ we have $P(X = x) = \frac{e^{-0.59}(0.59)^x}{x!}, x = 0, 1, 2, 3, \dots$

We can now produce a corresponding frequency distribution:

x	0	1	2	3	4
$P(X = x) = \frac{e^{-0.59}(0.59)^x}{x!}$	0.5543	0.3271	0.0965	0.0190	0.0028

Multiplying these proportions by 100 we deduce the frequency distribution

x	0	1	2	3	4
$100P(X = x)$	55.43	32.71	9.65	1.90	0.28

The frequencies calculated using the Poisson probability function follow a pattern similar to the actual frequencies. We can, therefore, be reasonably sure that the Poisson distribution is an appropriate model for the number of cars that pass over this bridge.

EXAMPLE 16.30

The number of flaws in metal sheets 100 cm by 150 cm is known to follow a Poisson distribution. On inspecting a large number of these metal sheets it is found that 20% of these sheets contain at least one flaw.

- (a) Find the average number of flaws per sheet.
- (b) Find the probability of observing one flaw in a metal sheet selected at random.

S
o
l
u
t
i
o
n

- (a) Let the random variable X denote the number of flaws per 100 cm by 150 cm metal sheets. Then, we have that $X \sim Pn(\mu)$ where μ is to be determined.

Knowing that $P(X \geq 1) = 0.2$ we have, $1 - P(X = 0) = 0.2$

$$\therefore P(X = 0) = 0.8 \Leftrightarrow e^{-\mu} = 0.8$$

$$\Leftrightarrow \mu = 0.2231$$

i.e., average number of flaws per sheet is 0.2232.

- (b) $P(X = 1) = (0.8)(0.2231)^1 = 0.1785$.

16.5.4 POISSON AS A LIMIT OF BINOMIAL

We started this section by mentioning that the Poisson distribution was first encountered as a useful approximation for evaluating probabilities governed by the binomial distribution. We now see why this is the case and provide some conditions for when this approximation is valid.

From the binomial distribution, if the random variable $X \sim \text{Bin}(n, p)$, we have that

$$P(X = x) = \binom{n}{x} p^x (1-p)^{n-x}, x = 0, 1, 2, \dots, n. \quad (1)$$

We know that $E(X) = \mu = np$ therefore, we can write $p = \frac{\mu}{n}$ – (2)

Substituting (2) into (1) we obtain:

$$P(X = x) = \binom{n}{x} \left(\frac{\mu}{n}\right)^x \left(1 - \frac{\mu}{n}\right)^{n-x}, x = 0, 1, 2, \dots, n.$$

Or,

$$\begin{aligned} P(X = x) &= \binom{n}{x} \left(\frac{\mu}{n}\right)^x \left(1 - \frac{\mu}{n}\right)^{-x} \left(1 - \frac{\mu}{n}\right)^n \\ &= \frac{n!}{(n-x)!x!} \left(\frac{\mu}{n}\right)^x \left(1 - \frac{\mu}{n}\right)^{-x} \left(1 - \frac{\mu}{n}\right)^n \\ &= \frac{n!}{(n-x)!x!} \times \frac{\mu^x}{n^x} \left(\frac{n-\mu}{n}\right)^{-x} \left(1 - \frac{\mu}{n}\right)^n \\ &= \frac{\mu^x}{x!} \times \frac{n!}{(n-x)!} \times \frac{1}{n^x} \times \frac{(n-\mu)^{-x}}{n^{-x}} \left(1 - \frac{\mu}{n}\right)^n \\ &= \frac{\mu^x}{x!} \times \frac{n!}{(n-x)!} \times \frac{1}{(n-\mu)^x} \left(1 - \frac{\mu}{n}\right)^n \\ &= \frac{\mu^x}{x!} \times \left[\frac{n!}{(n-x)!(n-\mu)^x} \right] \times \left(1 - \frac{\mu}{n}\right)^n \end{aligned}$$

So far, so good. Now, let us consider the terms $\frac{n!}{(n-x)!(n-\mu)^x}$ and $\left(1 - \frac{\mu}{n}\right)^n$ as $n \rightarrow \infty$:

$$\begin{aligned} \text{We have } \frac{n!}{(n-x)!(n-\mu)^x} &= \frac{n(n-1)(n-2)\dots(n-(x-1))(n-x)!}{(n-x)!(n-\mu)^x} \\ &= \frac{n(n-1)(n-2)\dots(n-(x-1))}{(n-\mu)^x} \\ &= \frac{n(n-1)(n-2)\dots(n-x+1)}{(n-\mu)(n-\mu)(n-\mu)\dots(n-\mu)} \\ &= \frac{n}{(n-\mu)} \times \frac{(n-1)}{(n-\mu)} \times \frac{(n-2)}{(n-\mu)} \times \dots \times \frac{(n-x+1)}{(n-\mu)} \\ &= \left(1 + \frac{\mu}{n-\mu}\right) \times \left(1 + \frac{\mu-1}{n-\mu}\right) \times \dots \times \left(1 + \frac{\mu-x+1}{n-\mu}\right) \end{aligned}$$

Then as $n \rightarrow \infty$ we have that $\left(1 + \frac{\mu}{n-\mu}\right) \rightarrow 1$, $\left(1 + \frac{\mu-1}{n-\mu}\right) \rightarrow 1$, ..., $\left(1 + \frac{\mu-x+1}{n-\mu}\right) \rightarrow 1$

Therefore, $\lim_{n \rightarrow \infty} \frac{n!}{(n-x)!(n-\mu)^x} = 1 \times 1 \times \dots \times 1 = 1$

For the second part, we quote and use the result that $\lim_{n \rightarrow \infty} \left(1 + \frac{x}{n}\right)^n = e^x$.

So that $\lim_{n \rightarrow \infty} \left(1 - \frac{\mu}{n}\right)^n = \lim_{n \rightarrow \infty} \left(1 + \frac{(-\mu)}{n}\right)^n = e^{-\mu}$

Therefore,
$$\begin{aligned} \lim_{n \rightarrow \infty} \binom{n}{x} \left(\frac{\mu}{n}\right)^x \left(1 - \frac{\mu}{n}\right)^{n-x} &= \lim_{n \rightarrow \infty} \frac{\mu^x}{x!} \times \left[\frac{n!}{(n-x)!(n-\mu)^x}\right] \times \left(1 - \frac{\mu}{n}\right)^n \\ &= \frac{\mu^x}{x!} \left[\lim_{n \rightarrow \infty} \frac{n!}{(n-x)!(n-\mu)^x}\right] \left[\lim_{n \rightarrow \infty} \left(1 - \frac{\mu}{n}\right)^n\right] \\ &= \frac{\mu^x}{x!} \times 1 \times e^{-\mu} \\ &= \frac{e^{-\mu} \mu^x}{x} \end{aligned}$$

That is, as $n \rightarrow \infty$, $Bin(n, p) \sim Pn(\mu)$, where $\mu = np$.

Obviously the larger the value of n , the better the approximation. However, a rough guide when considering the use of this approximation is $n \geq 20$ and $p \leq 0.05$ [remember, this is only a guide].

EXAMPLE 16.31

A manufacturer of electrical components finds that in the long run, 2.5% of the components are defective in some way. The inspection procedure requires that batches of 50 components are tested. What is the probability that in a batch of 50 there will be at least 3 defectives?

**S
o
l
u
t
i
o
n**

Let the random variable denote the number of defectives in a batch of 50 components.

Then, $X \sim Bin(50, 0.025)$, i.e., $p = 0.025$ and $n = 50$.

The use of the Poisson approximation in this case would be appropriate as $n \geq 20$ and $p \leq 0.05$.

Now, $\mu = np = 50 \times 0.025 = 1.25$ and so we have that $X \sim Pn(1.25)$.

Therefore, $P(X \geq 3) = 1 - P(X \leq 2) = 1 - [P(X = 0) + P(X = 1) + P(X = 2)]$

$$\begin{aligned} &= 1 - \left[e^{-1.25} + \frac{1.25}{1} e^{-1.25} + \frac{(1.25)^2}{2} e^{-1.25} \right] \\ &= 1 - [1 + 1.25 + 0.78125] e^{-1.25} \\ &= 1 - 3.03125 e^{-1.25} \\ &= 0.1315 \end{aligned}$$

Of course, we could also have made use the TI-83!

EXERCISES 16.5

1. If $X \sim P_n(2)$
 - (a) Write down the probability distribution function for the random variable X .
 - (b) Find

i.	$P(X = 0)$	ii.	$P(X = 2)$
iii.	$P(X > 1)$	iv.	$P(X = 2 X > 1)$

2. The number of flaws in a string occur at a rate of 2 every 5 metres. Find the probability that a string contains 3 flaws in
 - (a) 2 metres of string.
 - (b) 10 metres of string.

3. The number of cars that stop at a particular petrol station during weekdays arrive at a rate of 10 cars every hour. Assuming a Poisson distribution, find the probability that
 - (a) there will be one car at the petrol station during any 15 minute interval.
 - (b) there will be some cars at the petrol station during any 15 minute interval.

4. A switchboard receives an average of 100 calls per hour. Find the probability that
 - (a) the switchboard receives 2 calls during a one minute time interval.
 - (b) the switchboard receives at least 2 calls during a two minute time interval.

5. On average a typist has to correct one word in every 800 words. Each page contains 200 words.
 - (a) Find the probability that the typist makes more than one correction per page.
 - (b) If more than one correction per page is required, the page needs to be retyped. What is the probability that more than two attempts are needed before a page is deemed satisfactory.

6. Cars have been observed to pass a given point on a country road at a rate of 5 cars per hour.
 - (a) Find the probability that no cars pass this point in a 20 minute period.
 - (b) Find the probability that at least 2 cars pass this point in a 30 minute period.

7. Bolts are produced in large quantities and it is expected that there is a 4% rejection rate due to some form of defect. A batch of 40 bolts are randomly selected for inspection. Using the Poisson distribution, find the probability that
 - (a) the batch contains at least one defective.
 - (b) the batch contains no defectives.
 Ten such batches are randomly selected. If it is found that at least 2 batches have at least 4 defective, the total output is considered for the scrap heap to be recycled.
 - (c) Find the probability that the total output is sent to the scrap heap.

8. Road accidents in a certain area occur at an average of 1 every 4 days. Find the probability that during a one week period there will be
 - (a) two accidents.
 - (b) at least two accidents.

9. Telephone calls arrive at a switchboard at a rate of 4 every minute. Find the probability that in a two minute interval there will be less than 6 incoming calls.

MATHEMATICS – Higher Level (Core)

- 10.** The number of faults in glass sheets occur at a rate of 2.1 per sq. metre. If a 1×1 sq. m glass sheet contains at least 3 faults it is returned to the manufacturer.
- Find the probability that a 1×1 sq. m sheet is returned to the manufacturer.
 - Six such glass sheets are inspected. What is the probability that at least half of them are returned to the manufacturer?
- 11.** The number of faults in a glass sheet is known to have a Poisson distribution. It is found that 5% of sheets are rejected because they contain at least one flaw.
- Find the probability that a sheet contains at least two flaws.
 - If the random variable X denotes the number of flaws per sheet, find $P(X > \mu + 2\sigma)$.
- 12.** A shopkeeper finds that the number of orders for an electrical good averages 2 per week. At the start of the trading week, i.e., on a Monday, the shopkeeper has 5 such items in stock. Assuming that the orders follow a Poisson distribution, find the probability that during a given 5 day week
- there are three orders.
 - there are more orders than he can satisfy from his existing stock.
- If and when his stock level is down to two items during the week, he orders another four items.
- What are the chances that he will order another four items?
- 13.** Faults occur randomly along the length of a yarn of wool where the number of faults per bobbin holding a fixed length of yarn may be assumed to follow a Poisson distribution. A bobbin is rejected if it contains at least one fault. It is known that in the long run 33% of bobbins are rejected.
- Find the probability that a rejected bobbin contains only one fault?
- The production manager believes that by doubling the length of yarn on each bobbin there will be a smaller rejection rate. Assuming that the manufacturing process has not altered, is the production manager correct? Provide a quantitative argument.
- 14.** On average, it is found that 8 out of every 10 electric components produced from a large batch has at least one defective component. Find the probability that there will be at least 2 defective components from a randomly selected batch.
- 15.** Flaws, called seeds, in a particular type of glass sheet occur at a rate of 0.05 per square metre. Find the probability that a rectangular glass sheet measuring 4 m by 5 m contains
- no seeds.
 - at least two seeds.
- Sheets containing at least two seeds are rejected.
- Find the probability that in a batch of ten such glass sheets, at most one is rejected.
- 16.** Simar has decided to set up a small business venture. The venture requires Simar to go fishing every Sunday so that he can sell his catch on the Monday. He realises that on a proportion p of these days he does not catch anything.
- Find the probability that on any given Sunday, Simar catches
 - no fish
 - one fish
 - at least two fish
- The cost to Simar on any given Sunday if he catches no fish is \$5. If he catches one fish Simar makes a profit of \$2 and if he catches more than one fish he makes a profit of \$10. Let the random variable X denote the profit Simar makes on any given Sunday.
- Show that $E(X) = 10 - 15p + 8p \ln p$, $0 < p < 1$.
 - Find the maximum value of p , if Simar is to make a positive gain on his venture.

17.1 THE NORMAL DISTRIBUTION

17.1.1 WHY THE NORMAL DISTRIBUTION?

The examples considered in Chapter 16 dealt with data that was **discrete**. Discrete data is generally counted and can be found exactly. Discrete data is often made up of whole numbers. For example, we may have counted the number of occupants in each of the cars passing a particular point over a period of two hours. In this case the data is made up of whole numbers. If we collect information on the European standard shoe sizes of a group of people, we will also be collecting discrete data even though some of the data will be fractional: shoe size nine and a half.

Alternatively, sometimes we collect data using measurement. For example, we might collect the birth weights of all the babies delivered at a maternity hospital over a year. Because weight is a continuous quantity (all weights are possible, not just whole numbers or certain fractions), the data collected is **continuous**. This remains the case even though we usually round continuous data to certain values. In the case of weight, we might round the data to the nearest tenth of a kilogram. In this case, if a baby's weight is given as 3.7kg it means that the weight has been rounded to this figure and lies in the interval [3.65,3.75). If we are looking at data such as these weights it may seem as if the data is discrete even in cases when it is in fact continuous.

When dealing with continuous data, we use different methods. The most important distinction is that we can never give the number of babies that weigh *exactly* 3.7kg as there are *none* of these. All that we can give is the number of babies born that have weights in the range [3.65,3.75).

One of the ways in which we can handle continuous data is to use the **normal distribution**. This distribution is only a model for real data. This means that its predictions are only approximate. The normal distribution generally works best in a situation in which the data clusters about a particular mean and varies from this as a result of **random factors**. The birth weights of babies cluster about a mean with variations from this mean resulting from a range of chance factors such as genetics, nutrition etc. The variation from the mean is measured by the standard deviation of the data. In examples such as this, the normal distribution is often a fairly good model. The basis of all normal distribution studies is the **standard normal curve**.

17.1.2 THE STANDARD NORMAL CURVE

The standard normal curve models data that has a mean of zero and a standard deviation of one. The equation of the standard normal curve is:

$$f(z) = \frac{1}{\sqrt{2\pi}} e^{-\frac{z^2}{2}}, -\infty < z < \infty$$

The equation of this distribution is complex and does not directly give us any information about the distribution. The shape of the curve, does, however, indicate the general shape of the distribution.

The shape of this curve is often referred to as the 'bell shaped curve'. On the next page we see how this function behaves.

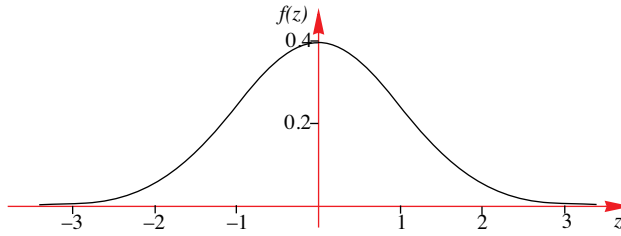

As a result of the fact that the variable z is continuous, it is not the height of the curve but the areas underneath the curve that represent the proportions of the variable that lie between various values. The total area under the curve is 1 (even though the curve extends to infinity in both directions without actually reaching the axis).

For example, the proportion of the standard normal data that lies between 1 and 2 is represented by the area shown.

Areas under curves are usually found using a method covered in Chapter 22. In the case of the normal curve, the complexity of the equation of the graph makes this impossible at least at this level. Instead, we rely on a table of values. The full table can be found at the end of this chapter.

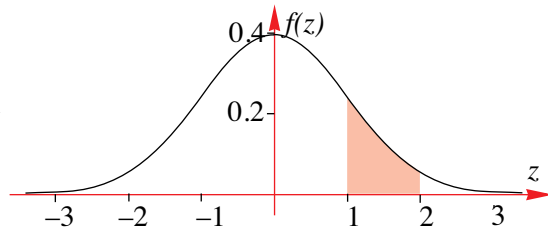

17.1.3 USING THE STANDARD NORMAL TABLE

The table tells us the proportion of values of the standard normal variable that are less than any given value. It is best to view this graphically.

The diagram shows the area that represents the proportion of values for which $z < 2$.

This proportion can also be interpreted as the probability that a randomly chosen value of z will have a value of less than 2 or $p(Z < 2)$. This value can be found from the row beginning with 2.0 in the table:

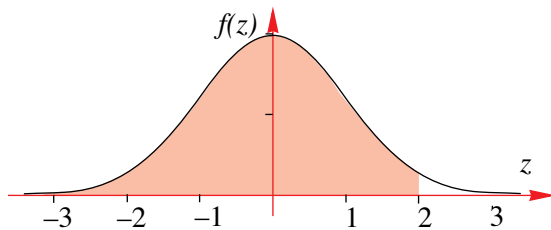

	0	0.01	0.02	0.03	0.04	0.05	0.06	0.07	0.08	0.09
0.0	0.5000	0.5040	0.5080	0.5120	0.5160	0.5199	0.5239	0.5279	0.5319	0.5359
1.8	0.9641	0.9649	0.9656	0.9664	0.9671	0.9678	0.9686	0.9693	0.9699	0.9706
1.9	0.9713	0.9719	0.9726	0.9732	0.9738	0.9744	0.9750	0.9756	0.9761	0.9767
2.0	0.9772	0.9778	0.9783	0.9788	0.9793	0.9798	0.9803	0.9808	0.9812	0.9817
2.1	0.9821	0.9826	0.9830	0.9834	0.9838	0.9842	0.9846	0.9850	0.9854	0.9857
2.2	0.9861	0.9864	0.9868	0.9871	0.9875	0.9878	0.9881	0.9884	0.9887	0.9890

The value in the 2.0 row and 0 column represents $p(Z < 2.0)$ and is 0.9772. This value can be interpreted as:

The proportion of values of z less than 2 is 0.9772

The percentage of values of z less than 2 is 97.72%

The probability that a randomly chosen value of the standard normal variable is less than 2 is 0.9772.

The following set of examples will illustrate how the table can be used to solve other standard normal distribution problems.

EXAMPLE 17.1

For the standard normal variable Z , find:

- (a) $p(Z < 1)$ (b) $p(Z < 0.96)$ (c) $p(Z < 0.03)$

S
o
l
u
t
i
o
n

- (a) All these examples can be solved by direct use of the tables
 $p(Z < 1) = 0.8413$

	0	0.01	0.02	0.03	0.04	0.05	0.06	0.07	0.08	0.09
0.0	0.5000	0.5040	0.5080	0.5120	0.5160	0.5199	0.5239	0.5279	0.5319	0.5359
0.9	0.8159	0.8186	0.8212	0.8238	0.8264	0.8289	0.8315	0.8340	0.8365	0.8389
1.0	0.8413	0.8438	0.8461	0.8485	0.8508	0.8531	0.8554	0.8577	0.8599	0.8621
1.1	0.8643	0.8665	0.8686	0.8708	0.8729	0.8749	0.8770	0.8790	0.8810	0.8830

- (b) $p(Z < 0.96)$ ($= 0.8315$) can be found by using the row for 0.9 and the column for 0.06. The required value can be found at the row and column intersection.

	0	0.01	0.02	0.03	0.04	0.05	0.06	0.07	0.08	0.09
0.0	0.5000	0.5040	0.5080	0.5120	0.5160	0.5199	0.5239	0.5279	0.5319	0.5359
0.8	0.7881	0.7910	0.7939	0.7967	0.7995	0.8023	0.8051	0.8078	0.8106	0.8133
0.9	0.8159	0.8186	0.8212	0.8238	0.8264	0.8289	0.8315	0.8340	0.8365	0.8389
1.0	0.8413	0.8438	0.8461	0.8485	0.8508	0.8531	0.8554	0.8577	0.8599	0.8621

- (iii) $p(Z < 0.03)$ ($= 0.5120$) is found similarly

	0	0.01	0.02	0.03	0.04	0.05	0.06	0.07	0.08	0.09
0.0	0.5000	0.5040	0.5080	0.5120	0.5160	0.5199	0.5239	0.5279	0.5319	0.5359
0.1	0.5398	0.5438	0.5478	0.5517	0.5557	0.5596	0.5636	0.5675	0.5714	0.5753

Other problems are best solved using a combination of graphs and the table. Problems arise when we have ‘greater than’ problems or negative values of z .

EXAMPLE 17.2

For the standard normal variable Z , find:

- (a) $p(Z > 1.7)$ (b) $p(Z < -0.88)$ (c) $p(Z > -1.53)$

S
o
l
u
t
i
o
n

- (a) $p(Z > 1.7)$. Graphically this is the area shaded in the diagram. Since we can only look up ‘less than’ probabilities using the table, we must use the fact that the total area under the curve is 1. It follows that:

$$\begin{aligned}
 p(Z > 1.7) &= 1 - p(Z < 1.7) \\
 &= 1 - 0.9554 \\
 &= 0.0446
 \end{aligned}$$

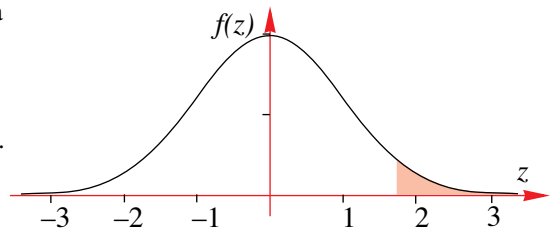

MATHEMATICS – Higher Level (Core)

- (ii) $p(Z < -0.88)$. The table does not give any negative z values. This question can be solved by looking at the diagram on the right. By the symmetry of the curve, the required area (shaded) is the same as the area shown with vertical stripes.

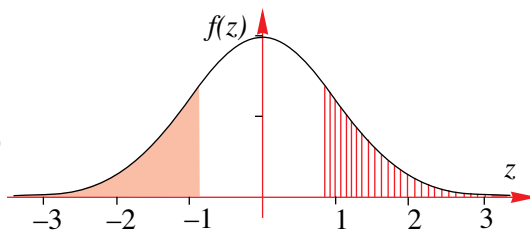

$$\begin{aligned} p(Z < -0.88) &= p(Z > 0.88) \\ &= 1 - p(Z < 0.88) \\ &= 1 - 0.8106 \\ &= 0.1894 \end{aligned}$$

- (c) $p(Z > -1.53)$. Again, we cannot look up a negative z value, but we can use the symmetry of the graph.

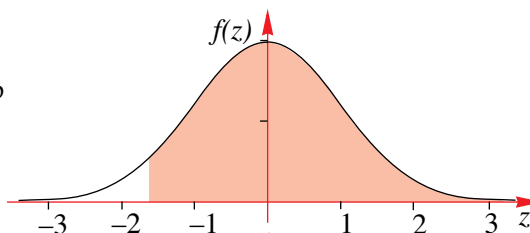

The shaded area in this diagram is the same as the required area in the diagram directly above, so:

$$\begin{aligned} p(Z > -1.53) &= p(Z < 1.53) \\ &= 0.9370 \end{aligned}$$

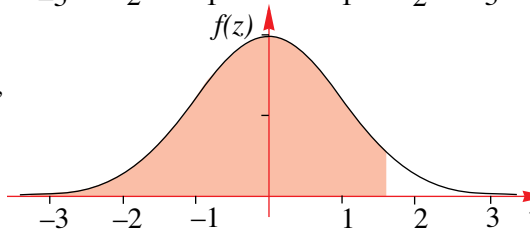

The final set of examples looks at some ‘between values’ type of problems.

EXAMPLE 17.3

For the standard normal variable Z , find:

- (a) $p(1.7 < Z < 2.5)$ (b) $p(-1.12 < Z < 0.67)$ (c) $p(-2.45 < Z < -0.08)$

S
o
l
u
t
i
o
n

- (a) $p(1.7 < Z < 2.5)$. This is found by using the tables to find $p(Z < 2.5)$ and $p(Z < 1.7)$.

The required answer is then the difference between these two values.

$$\begin{aligned} p(1.7 < Z < 2.5) &= p(Z < 2.5) - p(Z < 1.7) \\ &= 0.9938 - 0.9554 \\ &= 0.0384 \end{aligned}$$

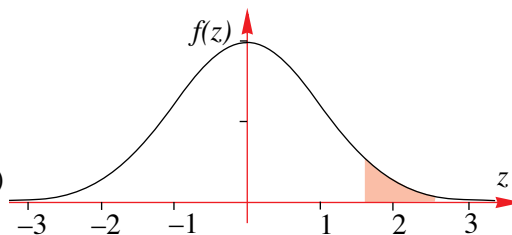

- (b) $p(-1.12 < Z < 0.67)$. The area is shown shaded. The same principal is used to solve this problem as the previous example.

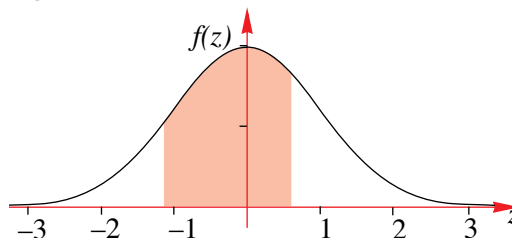

The additional difficulty is the negative z value.

i.e., $p(-1.12 < Z)$ is calculated as $p(Z > 1.12) = 1 - p(Z < 1.12)$.

$$\begin{aligned} \therefore p(-1.12 < Z < 0.67) &= p(Z < 0.67) - p(Z < -1.12) \\ &= p(Z < 0.67) - p(Z > 1.12) \\ &= p(Z < 0.67) - (1 - p(Z < 1.12)) \\ &= 0.7486 - (1 - 0.8686) \\ &= 0.6172 \end{aligned}$$

- (c) $p(-2.45 < Z < -0.08)$ (shaded) is calculated using the symmetry of the curve as $p(0.08 < Z < 2.45)$ (vertical stripes), so,

$$\begin{aligned} p(-2.45 < Z < -0.08) &= p(0.08 < Z < 2.45) \\ &= 0.9928 - 0.5319 \\ &= 0.4609 \end{aligned}$$

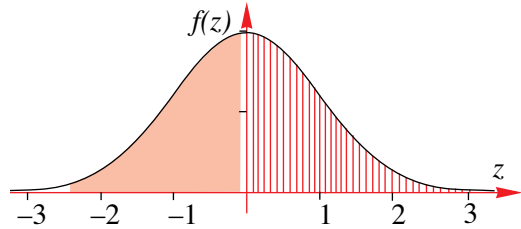

EXERCISES 17.1

- For the standard normal variable Z , find:

(i) $p(Z < 0.5)$	(ii) $p(Z < 1.84)$	(iii) $p(Z < 1.62)$	(iv) $p(-2.7 < Z)$
(v) $p(-1.97 < Z)$	(vi) $p(Z < -2.55)$	(vii) $p(1.9 < Z)$	(viii) $p(Z < -1.56)$
(ix) $p(2.44 < Z)$	(x) $p(-0.95 < Z)$	(xi) $p(Z < 0.37)$	(xii) $p(1.39 < Z)$
- For the standard normal variable z , find:

(i) $p(1.75 < Z < 2.65)$	(ii) $p(0.3 < Z < 2.5)$	(iii) $p(1.35 < Z < 1.94)$
(iv) $p(-1.92 < Z < -1.38)$	(v) $p(2.23 < Z < 2.92)$	(vi) $p(-1.51 < Z < -0.37)$
(vii) $p(-2.17 < Z < 0.76)$	(viii) $p(1.67 < Z < 2.22)$	(ix) $p(-0.89 < Z < 0.8)$
(x) $p(-2.64 < Z < -1.04)$	(xi) $p(-1.43 < Z < 2.74)$	(xii) $p(-1.59 < Z < -0.46)$
(xiii) $p(-2.12 < Z < 0.58)$	(xiv) $p(-2.61 < Z < 1.39)$	(xv) $p(-1.86 < Z < 0.13)$
(xvi) $p(-2.56 < Z < 0.92)$	(xvii) $p(-1.75 < Z < 2.03)$	(xviii) $p(-0.9 < Z < 1.34)$

17.2 FORMALISING THE DEFINITION OF THE NORMAL DISTRIBUTION

So far we have given a discussion of the notion of the standard normal distribution. We now provide a more mathematical approach in defining this important distribution.

17.2.1 THE NORMAL DISTRIBUTION

If the random variable X is normally distributed, then it has a **probability density function** given

by

$$f(x) = \frac{1}{\sigma\sqrt{2\pi}} e^{-\frac{1}{2}\left(\frac{x-\mu}{\sigma}\right)^2}, \quad -\infty < x < \infty$$

Where $\mu = E(X)$, the mean of X , and $\sigma = Sd(X)$, the standard deviation of X , are known as the **parameters of the distribution**.

If the random variable X is normally distributed with mean μ and variance σ^2 , we write

$$X \sim N(\mu, \sigma^2)$$

The shape of this probability density function, known as the **normal curve**, has a characteristic ‘bell shape’ that is symmetrical about its mean, μ .

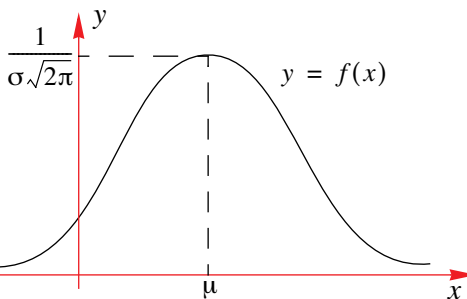

17.2.2 PROPERTIES OF THIS CURVE

1. The curve is **symmetrical** about the line $x = \mu$. In fact, the mode occurs at $x = \mu$.
2. The normal curve approaches the horizontal axis asymptotically as $x \rightarrow \pm\infty$.
3. The area under this curve is equal to one.

That is,
$$\int_{-\infty}^{\infty} f(x)dx = \int_{-\infty}^{\infty} \frac{1}{\sigma\sqrt{2\pi}} e^{-\frac{1}{2}\left(\frac{x-\mu}{\sigma}\right)^2} dx = 1.$$

4. Approximately 95% of the observations lie in the region $\mu - 2\sigma \leq x \leq \mu + 2\sigma$.

17.2.3 FINDING PROBABILITIES USING THE NORMAL DISTRIBUTION

To find the probability, $p(a \leq X \leq b)$, where $X \sim N(\mu, \sigma^2)$ we would need to evaluate the

integral:
$$p(a \leq X \leq b) = \int_a^b f(x)dx = \int_a^b \frac{1}{\sigma\sqrt{2\pi}} e^{-\frac{1}{2}\left(\frac{x-\mu}{\sigma}\right)^2} dx.$$

Evaluating such an integral is beyond the scope of this course. However, to help us calculate such probabilities we make use of a **transformation** that will convert any normal distribution with mean μ and variance σ^2 to a normal distribution with a **mean of 0 and a variance of 1**. This new curve is known as a **standard normal distribution**.

17.2.4 THE STANDARD NORMAL DISTRIBUTION

Making use of the transformation $Z = \frac{X - \mu}{\sigma}$, we obtain the standard normal distribution.

That is, we transform the distribution of $X \sim N(\mu, \sigma^2)$ to that of $Z \sim N(1, 0)$.

This can be shown as follows:

1.
$$E(Z) = E\left(\frac{X - \mu}{\sigma}\right) = \frac{1}{\sigma}E(X - \mu) = \frac{1}{\sigma}(E(X) - \mu) = \frac{1}{\sigma}(\mu - \mu) = 0$$

2.
$$Var(Z) = Var\left(\frac{X - \mu}{\sigma}\right) = \frac{1}{\sigma^2}Var(X - \mu) = \frac{1}{\sigma^2}Var(X) = \frac{1}{\sigma^2} \times \sigma^2 = 1$$

That is,

$$X \sim N(\mu, \sigma^2) \Rightarrow Z = \frac{X - \mu}{\sigma} \sim N(1, 0)$$

This means that the probability density function of the standard normal distribution, Z ,

(with mean $\mu = 0$ and variance $\sigma^2 = 1$) is given by $f(z) = \frac{1}{\sqrt{2\pi}} e^{-\frac{1}{2}z^2}$

So that the probability is now given by $p(a \leq Z \leq b) = \int_a^b \frac{1}{\sqrt{2\pi}} e^{-\frac{1}{2}z^2} dz$

Although we still have the difficulty of evaluating this definite integral, the reason for doing this is that we have at our disposal tables that already have the probability (area) under the standard normal curve, as we have already seen in §17.1. It is from such tables that we can then calculate the required probabilities. These calculations can also be carried out using specialised calculators.

17.2.5 FINDING PROBABILITIES

Tables usually indicate the region (i.e., the area) that is being evaluated by displaying a graph of the standard normal curve together with the shaded region.

What follows are results based on tables that provide probabilities for which the shaded region is to the left of z . That is, the probability that z is less than (or equal to) a is given by

$p(Z < a) = \text{shaded region to the left of } z = a, a > 0.$

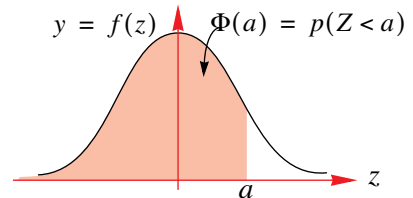

We usually denote this area by $\Phi(a)$.

That is, $\Phi(a) = p(Z \leq a) = \int_{-\infty}^a \frac{1}{\sqrt{2\pi}} e^{-\frac{1}{2}z^2} dz$

The notation $\Phi(a)$ is very useful as it allows us to deal with probabilities in the same way as we would deal with functions. In §17.1 the table of the standard normal probabilities was introduced so that we could familiarise ourselves with how probabilities could be evaluated immediately or by making use of the symmetry properties of the normal curve. We summarise the symmetry properties that were seen to be useful in evaluating probabilities:

If $a \geq 0, b \geq 0$ and Z has a **standard normal distribution**, we have the standard results:

1. $p(Z < a) = \Phi(a)$

In this case we look up the tables
e.g $p(Z < 2.10) = \Phi(2.01) = 0.9778$

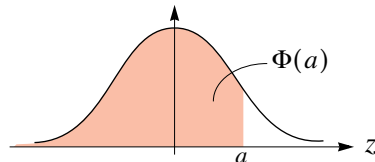

2. $p(Z > a) = 1 - p(Z < a) = 1 - \Phi(a)$

e.g $p(Z > 1.54) = 1 - p(Z < 1.54)$
 $= 1 - \Phi(1.54)$
 $= 1 - 0.9382$
 $= 0.0618$

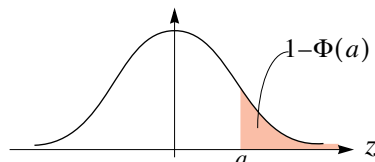

3. $p(Z < -a) = p(Z > a) = 1 - \Phi(a)$

e.g $p(Z < -1.26) = p(Z > 1.26)$
 $= 1 - \Phi(1.26)$
 $= 1 - 0.8962$
 $= 0.1038$

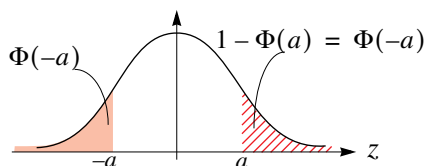

4. $p(Z > -a) = p(Z < a) = \Phi(a)$

e.g $p(Z > -0.1) = p(Z < 0.1) = 0.5398$

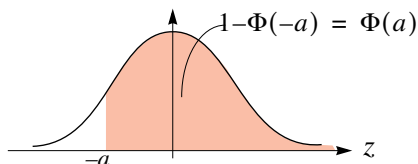

5. $p(a < Z < b) = p(Z < b) - p(Z < a)$
 $= \Phi(b) - \Phi(a)$

e.g $p(0.40 < Z < 1.2) = p(Z < 1.2) - p(Z < 0.4)$
 $= 0.8849 - 0.6554$
 $= 0.2295$

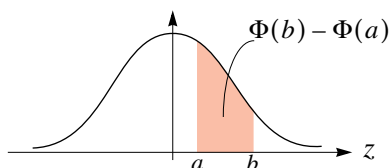

All of this is very good, if we are dealing with the standard normal distribution. However, most of the time (if not practically, all of the time) the data collected will be such that we do not have a mean of zero and a variance of 1. That is, the information gathered from a population (concerning some attribute) will be presented in such a way that the mean and the variance will not comply with those of the standard normal distribution. And so, it will be necessary to first carry out the transformation which we have already discussed, and then work out the required probabilities. That is, we will need to first standardise the statistics obtained from our data, using the Z-transformation, and then use the standard normal distribution table.

17.2.6 STANDARDISING ANY NORMAL DISTRIBUTION

Very few practical applications will have data whose mean is 0 and whose standard deviation is 1. The standard normal curve is, therefore, not directly usable in most cases. We get over this difficulty by relating every problem to the standard normal curve.

As we have already seen, a general variable, X , is related to the standard normal variable, Z , using the relation: $Z = \frac{X - \mu}{\sigma}$ where μ = the mean of the data and σ is the standard deviation.

We use an example to illustrate this.

EXAMPLE 17.4

A production line produces bags of sugar with a mean weight of 1.01kg and a standard deviation of 0.02kg.

- (a) Find the proportion of the bags that weigh less than 1.03kg
- (b) Find the proportion of the bags that weigh more than 1.02kg
- (c) Find the percentage of the bags that weigh between 1.00kg and 1.05kg.

S
o
l
u
t
i
o
n

- (a) The first step is to relate the x value of 1.03 to the z value using the values of the mean and standard deviation. So, we have that $z = \frac{x - \mu}{\sigma} = \frac{1.03 - 1.01}{0.02} = 1$

Graphically, this means that we have related the normal distribution that models the weights of the bags of sugar to the standard normal distribution.

Distribution of weights of sugar bags

Standard normal distribution

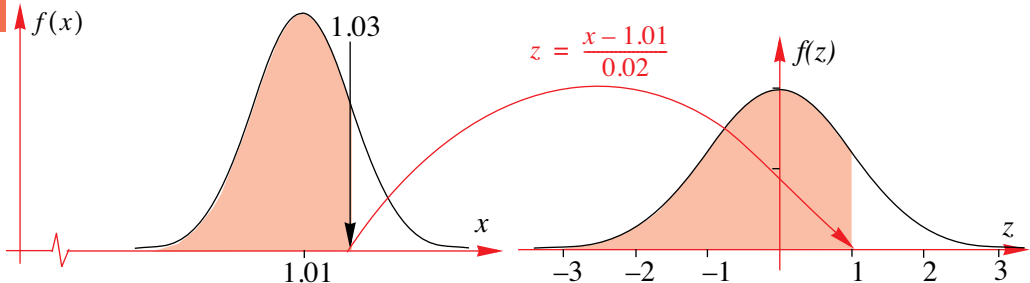

The problem that we are trying to solve: $p(X < 1.03)$ has the same solution as the standard problem $p(Z < 1)$. This can be solved directly from the table to get 0.8413.

- (b) Again, transforming this into a standard problem with $x = 1.02$ gives:

$$z = \frac{x - \mu}{\sigma} = \frac{1.02 - 1.01}{0.02} = 0.5$$

Graphically, this is:

Distribution of weights of sugar bags

Standard normal distribution

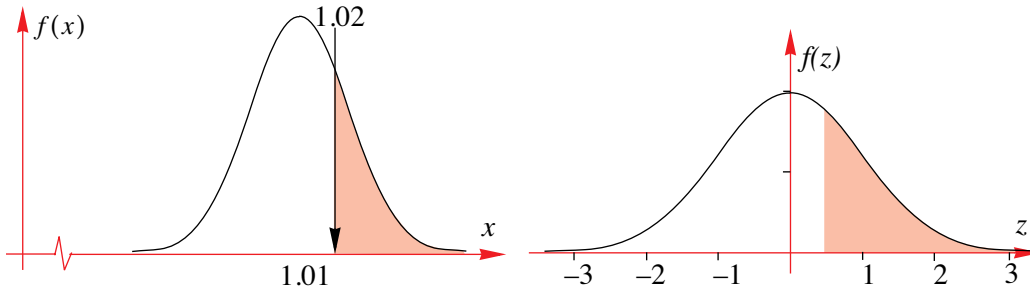

$$\begin{aligned} p(X > 1.02) &= p(Z > 0.5) = 1 - p(Z < 0.5) \\ &= 1 - 0.6915 \\ &= 0.3085 \end{aligned}$$

- (c) Again, transforming both the x values to z values, we get:

$$z_1 = \frac{x_1 - \mu}{\sigma} = \frac{1 - 1.01}{0.02} = -0.5 \text{ and } z_2 = \frac{x_2 - \mu}{\sigma} = \frac{1.05 - 1.01}{0.02} = 2$$

The graphical interpretation of this is:

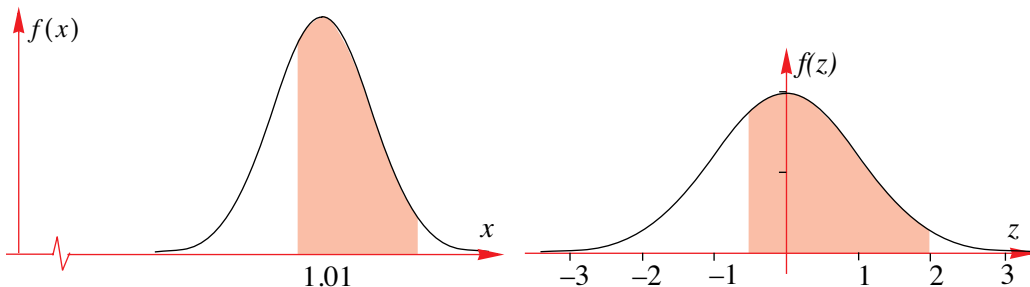

The solution is now found in a similar way to the above examples:

$$\begin{aligned}
 p(1 < X < 1.05) &= p(-0.5 < Z < 2) \\
 &= p(Z < 2) - p(Z < -0.5) \\
 &= p(Z < 2) - p(Z > 0.5) \\
 &= p(Z < 2) - (1 - p(Z < 0.5)) \\
 &= 0.9772 - (1 - 0.6915) \\
 &= 0.6687
 \end{aligned}$$

SUMMARY

When evaluating probabilities for a random variable X which is **normally distributed** (as opposed to X having a **standard normal distribution**), the following steps should be carried out:

- Step 1:** Find the value of z which corresponds to the value of x .
That is, transform the given random variable X , which is $X \sim N(\mu, \sigma^2)$ to that of $Z \sim N(1, 0)$, using the transformation $Z = \frac{X - \mu}{\sigma}$.
- Step 2:** Sketch a diagram of the standard normal curve with the required region shaded.
- Step 3:** Use the standard normal distribution tables to evaluate the required region.
NB: This last step often requires the use of the symmetrical properties of the curve to be able to evaluate the required region.

So far we have been making use of the probability tables for the standard normal distribution. However, a graphics calculator is extremely useful in cutting down the workload when determining these probabilities. It is highly recommended that you become familiar with these functions on your calculator. We illustrate this in this next example.

EXAMPLE 17.5

X is a normal random variable with mean $\mu = 80$ and variance $\sigma^2 = 16$,
find (a) $p(X \leq 78)$ (b) $p(76 \leq X \leq 84)$ (c) $p(X \geq 86)$

S
O
L
I
T
I
O
N

$$\begin{aligned}
 \text{(a)} \quad p(X \leq 78) &= p\left(Z \leq \frac{78 - \mu}{\sigma}\right) = p\left(Z \leq \frac{78 - 80}{4}\right) \\
 &= p(Z \leq -0.5) \\
 &= 1 - p(Z \leq 0.5) \\
 &= 1 - 0.6915 \\
 &= 0.3085
 \end{aligned}$$

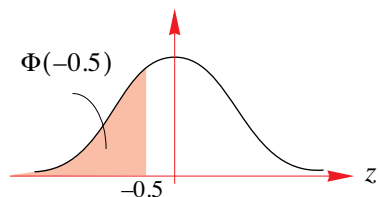

$$\begin{aligned}
 \text{(b)} \quad p(76 \leq X \leq 84) &= p\left(\frac{76 - 80}{4} \leq Z \leq \frac{84 - 80}{4}\right) \\
 &= p(-1 \leq Z \leq 1) \\
 &= 0.6826
 \end{aligned}$$

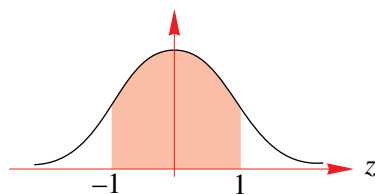

Notice that: $p(-1 \leq Z \leq 1) = \Phi(1) - \Phi(-1)$
 $= \Phi(1) - (1 - \Phi(1))$
 $= 2\Phi(1) - 1$

$$\begin{aligned}
 \text{(c)} \quad p(X \geq 86) &= p\left(Z \geq \frac{86 - 80}{4}\right) = p(Z \geq 1.5) \\
 &= 1 - p(Z \leq 1.5) \\
 &= 1 - 0.9332 \\
 &= 0.0668
 \end{aligned}$$

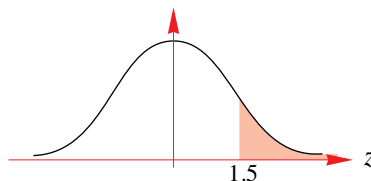

We now make use of the TI-83 to find these probabilities using the **DISTR** function:

(a) $p(Z \leq -0.5)$:

First, set up the window using an appropriate scale:

```

WINDOW
Xmin=-3
Xmax=3
Xscl=1
Ymin=-.25
Ymax=.5
Yscl=.25
Xres=1
    
```

Using a domain of $[-3,3]$ will be sufficient in most cases.

Next, follow through each of the displays shown:

```

1
2: normalpdf(
3: in
4: t: DISTR 0.3085
5: tc 2: Shade
6: x2: 3: Sha
7: x2: 4: Sha
    
```

After using the **ShadeNorm**(function, use the **ENTER** function:

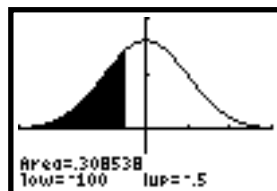

Notice: we have used a lower bound of -100 , so that in fact, we are finding $p(-100 \leq Z \leq 0.5)$.

Having such a 'large' lower bound (of -100 say), provides an accurate (at least to 4 d.p) value for $p(Z \leq 0.5)$. That is, $p(Z \leq 0.5) = p(-100 \leq Z \leq 0.5) = 0.3085$.

It should be noted that although we are using values obtained after carrying out the standardization process, the TI-83 also enables us to find the required probability directly. We show this next:

This time the window has been set to reflect the information based on the data:

```

WINDOW
Xmin=65
Xmax=95
Xscl=5
Ymin=-.05
Ymax=.1
Yscl=.05
Xres=
    
```

Again, we use a 'large' lower bound, the upper limit and then the parameters:

```

ShadeNorm(-1000,
78.80,4)
    
```

The graph shows the actual curve defined by its parameters:

$$f(x) = \frac{1}{4\sqrt{2\pi}} e^{-\frac{1}{2}\left(\frac{x-80}{4}\right)^2}$$

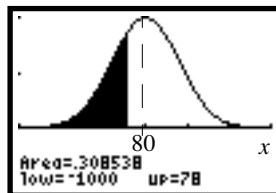

(b) Similarly, we have:

```

ShadeNorm(-1,1)
    
```

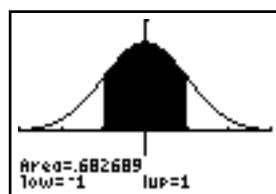

- (c) This time we use a large upper bound:

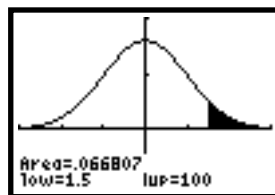
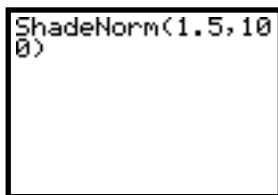

Note that it is not necessary to use the **ShadeNorm**(option on the TI-83. If you are not interested in seeing a sketch of the graph and its shaded region, but instead only want the probability, then make use of the **normalcdf**(option in the **DIST** menu.

We illustrate this for the previous example using **normalcdf**(lower value, upper value, μ , σ):

(a)

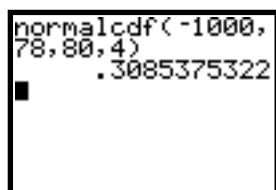

(b)

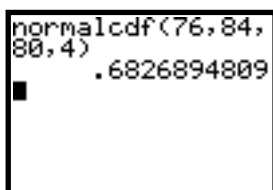

(c)

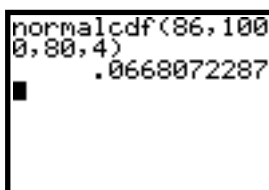

17.2.7 INVERSE PROBLEMS

There are occasions when we are told the proportion of the data that we are to consider and asked questions about the data conditions that are appropriate to these proportions.

EXAMPLE 17.6

Find the values of a in each of these statements that refer to the standard normal variable, z .

- (a) $p(Z < a) = 0.5478$ (b) $p(Z > a) = 0.6$ (c) $p(Z < a) = 0.05$

S
o
l
u
t
i
o
n

- (a) $p(Z < a) = 0.5478$. In this case, we are given the proportion and asked for the value of z which makes the condition true. Because we know the proportion, we must look for the figure 0.5478 in the body of the table.

	0	0.01	0.02	0.03	0.04	0.05	0.06	0.07	0.08	0.09
0.0	0.5000	0.5040	0.5080	0.5120	0.5160	0.5199	0.5239	0.5279	0.5319	0.5359
0.1	0.5398	0.5438	0.5478	0.5517	0.5557	0.5596	0.5636	0.5675	0.5714	0.5753
0.2	0.5793	0.5832	0.5871	0.5910	0.5948	0.5987	0.6026	0.6064	0.6103	0.6141

Once the figure has been found in the table, it is necessary to infer the value of z that fits the condition. In this case the value is in the row for 0.1 and the column for 0.02 and we can infer that $a = 0.12$. You should check that $p(Z < 0.12) = 0.5478$.

- (b) $p(Z > a) = 0.6$. This is a ‘greater than’ problem and must be converted into the ‘less than’ problem $p(Z < a) = 0.4$

From the diagram, it is evident that a is negative. This gives us a problem as negative values are not present on the table.

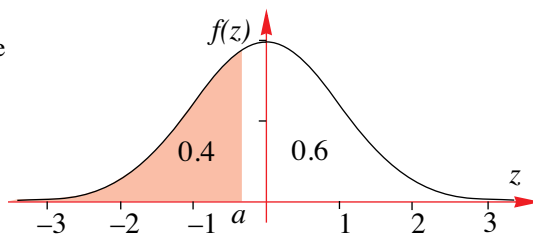

In this case, consider the associated problem $p(Z < b) = 0.6$.

By symmetry, if we can find the appropriate value of b , a will follow because $a = -b$.

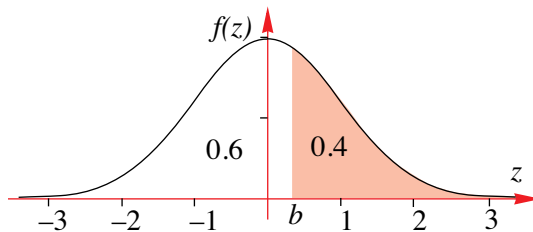

There is a second problem as 0.6 is not present (exactly) in the table. In this case, we find the entries that are as close to 0.6 as possible.

	0	0.01	0.02	0.03	0.04	0.05	0.06	0.07	0.08	0.09
0.0	0.5000	0.5040	0.5080	0.5120	0.5160	0.5199	0.5239	0.5279	0.5319	0.5359
0.1	0.5398	0.5438	0.5478	0.5517	0.5557	0.5596	0.5636	0.5675	0.5714	0.5753
0.2	0.5793	0.5832	0.5871	0.5910	0.5948	0.5987	0.6026	0.6064	0.6103	0.6141
0.3	0.6179	0.6217	0.6255	0.6293	0.6331	0.6368	0.6406	0.6443	0.6480	0.6517

From the table, $p(Z < 0.25) = 0.5987$ and $p(Z < 0.26) = 0.6026$ it is clear that the correct value of b is between 0.25 and 0.26 and closer to 0.25 than to 0.26 as 0.5987 is closer to 0.6 than is 0.6026. A reasonable value for b would seem to be about 0.253. There are several ways in which we could do better than this. Some texts provide ‘difference values’ in the main table and a separate inverse table. At the time of writing, neither of these were provided in IB exams. Also, there is a technique known as linear interpolation that can make the above argument more precise, but this is not strictly necessary in most applications. In the present case, $b \approx 0.253$ so the answer to our problem is that $a \approx -0.253$.

- (iii) $p(Z < a) = 0.05$. Again, thinking graphically, there is a better associated problem:

$p(Z < a) = 0.05$ is the same as
 $p(Z > b) = 0.05$ or $p(Z < b) = 0.95$

By symmetry $a = -b$.

Looking for the closest value to 0.95 in the table gives $b \approx 1.645$ and $a \approx -1.645$

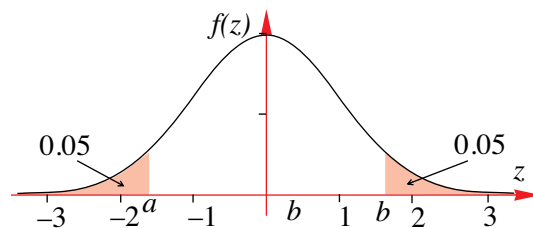

	0	0.01	0.02	0.03	0.04	0.05	0.06	0.07	0.08	0.09
1.6	0.9452	0.9463	0.9474	0.9484	0.9495	0.9505	0.9515	0.9525	0.9535	0.9545

As we saw in Example 17.5 (b) and (c), finding the inverse values can sometimes require an approximation. However, recall that we had defined the function $\Phi(a)$ as a means to represent the probability, $p(Z \leq a)$. We will now make use of this function to help us deal with a more

general approach to solving inverse problems.

17.2.8 FINDING QUANTILES

To find a quantile (or percentile) means to find the value of a , where $p(X \leq a) = p$, where p is the p th percentile.

As we saw in the previous section, the process only requires that we read the normal distribution tables in reverse (or use the **Inverse Cumulative Normal Distribution Table** (if one is provided).

Dealing with this problem using mathematical notation we have,

$$p(X \leq a) = p \Leftrightarrow p\left(Z \leq \frac{a - \mu}{\sigma}\right) = p \text{ where } 0 \leq p \leq 1$$

$$\therefore \frac{a - \mu}{\sigma} = \Phi^{-1}(p)$$

For which we then solve for a .

To find the value of $\Phi^{-1}(p)$, we can look up the Normal tables in reverse, however, making use of a calculator reduces the workload significantly and increases the accuracy of the results.

On the TI-83, the inverse values are obtained by accessing the **invNorm**(option in the **DIST** menu. To use the **invNorm**(option we must have the z -values, i.e., the **standardised** values.

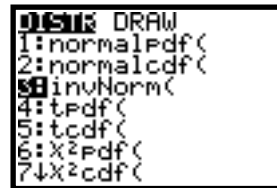

We illustrate this with the following examples.

EXAMPLE 17.7

If $X \sim N(100, 25)$ find the value of k , such that (a) $p(X \leq k) = 0.90$
 (b) $p(X \leq k) = 0.20$.

S
O
L
V
E
D
E
D

(a) $p(X \leq k) = 0.90 \Leftrightarrow p\left(Z \leq \frac{k - 100}{5}\right) = 0.90$

Therefore,
$$\frac{k - 100}{5} = 1.2816$$

$$\Rightarrow k = 106.408$$

(b) $p(X \leq k) = 0.20 \Leftrightarrow p\left(Z \leq \frac{k - 100}{5}\right) = 0.20$

Therefore,
$$\frac{k - 100}{5} = -0.8416$$

$$k = 100 + 5(-0.8416)$$

$$= 95.792$$

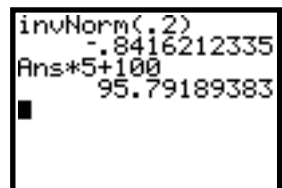
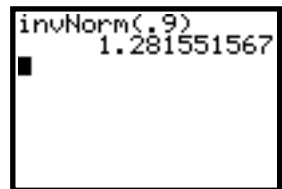

EXAMPLE 17.8

The Board of Examiners have decided that 85% of all candidates sitting Mathematical Methods will obtain a pass grade in the examination. The actual examination marks are found to be normally distributed with a mean of 55 and a variance of 16. What is the lowest score a student can get on the exam to be awarded a pass grade?

S
o
l
u
t
i
o
n

Let the random variable X denote the exam score. We then have that $X \sim N(55, 16)$. We now need to find the score x , such that $p(X \geq x) = 0.85$ (or $p(X \leq x) = 0.15$).

$$\text{Now, } p(X \leq x) = 0.15 \Leftrightarrow p\left(Z \leq \frac{x-55}{4}\right) = 0.15$$

$$\Leftrightarrow \frac{x-55}{4} = -1.0364$$

$$\Leftrightarrow x = 55 + 4(-1.0363)$$

$$\therefore x = 50.8544$$

```
invNorm(.15)
-1.03643338
4*Ans+55
50.85426648
```

Therefore a student needs to score at least 51 marks to pass the exam.

EXAMPLE 17.9

The lifetime of a particular make of television tube is normally distributed with a mean of 8 years, and a standard deviation of σ years. The chances that the tube will not last 5 years is 0.05. What is the value of the standard deviation?

S
o
l
u
t
i
o
n

Let X denote the life-time of the television tubes, so that $X \sim N(8, \sigma^2)$.

$$\text{Given that } p(X < 5) = 0.05 \Rightarrow p\left(Z < \frac{5-8}{\sigma}\right) = 0.05.$$

$$\text{That is, we have that } p\left(Z < -\frac{3}{\sigma}\right) = 0.05$$

$$\Leftrightarrow -\frac{3}{\sigma} = -1.6449$$

$$\Leftrightarrow \sigma = 1.8238$$

```
invNorm(.05)
-1.644853626
-3/Ans
1.823870497
```

And so the standard deviation is approximately one year and 10 months.

EXAMPLE 17.10

The weight of a population of men is found to be normally distributed with mean 69.5 kg. 13% of the men weigh at least 72.1 kg, find the standard deviation of their weight.

S
o
l
u
t
i
o
n

Let the random variable X denote the weight of the men, so that $X \sim N(69.5, \sigma^2)$.

We then have that $p(X \geq 72.1) = 0.13$ or $p(X \leq 72.1) = 0.87$.

$$\therefore p\left(Z \leq \frac{72.1-69.5}{\sigma}\right) = 0.87 \Leftrightarrow \frac{72.1-69.5}{\sigma} = 1.1264$$

$$\therefore \sigma = 2.3083$$

```
(72.1-69.5)/invN
orm(.87)
2.308256818
```

EXERCISES 17.2

1. If Z is a standard normal random variable, find

(a) $p(Z > 2)$	(b) $p(Z < 1.5)$	(c) $p(Z \geq 0.5)$
(d) $p(Z \leq 1.2)$	(e) $p(Z \geq 1.5)$	(f) $p(Z \leq 2)$

2. If Z is a standard normal random variable, find

(a) $p(Z > -2)$	(b) $p(Z < -1.5)$	(c) $p(Z \geq -0.5)$
(d) $p(Z \leq -1.2)$	(e) $p(Z \geq -1.5)$	(f) $p(Z \leq -2)$

3. If Z is a standard normal random variable, find

(a) $p(0 \leq Z \leq 1)$	(b) $p(1 \leq Z \leq 2)$	(c) $p(1.5 \leq Z < 2.1)$
--------------------------	--------------------------	---------------------------

4. If Z is a standard normal random variable, find

(a) $p(-1 \leq Z \leq 1)$	(b) $p(-2 \leq Z \leq -1)$	(c) $p(-1.5 \leq Z < -0.1)$
---------------------------	----------------------------	-----------------------------

5. If X is a normal random variable with mean $\mu = 8$ and variance $\sigma^2 = 4$. Find:

(a) $p(X \geq 6)$	(b) $p(5 < X \leq 8)$	(c) $p(X < 9.5)$
-------------------	-----------------------	------------------

6. If X is a normal random variable with mean $\mu = 100$ and variance $\sigma^2 = 25$. Find:

(a) $p(X \geq 106)$	(b) $p(105 < X \leq 108)$	(c) $p(X < 95)$
---------------------	---------------------------	-----------------

7. If X is a normal random variable with mean $\mu = 60$ and standard deviation $\sigma = 5$. Find:

(a) $p(X \geq 65)$	(b) $p(55 < X \leq 65)$	(c) $p(50 \leq X < 55)$
--------------------	-------------------------	-------------------------

8. Scores on a test are normally distributed with a mean of 68 and a standard deviation of 8. Find the probability that a student scored:
 - (a) at least 75 on the test
 - (b) at least 75 on the test given that the student scored at least 70.
 - (c) In a group of 50 students, how many students would you expect to score between 65 and 72 on the test.

9. If X is a normally distributed variable with a mean of 24 and standard deviation of 2, find:

(a) $p(X > 28 X \geq 26)$	(b) $p(26 < X < 28 X \geq 27)$
-----------------------------	----------------------------------

10. The heights of men are normally distributed with a mean of 174 cm and a standard deviation of 6 cm. Find the probability that a man selected at random:
 - (a) is at least 170 cm tall
 - (b) is no taller than 180 cm
 - (c) is at least 178 cm given that he is at least 174 cm.

11. If X is a normal random variable with a mean of 8 and a standard deviation of 1, find the value of c , such that

(a) $p(X > c) = 0.90$	(b) $p(X \leq c) = 0.60$
-----------------------	--------------------------

12. If X is a normal random variable with a mean of 50 and a standard deviation of 5, find the value of c , such that

(a) $p(X \leq c) = 0.95$	(b) $p(X \geq c) = 0.95$	(c) $p(-c \leq X \leq c) = 0.95$
--------------------------	--------------------------	----------------------------------

- 13.** The Board of Examiners have decided that 80% of all candidates sitting the Mathematical Methods Exam will obtain a pass grade. The actual examination marks are found to be normally distributed with a mean of 45 and a standard deviation of 7. What is the lowest score a student can get on the exam to be awarded a pass grade?
- 14.** The weight of a population of women is found to be normally distributed with mean 62.5 kg. If 15% of the women weigh at least 72 kg, find the standard deviation of their weight.
- 15.** The weights of a sample of a species of small fish are normally distributed with a mean of 37grams and a standard deviation of 3.8grams. Find the percentage of fish that weigh between 34.73 and 38.93grams. Give your answer to the nearest whole number.
- 16.** The weights of the bars of chocolate produced by a machine are normally distributed with a mean of 232grams and a standard deviation of 3.6grams. Find the proportion of the bars that could be expected to weigh less than 233.91grams.
- 17.** For a normal variable, X , $\mu = 196$ and $\sigma = 4.2$. Find:
 (i) $p(X < 193.68)$ (ii) $p(X > 196.44)$ (iii) $p(193.68 < X < 196.44)$
- 18.** The circumferences of a sample of drive belts produced by a machine are normally distributed with a mean of 292cm and a standard deviation of 3.3cm. Find the percentage of the belts that have diameters between 291.69cm and 293.67cm.
- 19.** A normally distributed variable, X , has a mean of 52. $p(X < 51.15) = 0.0446$. Find the standard deviation of X .
- 20.** The lengths of the drive rods produced by a small engineering company are normally distributed with a mean of 118cm and a standard deviation of 0.3cm. Rods that have a length of more than 118.37cm are rejected. Find the percentage of the rods that are rejected. Give your answer to the nearest whole number.
- 21.** After their manufacture, the engines produced for a make of lawn mower are filled with oil by a machine that delivers an average of 270ml of oil with a standard deviation of 0.7ml. Assuming that the amounts of oil delivered are normally distributed, find the percentage of the engines that receive more than 271.12ml of oil. Give your answer to the nearest whole number.
- 22.** A sample of detergent boxes have a mean contents of 234grams with a standard deviation of 4.6grams. Find the percentage of the boxes that could be expected to contain between 232.22 and 233.87grams. Give your answer to the nearest whole number.
- 23.** A normally distributed variable, X , has a mean of 259. $p(X < 261.51) = 0.9184$. Find the standard deviation of X .
- 24.** A normally distributed variable, X , has a standard deviation of 3.9. Also, 71.37% of the data are larger than 249.8. Find the mean of X .
- 25.** The times taken by Maisie on her way to work are normally distributed with a mean of 26 minutes and a standard deviation of 2.3 minutes. Find the proportion of the days on which Maisie's trip takes longer than 28 minutes and 22 seconds.

MATHEMATICS – Higher Level (Core)

- 26.** In an experiment to determine the value of a physical constant, 100 measurements of the constant were made. The mean of these results was 138 and the standard deviation was 0.1. What is the probability that a final measurement of the constant will lie in the range 138.03 to 139.05?
- 27.** In an experiment to determine the times that production workers take to assemble an electronic testing unit, the times had a mean of 322 minutes and a standard deviation of 2.6 minutes. Find the proportion of units that will take longer than 324 minutes to assemble. Answer to 2 significant figures.
- 28.** A normally distributed variable, X , has a standard deviation of 2.6.
 $p(X < 322.68) = 0.6032$. Find the mean of X .
- 29.** The errors in an experiment to determine the temperature at which a chemical catalyst is at its most effective, were normally distributed with a mean of 274°C and a standard deviation of 1.2°C . If the experiment is repeated what is the probability that the result will be between 275°C and 276°C ?
- 30.** The weights of ball bearings produced by an engineering process have a mean of 215g with a standard deviation of 0.1g. Any bearing with a weight of 215.32g or more is rejected. The bearings are shipped in crates of 10000. Find the number of bearings that might be expected to be rejected per crate.
- 31.** If $X \sim N(\mu, 12.96)$ and $p(85.30 < X) = 0.6816$. Find μ to the nearest integer.
- 32.** At a Junior track and field meet it is found that the times taken for children aged 14 to sprint the 100 metres race are normally distributed with a mean of 15.6 seconds and standard deviation of 0.24 seconds. Find the probability that the time taken for a 14 year old at the meet to sprint the 100 metres is
- (a) i. less than 15 seconds
ii. at least 16 seconds
iii. between 15 and 16 seconds.
- (b) On one of the qualifying events, 8 children are racing. What is the probability that 6 of them will take between 15 and 16 seconds to sprint the 100 metres?
- 33.** Rods are manufactured to measure 8 cm. Experience shows that these rods are normally distributed with a mean length of 8.02 cm and a standard deviation of 0.04 cm. Each rod costs \$5.00 to make and is sold immediately if its length lies between 8.00 cm and 8.04 cm. If its length exceeds 8.04 cm it costs an extra \$1.50 to reduce its length to 8.02 cm. If its length is less than 8.00 cm it is sold as scrap metal for \$1.00.
- (a) What is the average cost per rod? (b) What is the average cost per usable rod?
- 34.** The resistance of heating elements produced are normally distributed with mean 50 ohms and standard deviation 4 ohms.
- (a) Find the probability that a randomly selected element has resistance less than 40 ohms.
- (b) i. If specifications require that acceptable elements have a resistance between 45 and 55 ohms, find the probability that a randomly selected element satisfies these specifications.

- ii. A batch containing 10 such elements is tested. What is the probability that exactly 5 of the elements satisfy the specifications?
- (c) The profit on an acceptable element, i.e., one that satisfies the specifications, is \$2.00, while unacceptable elements result in a loss of \$0.50 per element. If \$ P is the profit on a randomly selected element, find the profit made after producing 1000 elements.
- 35.** (a) Find the mean and standard deviation of the normal random variable X , given that $P(X < 50) = 0.05$ and $P(X > 80) = 0.1$.
- (b) Electrical components are mass-produced and have a measure of ‘durability’ that is normally distributed with mean μ and standard deviation 0.5. The value of μ can be adjusted at the control room. If the measure of durability of an item scores less than 5, it is classified as defective. Revenue from sales of non-defective items is \$ S per item, while revenue from defective items is set at \$ $\frac{1}{10}S$. Production cost for these components is set at \$ $\frac{1}{10}\mu S$. What is the expected profit per item when μ is set at 6?
- 36.** From one hundred first year students sitting the end-of-year Botanical Studies 101 exam, 46 of them passed while 9 were awarded a high distinction.
- (a) Assuming that the students’ scores were normally distributed, determine the mean and variance on this exam if the pass mark was 40 and the minimum score for a high distinction was 75.
- Some of the students who failed this exam were allowed to sit a ‘make-up’ exam in early January of the following year. Of those who failed, the top 50% were allowed to sit the ‘make-up’ exam.
- (b) What is the lowest possible score that a student can be awarded in order to qualify for the ‘make-up’ exam
- 37.** The heights of men in a particular country are found to be normally distributed with mean 178 cm and a standard deviation of 5 cm. A man is selected at random from this population.
- (a) Find the probability that this person is
- at least 180 cm tall.
 - between 177 cm and 180 cm tall.
- (b) Given that the person is at least 180 cm, find the probability that he is
- at least 184 cm.
 - no taller than 182 cm.
- (c) If ten such men are randomly selected, what are the chances that at least two of them are at least 176 cm?

Cumulative Standard Normal Distribution Table

$$F(x) = \frac{1}{\sqrt{2\pi}} \int_{-\infty}^x e^{-\frac{1}{2}t^2} dt$$

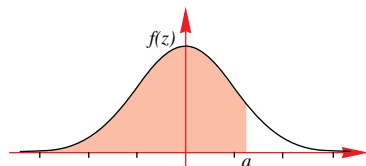

	0	0.01	0.02	0.03	0.04	0.05	0.06	0.07	0.08	0.09
0.0	0.5000	0.5040	0.5080	0.5120	0.5160	0.5199	0.5239	0.5279	0.5319	0.5359
0.1	0.5398	0.5438	0.5478	0.5517	0.5557	0.5596	0.5636	0.5675	0.5714	0.5753
0.2	0.5793	0.5832	0.5871	0.5910	0.5948	0.5987	0.6026	0.6064	0.6103	0.6141
0.3	0.6179	0.6217	0.6255	0.6293	0.6331	0.6368	0.6406	0.6443	0.6480	0.6517
0.4	0.6554	0.6591	0.6628	0.6664	0.6700	0.6736	0.6772	0.6808	0.6844	0.6879
0.5	0.6915	0.6950	0.6985	0.7019	0.7054	0.7088	0.7123	0.7157	0.7190	0.7224
0.6	0.7257	0.7291	0.7324	0.7357	0.7389	0.7422	0.7454	0.7486	0.7517	0.7549
0.7	0.7580	0.7611	0.7642	0.7673	0.7704	0.7734	0.7764	0.7794	0.7823	0.7852
0.8	0.7881	0.7910	0.7939	0.7967	0.7995	0.8023	0.8051	0.8078	0.8106	0.8133
0.9	0.8159	0.8186	0.8212	0.8238	0.8264	0.8289	0.8315	0.8340	0.8365	0.8389
1.0	0.8413	0.8438	0.8461	0.8485	0.8508	0.8531	0.8554	0.8577	0.8599	0.8621
1.1	0.8643	0.8665	0.8686	0.8708	0.8729	0.8749	0.8770	0.8790	0.8810	0.8830
1.2	0.8849	0.8869	0.8888	0.8907	0.8925	0.8944	0.8962	0.8980	0.8997	0.9015
1.3	0.9032	0.9049	0.9066	0.9082	0.9099	0.9115	0.9131	0.9147	0.9162	0.9177
1.4	0.9192	0.9207	0.9222	0.9236	0.9251	0.9265	0.9279	0.9292	0.9306	0.9319
1.5	0.9332	0.9345	0.9357	0.9370	0.9382	0.9394	0.9406	0.9418	0.9429	0.9441
1.6	0.9452	0.9463	0.9474	0.9484	0.9495	0.9505	0.9515	0.9525	0.9535	0.9545
1.7	0.9554	0.9564	0.9573	0.9582	0.9591	0.9599	0.9608	0.9616	0.9625	0.9633
1.8	0.9641	0.9649	0.9656	0.9664	0.9671	0.9678	0.9686	0.9693	0.9699	0.9706
1.9	0.9713	0.9719	0.9726	0.9732	0.9738	0.9744	0.9750	0.9756	0.9761	0.9767
2.0	0.9772	0.9778	0.9783	0.9788	0.9793	0.9798	0.9803	0.9808	0.9812	0.9817
2.1	0.9821	0.9826	0.9830	0.9834	0.9838	0.9842	0.9846	0.9850	0.9854	0.9857
2.2	0.9861	0.9864	0.9868	0.9871	0.9875	0.9878	0.9881	0.9884	0.9887	0.9890
2.3	0.9893	0.9896	0.9898	0.9901	0.9904	0.9906	0.9909	0.9911	0.9913	0.9916
2.4	0.9918	0.9920	0.9922	0.9925	0.9927	0.9929	0.9931	0.9932	0.9934	0.9936
2.5	0.9938	0.9940	0.9941	0.9943	0.9945	0.9946	0.9948	0.9949	0.9951	0.9952
2.6	0.9953	0.9955	0.9956	0.9957	0.9959	0.9960	0.9961	0.9962	0.9963	0.9964
2.7	0.9965	0.9966	0.9967	0.9968	0.9969	0.9970	0.9971	0.9972	0.9973	0.9974
2.8	0.9974	0.9975	0.9976	0.9977	0.9977	0.9978	0.9979	0.9979	0.9980	0.9981
2.9	0.9981	0.9982	0.9982	0.9983	0.9984	0.9984	0.9985	0.9985	0.9986	0.9986
3.0	0.9987	0.9987	0.9987	0.9988	0.9988	0.9989	0.9989	0.9989	0.9990	0.9990
3.1	0.9990	0.9991	0.9991	0.9991	0.9992	0.9992	0.9992	0.9992	0.9993	0.9993
3.2	0.9993	0.9993	0.9994	0.9994	0.9994	0.9994	0.9994	0.9995	0.9995	0.9995
3.3	0.9995	0.9995	0.9995	0.9996	0.9996	0.9996	0.9996	0.9996	0.9996	0.9997
3.4	0.9997	0.9997	0.9997	0.9997	0.9997	0.9997	0.9997	0.9997	0.9997	0.9998
3.5	0.9998	0.9998	0.9998	0.9998	0.9998	0.9998	0.9998	0.9998	0.9998	0.9998
3.6	0.9998	0.9998	0.9999	0.9999	0.9999	0.9999	0.9999	0.9999	0.9999	0.9999
3.7	0.9999	0.9999	0.9999	0.9999	0.9999	0.9999	0.9999	0.9999	0.9999	0.9999
3.8	0.9999	0.9999	0.9999	0.9999	0.9999	0.9999	0.9999	0.9999	0.9999	0.9999
3.9	1.0000	1.0000	1.0000	1.0000	1.0000	1.0000	1.0000	1.0000	1.0000	1.0000

REVISION SET C - PAPER 1 & PAPER 2 STYLE QUESTIONS

1. A and B are events with $P(A) = x$, $P(B) = 2x$ and $P(A \cup B) = \frac{3}{4}$. Using the expansion for $P(A \cup B)$, find x in each of the following cases:
- A and B are mutually exclusive.
 - $A \subset B$.
 - A and B are independent.
2. The annual rainfall at a certain locality is known to follow a normal distribution with mean value equal to 25 cm and standard deviation 5 cm. What is the probability that on any particular year, there will be an annual rainfall of at least 35 cm?
3. Twin sisters, Sue and Debbie, are both good maths students. Their Mathematics teacher calculated that Sue has a probability of 0.7 of getting an A at the end of the year and that Debbie has a probability of 0.6. Find the probability that:
- neither gets an A.
 - if only one gets an A, it is Sue.
4. The number of telephone calls a switchboard can handle follows a Poisson distribution. On average, it handles 120 calls per hour. The maximum number of calls per minute that can be put through it is 4. What is the probability that the switchboard will be over-taxed during any given minute?
5.
 - A School Club consists of 10 year twelve students and 5 year eleven students. A committee of five is to be selected. Give the probability distribution for the number of year eleven students on the committee.
 - Using the probability distribution table, calculate the mean and variance of the distribution.
 - Verify your answers by using the formulae for the mean and variance for the relevant distribution.
6. If $P(A) = 0.4$, $P(B) = 0.7$ and $P(A|B) = 0.3$. Find
- $P(A \cup B)$
 - $P(B|A)$
 - $P(A|A \cup B)$
7. In a certain town, 60% of the people are females and 40% are males. In an opinion poll taken, 30% of the females approved of the work done by the Town Mayor while 70% of the males approved of his work.
- What is the probability that a person chosen at random in the town will approve of the work done by the Town Mayor?
 - Also, if the person chosen did approve of his work, what is the probability that person is a female?
8.
 - Write down the number of different arrangements of the letters of the word EQUILIBRIUM.
 - One of these arrangements is chosen at random. Find the probability that:
 - the first two letters of the arrangements are consonants.
 - all the vowels are together.

MATHEMATICS – Higher Level (Core)

- 9.** The weights of a large number of children at a Kindergarden are normally distributed with mean 20 kg and standard deviation of 2 kg. Find the percentage of children with weights
- (a) less than 24 kg. (b) between 18 kg and 20 kg.
- 10.** The number of errors that a typist makes on each page that she types is known to have a Poisson distribution.
- (a) If the probability that she has typed at least one error is equal to 0.8647, what is the expected number of errors per page?
- (b) Also, what is the probability that she makes more than two errors?
- 11.** The probability that a certain darts player hits the bullseye with one dart is 0.4.
- (a) Find the probability that the player scores at most two bullseyes with 3 darts.
- (b) If the probability of scoring at least one bullseye with n darts is greater than 0.9, find the least possible value of n .
- 12.** A bag contains 4 black marbles and 4 white marbles. A sample of 4 balls is drawn at random, without replacement, from the bag
- (a) Find the probability distribution of the number of white marbles in the sample.
- (b) From the probability distribution table, find the mean and variance of the number of white marbles drawn in the sample.
- (c) If a gambler wins \$30 if 3 white marbles are drawn out, \$10 if 2 white marbles are drawn out, nothing if one white marble is drawn out, and loses \$40 if no white marbles are drawn out, what is his expected profit?
- 13.** In a Football competition, 12 teams play a series of matches to determine the best 5 (which then play a further series of ‘finals’). Before the start of this season, ‘The Moon’ newspaper ran a contest in which readers were invited to select the 5 teams which they expected to be the successful ones. The order was not important, and there was no restrictions on the number of entries per person.
- (a) Wendy wanted to submit a sufficient number of entries to ensure that one of them must be correct. How many must she submit?
- (b) In fact, nobody selected the correct 5 teams, so the prize was divided among those who selected 4 correct. How many different selections of 5 teams could have qualified for this prize?
- 14.** In the popular weekly ‘Super 66’ competition, contestants select any 6 digits in order, from the set $\{0, 1, 2, \dots, 9\}$; any digit may be selected more than once.
- (a) In how many ways may 6 different digits be arranged in order?
- (b) Hence find the probability that the winning arrangement consists of 6 different digits.
- 15.** It is known that exactly 10% of the students at Dexter High School are left-handed. If the Maths class contains 20 students, find the probability that exactly 2 of these are left-handed.
- 16.** The number of ‘E’s per line in a certain novel was found to follow a Poisson distribution with mean 5.
- (a) Find the probability that a given line contains no ‘E’s.
- (b) If the novel contains an average of 7.5 words per line, state the form of the probability distribution of the number of ‘E’s per word.
- (c) Hence state the probability that any given word contains no ‘E’s.

- 17.** Three cards are drawn (together) at random from a full pack of 52. Find the probability that at least two of these are ‘spades’.
- 18.** As a result of a certain random experiment, the events A and/or B may occur. These events are independent, and $P(A) = 0.5$; $P(B) = 0.2$.
- Find the probability that both A and B occur.
 - Find the probability that neither A nor B occurs.
 - Let X denote the random variable which counts how many of the two events occur at a given time. Thus, for example, $X = 0$ if neither A nor B occur.
Find $P(X = x)$ for $x = 0, 1, 2$.
 - Find the mean and variance of X .
- 19.** A machine is set to manufacture circular metal discs of diameter 10 cm; in fact, the diameter (in cm) of the discs it produces is a random variable Y with normal distribution, having $\mu = 10.05$ and $\sigma = 0.10$.
The demands of quality control place ‘acceptable limits’ between 9.90 cm and 10.20 cm; all discs with diameters outside this range are rejected.
- Find the proportion of discs which are rejected.
 - Given that a particular disc is accepted, find the probability that its diameter is more than 10 cm.
 - Given that a particular disc has a diameter more than 10cm, find the probability that it is accepted.
 - It is decided that too many discs are rejected by the standard. If the new rejection rate is to be 10%, find new ‘acceptable limits’, equally spaced on either side of the mean.
 - Use the fact that $Var(Y) = E(Y^2) - [E(Y)]^2$ to estimate the mean area of the discs.
- 20.** A certain cricket squad consists of 8 batsmen, 6 bowlers and a wicket keeper. A team of 11 is to be selected, consisting of 6 batsmen, 4 bowlers and the wicket keeper.
- How many different teams can be selected in this way, given that the captain (who is a batsman) must be selected in this team?
 - In any given team, the ‘batting order’ is such that the six batsmen all bat before the wicket keeper, who bats at no.7, followed by the four bowlers. How many different ‘batting order’ are possible?
- 21.** A fair coin is tossed 10 times. Find the probability that the number of ‘heads’ resulting is greater than the number of ‘tails’.
- 22.** A box contains three coins, one of which is known to be a ‘double-headed’.
- If a coin is selected at random and tossed, find the probability that it falls ‘heads’.
 - If a coin selected at random falls ‘heads’ when tossed, what is the probability that it is the double-headed coin?
- 23.** In the game of ‘Monopoly’, a player cannot start until she throws a ‘double’ with a set of two six-sided dice i.e. both dice must show the same number (from 1 to 6) uppermost when tossed.
- State the form of the probability distribution of X , the number of unsuccessful turns a player has before she manages to throw a ‘double’.
 - Find i. $P(X = 5)$ ii. $P(X \geq 5)$ iii. $P(X = 5 | X \geq 5)$

MATHEMATICS – Higher Level (Core)

- 24.** A ‘Snooker’ set consists of 22 balls of identical size; 15 are red, each of the others being a different colour. If all 22 are put into a bag, and 3 are selected at random, find the probability that:
- (a) all are red; (b) exactly one is red.
- 25.** A certain dart board consists of five concentric circles, with the respective radii r , $2r$, $3r$, $4r$, $5r$. Any dart thrown registers a score corresponding to the region in which it lands, if it misses the board altogether it does not count, and is returned to the contestant for another throw.
- (a) Show that the circles divide the board into regions whose areas are in the ratio $1 : 3 : 5 : 7 : 9$.
- (b) If Harry’s aim is quite random (i.e., he is equally likely to hit any point on the target), and X represents his score on any one shot, specify the probability distribution of X . i.e. Find $P(X = 1)$, $P(X = 2)$, \dots , $P(X = 20)$.
- (c) Find the mean and the variance of X .
- (d) If he throws three darts altogether in any one turn, find the probability that he scores a total of at least 50.
- 26.** A certain brand of soft-drink is sold in so-called ‘litre’ bottles. In fact, the amount of liquid in each bottle (in litres) is a normally distributed random variable with mean 1.005 and standard deviation 0.01.
- (a) Find the proportion of soft-drink bottles containing less than 1 litre.
- (b) If I buy four bottles, find the probability that all four contain less than 1 litre.
- (c) Find also the probability that the mean contents of the four bottles is less than 1 litre.
- 27.** For the Diploma of Transcendental Studies, a student must take six subjects, one of which must be Maths. The other available subjects are classified into two groups, A and B , which contain 4 and 5 subjects respectively. If he must select at least two of his subjects from each group, how many different subject combinations are possible?
- 28.** The letters of the word *GENERAL* are arranged at random in a row. Find the probability that:
- (a) G precedes L ;
- (b) G immediately precedes L ;
- (c) both E s occur together.
- 29.** On average, I receive two letters a day.
- (a) Assuming that the number of letters I receive per day follows a Poisson distribution, find the probability that I will receive at least two letters tomorrow.
- (b) Throughout this year, there will have been exactly 250 days on which postal deliveries are made. On how many of these could I reasonably expect to receive no letters at all?
- 30.** A bag contains 3 red and 2 black marbles. Let X be the number of marbles withdrawn (at random), one at a time without replacement, until the first black marble is drawn.
- (a) Explain why X cannot take any value greater than 4.
- (b) Specify the probability distribution of X .
- (c) Find i. $E(X)$ ii. $E(X^2)$ iii. $E(2X - 1)$

- 31.** Golfer Jock Nicholls has taken the trouble to count the number of ‘birdies’ he has scored on each of his last 100 rounds of golf:

No. of birdies	0	1	2	3	4	5	6
Frequency	13	25	30	19	8	4	1

- (a) Find the mean and standard deviation of his number of birdies per round.
 (b) Hence estimate his probability of scoring a birdie at any given one of the 18 holes.
 (c) What is the form of the theoretical probability distribution of his number of birdies per round?
 (d) Using the mean calculated in (a), find the standard deviation of this theoretical distribution.
 (e) Estimate the probability that he scores less than two birdies on any given round:
 i. using the data from the sample above;
 ii. using the theoretical probability distribution.
- 32.** (a) A pack of cards contains 4 red and 6 black cards. 4 cards are drawn, what is the probability of 2 red cards and 2 black cards if
 i. the cards are drawn without replacement?
 ii. the cards are drawn with replacement?
- (b) The number of faults in an electrical system are distributed according to the Poisson distribution. If 5% of electrical systems of this type have at least one fault, what is the percentage having exactly 1 fault?
- (c) The lengths of steel rods are normally distributed with a mean of 50 cm and a standard deviation of 0.5 cm. What is the probability of a rod having a length
 i. between 49.5 cm and 51 cm if all measurements are considered to be accurate?
 ii. of 50 cm if all measurements are correct to the nearest 0.1 cm?
- 33.** (a) The independent probabilities of three students scoring more than 10 runs in a cricket match are 0.5, 0.5 and 0.25. If the random variable, X , denotes the number of students who score more than 10 runs, find $P(X = x)$ where $x = 0, 1, 2, 3$.
- (b) In a sequence of independent trials, the probability of success is p for each trial. Let the random variable, X , denotes the number of failures before the first success occurs.
 i. Show that $P(X = x) = (1 - p)^x p$, $x = 0, 1, 2, \dots$.
 ii. Evaluate $P(X = 3)$ if $p = 0.8$.
 iii. Evaluate $p(X \leq 10 | X \leq 20)$ if $p = 0.1$.
- (c) A student is forced to guess on a multiple choice test 20% of the time. If he guesses, his probability of being correct is 0.2, while if he does not guess, his probability of being correct is 0.9.
 i. In a 50 item multiple choice test, what would be his expected number of correct items?
 ii. What is the probability that he guessed on a question, given that the answer he gave was correct?

MATHEMATICS – Higher Level (Core)

- 34.** The mean diameter of bolts from a machine can be adjusted so that the proportion of bolts greater than 1.00 cm is 0.05, and the proportion less than 0.90 cm is 0.01. Assuming the distribution of the bolt diameters to be Normal, find the mean and the standard deviation of the diameter.
- 35.** (a) A pack of cards contains 4 red and 5 black cards. A hand of 5 cards is drawn without replacement. What is the probability of there being 2 red and 3 black cards in the hand?
- (b) The distribution of errors in using an instrument to measure length in normally distributed with a mean of 1 cm and a standard deviation of 2 cm. What is the probability of a measurement
- underestimating the true length?
 - being correct to the nearest cm?
- (c) Flaws in sheets of glass are distributed according to the Poisson distribution with a mean of 1 flaw per sheet. What is the probability of finding
- a sheet with more than 1 flaw?
 - a sheet having less than 2 flaws given that it contains less than 3 flaws.
- 36.** (a) A man who works in Melbourne drives home, either along Road A or Road B. He varies his route, choosing Road A $\frac{2}{3}$ of the time. If he drives along Road A, he arrives home before 6:00 pm 90% of the time, while by the more attractive route, along Road B, he gets home before 6:00 pm 60% of the time. What is the probability
- that he gets home before 6:00 pm?
 - that he travelled along Road B, if he gets home before 6:00 pm?
- (b) A discrete random variable X may take the values 0, 1 or 2. The probability distribution of X is defined by $P(X = x) = \frac{k}{x!}$. Find
- k .
 - the mean and variance of X .
- 37.** (a) Two boxes each contain 9 balls. In box X there are four black and five white balls. In box Y there are three black and six white balls. A box is chosen at random and two balls are drawn from it without replacement. If B is the event of two black balls being drawn and C is the event of at least one black ball,
- Find
- $P(B)$
 - $P(C)$
 - $P(B \cap C)$
 - $P(B \cup C)$
 - $P(B|C)$
- (b) Suppose that 25% of the Australian population who voted in the national anthem referendum voted for ‘Waltzing Matilda’.
- What is the probability that more than 85% of a random sample of 300 of this population voted for ‘Waltzing Matilda’?
- 38.** (a) The number of aces that Raver serves while playing any match is a random variable having a Poisson distribution. If 4% of Raver’s serves are aces find the probability that in any match which Raver serves 50 times he serves
- no aces.
 - exactly two aces.
 - at least one ace.

- (b) A mathematics competition consists of fifteen multiple choice questions each having four choices with only one choice correct. Williams works through this test and he knows the correct answer to the first seven questions, but he does not know anything at all about the remaining questions, so he guesses.
Find the probability that he gets exactly 12 correct.

- 39.** Yoghurt is sold to a customer in boxes containing 10 cartons. The customer selects two cartons at random from each box without replacement. If both cartons are defective he rejects the box of cartons. If none is defective he accepts the box. If one of the cartons is defective he selects two more at random from those remaining and rejects the batch if one or both of these is defective; otherwise he accepts the batch.
What is the probability that a batch containing 3 defectives will be accepted?

- 40.** In a certain country 65% of the population support Ben's Party and 35% support Sam's Party. 90% of Ben's Party and 40% of those who support Sam's Party believe that Ben is a good leader. A member of the population is chosen at random. Given that the person believes Ben is a good leader use Bayes' Theorem to find the probability that the person supports Ben's Party.

- 41.** From 3 coins, one of which is double headed, a coin is selected at random and tossed twice.
- Let X denote the number of heads that appear. Find $P(X = x)$ for $x = 0, 1, 2$ and hence calculate the mean and variance of X .
 - If two heads appear, calculate the probability of the double headed coin being chosen.

Using the same 3 coins, a coin is selected at random then tossed 5 times.

- What is the probability of tossing exactly 2 heads?
- 42.** (a) In a population, only 1 person in 5 can perform a complex operation correctly. Find the probability of exactly 20 people performing the operation correctly from a group of 100 people.
- (b) The number of faults found in the manufacture of a particular steel pipe follows a Poisson distribution with 0.1 faults per metre of pipe. The pipe is sold in 5 m lengths. Pipes with no faults are sold for \$20, those with one flaw are sold as 'seconds' at \$10, while those with more than one fault are rejected. It costs \$1 per metre to produce the pipe. What is the expected profit per metre (to the nearest cent)?

Without performing the calculation, would your answer for the profit per metre change if the pipe was sold in 10 m lengths for \$40, if there are no faults, \$20 for 'second', the remainder being rejected. Give a reason for your answer.

- 43.** (a) In a test match, the probability of New Zealand defeating the Australian cricket team is 0.2, of a draw is 0.3 and of an Australian win is 0.5. For a three match test series, what is the probability of
- New Zealand winning the first two matches?
 - New Zealand winning two matches?
 - Australia winning two matches, the other being drawn?
 - Australia winning the series (that is, winning more matches than New Zealand)?

MATHEMATICS – Higher Level (Core)

- (b) From a population of 50 people of which 10 are classified as aliens, a sample of 25 people is chosen at random. Let X represent the number of aliens in the sample. Calculate the mean and standard deviation for X .
- 44.** Of 5 cards, 3 are labelled with a 1, the others with a 2. Three cards are drawn at random from the five cards, observed, then returned to the pack. This process is repeated a second time. If X denotes the number of times two 1's and a 2 are drawn,
- Find the probability of two 1's and a 2 on the first draw.
 - Find $P(X = x)$, for $x = 0, 1, 2$ for the two draws.
 - Calculate the mean and variance of X .
 - Calculate $P(X > 1 | X > 0)$.
- 45.** (a) Urn X contains 4 red and 2 green balls and urn Y contains 5 red and 1 green ball. An urn is chosen at random and 2 balls are drawn from it without replacement. If A is the event of two red balls being drawn and B is the event of at least one red ball being drawn from urn X, find
- $P(A)$
 - $P(B)$
 - $P(A \cap B)$
 - $P(A \cup B)$
 - $P(A|B)$
- (b) In $x\%$ of a day, the probability of a machine producing a defective article is p while for the rest of the day the probability of a defective article is q . If one item is chosen at random at the end of the day, what is the probability that it is defective?
- 46.** The cross-sectional area of a rod produced by a machine is normally distributed with a standard deviation of σ cm² and a mean of 4.0 cm². If the proportion of rods with cross-sectional area of less than 3.0 cm² is 0.4, evaluate σ . If all rods with cross-sectional area of less than 3.0 cm² are rejected, what is the probability of an accepted rod having a cross-sectional area greater than 5 cm²?
- 47.** The I.Q. of a member of a population is determined from a scale which is normally distributed. The Stanford-Binet I.Q. scale has a mean of 100 and standard deviation of 16. Using this scale, find the
- probability that a person chosen at random has an I.Q. between 116 and 132.
 - I.Q. of a person who is in the top 1% on the I.Q. scale.
 - I.Q. of a person on the Stanford-Binet scale if their I.Q. on a scale which has a mean of 100 and standard deviation of 15 is given as 135.
 - I.Q. of a person who is in the top 1% of those people who have an I.Q. greater than 100 on the Stanford-Binet scale.
- 48.** Let A and B be events such that $P(A) = \frac{1}{3}$, $P(B) = \frac{1}{4}$ and $P(A \cup B) = \frac{5}{12}$.
- Find $P(A|B)$
 - $P(A|B')$
 - Are A and B independent? Why?
- 49.** A random sample of six balls is selected without replacement from a box containing five white and four black balls. Let W denote the number of white balls in the sample.
- List the possible values of W .
 - What is the mean of W ?
 - Find the probability that W is greater than its mean.

- 50.** The random variable X with sample space $\{1, 2, 3\}$ is such that

$$P(X = 1) = b, P(X = 2) = 3a - 3b, P(X = 3) = 2b$$
- Express $E(X)$ in terms of a and b .
 - What values may a and b take?
- 51.** Suppose that X has a Poisson distribution with non-zero mean and

$$P(X = 2) = 2P(X = 1)$$
- Find the mean of X
 - Find $P(X \geq 2)$, correct to four decimal places.
- 52.** A particular device is made by two manufacturers, ACME and EMCO. Any device produced by ACME is such that at any attempt the device operates with probability 0.9 independent of previous attempts.
- Find the probability that a device made by ACME operates exactly twice before failing.
 EMCO produces a cheaper version; any device produced by EMCO is such that at any attempt the device operates with a probability of 0.6 independent of previous attempts. A batch of five of these devices contains four made by ACME and one made by EMCO. One device is selected at random from the batch of five.
 - If the selected device operates exactly twice before failing, find the probability that it is the device produced by EMCO.
- 53.** A machine produces 800 items each day, which are packed 20 to a box. It is known that, on average, one per cent of items produced is defective.
- (a) A box is selected at random. Find, correct to three decimal places, the probability that it contains more than one defective item.
 From the day's production of 40 boxes, four boxes are selected at random. All items in these four boxes are inspected. If none of the four boxes is found to contain more than one defective item, the day's production is passed as satisfactory. Otherwise, the entire day's production is inspected.
- (b)
- Find, correct to three decimal places, the probability that the day's production is passed as satisfactory after the four boxes are inspected.
 - Find, correct to the nearest integer, the mean number of items inspected.
 - If all defective items found are replaced with good items, find, correct to three decimal places, the expected proportion of items which are defective after this inspection-and-replacement process.
- 54.** A fruitgrower produces peaches whose weights are normally distributed with a mean of 180 g and a standard deviation of 20 g.
 Peaches whose weights exceed 200 g are sold to canneries yielding a profit of \$0.40 per peach. Peaches whose weights are between 150 g and 200 g are sold to wholesale markets at a profit of \$0.20 per peach. Peaches whose weights are less than 150 g are sold for jam at a profit of \$0.10 per peach. Find the
- percentage of peaches produced that are sold to canneries;
 - percentage of peaches produced that are sold to wholesale markets;
 - the mean profit per peach.
- 55.** A manufacturer produces metal sheets of dimensions $2\text{m} \times 1\text{m}$ which may have defects of two types. Each of the two types of defect occurs independently according to a Poisson distribution.
 Defects of type A occur at the rate of 0.1 per square metre, while defects of type B occur at the rate of 0.04 per square metre.

MATHEMATICS – Higher Level (Core)

- (a) Find the probability, correct to three decimal places, that a sheet contains
- at least one defect of type B.
 - no defects of either type.
 - no defects of type B and at least one of type A.
- (b) Sheets with any defects of type B must be scrapped and so result in a loss of \$20. Sheets with no defects of either type yield a profit of \$11. Sheets with no defects of type B but at least one of type A yield a profit of \$5. Find the mean profit per sheet (correct to the nearest cent).

56. Consider the following set of data:

12, 4, 9, 10, 12, 13, 15, 11, 12, 15, 14, 8, 9, 10, 12, 9, 10, 16, 14, 13, 12, 15, 9, 10, 12

- (a) Construct
- a frequency polygon.
 - cummulative frequency polygon.
- (b) Calculate
- the mean
 - the standard deviation.
- (c)
- Construct a box-plot.
 - Determine the median and the mode.
 - Calculate the interquartile range

57. In order to fill unreserved seats in its planes, an airline sells tickets at half the normal economy class fare to people who purchase tickets at the airport within 30 minutes of the departure of a flight. However, experience shows that there is only a probability of 0.4 of getting such a ticket for any particular flight.

The airline has hourly flights to Northport and a man who wishes to do business in Northport has the choice of flying on the 10 am, 11 am or 12 noon flights. His travelling procedure is to try to purchase a half-price ticket on the 10 am flight and, if unsuccessful, to wait and try to purchase a half-price ticket on the 11 am flight. If he is again unsuccessful he travels on the 12 noon flight with a full fare first class ticket which he knows will always be available. The economy class fare is \$200 and the first class fare is \$300.

- (a) Find the probability that the man catches
- the 11 am flight;
 - the 12 noon flight.
- (b) If the man can earn \$ Q for every hour that he is in Northport, express as a function of Q the mean cost to him of his travelling procedure.
- (c) For what values of Q would the man expect to earn more money, after allowing for his travelling costs, if he made no attempt to purchase a half-price ticket and travelled with a full fare economy class ticket on the 10 am flight?

58. The random variable X has a Poisson distribution with mean λ .

- (a) Show that $P(X \text{ is even}) = e^{-\lambda} \left(1 + \frac{\lambda^2}{2!} + \frac{\lambda^4}{4!} + \dots \right)$

and obtain a similar expression for $P(X \text{ is odd})$. *Note that 0 is even.*

- (b) Use the results of (a) to show that

$$P(X \text{ is even}) - P(X \text{ is odd}) = e^{-2\lambda}$$

and hence express $P(X \text{ is even})$ in terms of $e^{-2\lambda}$.

- (c) Suppose that the actual value of X cannot be observed, but only whether it is even or odd. If 553 out of 1000 X -values are found to be even, find an approximate value of λ .

18.1 QUANTITATIVE MEASURE

18.1.1 FUNCTIONAL DEPENDENCE

The notion of functional dependence of a function $f(x)$ on the variable x has been dealt with in Chapter 5. However, apart from this algebraic representation, sometimes it is desirable to describe a graphical representation using a qualitative rather than quantitative description. In doing so, there are a number of key words that are often used.

Words to be kept in mind are:

Rate of change (slow, fast, zero)	Increasing, decreasing
Positive, negative	Maximum, minimum
Average	Instantaneous
Stationary	Initial, final
Continuous, discontinuous	Range, domain

Such terms enable us to describe many situations that are presented in graphical form. There is one crucial point to be careful of when describing the graphical representation of a given situation. Graphs that look identical could very well be describing completely different scenarios. Not only must you consider the behaviour (shape) of the graph itself, but also take into account the variables involved.

Consider the two graphs below. Although identical in form, they tell two completely different stories. We describe what happens in the first five minutes of motion:

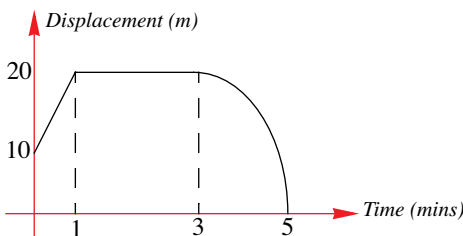

An object is moving in such a way that its displacement is increasing at a constant rate, that is, the object maintains a constant velocity (or zero acceleration) for the first minute. During the next two minutes the object remains stationary, that is, it maintains its displacement of 20 metres (meaning that it doesn't move any further from its starting position). Finally the particle returns to the origin.

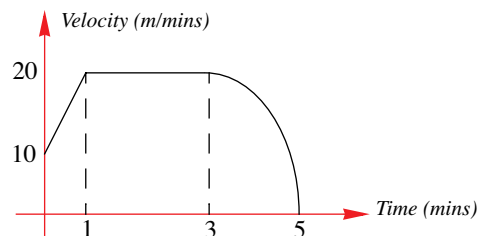

An object is moving at 10 m/min and keeps increasing its velocity at a constant rate until it reaches a velocity of 20 m/min, that is, it maintains a constant acceleration for the first minute. During the next two minutes the object is moving at a constant velocity of 20 m/min (meaning that it is moving further away from its starting position). Finally, the particle slows to rest, far from the origin.

Although the shape of the graphs are identical, two completely different situations have been described!

18.1.2 QUANTITATIVE ASPECTS OF CHANGE

When dealing with the issue of rates of change, we need to consider two types of rates:

1. that of the **average rate** of change and
2. that of the **instantaneous rate** of change.

We start by considering the first of these terms, the average, and then see how the second, the instantaneous rate, is related to the first.

18.1.3 AVERAGE RATE OF CHANGE.

The average rate of change can be best described as an ‘overview’ of the effect that one variable (the independent variable) has on a second variable (the dependent variable). Consider the graph below, we can describe the change in the y -values (relative to the change in the x -values) as follows:

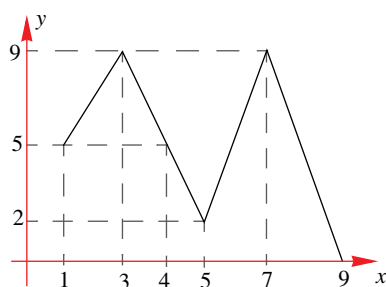

For $x \in [1, 3]$:

There is a **constant** increase from $y = 5$ to $y = 9$ as x increases from 1 to 3. So that an increase of 2 units in x has produced an increase of 4 units in y .

We say that the **average rate** of change of y with respect to x is $\frac{4}{2} = 2$

For $x \in [1, 4]$:

This time, the overall change in y is 0.

That is, although y increases from 5 to 9, it then decreases back to 5. So from its initial value of 5, because it is still at 5 as x increases from 1 to 4, the overall change in y is 0. This time the average rate

of change is $\frac{0}{3} = 0$.

For $x \in [1, 5]$:

As x now increases from 1 to 5 we observe that there is an overall decrease in the value of y , i.e., there is an overall decrease of 3 units ($y: 5 \rightarrow 9 \rightarrow 5 \rightarrow 2$). In this instance we say that

the average rate of change is $-\frac{3}{4} = -0.75$.

Notice that we have included a negative sign to indicate that there was an overall decrease in the y values (as x has increased by 4).

Similarly for the rest of the graph. Note that we need not start at $x = 1$. We could just as easily have found the change in y for $x \in [3, 5]$. Here, the average rate of change is $-\frac{7}{2} = -3.5$.

The question then remains, is there a simple way to find these average rates of change and will it work for the case where we have non-linear sections? As we shall see in the next sections, the answer is ‘yes’.

18.1.4 DETERMINING THE AVERAGE RATE OF CHANGE

To find the average rate of change in y it is necessary to have an initial point and an end point, as x increases from x_1 to x_2 .

At A $x = x_1, y = y_1$ and at B $x = x_2, y = y_2$.

To obtain a numerical value, we find the gradient of the straight line joining these two points.

Average rate of change from A to B = gradient from A to B

$$= \frac{y_2 - y_1}{x_2 - x_1}$$

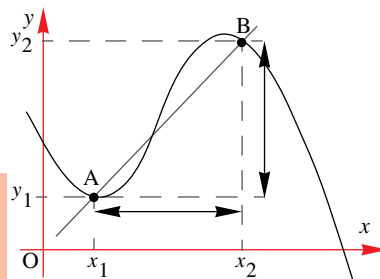

EXAMPLE 18.1

For each of the graphs below, find the average rate of change of y with respect to x over the interval specified (i.e., over the domain L).

(a)

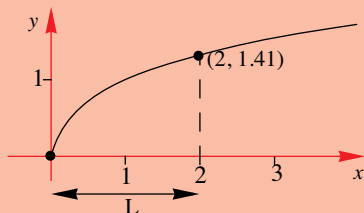

(b)

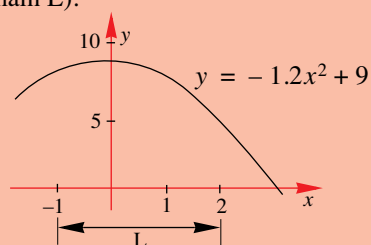

S
O
L
I
T
I
O
N

(a) For this case we have the 'starting point' at the origin (with coordinates $(0,0)$) and the 'end' point with coordinates $(2,1.41)$.

This means that the average rate of change of y with respect to x , over the domain L is

$$\text{given by } \frac{y_2 - y_1}{x_2 - x_1} = \frac{1.41 - 0}{2 - 0} = 0.705.$$

(b) This time we will need to first determine the coordinates of the extreme points:

For $x = -1$, $y = -1.2 \times (-1)^2 + 9 = 7.8$ and for $x = 2$, $y = -1.2 \times (2)^2 + 9 = 4.2$.

$$\text{Therefore, the average rate of change is equal to } \frac{y_2 - y_1}{x_2 - x_1} = \frac{4.2 - 7.8}{2 - (-1)} = -1.2.$$

It is not always necessary to have a graph in order to find the average rate of change. Often we are given information in the form of a table.

EXAMPLE 18.2

The table below shows the number of bacteria, N , present in an enclosed environment. Find the average growth rate of the population size over the first 4 hours

Time (hrs)	0	1	2	3	4	5	6	7	9
N	30	36	43	52	62	75	90	107	129

Solution

This time we need to consider the time interval $t = 0$ to $t = 4$. From the table we observe that the coordinates corresponding to these values are; $(0,30)$ and $(4,62)$.

Therefore, the average rate of growth of the number of bacteria over the first 4 hours is equal to $\frac{62 - 30}{4 - 0} = \frac{32}{4} = 8$.

This means that during the first 4 hours, the number of bacteria was increasing (on average) at a rate of 8 every hour.

Notice that in the 1st hour, the average rate was $\frac{36 - 30}{1 - 0} = \frac{6}{1} = 6 (< 8)$, whereas in the 4th hour

the average rate of increase was $\frac{62 - 52}{4 - 3} = \frac{10}{1} = 10 (> 8)$.

18.1.5 VELOCITY AS A MEASURE OF THE RATE OF CHANGE OF DISPLACEMENT

Consider a marble that is allowed to free fall from a height of 2 metres (see diagram). As the marble is falling, photographs are taken of its fall at regular intervals of 0.2 second.

From its motion, we can tell that the rate at which the marble is falling is increasing (i.e., its velocity is increasing).

What is its average velocity over the first 0.6 second?

Reading from the diagram, we see that the marble has fallen a total distance of 1.75 (approximately), therefore, the average velocity v_{ave} of the marble, given by the rate at which its displacement increases (or decreases), is given by

$$v_{ave} = \frac{1.75 - 0}{0.6 - 0} \approx 2.92 \text{ m/sec}$$

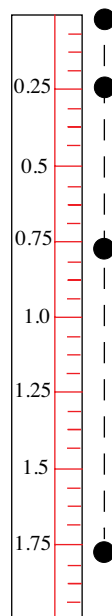

EXAMPLE 18.3

The displacement, x m, of an object, t seconds after it is dropped from the roof of a building is given by $x = 4.9t^2$ m.

- What is the object's displacement after 4 seconds?
- What is the average velocity of the object over the first 4 seconds of its motion?

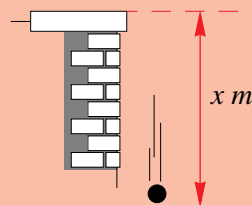

Solution

- After 4 seconds of free fall, the object's displacement will be $4.9(4)^2 = 78.4$ m. We obtained this result by substituting the value of $t = 4$ into the equation for the displacement $x = 4.9t^2$.
- The average velocity is given by the average rate of change of displacement, x m, with respect to the time t seconds.

Once we have the starting position and the end position we can determine the average

$$\text{velocity using: } v_{ave} = \frac{x_2 - x_1}{t_2 - t_1} = \frac{78.4 - 0}{4 - 0} = 19.6.$$

That is, the object's average velocity over the first 4 seconds is 19.6 m/s.

EXAMPLE 18.4

The concentration of a drug, in milligrams per millilitre, in a patient's bloodstream, t hours after an injection is approximately modelled by the function

$$t \mapsto \frac{2t}{8 + t^3}, t \geq 0.$$

Find the average rate of change in the concentration of the drug present in a patient's bloodstream; (a) during the first hour.

(b) during the first two hours.

(c) during the period $t = 2$ to $t = 4$.

Solution

To help us visualise the behaviour of this function we will make use of the TI-83. Begin by introducing the variable C , to denote the concentration of the drug in the

patient's bloodstream t hours after it is administered. So that $C(t) = \frac{2t}{8 + t^3}, t \geq 0$.

(a) Initially the concentration is 0 milligrams per millilitre, the concentration after 1hr is given by

$$C(1) = \frac{2 \times 1}{8 + 1^3} = \frac{2}{9} \approx 0.22.$$

Therefore, the average rate of change in concentration (C_{ave}) during

the first hour is given by $C_{ave} = \frac{0.22 - 0}{1 - 0} = 0.22$.

Note: the units are $mg/ml/hr$.

(b) The concentration 2 hours after the drug has been administered is $C(2) = \frac{2 \times 2}{8 + 2^3} = 0.25$.

That is, 0.25 mg/ml .

Therefore, the average rate of change in concentration with respect to time is

$$C_{ave} = \frac{0.25 - 0}{2 - 0} = 0.125.$$

Notice that although the concentration has increased (compared to the concentration after 1 hour), the rate of change in the concentration has actually decreased!

This should be evident from the graph of $C(t)$ versus t .

The slope of the straight line from the origin to A(1, 0.22), m_{OA} , is

greater than the slope from the origin O to the point B(2, 0.25), m_{OB} .

That is $m_{OA} > m_{OB}$.

(c) The average rate of change in concentration from $t = 2$ to $t = 4$ is given by $\frac{C(4) - C(2)}{4 - 2}$.

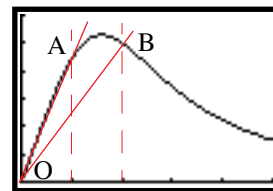
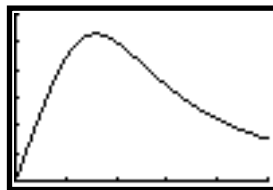

$$\text{Now, } \frac{C(4) - C(2)}{4 - 2} = \frac{\frac{2 \times 4}{8 + 4^3} - 0.250}{4 - 2} \approx \frac{0.111 - 0.250}{2} = -0.0694$$

Therefore, the average rate of change of concentration is -0.070 mg/ml/hr .

Meaning that the overall amount of drug in the patient's bloodstream is decreasing during the time interval $2 \leq t \leq 4$.

EXERCISES 18.1

1. For each of the following graphs determine the average rate of change over the specified domain.

(a) $x \in [4, 8]$

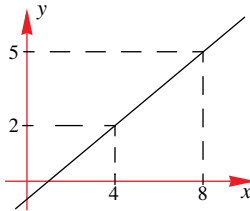

(b) $x \in [-b, 3b]$

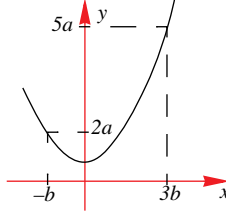

(c) $x \in [-2, 2]$

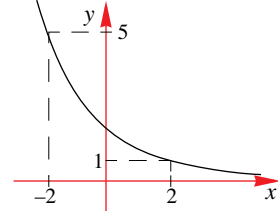

(d) $x \in [-3, 2]$

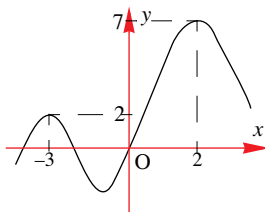

(e) $x \in [-2, 6]$

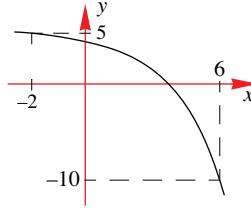

(f) $x \in [-1, 1]$

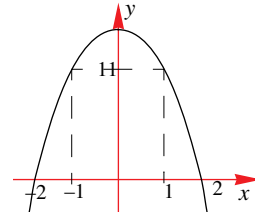

2. For each of the following functions, find the average rate of change over the given domain.

(a) $x \mapsto x^2 + 2x - 1, x \in [0, 2]$

(b) $x \mapsto \sqrt{x+1}, x \in [3, 8]$

(c) $x \mapsto 10 - \frac{1}{\sqrt{x}}, x \in [2, 20]$

(d) $x \mapsto \frac{x}{x+1}, x \in [0.1, 1.1]$

(e) $x \mapsto \frac{1}{1+x^2} - 1, x \in [0, 100]$

(f) $x \mapsto x\sqrt{400-x}, x \in [300, 400]$

(g) $x \mapsto 2^x, x \in [0, 5]$

(h) $x \mapsto (x-1)(x+3), x \in [-3, 2]$

3. The displacement of an object, t seconds into its motion is given by the equation,

$$s(t) = t^3 + 3t^2 + 2t, t \geq 0.$$

Find the average rate of change of displacement during

- (a) the first second.
- (b) the first 4 seconds.
- (c) the interval when $t = 1$ to $t = 1 + h$.

4. The distance s metres that a particle has moved in t seconds is given by the function $s = 4t + 2t^2, t \geq 0$. Find the particle's average speed over the first 4 seconds.

5. The distance s metres that a particle has moved in t seconds is given by the function $s = 4t + 2t^2, t \geq 0$. Find the particle's average speed during the time interval from when $t = 1$ to $t = 1 + h$.

6. The temperature $T^\circ\text{C}$ of food placed inside cold storage is modelled by the equation

$$T = \frac{720}{t^2 + 2t + 25} \text{ where } t \text{ is measured in hours.}$$

Find the average rate of change of the temperature, $T^\circ\text{C}$, with respect to the time, t hours, during the first 2 hours that the food is placed in the cold storage.

7. The volume of water in a hemispherical bowl of radius r is given by $V = \frac{1}{3}\pi h^2(3r - h)$,

where h is the height of the water surface inside the bowl. For the case where r is 20 cm,

- (a) find the average rate of increase in the amount of water inside the bowl with respect to its height, h cm, as the water level rises from 2 cm to 5 cm.
 (b) Find the average rate of increase in the amount of water inside the bowl with respect to its height, h cm, as the water level rises by
 i. 1 cm ii. 0.1 cm iii. 0.01 cm
8. An amount of money is placed in a bank and is accumulating interest on a daily basis. The table below shows the amount of money in the savings account over a period of 600 days.

t (days)	100	200	300	400	500	600	700
$\$D/\text{day}$	1600	1709	1823	1942	2065	2194	2328

- (a) Plot the graph of $\$D$ versus t (days).
 (b) Find the average rate of change in the amount in the account during the period of 100 days to 300 days.
9. The temperature of coffee since it was poured into a cup was recorded and tabulated below.

t min	0	2	4	6	9
$T^\circ\text{C}$	60	50	30	10	5



- (a) Plot these points on a set of axes that show the relationship between the temperature of the coffee and the time it has been left in the cup.
 (b) Find the average rate of change of temperature of the coffee over the first 4 minutes.
 (c) Over what period of time is the coffee cooling the most rapidly?
10. The displacement, d metres, of an object, t seconds after it was set in motion is described by the equation

$$d = 4t + 5t^2, \text{ where } t \geq 0.$$

- (a) Find the distance that the object travels in the first 2 seconds of its motion.
 (b) Find the average rate of change of distance with respect to time undergone by the object over the first 2 seconds of its motion.
 (c) What quantity is being measured when determining the average rate of change of distance with respect to time?
 (d) How far does the object travel during the 5th second of motion?
 (e) Find the object's average speed during the 5th second.

- 11.** A person invested \$1000 and estimates that on average, the investment will increase each year by 16% of its value at the beginning of the year.
- Calculate the value of the investment at the end of each of the first 5 years.
 - Find the average rate at which the investment has grown over the first 5 years.

18.2 QUALITATIVE MEASURE

18.2.1 QUALITATIVE ASPECTS OF CHANGE

Apart from quantitative measures (i.e., providing numerical values), it is also important to be able to provide qualitative descriptions of the behaviour of graphs. In doing so, many of the key words mentioned at the start of this chapter should be referred to.

18.2.2 DESCRIBING THE BEHAVIOUR OF A GRAPH

Consider the graph shown:

In both Section A and Section B, the gradients of the lines are positive. However, the gradient of the straight line in section B is steeper than that of the line in Section A. We can then say that over Section B the graph is increasing at a faster rate than it is over Section A.

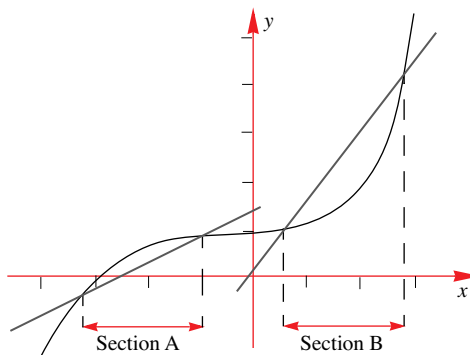

In fact, if we were able to walk along this curve, from left to right, we could describe our ‘journey’ as follows:

As we walk from the left hand side and towards that part of the graph that lies above Section A, the **function is increasing**, i.e., as the values of x increase, so too do the values of y . As the values of x approach 0 (from the left side of the y -axis) the rate at which the function is increasing is slowing down. That is, I do not need to make as much effort to move as I get closer to the y -axis. Even though the function is still increasing (as we are getting closer to the y -axis), we then have that the rate of change of the function is in fact decreasing! Actually, by the stage when we have reached the y -axis we could almost say that the **function remains stationary**, i.e., it has stopped increasing. In this instance, we would say that the **rate of change of the function is zero**. As we pass the y -axis and keep moving along the curve we find it more difficult to walk along the curve. That is, the effort that we need to make to keep walking is increasing. In this instance the function is increasing but so too is the rate at which it is increasing.

18.2.3 PRODUCING A GRAPH FROM A PHYSICAL SITUATION

In this section we will concentrate on producing a graph to describe the behaviour of the flow of liquid into a container. The importance of such problems is that they enable us to describe how changing one variable will affect a second (related) variable. That is, the effect the independent variable has on the dependent variable. One way to do this is by increasing the independent variable (usually x) and observing the change in the dependent variable (usually y).

EXAMPLE 18.5

A cylindrical vase is placed under a tap and water is allowed to flow into it at a constant rate. Provide a graphical representation of the relationship between the volume of water in the vase and

- (a) the time for which water flows into the vase.
 (b) the level of water.

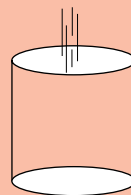
Solution

- (a) The independent variable in this case is time, t seconds. Consider the volume of water, $V \text{ cm}^3$, that flows into the vase in equal time intervals (of 2 seconds say). In these equal time intervals we have equal amounts of water flowing into the vase. For example, if 10 cm^3 of water flows into the vase every 2 seconds, we could produce the following table of values:

t seconds	0	2	4	6	...
$V \text{ cm}^3$	0	10	20	30	...

Based on the results of this table we can produce a graph of $V \text{ cm}^3$ versus t seconds:

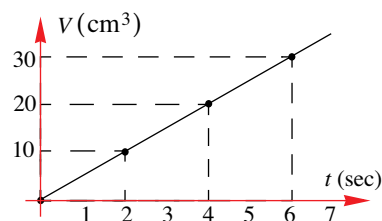

- (b) To see how the volume changes with respect to the level of water, we use a different approach— this time we consider a ‘frame-by-frame’ sequence of the vase as it is filled.

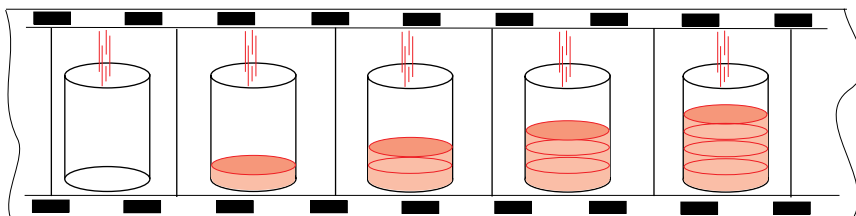

From our ‘snap-shots’, we see that for equal heights, equal amounts of water flow into the vase. So that every time the water level increases by 1 cm, the volume increases by 8 cm^3 .

This would imply that the relationship between the volume, $V \text{ cm}^3$ of water in the vase and the level of water, $h \text{ cm}$, is linear.

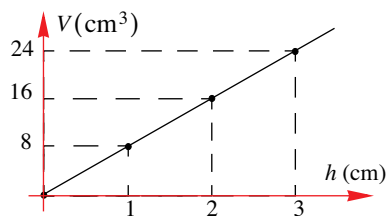
EXAMPLE 18.5

Sketch a graph showing the relationship between the level of water in a flask and the time for which water has been flowing into the flask.

Solution

Let the level of water in the flask be denoted by h cm and the time for which water has been flowing be denoted by t seconds. Again, we use our ‘frame-by-frame’ approach:

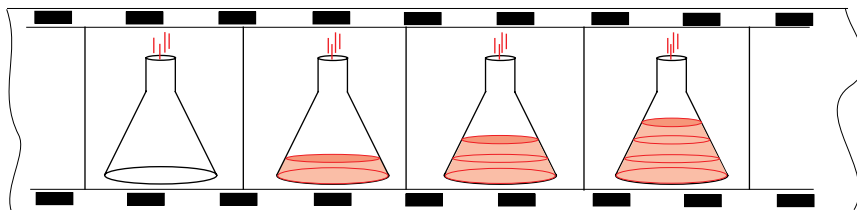

As we consider equal time intervals we see that the same amount of water will flow into the flask during each of these time intervals. However, because the flask becomes narrower as the level rises, then (because we still have the same volume of water flowing into the flask), the height of the space occupied by these equal volumes of water must increase at a faster rate than it had for the ‘cone’ section. A cross sectional view of the flask (shown above) shows this more clearly.

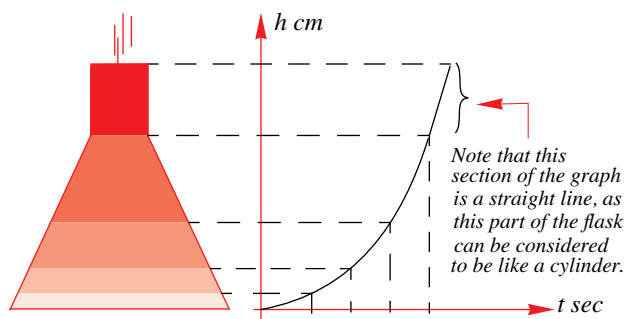

EXERCISES 18.2

1. (a) The cross section of a basin, shown in Figure A, is being filled by water flowing at a constant rate.

Sketch a graph of the relationship between the level of water, h cm, and the time, t sec, that water has been flowing.

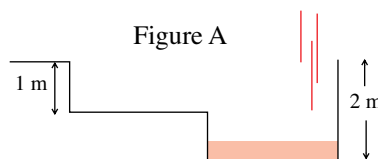

- (b) The cross section of a second basin is shown in Figure B. Water is flowing into this basin at the same rate as in (a).

Sketch a graph of the relationship between the level of water, h cm, and the time, t sec, that water has been flowing for this basin.

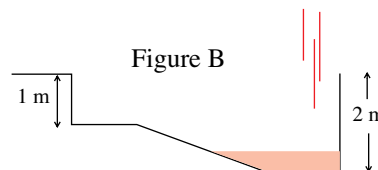

2. For each of the following bottles, sketch the graph that would show the relationship between the level of water, h cm, and the volume of water, V cm³ in the bottle. That is, sketch a graph of h versus V .

You may assume that water is flowing into each bottle at a constant rate.

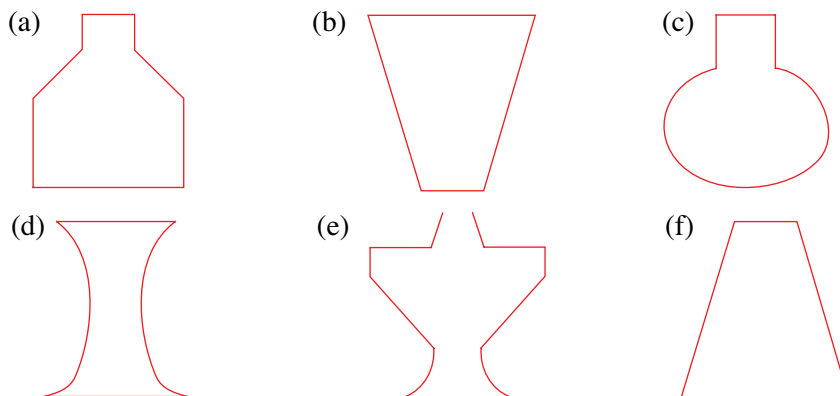

18.3 INSTANTANEOUS RATE OF CHANGE

18.3.1 INFORMAL IDEA OF LIMITS

As already discussed, the average rate of change between two points on a curve is determined by finding the gradient of the straight line joining these two points. However we often need to find the rate of change at a particular instant, and so the method used for finding the average rate of change is no longer appropriate. However, it does provide the foundation that leads to obtaining the instantaneous rate of change. We refine our definition of the average rate of change to incorporate the notion of the instantaneous rate of change. The basic argument revolves around the notion of magnifying near the point where we wish to find the instantaneous rate of change, that is, by repeatedly ‘closing in’ on a section of a curve. This will give the impression that over a very small section, the curve can be approximated by a straight line. Finding the gradient of that straight line will provide us with a very good approximation of the rate of change of the curve (over the small region under investigation). To obtain the exact rate of change at a particular point on the curve we will then need to use a **limiting** approach.

The process used to determine the rate of change at A is carried out as follows:

1. Start by drawing a secant from A to B, where B is chosen to be close to A. This will provide a reasonable first approximation for the rate of change at A. Then, to obtain a better approximation we move point B closer to point A.
2. Next, **zoom-in** towards point A, again. We move point B closer to point A, whereby a better measure for the rate of change at point A is now obtained. We then repeat step 2, i.e., move B closer to A and zoom in, move point B closer to A and zoom in, and so on.
3. Finally, the zooming-in process has reached the stage whereby the secant is now virtually lying on the curve at A. In fact the secant is now the tangent to the curve at the point A.

Using the process of repeatedly zooming-in to **converge** on a particular region lies at the heart of the **limiting process**. Once we have understood the concepts behind the limiting process, we can move on to the more formal aspect of limits. However, apart from an informal treatment of limits, work on limits is beyond the scope of the core work in HL mathematics.

We now provide a ‘visual’ representation of steps 1. to 3. described above.

As we magnify, and move point B closer to point A the secant from A to B becomes the tangent at A:

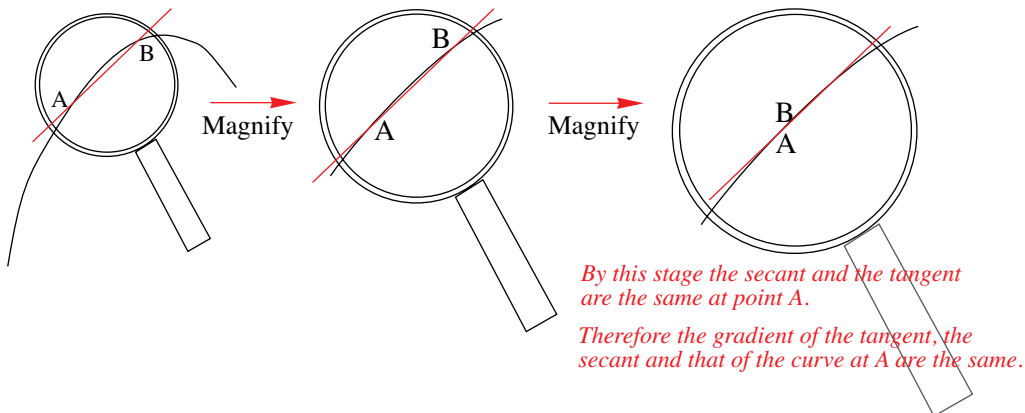

We now investigate this limiting process further through a number of examples. We will still maintain an informal approach to determining limits, but at the same time we will steer our work on limits towards the fundamentals behind the ideas in Chapter 19 – Differential calculus.

EXAMPLE 18.6

An object moves along a straight line. Its position, x metres (from a fixed point O), at time t seconds is given by $x(t) = t - \frac{1}{4}t^2, t \geq 0$. Determine

- (a) its average velocity over the interval from $t = 1$ to $t = 2$
 - (b) its average velocity over the interval $t = 1$ to $t = 1.5$
 - (c) its average velocity over the interval $t = 1$ to $t = 1.1$
 - (d) its average velocity over the interval $t = 1$ to $t = 1 + h$, where h is small.
- How can the last result help us determine the object’s velocity at $t = 1$?

Solution

- (a) The average velocity over the required second (from $t = 1$ to $t = 2$) is found by looking at the slope of the secant joining those two points on the graph of $x(t)$.

At $t = 2$, we have $x(2) = 2 - \frac{1}{4}(2)^2 = 1$, and at $t = 1$, $x(1) = 1 - \frac{1}{4}(1)^2 = \frac{3}{4}$.

$$\begin{aligned} \text{Therefore, we have that } v_{ave} &= \frac{x(2) - x(1)}{2 - 1} \\ &= \frac{1 - 0.75}{1} \\ &= 0.25 \end{aligned}$$

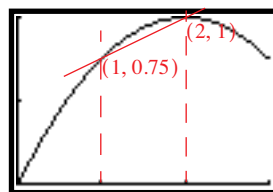

Therefore, the average velocity over the second is 0.75m/s.

- (b) For $t = 1$ to $t = 1.5$ we have, $v_{ave} = \frac{x(1.5) - x(1)}{1.5 - 1} = \frac{(1.5 - 0.25 \times 1.5^2) - 0.75}{0.5} = 0.375$
- (c) Similarly, for $t = 1$ to $t = 1.1$, we have $v_{ave} = \frac{x(1.1) - x(1)}{1.1 - 1} = 0.475$
- (d) We are now in a position to determine the average rate over the interval $t = 1$ to $t = 1 + h$. The average velocity is given by $v_{ave} = \frac{x(1 + h) - x(1)}{1 + h - 1}$

$$\begin{aligned} \text{Now, } x(1+h) &= (1+h) - 0.25(1+h)^2 = 1+h - 0.25(1+2h+h^2) \\ &= 0.75 + 0.5h - 0.25h^2 \end{aligned}$$

$$\begin{aligned} \text{Therefore, } v_{ave} &= \frac{0.75 + 0.5h - 0.25h^2 - 0.75}{1+h-1} = \frac{0.5h - 0.25h^2}{h} \\ &= \frac{h(0.5 - 0.25h)}{h} \\ &= 0.5 - 0.25h, \quad h \neq 0 \end{aligned}$$

Notice that for ii., (i.e., $t = 1$ to $t = 1.5$) $h = 0.5$, so that substituting $h = 0.5$ into this equation we have, $v_{ave} = 0.5 - 0.25(0.5) = 0.375$, providing the same result as before.

We can set up a table of values and from it determine what happens as we decrease the time difference.

h	v_{ave}
0.1	0.475
0.01	0.4975
0.001	0.4999

We notice that as h becomes very small, the average rate of change from $t = 1$ to $t = 1 + h$ becomes the instantaneous rate of change at $t = 1$! This is because we are zooming in onto the point where $t = 1$.

This means that the rate of change at $t = 1$ ($h = 0$) would therefore be 0.5 m/s. So that the particle would have a velocity of 0.5 m/s after 1 second of motion.

EXAMPLE 18.7

For the graph with equation $f: x \mapsto (x+2)(x-1)(x-4)$,

- Find the average rate of change of f over the interval $[-1, 2]$.
- Find the rate of change of f , where $x = 4$.

S
o
l
u
t
i
o
n

- We first find the coordinates of the end points for the interval $[-1, 2]$:
 $x = -1, y = f(-1) = (-1+2)(-1-1)(-1-4) = 10$.
 $x = 2, y = f(2) = (2+2)(2-1)(2-4) = -8$.
 Therefore, the average rate of change in y with respect to x over the interval $[-1, 2]$ is given by

$$\frac{f(2) - f(-1)}{2 - (-1)} = \frac{-8 - 10}{3} = -6$$

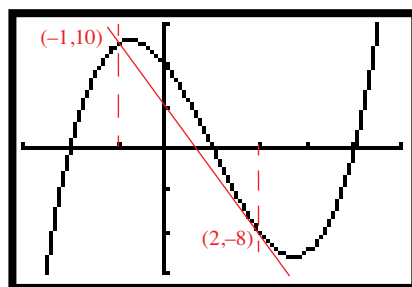

- To determine the rate of change at $x = 4$, we choose a second point close to $x = 4$. In this case, we use the point $x = 4 + h$, where h can be considered to be a very small number. We will look at what happens to the gradient of the secant joining the points $(4, 0)$ and $(4 + h, f(4 + h))$ as h approaches zero.

The gradient of the secant is given by

$$\frac{f(4+h) - f(4)}{(4+h) - 4} = \frac{f(4+h) - f(4)}{h}$$

We now need to determine the value of $f(4+h)$ and $f(4)$. However, we already know that $f(4) = 0$.

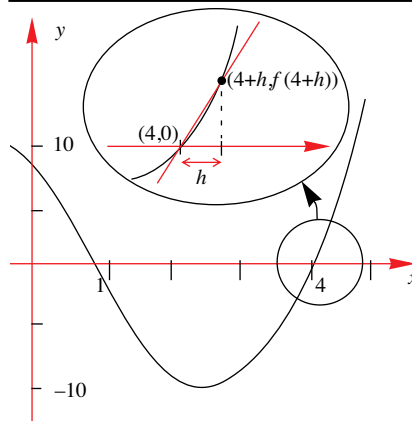

MATHEMATICS – Higher Level (Core)

We can now find values for $f(4 + h)$ as h approaches zero.

For $h = 0.1$, $f(4 + 0.1) = f(4.1) = (4.1 + 2)(4.1 - 1)(4.1 - 4) = 6.1 \times 3.1 \times 0.1 = 1.891$.

Therefore, $\frac{f(4 + h) - f(4)}{h} = \frac{1.891 - 0}{0.1} = 18.91$, for $h = 0.1$.

We can continue in this same manner by making the value of h smaller still.

We do this by setting up a table of values:

h	$\frac{f(4 + h) - f(4)}{h}$
0.01	18.09010000
0.001	18.00900100
0.0001	18.00090001

From the table, it appears that as h approaches zero, the gradient of the secant (which becomes the gradient of the tangent at $(4,0)$) approaches a value of 18.

Therefore, we have that the rate of change of f at $(4,0)$ is 18.

More formally we write this result as $\lim_{h \rightarrow 0} \frac{f(4 + h) - f(4)}{h} = 18$, which is read as

“The limit as h tends to zero of $\frac{f(4 + h) - f(4)}{h}$ is equal to 18.”

Which is saying that if we make h as small as we can, then $\frac{f(4 + h) - f(4)}{h}$ equals 18.

EXAMPLE 18.8

The population of a city at the start of 2000 was 2.3 million, and its projected population, N million, is modelled by the equation $N(t) = 2.3e^{0.0142t}$, where $t \geq 0$ and is measured in years since the beginning of 2000. Find the rate of growth of the population in this city at the start of 2005.

Solution

Finding the rate of growth of the population at the start of 2005 as opposed to finding the rate over a period of time means that we are finding the instantaneous rate of change. To do this, we proceed as in the previous example, i.e., we use a limiting approach.

Consider the two points, $P(5, N(5))$ (start of 2005) and $A(5 + h, N(5 + h))$ on the curve representing the population size:

The gradient of the secant passing through P and A is given by $\frac{N(5 + h) - N(5)}{(5 + h) - 5} = \frac{N(5 + h) - N(5)}{h}$

Now, $N(5) = 2.3e^{0.0142 \times 5} = 2.3e^{0.071}$

and $N(5 + h) = 2.3e^{0.0142(5 + h)}$

Therefore, the gradient of the secant is given by

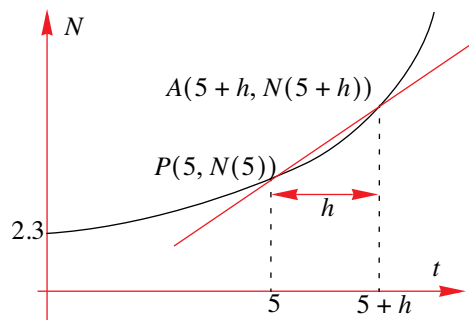

$$\begin{aligned}\frac{2.3e^{0.0142(5+h)} - 2.3e^{0.071}}{h} &= \frac{2.3e^{0.071+0.0142h} - 2.3e^{0.071}}{h} \\ &= \frac{2.3e^{0.071}(e^{0.0142h} - 1)}{h}\end{aligned}$$

Again we set up a table of values:

h	$\frac{2.3e^{0.071}(e^{0.0142h} - 1)}{h}$
0.1	$\frac{2.3e^{0.071}(e^{0.0142 \times 0.1} - 1)}{0.1} = 0.035088$
0.01	$\frac{2.3e^{0.071}(e^{0.0142 \times 0.01} - 1)}{0.01} = 0.035066$
0.001	$\frac{2.3e^{0.071}(e^{0.0142 \times 0.001} - 1)}{0.001} = 0.035063$
0.0001	$\frac{2.3e^{0.071}(e^{0.0142 \times 0.0001} - 1)}{0.0001} = 0.035063$

Using limit notation we have, $\lim_{h \rightarrow 0} \frac{N(5+h) - N(5)}{h} = 0.035063$.

That is, the growth rate at the start of 2005 is 35,063 people per year.

EXERCISES 18.3

1. For each of the graphs shown, find the gradient of the secant joining the points P and Q.

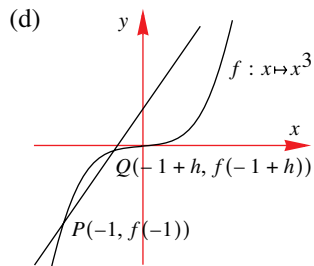
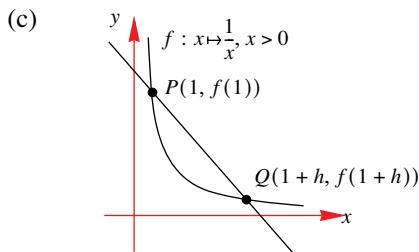
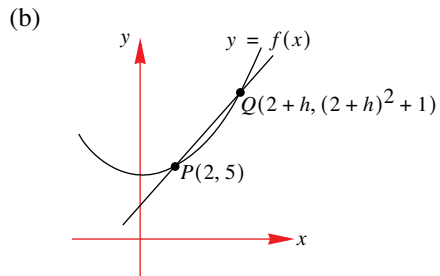
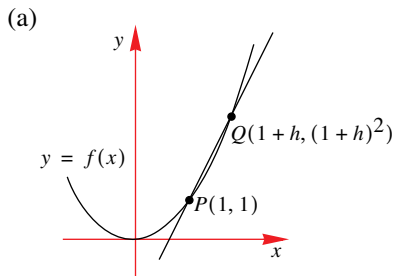

MATHEMATICS – Higher Level (Core)

- 2.** For each of the graphs in Q.1., use a limiting argument to deduce the instantaneous rate of change of the given function at the point P .
- 3.** For each of the functions, f , given below, find the gradient of the secant joining the points $P(a, f(a))$ & $Q(a+h, f(a+h))$.
- (a) $f(x) = 3 + x^2$ (b) $f(x) = 1 - x^2$ (c) $f(x) = (x+1)^2 - 2$
(d) $f(x) = x^3 + x$ (e) $f(x) = 2 - x^3$ (f) $f(x) = x^3 - x^2$
(g) $f(x) = \frac{2}{x}$ (h) $f(x) = \frac{1}{x-1}$ (i) $f(x) = \sqrt{x}$
- 4.** For each of the functions, f , given below, find the gradient of the secant joining the points $P(a, f(a))$ & $Q(a+h, f(a+h))$ and hence deduce the gradient of the tangent drawn at the point P .
- (a) $f(x) = x$ (b) $f(x) = x^2$ (c) $f(x) = x^3$ (d) $f(x) = x^4$.
- Hence deduce the gradient of the tangent drawn at the point $P(a, f(a))$ for the function $f(x) = x^n, n \in N$.
- 5.** An object moves along a straight line. Its position, x metres (from a fixed point O), at time t seconds is given by $x(t) = 2t^2 - 3t + 1, t \geq 0$.
- (a) Sketch the graph of its displacement function.
- (b) Determine
- its average velocity over the interval from $t = 1$ to $t = 2$
 - its average velocity over the interval $t = 1$ to $t = 1.5$
 - its average velocity over the interval $t = 1$ to $t = 1.1$
- (c) Show that its average velocity over the interval $t = 1$ to $t = 1 + h$, where h is small is given by $1 + 2h$.
- (d) How can the last result help us determine the objects' velocity at $t = 1$?
- (e) Show that its average velocity over any time interval of length h is given by $4t + 2h - 3$. Hence deduce the object's velocity at any time t during its motion.
- 6.** The healing process of a certain type of wound is measured by the decrease in surface area that the wound occupies on the skin. A certain skin wound has its surface area modelled by the equation $S(t) = 20 \times 2^{-0.1t}$ where S sq. cm is the unhealed area t days after the skin received the wound.
- (a) Sketch the graph of $S(t) = 20 \times 2^{-0.1t}, t \geq 0$.
- (b)
- What area did the wound originally cover?
 - What area will the wound occupy after 2 days?
 - How much of the wound healed over the two day period?
 - Find the average rate at which the wound heals over the first two days.
- (c) How much of the wound would heal over a period of h days?
- (d) Find the rate at which the wound heals
- immediately after it occurs
 - one day after it occurred.

18.4 DIFFERENTIATION PROCESS

18.4.1 THE DERIVATIVE AND THE GRADIENT FUNCTION

In the previous sections we concentrated our efforts on determining the average rate of change for a function over some fixed interval. Then proceeded to find the instantaneous rate of change at a particular point (on the curve). We now consider the same process, with the exception that we will discuss the instantaneous rate at any point $P(x, f(x))$. The result will be an expression that will enable us to determine the instantaneous rate of change of the function at any point on the curve. Because the instantaneous rate of change at a point on a curve is simply a measure of the gradient of the curve at that point, our newly found result will be known as the **gradient function** (otherwise known as the derivative of the function).

For a continuous function, $y = f(x)$, we deduced that the **instantaneous rate of change at the point** $P(a, f(a))$ is given by $\frac{f(a+h) - f(a)}{h}$, where h is taken to be very small (in fact we say that h approaches or **tends to zero**).

So, to determine the rate at which a graph changes at a single point, we need to find the slope of the tangent line at that point.

This becomes obvious if we look back at our ‘zooming in process’—where the tangent line to the function at the point $P(a, f(a))$ is the line that best approximates the graph at that point.

Rather than considering a fixed point $P(a, f(a))$, we now consider any point $P(x, f(x))$ on the curve with equation $y = f(x)$:

The rate of change of the function f at $P(x, f(x))$ is therefore given by the gradient of the tangent to the curve at P .

If point Q comes as close as possible to the point P , so that h **approaches zero**, then, the gradient of the tangent at P is given by the gradient of the secant joining the points $P(x, f(x))$ and $Q(x+h, f(x+h))$ as $h \rightarrow 0$.

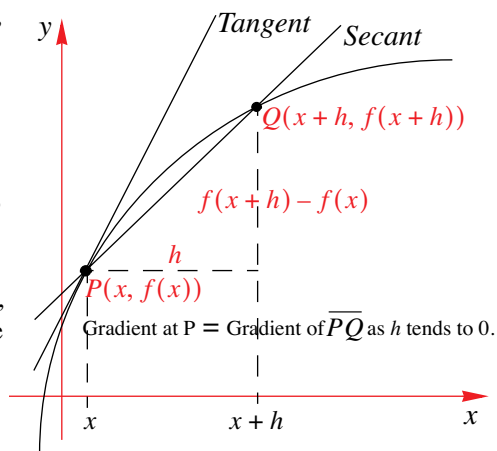
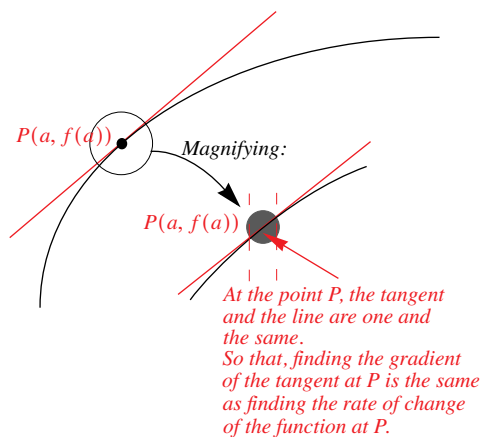

In mathematical notation we have:

$$\text{Rate of change at P} = \lim_{h \rightarrow 0} \frac{f(x+h) - f(x)}{h}$$

18.4.2 NOTATION AND LANGUAGE

We now introduce the term **derivative of a function**:

The **rate of change** of $f(x)$ at $P(x, f(x)) =$ **Gradient function** of $f(x)$ at $P(x, f(x))$
 $=$ **The derivative** of $f(x)$

$$= \lim_{h \rightarrow 0} \frac{f(x+h) - f(x)}{h}$$

The derivative of a function $f(x)$ is denoted by $f'(x)$ and is read as “ f dash of x ”.

That is,

$$f'(x) = \lim_{h \rightarrow 0} \frac{f(x+h) - f(x)}{h}$$

Finding the derivative of a function using this approach is referred to as *finding the derivative of f from first principles*.

It is important to realise that in finding $f'(x)$ we have a new function—called the **gradient function**, because the expression $f'(x)$ will give the gradient anywhere on the curve of $f(x)$. So that if we want the gradient of the function $f(x)$ at $x = 5$, we first determine $f'(x)$ and then substitute the value of $x = 5$ into the equation of $f'(x)$.

EXAMPLE 18.9

Using the first principles method, find the derivative (*or the gradient function*) of the function $f(x) = 3x^2 + 4$. Hence, find the gradient of the function at $x = 3$.

S
o
l
u
t
i
o
n

Using the first principles method means that we must make use of the expression

$$f'(x) = \lim_{h \rightarrow 0} \frac{f(x+h) - f(x)}{h} \quad (1)$$

We start by first evaluating the expression $f(x+h) - f(x)$:

That is:

$$\begin{aligned} f(x+h) - f(x) &= 3(x+h)^2 + 4 - [3x^2 + 4] = 3(x^2 + 2xh + h^2) + 4 - 3x^2 - 4 \\ &= 3x^2 + 6xh + 3h^2 - 3x^2 \\ &= 6xh + 3h^2 \end{aligned}$$

Substituting this result into (1):

$$\begin{aligned} \lim_{h \rightarrow 0} \frac{f(x+h) - f(x)}{h} &= \lim_{h \rightarrow 0} \frac{6xh + 3h^2}{h} \\ &= \lim_{h \rightarrow 0} \frac{h(6x + 3h)}{h} \\ &= \lim_{h \rightarrow 0} (6x + 3h), h \neq 0 \\ &= 6x \end{aligned}$$

That is, we now have the gradient function $f'(x) = 6x$.

To determine the gradient of the function at $x = 3$, we need to substitute the value $x = 3$ into the gradient function. That is, $f'(3) = 6 \times 3 = 18$.

Using the TI-83 we can determine the derivative at $x = 3$ by using the 'nDeriv(' command from the MATH menu:

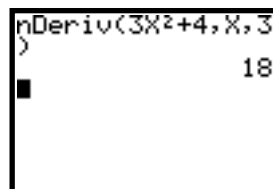
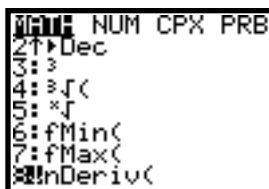

EXAMPLE 18.10

A particle moving along a straight line has its position at time t seconds governed by the equation $p(t) = t - 0.2t^2$, $t \geq 0$, where $p(t)$ is its position in metres from a fixed point O.

- (a) Find the particle's velocity after it has been in motion for 1 second.
 (b) Find the particle's velocity at time $t = a$, $a > 0$.

**S
o
l
u
t
i
o
n**

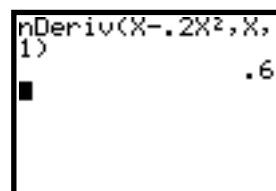
- (a) This part is readily done by making use of the TI-83:
 So, we have that the particle's velocity is 0.6 m/s



- (b) Let us again make use of the TI-83:

We enter the function $p(t) = t - 0.2t^2$, $t \geq 0$ as Y_1 and

then enter Y_2 as $\mathbf{nDeriv}(Y_1, X, X)$. Once this is done we sketch both Y_1 and Y_2 .

The graph of Y_2 represents the gradient function of Y_1 , i.e., the derivative of Y_1 .

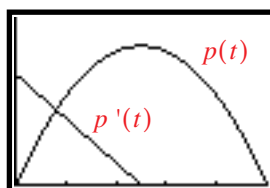
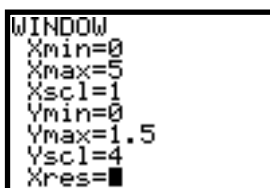
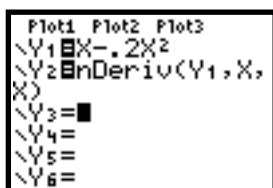

The graph of $p'(t)$ appears to be a straight line passing through the points $(0,1)$ and $(2.5, 0)$ and so we can obtain the equation of this straight line:

gradient = $m = \frac{0 - 1}{2.5 - 0} = -0.4$. Then, using $y - 1 = (-0.4)(x - 0)$ we have, $y = -0.4x + 1$.

Changing to the appropriate variables we have, $v(t) = -0.4t + 1$.

Therefore at $t = a$, $v(a) = -0.4a + 1$.

Obviously, this method relied on our ability to spot the type of function $\mathbf{nDeriv}(Y_1, X, X)$ produced. The fact that it could then be readily determined made it all fairly straight forward. However, more often than not, this will not be the case. So we make use of the definition of differentiation to obtain the velocity as the derivative of the position function.

$$v(t) = p'(t) = \lim_{h \rightarrow 0} \frac{p(t+h) - p(t)}{h}$$

We start by determining $p(t+h) - p(t) = (t+h) - 0.2(t+h)^2 - [t - 0.2t^2]$
 $= t + h - 0.2(t^2 + 2th + h^2) - t + 0.2t^2$
 $= -0.4th + h - 0.2h^2$

$$\text{Therefore, } v(t) = \lim_{h \rightarrow 0} \frac{-0.4th + h - 0.2h^2}{h} = \lim_{h \rightarrow 0} (-0.4t + 1 - 0.2h) = -0.4t + 1$$

And so, $v(a) = -0.4a + 1$.

EXERCISES 18.4

1. Use a limiting process to find the gradients of these curves at the points indicated:

(a) $x \mapsto x^3$ at $x = 1$	(b) $v = 2t^2 - 1$ at $t = 2$
(c) $f(x) = \frac{1}{x}$ at $x = 3$	(d) $x \mapsto 2^x$ at $x = 1$
(e) $f = t^2 - 2t + 3$ at $t = 0.5$	(f) $t \mapsto \frac{t^2 - 1}{t}$ at $t = 4$

2. An object is dropped from a high building. The distance, d metres, that the object has fallen, t seconds after it is released, is given by the formula $d = 4.9t^2$, $0 \leq t \leq 3$.
 - (a) Find the distance fallen during the first second.
 - (b) Find the distance fallen between $t = 1$ and $t = h + 1$ seconds.
 - (c) Hence, find the speed of the object 1 second after it is released.

3. Find, from first principles, the gradient function, f' , of the following

(a) $f: x \mapsto 4x^2$	(b) $f: x \mapsto 5x^2$	(c) $f: x \mapsto 4x^3$
(d) $f: x \mapsto 5x^3$	(e) $f: x \mapsto 4x^4$	(f) $f: x \mapsto 5x^4$

Can you see a pattern in your results?

4. Find, from first principles, the derivative of the following functions

(a) $f(x) = 2x^2 - 5$	(b) $g(x) = 2 - x$	(c) $g(x) = 2 - x + x^3$
(d) $f(x) = \frac{1}{x}$	(e) $f(x) = \frac{2}{x + 1}$	(f) $f(x) = \sqrt{x}$

5. A particle moving along a straight line has its position at time t seconds governed by the equation $x(t) = 2t - 0.5t^2$, $t \geq 0$, where $x(t)$ is its position in metres from the origin O.
 - (a) Find the particle's velocity after it has been in motion for 1 second.
 - (b) Find the particle's velocity at time $t = a$, $a > 0$.

6. A particle moving along a straight line has its position at time t seconds governed by the equation $x(t) = 4t^2 - t^3$, $t \geq 0$, where $x(t)$ is its position in metres from the origin O.
 - (a) Sketch the displacement-time graph of the motion over the first five seconds
 - (b) Find the particle's velocity at time
 - i. $t = 1$
 - ii. $t = 2$
 - (c) Find the particle's velocity at any time t , $t \geq 0$.
 - (d) When will the particle first come to rest?

19.1 DIFFERENTIATION

19.1.1 REVIEW

1. Rate of change, gradient and the derivative

The **rate of change** of a curve at a point gives a **measure of the gradient** of the curve at that point. When finding the **derivative** of the equation of a curve we obtain the **gradient function**. As the name suggests, the gradient function enables us to find the gradient at any point on the curve.

2. Differentiation

Differentiation is the process of finding the derivative of a function. The derivative of a function is often called its **derived function**.

3. Language and notation

The **derivative of $f(x)$ with respect to x** is usually written as $f'(x)$ (read as “*f* dash of *x*”) or $\frac{d}{dx}(f(x))$ (read as “*dee-dee-x* of *f(x)*”).

The **derivative of y with respect to x** is usually written as $\frac{dy}{dx}$ (read as “*dee-y-dee-x*”) or y' (read as “*y*-dash of *x*”).

4. Average rate \rightarrow instantaneous rate

The **average rate** of change of the function $f(x)$ over the interval $x = x_1$ to $x = x_2$ is graphically represented by the **gradient of the secant** passing through the two points $(x_1, f(x_1))$ and $(x_2, f(x_2))$ on the curve $y = f(x)$.

Notice that when we talk about the average rate, we require two points on a curve.
i.e., “*.. over the interval ..*” or “*.. from .. to ..*”

Whereas the **instantaneous rate** of change of $f(x)$ at the point $x = x_1$ is graphically represented by the **gradient of the tangent** at the point $(x_1, f(x_1))$ on the curve $y = f(x)$.

Notice that when we talk about the instantaneous rate, we refer to only one point,
i.e., “*.. at the point ..*”

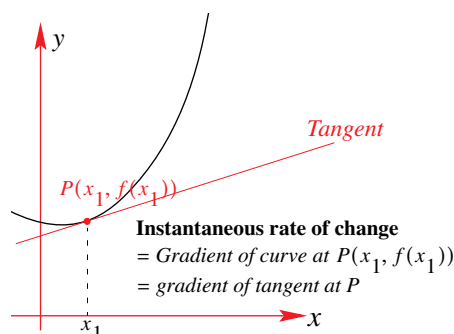
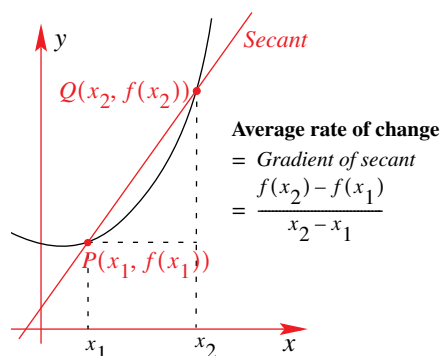

5. Different notation

The basic difference between the two can be seen in the diagram below:

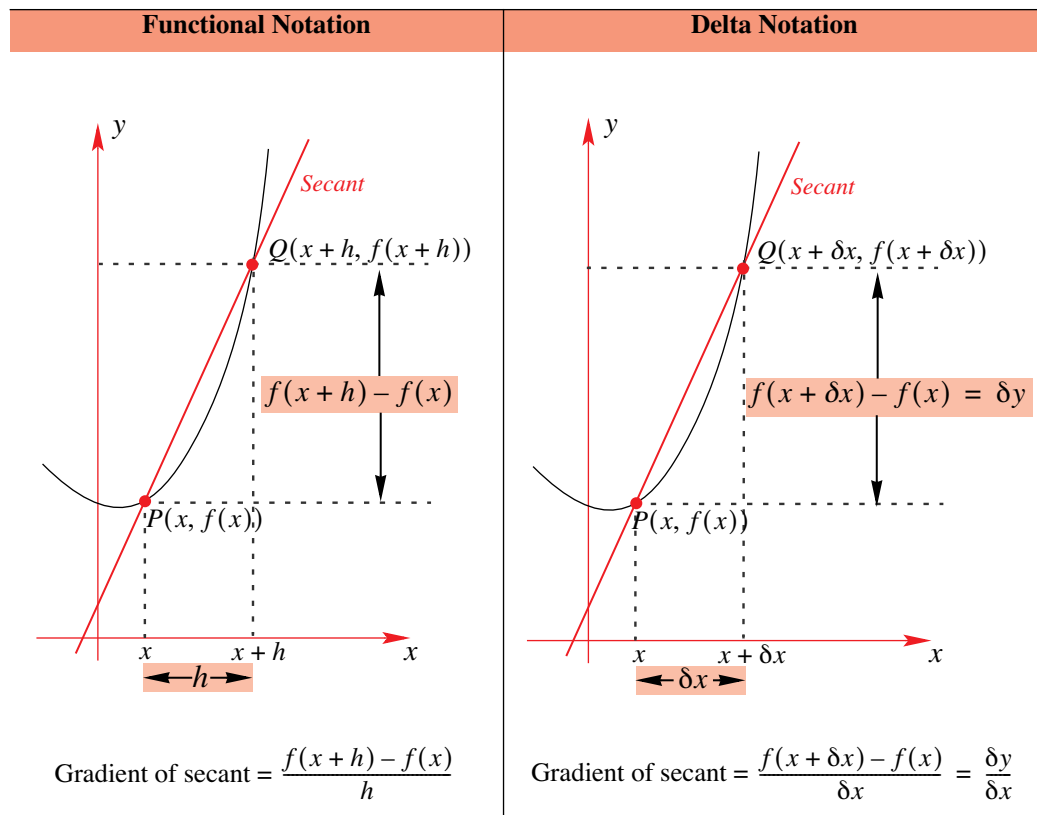

To find the gradient at some point P , that is, to find the derivative of the function at any point P on the curve defined by the equation $y = f(x)$, we use the method of first principles:

$$f'(x) = \lim_{h \rightarrow 0} \frac{f(x+h) - f(x)}{h}, h \neq 0$$

$$\frac{dy}{dx} = \lim_{\delta x \rightarrow 0} \frac{\delta y}{\delta x}, \delta x \neq 0$$

Using the delta notation, we read $\frac{dy}{dx} = \lim_{\delta x \rightarrow 0} \frac{\delta y}{\delta x}$, $\delta x \neq 0$ as “dee-y-dee-x is equal to the limit as delta x (δx) tends to zero of delta y (δy) on delta x (δx)”. This is in part where the expression “The derivative of y with respect to x ” stems from. The notation $f'(x)$ is due to one of the greatest eighteenth century mathematicians, Joseph Louis Lagrange (1736–1813), whereas the notation $\frac{dy}{dx}$ is attributed to that other great mathematician, Gottfried Wilhelm Leibniz (1646–1716).

As we now have the definition of the derivative, given by the expression $\frac{dy}{dx} = \lim_{\delta x \rightarrow 0} \frac{\delta y}{\delta x}$, $\delta x \neq 0$

or $f'(x) = \lim_{h \rightarrow 0} \frac{f(x+h) - f(x)}{h}$, $h \neq 0$, then to differentiate a function $y = f(x)$ one of these expressions is used. Notice that the expression $f'(x)$ is itself a function and for this reason we also refer to the derivative as the **gradient function** of $y = f(x)$.

EXAMPLE 19.1

 Find the derivative (the gradient function) of $f(x) = x^3 + 1$.

Solution

By definition, we have that $f'(x) = \lim_{h \rightarrow 0} \frac{f(x+h) - f(x)}{h}$, $h \neq 0$, and so, we start by simplifying the expression $f(x+h) - f(x)$:

$$\begin{aligned} f(x+h) - f(x) &= (x+h)^3 + 1 - (x^3 + 1) \\ &= x^3 + 3x^2h + 3xh^2 + h^3 + 1 - x^3 - 1 \\ &= 3x^2h + 3xh^2 + h^3 \\ &= h(3x^2 + 3xh + h^2) \end{aligned}$$

$$\begin{aligned} \text{Therefore we have } f'(x) &= \lim_{h \rightarrow 0} \frac{f(x+h) - f(x)}{h}, h \neq 0 = \lim_{h \rightarrow 0} \frac{h(3x^2 + 3xh + h^2)}{h}, h \neq 0 \\ &= \lim_{h \rightarrow 0} (3x^2 + 3xh + h^2), h \neq 0 \\ &= 3x^2 \end{aligned}$$

That is, $f(x) = x^3 + 1 \Rightarrow f'(x) = 3x^2$.

EXAMPLE 19.2

 Differentiate the function $f(x) = \sqrt{x}$.

Solution

As in the previous example, we first simplify the expression $f(x+h) - f(x)$:

$$f(x+h) - f(x) = \sqrt{x+h} - \sqrt{x}.$$

However, in this case it appears that we can go no further. However:

$$f'(x) = \lim_{h \rightarrow 0} \frac{\sqrt{x+h} - \sqrt{x}}{h} = \lim_{h \rightarrow 0} \frac{\sqrt{x+h} - \sqrt{x}}{h} \times \frac{\sqrt{x+h} + \sqrt{x}}{\sqrt{x+h} + \sqrt{x}}$$

The difficulty is in realising that we need to multiply by $\frac{\sqrt{x+h} + \sqrt{x}}{\sqrt{x+h} + \sqrt{x}}$ (very tricky!). We do this

so that we can rationalise the numerator. This will, hopefully, lead to an expression which will be more manageable. Carrying out the multiplication we have:

$$\begin{aligned} f'(x) &= \lim_{h \rightarrow 0} \frac{(\sqrt{x+h} - \sqrt{x})(\sqrt{x+h} + \sqrt{x})}{h(\sqrt{x+h} + \sqrt{x})}, h \neq 0 = \lim_{h \rightarrow 0} \frac{((x+h) - x)}{h(\sqrt{x+h} + \sqrt{x})}, h \neq 0 \\ &= \lim_{h \rightarrow 0} \frac{h}{h(\sqrt{x+h} + \sqrt{x})}, h \neq 0 \\ &= \lim_{h \rightarrow 0} \frac{1}{\sqrt{x+h} + \sqrt{x}}, h \neq 0 \\ &= \frac{1}{\sqrt{x} + \sqrt{x}} \\ &= \frac{1}{2\sqrt{x}} \end{aligned}$$

Notice that the function $f(x) = \sqrt{x}$, $x \geq 0$ has a domain defined by $x \geq 0$. Whereas its gradient

function, $f'(x) = \frac{1}{2\sqrt{x}}$, $x > 0$ has a domain defined by $x > 0$.

So, in this instance, the domain of the function and that of its derivative (or gradient function) are not the same. We will investigate these matters in more depth later on.

19.1.2 POWER RULE FOR DIFFERENTIATION

Finding the derivative from first principles can be tedious. The previous two examples clearly show this. However, using the first principles approach, produces the results shown in the table below:

Function $y = f(x)$	x^4	x^3	x^2	x^1	x^{-1}	x^{-2}
Derivative $\frac{dy}{dx} = f'(x)$	$4x^3$	$3x^2$	$2x^1$	$1x^0$	$-1x^{-2}$	$-2x^{-3}$

Based on these results and following the general pattern, it is reasonable to assume the general result that if

$$y = x^n, n \in \mathbb{Z}, \text{ then } \frac{dy}{dx} = nx^{n-1}.$$

In fact this rule is true for any exponent $n \in \mathbb{R}$, i.e., for any real number n .

For example, if we look at the square root function, then we have that $y = \sqrt{x} = x^{1/2}$. So in this case we have that $n = \frac{1}{2}$. Then, using our rule we have $y = \sqrt{x} = x^{\frac{1}{2}} \Rightarrow \frac{dy}{dx} = \frac{1}{2}x^{\frac{1}{2}-1} = \frac{1}{2}x^{-\frac{1}{2}} = \frac{1}{2\sqrt{x}}$.

Which is the result we obtained in Example 19.2 when we used the first principle method. This result is known as the **power rule for differentiation**.

Notice that for the case $n = 0$, then $y = x^0$ and so we have that $\frac{dy}{dx} = 0x^{0-1} = 0$.

Note: The function $y = x^0$ represents the horizontal straight line $y = 1$, and so its gradient will always be 0. In fact, for the case where $y = k$ (a real constant) $y = kx^0 \Rightarrow \frac{dy}{dx} = k \times 0x^{0-1} = 0$.

As the function $y = k$ represents a horizontal straight line its gradient will always be 0. We therefore have the power rule:

The function $f: x \mapsto x^n$, has a gradient function (or derivative) given by $f': x \mapsto nx^{n-1}$. This can also be written as:

$$\text{If } y = x^n \text{ then } \frac{dy}{dx} = nx^{n-1} \quad \text{or If } f(x) = x^n \text{ then } f'(x) = nx^{n-1}$$

We prove the above for the case where n is a positive integer and leave further proofs till §19.8.

Let $f(x) = x^n$ where n is a positive integer. Using the definition of the derivative we have

$$f'(x) = \lim_{h \rightarrow 0} \frac{f(x+h) - f(x)}{h} = \lim_{h \rightarrow 0} \frac{(x+h)^n - x^n}{h}$$

Simplifying the numerator, we have:

$$\begin{aligned} (x+h)^n - x^n &= \left[x^n + \binom{n}{1}x^{n-1}h + \binom{n}{2}x^{n-2}h^2 + \dots + \binom{n}{n-1}xh^{n-1} + h^n \right] - x^n \\ &= \binom{n}{1}x^{n-1}h + \binom{n}{2}x^{n-2}h^2 + \dots + \binom{n}{n-1}xh^{n-1} + h^n \\ &= nx^{n-1}h + \frac{n(n-1)}{2}x^{n-2}h^2 + \dots + nxh^{n-1} + h^n \end{aligned}$$

We now have that

$$\begin{aligned} f'(x) &= \lim_{h \rightarrow 0} \frac{nx^{n-1}h + \frac{n(n-1)}{2}x^{n-2}h^2 + \dots + nxh^{n-1} + h^n}{h} \\ &= \lim_{h \rightarrow 0} \left(nx^{n-1} + \frac{n(n-1)}{2}x^{n-2}h + \dots + nxh^{n-2} + h^{n-1} \right) \\ &= nx^{n-1} \end{aligned}$$

EXAMPLE 19.3

Use the power rule to differentiate the following functions

(a) x^6 (b) $\frac{1}{\sqrt{x}}$ (c) $\sqrt[3]{x}$ (d) $\frac{1}{x^2}$

S
o
l
u
t
i
o
n

Before we differentiate these functions, each function must be rewritten in the form x^n before we can use the power rule.

(a) Let $f(x) = x^6 \Rightarrow f'(x) = 6x^{6-1} = 6x^5$

(b) Let $y = \frac{1}{\sqrt{x}}$. Remember, we first need to rewrite it in the form x^n :

Function	Step 1 Rewrite:	Step 2 Use power rule:	Step 3 Simplify:
$y = \frac{1}{\sqrt{x}}$	$y = x^{-1/2}$	$\frac{dy}{dx} = -\frac{1}{2}x^{-\frac{1}{2}-1}$	$\frac{dy}{dx} = -\frac{1}{2}x^{-\frac{3}{2}} = -\frac{1}{2\sqrt{x^3}}$

(c) Let $y = \sqrt[3]{x}$. As in the previous example, we rewrite this function in the form x^n so that we can use the power rule:

Function	Step 1 Rewrite:	Step 2 Use power rule:	Step 3 Simplify:
$y = \sqrt[3]{x}$	$y = x^{\frac{1}{3}}$	$\frac{dy}{dx} = \frac{1}{3}x^{\frac{1}{3}-1}$	$\frac{dy}{dx} = \frac{1}{3}x^{-\frac{2}{3}} = \frac{1}{3\sqrt[3]{x^2}}$

(d) Let $f(x) = \frac{1}{x^2}$ so that $f(x) = x^{-2} \therefore f'(x) = -2x^{-2-1} = -2x^{-3}$. That is, $f'(x) = -\frac{2}{x^3}$.

MATHEMATICS – Higher Level (Core)

An extension of the power rule is the derivative of $f: x \mapsto ax^n$, where a is a real constant. In this case we have the general result:

$$\text{If } f: x \mapsto ax^n \text{ then } f': x \mapsto anx^{n-1}$$

EXAMPLE 19.4

Differentiate the following functions:

(a) $12x^3$ (b) $-\frac{4}{x}$ (c) $\frac{x^2}{7}$

S
o
l
i
t
i
o
n

(a) Let $y = 12x^3 \Rightarrow \frac{dy}{dx} = 12 \times 3x^{3-1} = 36x^2$.

(b) Let $f(x) = -\frac{4}{x}$, that is, $f(x) = -4x^{-1} \Rightarrow f'(x) = -4 \times -1x^{-1-1} = 4x^{-2} = \frac{4}{x^2}$.

(c) Let $f(x) = \frac{x^2}{7}$, that is, $f(x) = \frac{1}{7}x^2 \Rightarrow f'(x) = \frac{1}{7} \times 2x^{2-1} = \frac{2}{7}x$.

19.1.3 DERIVATIVE OF A SUM OR DIFFERENCE

This rule states that the derivative of a sum (or a difference) is equal to the sum (or the difference) of the derivatives. That is,

$$\text{If } y = f(x) \pm g(x) \text{ then } \frac{dy}{dx} = f'(x) \pm g'(x)$$

EXAMPLE 19.5

Differentiate the following functions

(a) $2x^3 + 5x - 9$ (b) $\sqrt{x} - \frac{5}{x^3} + x$ (c) $x^{1/3} + x^{5/4} - \sqrt{2x}$

S
o
l
i
t
i
o
n

(a) Let $y = 2x^3 + 5x - 9 \Rightarrow \frac{dy}{dx} = \frac{d}{dx}(2x^3 + 5x - 9) = \frac{d}{dx}(2x^3) + \frac{d}{dx}(5x) - \frac{d}{dx}(9)$
 $= 6x^2 + 5$

Notice we have used a slightly different notation, namely that $f'(x) = \frac{d}{dx}(f(x))$. We can

think of $\frac{d}{dx}$ as the differentiation operator, so that $\frac{d}{dx}(f(x))$ or $\frac{d}{dx}(y)$ is an operation of differentiation done on $f(x)$ or y respectively.

(b) Let $f(x) = \sqrt{x} - \frac{5}{x^3} + x \Rightarrow f'(x) = \frac{d}{dx}\left(\sqrt{x} - \frac{5}{x^3} + x\right) = \frac{d}{dx}(x^{1/2} - 5x^{-3} + x)$
 $= \frac{1}{2}x^{-1/2} - 5 \times -3x^{-3-1} + 1$
 $= \frac{1}{2\sqrt{x}} + \frac{15}{x^4} + 1$

$$\begin{aligned}
 \text{(c)} \quad \frac{d}{dx}(x^{1/3} + x^{5/4} - \sqrt{2x}) &= \frac{d}{dx}(x^{1/3}) + \frac{d}{dx}(x^{5/4}) - \frac{d}{dx}(\sqrt{2x}) \\
 &= \frac{1}{3}x^{-2/3} + \frac{5}{4}x^{1/4} - \sqrt{2} \times \frac{1}{2}x^{-1/2}
 \end{aligned}$$

Note, to find $\frac{d}{dx}(\sqrt{2x})$ we first express it as $\frac{d}{dx}(\sqrt{2} \times \sqrt{x}) = \sqrt{2} \times \frac{d}{dx}(\sqrt{x}) = \sqrt{2} \times \frac{d}{dx}(x^{1/2})$.

EXAMPLE 19.6
Miscellaneous Examples

Differentiate the following

$$\begin{array}{lll}
 \text{(a)} \quad 5\sqrt{x} - 9, x \geq 0 & \text{(b)} \quad (x^3 + 2)^2 & \text{(c)} \quad \left(\sqrt{x} - \frac{2}{\sqrt{x}}\right)^2 \\
 \text{(d)} \quad \frac{5x^2 + 4x - 3}{x} & \text{(e)} \quad \sqrt{x}(7x^2 - 3x + 2) & \text{(f)} \quad \frac{2x^4 - 4x + 3}{\sqrt{x}}
 \end{array}$$

**S
o
l
u
t
i
o
n**

$$\text{(a)} \quad \frac{d}{dx}(5\sqrt{x} - 9) = \frac{d}{dx}(5x^{1/2} - 9) = 5 \times \frac{1}{2}x^{\frac{1}{2}-1} - 0 = \frac{5}{2}x^{-1/2} = \frac{5}{2\sqrt{x}}.$$

(b) The first step is to expand the bracket so that each term is in the form of ax^n .

$$\frac{d}{dx}((x^3 + 2)^2) = \frac{d}{dx}(x^6 + 4x^3 + 4) = 6x^5 + 12x^2$$

(c) Again we expand first, and then differentiate:

$$\begin{aligned}
 \frac{d}{dx}\left(\left(\sqrt{x} - \frac{2}{\sqrt{x}}\right)^2\right) &= \frac{d}{dx}\left((\sqrt{x})^2 - 2\sqrt{x} \times \frac{2}{\sqrt{x}} + \left(\frac{2}{\sqrt{x}}\right)^2\right) = \frac{d}{dx}\left(x - 4 + \frac{4}{x}\right) \\
 &= \frac{d}{dx}(x - 4 + 4x^{-1}) \\
 &= 1 - \frac{4}{x^2}
 \end{aligned}$$

$$\text{(d)} \quad \frac{d}{dx}\left(\frac{5x^2 + 4x - 3}{x}\right) = \frac{d}{dx}\left(\frac{5x^2}{x} + \frac{4x}{x} - \frac{3}{x}\right) = \frac{d}{dx}(5x + 4 - 3x^{-1}) = 5 + \frac{3}{x^2}$$

$$\begin{aligned}
 \text{(e)} \quad \frac{d}{dx}(\sqrt{x}(7x^2 - 3x + 2)) &= \frac{d}{dx}(x^{1/2}(7x^2 - 3x + 2)) = \frac{d}{dx}(7x^{5/2} - 3x^{3/2} + 2x^{1/2}) \\
 &= \frac{35}{2}x^{3/2} - \frac{9}{2}x^{1/2} + x^{-1/2} \\
 &= \frac{35}{2}\sqrt{x^3} - \frac{9}{2}\sqrt{x} + \frac{1}{\sqrt{x}}
 \end{aligned}$$

$$\begin{aligned}
 \text{(f)} \quad \frac{d}{dx}\left(\frac{2x^4 - 4x + 3}{\sqrt{x}}\right) &= \frac{d}{dx}\left(\frac{2x^4}{\sqrt{x}} - \frac{4x}{\sqrt{x}} + \frac{3}{\sqrt{x}}\right) = \frac{d}{dx}\left(2x^{4-\frac{1}{2}} - 4x^{1-\frac{1}{2}} + 3x^{0-\frac{1}{2}}\right) \\
 &= \frac{d}{dx}(2x^{7/2} - 4x^{1/2} + 3x^{-1/2}) \\
 &= 7x^{5/2} - 2x^{-1/2} - \frac{3}{2}x^{-3/2}
 \end{aligned}$$

$$= 7x^2\sqrt{x} - \frac{2}{\sqrt{x}} - \frac{3}{2x\sqrt{x}}$$

EXERCISES 19.1

1. Find the derivative of each of the following

- | | | |
|---------------------------------|-----------------------|------------------------------------|
| (a) x^5 | (b) x^9 | (c) x^{25} |
| (d) $9x^3$ | (e) $-4x^7$ | (f) $\frac{1}{4}x^8$ |
| (g) $x^2 + 8$ | (h) $5x^4 + 2x - 1$ | (i) $-3x^5 + 6x^3 - x$ |
| (j) $20 - \frac{1}{3}x^4 + 10x$ | (k) $3x^3 - 6x^2 + 8$ | (l) $3x - 1 + \frac{x^2}{5} + x^4$ |

2. Find the derivative of each of the following

- | | | |
|--|--|---|
| (a) $\frac{1}{x^3}$ | (b) $\sqrt{x^3}$ | (c) $\sqrt{x^5}$ |
| (d) $\sqrt[3]{x}$ | (e) $4\sqrt{x}$ | (f) $6\sqrt{x^3}$ |
| (g) $2\sqrt{x} - \frac{3}{x} + 12$ | (h) $x\sqrt{x} + \frac{1}{\sqrt{x}} + 2$ | (i) $5\sqrt[3]{x^2} - 9x$ |
| (j) $5x - \frac{x}{\sqrt{x}} + \frac{4}{5x^2}$ | (k) $8\sqrt{x} + 3x^{-5} + \frac{x}{2}$ | (l) $\frac{x}{\sqrt{x^3}} - \frac{2}{x}\sqrt{x^3} + \frac{1}{3}x^3$ |

3. Find the derivative of each of the following

- | | | |
|--|--|---|
| (a) $\sqrt{x}(x+2)$ | (b) $(x+1)(x^3-1)$ | (c) $x\left(x^2+1-\frac{1}{x}\right), x \neq 0$ |
| (d) $\frac{2x-1}{x}, x \neq 0$ | (e) $\frac{\sqrt{x}-2}{\sqrt{x}}, x > 0$ | (f) $\frac{x^2-x+\sqrt{x}}{2x}, x \neq 0$ |
| (g) $\frac{3x^2-7x^3}{x^2}, x \neq 0$ | (h) $\left(x-\frac{2}{x}\right)^2, x \neq 0$ | (i) $\left(x+\frac{1}{x^2}\right)^2, x \neq 0$ |
| (j) $\sqrt{3x} - \frac{1}{3\sqrt{x}}, x > 0$ | (k) $(x-\sqrt[5]{x})^2, x \geq 0$ | (l) $\left(\frac{1}{\sqrt{x}} - \sqrt{x}\right)^3, x > 0$ |

- 4.**
- (a) Show that if $f(x) = x^2 - x$, then $f'(x) = 1 + \frac{2f(x)}{x}$.
- (b) Show that if $f(x) = \sqrt{2x} - 2\sqrt{x}, x \geq 0$, then $\sqrt{2x}f'(x) = 1 - \sqrt{2}, x > 0$.
- (c) Show that if $y = ax^n$ where a is real and $n \in \mathbb{N}$, then $\frac{dy}{dx} = \frac{ny}{x}, x \neq 0$.
- (d) Show that if $y = \frac{1}{\sqrt{x}}, x > 0$, then $\frac{dy}{dx} + \frac{y}{2x} = 0$.

19.2

GRAPHICAL INTERPRETATION OF THE DERIVATIVE

19.2.1 THE VALUE OF THE DERIVATIVE AT A PARTICULAR POINT ON A CURVE

So far in this chapter we have looked at the **gradient function** of $f(x)$, namely $f'(x)$. The function $f'(x)$ represents the gradient at any point on the curve of the original function $f(x)$. In order to determine the gradient at a particular point $x = a$ (say), we revisit the definition of the derivative, $f'(x) = \lim_{h \rightarrow 0} \frac{f(x+h) - f(x)}{h}$. Rather than finding the derivative at ‘any’ point ‘ x ’, we determine the derivative at a particular point ‘ $x = a$ ’. Note we are assuming that the derivative exists at the point ‘ $x = a$ ’.

If the function $f(x)$ can be differentiated (i.e., is differentiable) at $x = a$, then

$$f'(a) = \lim_{h \rightarrow 0} \frac{f(a+h) - f(a)}{h}$$

Since $f'(a)$ gives the gradient of the tangent at $x = a$, it also gives the gradient of the graph of $y = f(x)$ and so the derivative may be used to determine gradients or to find where on a curve a particular gradient exists.

Another form of the derivative at $x = a$ is given by $f'(a) = \lim_{x \rightarrow a} \frac{f(x) - f(a)}{x - a}$. This result follows directly from our previous definition by replacing h with $x - a$. This can be seen by using the following ‘replacements’:

1. If $h = x - a$ then $h \rightarrow 0 \Rightarrow x - a \rightarrow 0 \Rightarrow x \rightarrow a$
and so we replace $\lim_{h \rightarrow 0}$ with $\lim_{x \rightarrow a}$.
2. If $h = x - a$ then $h + a = x$.

We first look at an example that uses a ‘first principle’ approach to determining the gradient of a curve at a particular point.

EXAMPLE 19.7

Let P and Q be points on the curve $y = x^2 - 2x$ for which $x = 2$ and $x = 2 + h$ respectively. Express the gradient of PQ in terms of h and hence find the gradient of the curve $y = x^2 - 2x$ at $x = 2$.

S
o
i
l
u
t
i
o
n

We begin by sketching the relevant curve and placing all the information on our diagram.

At P , $x = 2$ and so $y = 2^2 - 2(2) = 0$.

At Q , $x = 2 + h$ and so, $y = (2 + h)^2 - 2(2 + h) = h^2 + 2h$

Next, we find the gradient of PQ , $m_{PQ} = \frac{\text{rise}}{\text{run}} = \frac{y_2 - y_1}{x_2 - x_1}$.

$$\text{So, } m_{PQ} = \frac{(h^2 + 2h) - 0}{(2 + h) - 2} = \frac{h^2 + 2h}{h} = \frac{h(h + 2)}{h}$$

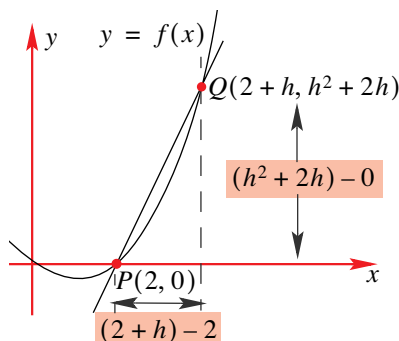

MATHEMATICS – Higher Level (Core)

After cancelling the 'h' we have: $m_{PQ} = h + 2, h \neq 0$

Note the additional condition, $h \neq 0$. Why is this?

We are now in a position to determine the gradient of the curve at $x = 2$.

Gradient at $P = \lim_{h \rightarrow 0} m_{PQ} = \lim_{h \rightarrow 0} (h + 2) = 2$.

EXAMPLE 19.8

Find the gradient of the curve $y = \frac{1}{x-1}$ at the point $(2, 1)$.

S
o
l
u
t
i
o
n

As in the previous example, we choose two points P and Q where $x = 2$ and $x = 2 + h$ respectively.

When $x = 2, y = \frac{1}{2-1} = 1$ and when $x = 2 + h, y = \frac{1}{2+h-1} = \frac{1}{h+1}$.

Meaning that P has coordinates $(2, 1)$ and

Q has coordinates $(2 + h, \frac{1}{1+h})$.

$$m_{PQ} = \frac{\frac{1}{1+h} - 1}{(2+h) - 2} = \frac{\frac{1 - (1+h)}{1+h}}{h} = \frac{-\frac{h}{1+h}}{h} = -\frac{1}{1+h}$$

Then, as $h \rightarrow 0, m_{PQ} \rightarrow -\frac{1}{1}$.

That is, gradient at $(2, 1)$ is given by $\lim_{h \rightarrow 0} -\frac{1}{1+h} = -1$.

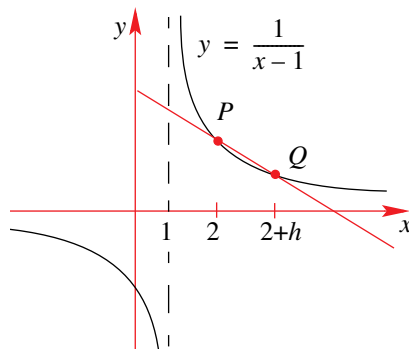

As can be seen from the last two examples, finding the gradient of a curve at a particular point using a 'first principles approach' is rather lengthy. In fact, the process for finding the value of the derivative or the gradient at a particular point on a curve is rather straight forward. This process requires the use of two steps:

Step 1: Find the gradient function (i.e., the derivative). e.g., if $y = f(x)$ find $\frac{dy}{dx} = f'(x)$

Step 2: Substitute the x -value of the point in question into the equation of the derivative. i.e., if we want the gradient at $x = a$, determine $f'(a)$.

EXAMPLE 19.9

Find $f'(3)$ given that $f(x) = x^3 - 2x^2 + 10$.

S
o
l
u
t
i
o
n

Using the power rule for differentiation we have

$$\begin{aligned} f(x) = x^3 - 2x^2 + 10 &\Rightarrow f'(x) = 3x^2 - 4x \\ \therefore f'(3) &= 3 \times 3^2 - 4 \times 3 \\ &= 15 \end{aligned}$$

Notice how much more efficient this is compared to using $f'(3) = \lim_{h \rightarrow 0} \frac{f(3+h) - f(3)}{h}$

EXAMPLE 19.10

Find the gradient of the curve with equation $y = 9x - x^3$ at the point (2, 10).

**S
o
l
u
t
i
o
n**

First, find the equation that gives the gradient at any point on the curve, that is, find $\frac{dy}{dx}$.

Using the power rule we have, $y = 9x - x^3 \Rightarrow \frac{dy}{dx} = 9 - 3x^2$. Substituting $x = 2$ into the derivative equation, $\frac{dy}{dx} = 9 - 3(2)^2 = -3$. i.e., the gradient at the point (2, 10) is -3 .

EXAMPLE 19.11

Determine the coordinate(s) on the curve $x \mapsto x^3 - x + 2$ where the gradient is 11.

**S
o
l
u
t
i
o
n**

Let $f(x) = x^3 - x + 2$, we need to find values of x for which $f'(x) = 11$:

We have that $f'(x) = 3x^2 - 1$, so that $3x^2 - 1 = 11 \Leftrightarrow 3x^2 - 12 = 0$

$$\Leftrightarrow 3(x^2 - 4) = 0$$

$$\Leftrightarrow 3(x - 2)(x + 2) = 0$$

$$x = 2 \text{ or } x = -2$$

For $x = 2$, $f(2) = 8$ and for $x = -2$, $f(-2) = -4$.

Therefore, the required coordinates are (2, 8) and (-2, -4).

Notice that it is possible for a curve to have the same gradient at different points.

EXAMPLE 19.12

Given that $f(x) = x^3 - x^2 - x + 1$, find the coordinates of all points for which the curve with equation $y = f(x)$ has a horizontal tangent.

**S
o
l
u
t
i
o
n**

If the tangent at a point on the curve is horizontal then the gradient of the curve at that point must be zero. So, to find those values of x where $f'(x) = 0$.

Now, $f'(x) = 3x^2 - 2x - 1 \therefore f'(x) = 0 \Leftrightarrow 3x^2 - 2x - 1 = 0$

$$\Leftrightarrow (3x + 1)(x - 1) = 0$$

$$\Leftrightarrow x = -\frac{1}{3} \text{ or } x = 1$$

For $x = -\frac{1}{3}$, $y = f\left(-\frac{1}{3}\right) = -\frac{1}{27} - \frac{1}{9} + \frac{1}{3} + 1 = \frac{32}{27}$ and for $x = 1$, $y = 1 - 1 - 1 + 1 = 0$.

So, the relevant points are $\left(-\frac{1}{3}, \frac{32}{27}\right)$ and (1, 0).

We now make use of a graphics calculator to find the gradient at a particular point on a curve.

EXAMPLE 19.13

Use a graphics calculator to solve Example 19.10.

Solution

Using the TI-83 we first enter the equation, $y = 9x - x^3$ into the equation screen. Then we **QUIT** and have a blank screen. At this stage we select **MATH** and use the down arrow to select option **8:nDeriv(**, we now call up the **VARS** screen. Using the arrows, select **Y-VARS**. Next select option **1:Function** followed by option **1:Y1** and then press **ENTER**. At this stage we have a screen displaying **nDeriv(Y1**. Next we enter our parameters, **,X, 2)** – dont forget the commas. The 'X' informs the calculator that the variable in question is 'X' and the '2' informs the calculator that we wish to evaluate the derivative at ' $x = 2$ '. The screen sequence is now displayed:

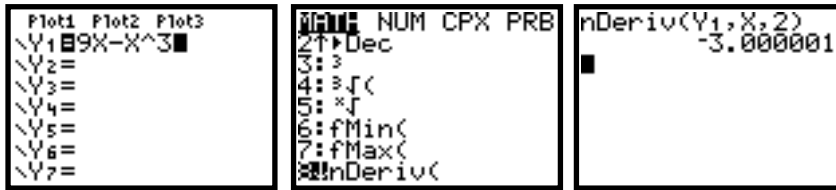

Notice that the answer we have obtained is -3.000001 (which, for all intended purposes is -3). The reason lies in our original 'accuracy' settings on the calculator – see your graphics calculator handbook for more details on this.

Note in this case it would have been easier to have entered the information on the one screen as follows:

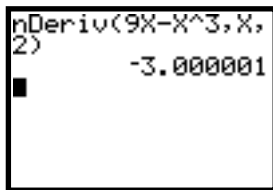

That is, type in the equation into the **nDeriv(** function as opposed to using the **VARS** approach. However, you should spend some time in considering when one approach is more beneficial than the other.

EXERCISES 19.2.1

1. Let P and Q be points on the curve $y = x^2 - 4x$ for which $x = 4$ and $x = 4 + h$ respectively. Express the gradient of PQ in terms of h and hence find the gradient of the curve $y = x^2 - 4x$ at $x = 4$.
2. For a curve with equation $y = \frac{2}{x+1}$ determine the coordinates of the points P and Q where $x = 1$ and $x = 1 + h$ respectively. Express the gradient of the line PQ in terms of h and hence find the gradient of the curve at $x = 1$.
3. Using a first principles method find the gradient of the curve with equation $y = 6 - x^3$ at the point where $x = 2$.

- 4.** Find the gradient of the function at the indicated point.
- (a) $f(x) = x^3 - 2$ at $(1, -1)$ (b) $f(x) = \frac{1}{x}$ at $(2, 0.5)$
- (c) $f(x) = (2x - 1)^2$ at $(2, 9)$ (d) $y = (2x + 1)^2$ at $(0, 1)$
- (e) $y = x^2 - \frac{1}{x^2} + 2$ at $(1, 2)$ (f) $y = \sqrt[3]{x^2} - \sqrt{x} + x$ at $(1, 1)$
- (g) $f(x) = 1 - \sqrt[3]{x}$ at $(8, -1)$ (h) $y = x\sqrt{x} + \frac{x}{\sqrt{x}} - \frac{\sqrt{x}}{x}$ at $(4, \frac{19}{2})$
- 5.** Find the value(s) of x , so that $f'(x) = 0$ given that $f(x) = x^3 - 8x$.
- 6.** For the curve with equation $y = x^2 - 12x$, find:
- (a) $\frac{dy}{dx}$ (b) the gradient where $x = -3$
- (c) the coordinates of the point where the gradient is 4.
- 7.** For the curve with equation $y = -x^3 + 3x$, find:
- (a) $\frac{dy}{dx}$ (b) the gradient where $x = 1$
- (c) the coordinates of the point where the gradient is -3 .
- 8.** For the curve with equation $f(x) = \frac{1}{4}x^2(x^2 - 1)$, find:
- (a) the coordinates where its gradient is zero.
- (b) the set of values of x for which its gradient is positive.
- 9.** Determine those values of x for which the curve with equation $y = 8 - x^2$ will have the same gradient as the curve with equation $y = x^3 - x$.
- 10.** Find the gradient of the function $x: \mapsto x^3 + x^2 - 2x$ at the points where
- (a) it crosses the x -axis,
- (b) it cuts the y -axis.
- 11.** The curve with equation $y = ax + \frac{b}{x^2}$ passes through the point $(2, 0)$, where its gradient is found to be 3. Determine the values of a and b .
- 12.** Given that $g(x) = x^2$, show that $f'(a + b) = f'(a) + f'(b)$.
- 13.** Given that $h(x) = 4x - 2\sqrt{x}$, $x \geq 0$, find (a) $f(a^2)$ (b) $f'(a^2)$.
- 14.** The function $f(x) = ax^3 - bx^2$ has a gradient of 2 at the point $(1, 6)$. Find its gradient when $x = 2$.
- 15.** Given that $f(x) = \frac{1}{x^n}$, show that $xf'(x) + nf(x) = 0$.

19.2.2 GRADIENT FUNCTION FROM A GRAPH

We now have a brief look at some geometrical properties of the gradient value $f'(a)$ at a point $(a, f(a))$ of the graph $y = f(x)$.

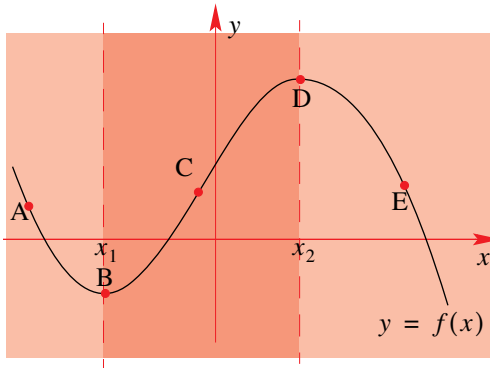

1. At A, tangent has a negative slope.
2. For $x < x_1$ gradient is < 0 , i.e., $g'(x) < 0$.
3. At B, tangent is a horizontal line. Meaning that it has a gradient of zero.
4. At $x = x_1$ gradient is zero, i.e., $g'(x_1) = 0$.
5. At C, tangent has a positive slope.
6. For $x_1 < x < x_2$ gradient is positive.
7. At D, tangent is a horizontal line. Meaning that it has a gradient of zero.
8. At $x = x_2$ gradient is zero, i.e., $g'(x_2) = 0$.
9. For $x > x_2$ gradient is negative.
10. At E, tangent has a negative slope.

These properties are extremely useful in helping us ‘find’ and/or ‘sketch’ the gradient function of a graph when the equation of the function is not provided.

EXAMPLE 19.14

Sketch the graph of the gradient function of the curves shown below.

(a)

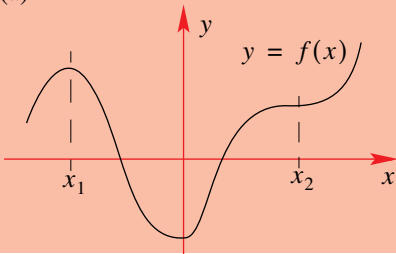

(b)

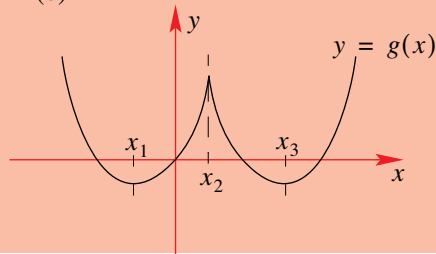

S
O
L
U
T
I
O
N

A general approach to these types of problems is to first locate where a horizontal tangent line would occur on the curve. Once the point(s) have been located we can then ‘break up’ the remainder of the curve into appropriate regions. e.g., regions of positive gradients, regions of negative gradients and so on.

(a) In this case, our ‘key’ points occur when $x = x_1$, $x = x_2$ and $x = 0$. At each of these points the gradient is zero. We observe that for $x < x_1$, $0 < x < x_2$ and $x > x_2$ the gradient is positive. Also, for $x_1 < x < 0$ the gradient is negative. We start by identifying these regions on the set of axes defining $f'(x)$ versus x – this will show us where we can sketch the gradient function.

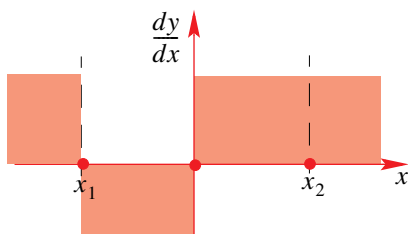

All that remains is to ‘identify’ the gradient values along the curve. By ‘identify’ we mean determine the relative gradient values. That is, the region where the gradient has been identified as being either positive or negative. As we move along the curve (from left to right) are the gradient values increasing or decreasing? As you move along the curve, keep asking yourself questions like, “Is the gradient value becoming more and more positive?”, “Is the gradient value becoming more and more negative?”, “Is the gradient becoming smaller and smaller?” and so on.

These questions can be more easily answered if you use a ruler or pencil and run it along the curve from left to right.

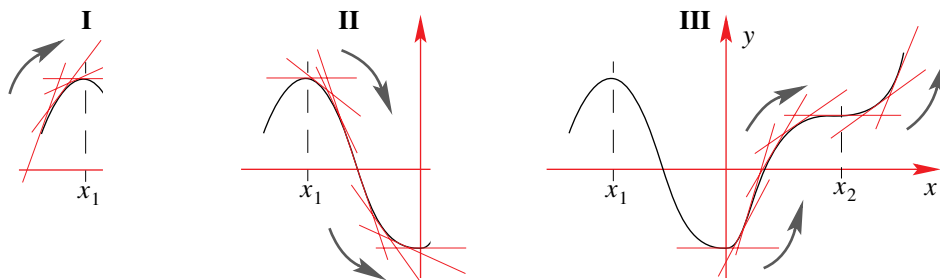

Section I ($x < x_1$):

Positive gradient that is decreasing in value as we get closer to x_1 .

Section II ($x_1 < x < 0$):

Negative gradient becomes more and more negative, then, while still remaining negative, the gradient value becomes less and less negative until it reaches a value of zero at $x = 0$.

Section III ($x > 0$):

Positive gradient becomes more and more positive, then, while still remaining positive, the gradient value becomes less and less positive until it reaches a value of zero at $x = x_2$. As we continue along the curve, the gradient value remains positive and becomes more and more positive.

Combining all of our findings we can produce the following sketch of the gradient function:

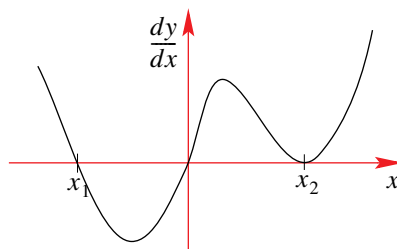

Realise that we are not so much interested in the numerical values of the gradient function but rather the general shape of the gradient function.

(b) Using the same approach we first determine the ‘regions’ where the gradient function lies (i.e., where it is positive and where it is negative).

- I. For $x < x_1$, $g'(x) < 0$.
- II. At $x = x_1$, $g'(x) = 0$.
- III. For $x_1 < x < x_2$, $g'(x) > 0$.
- IV. At $x = x_2$ the gradient value cannot be found.
- V. For $x_2 < x < x_3$, $g'(x) < 0$.
- VI. At $x = x_3$, $g'(x) = 0$.
- VI. For $x > x_3$, $g'(x) > 0$.

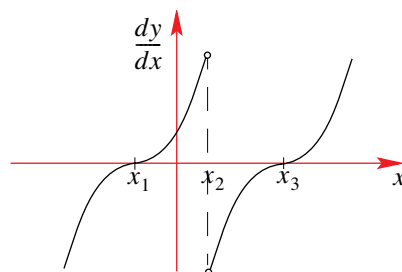

MATHEMATICS – Higher Level (Core)

Notice that at $x = x_2$ the curve finishes in a peak. Trying to place a tangent at a point such as this is not possible – i.e., approaching $x = x_2$ from the left and from the right provides two different tangents that will not coincide as we get closer and closer to $x = x_2$. In order for a gradient-value to exist at $x = a$ (say) one of the conditions is that the tangents (as we approach $x = a$) from the left and from the right must coincide. This reinforces the need to understand that

$\lim_{h \rightarrow 0} \frac{f(a+h) - f(a)}{h}$ exists if and only if $\lim_{h \rightarrow 0^+} \frac{f(a+h) - f(a)}{h} = \lim_{h \rightarrow 0^-} \frac{f(a+h) - f(a)}{h}$, i.e., the right-hand side limit equals the left-hand side limit.

EXERCISES 19.2.2

1. For each of the following functions, sketch the corresponding gradient function.

(a)

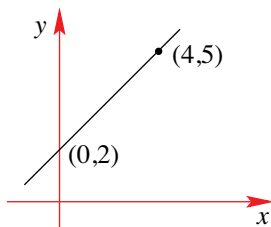

(b)

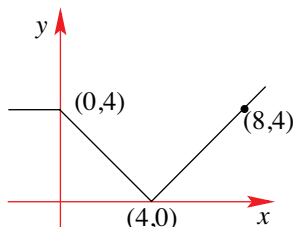

(c)

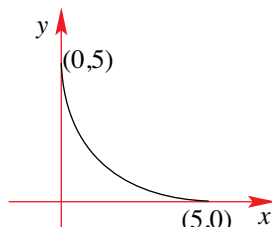

(d)

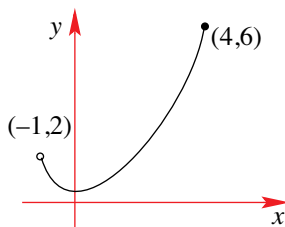

(e)

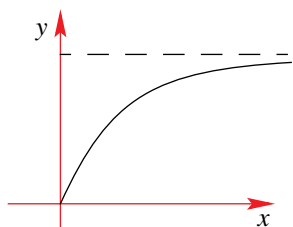

(f)

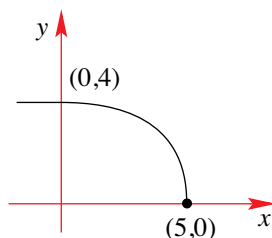

(g)

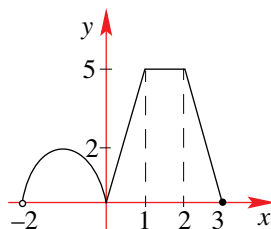

(h)

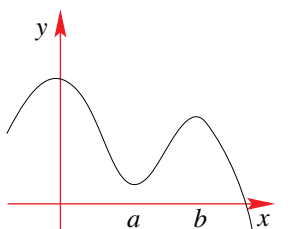

(i)

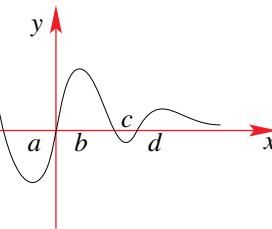

2. Sketch the graph of the function $f(x)$ given that $f(1) = 0$, $f'(x) = -1$ for all real x .

3. Sketch the graph of $f: \mathbb{R} \rightarrow \mathbb{R}$ given that $f(2) = 2$, $f'(2) = 0$, $f(1) = 4$, $f'(1) = 0$, $f'(x) > 0$ for $x > 2$ and $x < 1$ and $f'(x) < 0$ for $1 < x < 2$.

19.2.3 DIFFERENTIATING WITH VARIABLES OTHER THAN x AND y

Although it was convenient to establish the underlying theory of differentiation based on the use of the variables x and y , it must be pointed out that not all expressions are written in terms of x and y . In fact, many of the formulae that we use are written in terms of variables other than x and y , e.g., volume, V , of a sphere is given by $V = \frac{4}{3}\pi r^3$, where r is its radius. The displacement of a particle moving with constant acceleration is given by $s = ut + \frac{1}{2}at^2$. However, it is reassuring to know that the rules are the same regardless of the variables involved. Thus, if we have that y is a function of x , we can differentiate y with respect to (w.r.t) x to find $\frac{dy}{dx}$. On the other hand, if we have that y is a function of t , we would differentiate y w.r.t. t and write $\frac{dy}{dt}$. Similarly, if W was a function of θ , we would differentiate W w.r.t. θ and write $\frac{dW}{d\theta}$.

EXAMPLE 19.15

Differentiate the following with respect to the appropriate variable

(a) $V = \frac{4}{3}\pi r^3$

(b) $p = 3w^3 - 2w + 20$

(c) $s = 10t + 4t^2$

S
o
l
u
t
i
o
n

(a) As V is a function of r , we need to differentiate V with respect to r :

$$V = \frac{4}{3}\pi r^3 \Rightarrow \frac{dV}{dr} = \frac{4}{3}\pi(3r^2) = 4\pi r^2.$$

(b) This time p is a function of w , and so we would differentiate p with respect to w :

$$p = 3w^3 - 2w + 20 \Rightarrow \frac{dp}{dw} = 9w^2 - 2.$$

(c) In this expression we have that s is a function of t and so we differentiate s w.r.t t :

$$s = 10t + 4t^2 \Rightarrow \frac{ds}{dt} = 10 + 8t.$$

EXERCISES 19.2.3

1. Differentiate the following functions with respect to the appropriate variable.

(a) $s = 12t^4 - \sqrt{t}$ (b) $Q = \left(n + \frac{1}{n^2}\right)^2$ (c) $P = \sqrt{r}(r + \sqrt[3]{r} - 2)$

(d) $T = \frac{(\theta - \sqrt{\theta})^3}{\theta}$ (e) $A = 40L - L^3$ (f) $F = \frac{50}{v^2} - v$

(g) $V = 2l^3 + 5l$ (h) $A = 2\pi h + 4h^2$ (i) $N = n^4 - \sqrt[3]{n} + \pi n$

2. Differentiate the following with respect to the independent variable.

$$(a) \quad v = \frac{2}{3}\left(5 - \frac{2}{t^2}\right) \quad (b) \quad S = \pi r^2 + \frac{20}{r} \quad (c) \quad q = \sqrt{s^5} - \frac{3}{s}$$

$$(d) \quad h = \frac{2-t+t^2}{t^3} \quad (e) \quad L = \frac{4-\sqrt{b}}{b} \quad (f) \quad W = (m-2)^2(m+2)$$

19.3 DERIVATIVE OF TRANSCENDENTAL FUNCTIONS

A **transcendental function** is a function that cannot be constructed in a finite number of steps from elementary functions and their inverses. Some examples of these functions are $\sin x$, $\cos x$, $\tan x$, the exponential function, e^x and the logarithmic function $\log_e x$ (or $\ln x$).

Also in this section we look at derivatives of expressions that involve the **product** of two functions, the **quotient** of two functions and the **composite** of two functions. Each of these types of expressions will lead to some standard rules of differentiation.

19.3.1 DERIVATIVE OF CIRCULAR TRIGONOMETRIC FUNCTIONS

We begin by considering the trigonometric functions, i.e., the sine, cosine and tangent functions. There are a number of approaches that can be taken to achieve our goal. In this instance we will use two different approaches to find the derivative of the function $x \mapsto \sin(x)$.

Method 1 (A limits approach):

Letting $f(x) = \sin(x)$ and using the definition from first principles we have

$$\begin{aligned} f'(x) &= \lim_{h \rightarrow 0} \frac{f(x+h) - f(x)}{h} \\ &= \lim_{h \rightarrow 0} \frac{\sin(x+h) - \sin(x)}{h} \end{aligned}$$

It is not immediately obvious what this limit is, however, we can simplify this expression using the trigonometric identities that we have looked at in Chapter 10 and then make use of some algebra. We provide a full account of how to derive the result in §19.8. At this stage we simply quote the result.

$$f(x) = \sin(x) \text{ then } f'(x) = \cos(x)$$

Method 2 (Using the graph of the original function):

We will deduce the derivative of $\sin(x)$ by using its graph and the methods employed in Section 19.2.2.

We begin by sketching a graph of $f(x) = \sin(x)$ and by measuring its gradient (m) along different points on the curve. To do this we draw a tangent at each of these points and then measure the gradient of the tangent. Next we plot the values of the gradient that we obtain at each of these points. This in turn will provide us with the values of the gradient function. Plotting these values (as shown in the diagram alongside) will then produce a rough sketch of the gradient function (and hence the derivative). From the plot of the gradient values we can reasonably assume that the gradient function obtained corresponds to the cosine function.

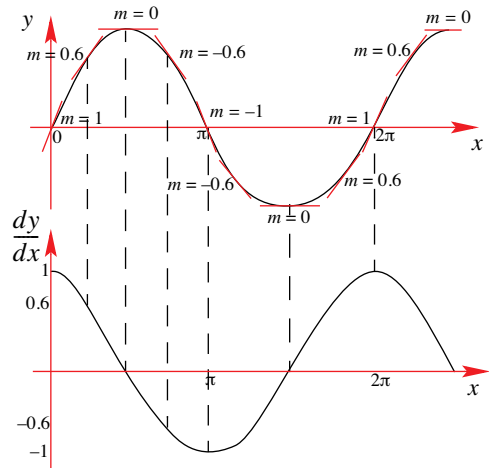

This is consistent with our earlier result (based on a limits approach). So, again we have that if $f(x) = \sin(x)$ then $f'(x) = \cos(x)$.

Similarly, using either approaches, we have that if

$$f(x) = \cos(x) \text{ then } f'(x) = -\sin(x)$$

and if

$$f(x) = \tan(x) \text{ then } f'(x) = \sec^2(x)$$

The derivative of other trigonometric functions can also be obtained in the same way, however, we will use other results that will make this process easier. Next, we consider the exponential function.

19.3.2 DERIVATIVE OF THE EXPONENTIAL FUNCTION

Consider the exponential function $x \mapsto e^x$. Although we could apply the same graphical method which was used to determine the derivative of the sine function, this time we shall make use of the definition of the derivative, i.e.,

$$\begin{aligned} f'(x) &= \lim_{h \rightarrow 0} \frac{f(x+h) - f(x)}{h} \\ &= \lim_{h \rightarrow 0} \frac{e^{x+h} - e^x}{h} \\ &= \lim_{h \rightarrow 0} \frac{e^x e^h - e^x}{h} \text{ using } e^x e^h = e^{x+h} \\ &= \lim_{h \rightarrow 0} \frac{e^x(e^h - 1)}{h} \\ &= e^x \lim_{h \rightarrow 0} \frac{(e^h - 1)}{h} \\ &= e^x \times 1 \\ &= e^x \end{aligned}$$

To determine the value of the limit we make use of a table of values. e.g., for $h = 0.01$, we have that

$$\frac{e^{0.01} - 1}{0.01} = \frac{0.01005}{0.01} = 1.005$$

As we use smaller values of h , this ratio will become closer to one.

Notice that this is the only function which has a derivative that is the same as itself. That is,

$$\text{if } f(x) = e^x \text{ then } f'(x) = e^x$$

19.3.3 DERIVATIVE OF THE NATURAL LOG FUNCTION

Consider the function $x \mapsto \log_e x$. As in the previous case, we use the definition of the derivative to establish the gradient function of $x \mapsto \log_e x$.

$$\begin{aligned} f'(x) &= \lim_{h \rightarrow 0} \frac{f(x+h) - f(x)}{h} = \lim_{h \rightarrow 0} \frac{\log_e(x+h) - \log_e(x)}{h} \\ &= \lim_{h \rightarrow 0} \frac{\log_e\left(\frac{x+h}{x}\right)}{h} \quad (\text{Using the log laws}) \end{aligned}$$

The next step is a little tricky, so we write it down first and then see how we arrive at the result.

$$= \frac{1}{x} \lim_{h \rightarrow 0} \log_e\left(1 + \frac{h}{x}\right)^{\frac{x}{h}}$$

To get to this step we proceeded as follows:

$$\frac{\log_e\left(1 + \frac{h}{x}\right)}{h} = \frac{1}{x} \cdot x \frac{\log_e\left(1 + \frac{h}{x}\right)}{h} = \frac{1}{x} \cdot \left(\frac{x}{h}\right) \log_e\left(1 + \frac{h}{x}\right) = \frac{1}{x} \cdot \log_e\left(1 + \frac{h}{x}\right)^{\frac{x}{h}}$$

Then, as the argument in the limit is h (i.e., it is independent of x) we have

$$\lim_{h \rightarrow 0} \frac{1}{x} \cdot \log_e\left(1 + \frac{h}{x}\right)^{\frac{x}{h}} = \frac{1}{x} \lim_{h \rightarrow 0} \log_e\left(1 + \frac{h}{x}\right)^{\frac{x}{h}}$$

Then, as the log function is a continuous function, we have that the limit of the log is the same as the log of the limit so that

$$\lim_{h \rightarrow 0} \log_e\left(1 + \frac{h}{x}\right)^{\frac{x}{h}} = \log_e\left[\lim_{h \rightarrow 0} \left(1 + \frac{h}{x}\right)^{\frac{x}{h}}\right]$$

However, we also have that $\lim_{h \rightarrow 0} \left(1 + \frac{h}{x}\right)^{\frac{x}{h}} = e$ and so we end up with the result that

$$\frac{1}{x} \lim_{h \rightarrow 0} \log_e\left(1 + \frac{h}{x}\right)^{\frac{x}{h}} = \frac{1}{x} \log_e e = \frac{1}{x} \times 1 = \frac{1}{x}$$

And so, we have that if

$$f(x) = \log_e x \text{ then } f'(x) = \frac{1}{x}$$

19.3.4 DERIVATIVE OF A PRODUCT OF FUNCTIONS

Many functions can be written as the product of two (or more) functions. For example, the function $y = (x^3 - 2x)(x^2 + x - 3)$ is made up of the product of two simpler functions of x . In fact, expressions such as these take on the general form $y = u \times v$ or $y = f(x) \times g(x)$ where (in this case) we have $u = f(x) = (x^3 - 2x)$ and $v = g(x) = (x^2 + x - 3)$.

To differentiate such expressions we use the **product rule**, which can be written as:

Function	Derivative
If $y = u \times v$ then	$\frac{dy}{dx} = \frac{du}{dx} \times v + u \times \frac{dv}{dx}$
If $y = f(x) \times g(x)$ then	$\frac{dy}{dx} = f'(x) \times g(x) + f(x) \times g'(x)$

EXAMPLE 19.16

Differentiate the following

- (a) $x^2 \sin(x)$ (b) $(x^3 - 2x + 1)e^x$ (c) $\frac{1}{x} \log_e(x)$

Solution

- (a) Let $y = x^2 \sin(x)$ so that $u = x^2$ and $v = \sin(x)$. So that $\frac{du}{dx} = 2x$ and $\frac{dv}{dx} = \cos(x)$.

$$\begin{aligned} \text{Using the product rule we have } \frac{dy}{dx} &= \frac{du}{dx} \times v + u \times \frac{dv}{dx} \\ &= 2x \times \sin(x) + x^2 \times \cos(x) \\ &= 2x \sin(x) + x^2 \cos(x) \end{aligned}$$

A useful method to find the derivative of a product makes use of the following table:

Function	Derivative
$u = x^2$	$\frac{du}{dx} = 2x$
$v = \sin(x)$	$\frac{dv}{dx} = \cos(x)$

$2x \sin(x)$
 $x^2 \cos(x)$
 Adding: $2x \sin(x) + x^2 \cos(x)$

- (b) Let $y = (x^3 - 2x + 1)e^x$ so that $u = (x^3 - 2x + 1)$ and $v = e^x$.

$$\text{Then, } \frac{du}{dx} = 3x^2 - 2 \text{ and } \frac{dv}{dx} = e^x.$$

$$\frac{dy}{dx} = \frac{du}{dx} \times v + u \times \frac{dv}{dx}$$

$$\begin{aligned} \text{Using the product rule: } &= (3x^2 - 2) \times e^x + (x^3 - 2x + 1) \times e^x \\ &= (3x^2 - 2 + x^3 - 2x + 1)e^x \\ &= (x^3 + 3x^2 - 2x - 1)e^x \end{aligned}$$

- (c) Let $y = \frac{1}{x} \log_e x$ with $u = \frac{1}{x}$ and $v = \log_e x$. This time set up a table:

Function	Derivative
$u = \frac{1}{x}$	$\frac{du}{dx} = -\frac{1}{x^2}$
$v = \log_e x$	$\frac{dv}{dx} = \frac{1}{x}$

$-\frac{1}{x^2} \times \log_e x$
 $\frac{1}{x} \times \frac{1}{x}$
 Adding: $\frac{dy}{dx} = -\frac{1}{x^2} \times \log_e x + \frac{1}{x} \times \frac{1}{x}$
 $= -\frac{1}{x^2} \times \log_e x + \frac{1}{x^2}$
 $= \frac{1}{x^2}(1 - \log_e x)$

19.3.5 DERIVATIVE OF A QUOTIENT OF FUNCTIONS

In the same way as we have a rule for the product of functions, we also have a rule for the quotient of functions. For example, the function

$$y = \frac{x^2}{x^3 + x - 1}$$

is made up of two simpler functions of x . Expressions like this take on the general form

$$y = \frac{u}{v} \quad \text{or} \quad y = \frac{f(x)}{g(x)}.$$

For the example shown above, we have that $u = x^2$ and $v = x^3 + x - 1$.

As for the product rule, we state the result.

To differentiate such expressions we use the **quotient rule**, which can be written as:

Function	Derivative
If $y = \frac{u}{v}$ then	$\frac{dy}{dx} = \frac{\frac{du}{dx} \times v - u \times \frac{dv}{dx}}{v^2}$
If $y = \frac{f(x)}{g(x)}$ then	$\frac{dy}{dx} = \frac{f'(x) \times g(x) - f(x) \times g'(x)}{[g(x)]^2}$

EXAMPLE 19.17

Differentiate the following

(a) $\frac{x^2 + 1}{\sin(x)}$

(b) $\frac{e^x + x}{x + 1}$

(c) $\frac{\sin(x)}{1 - \cos(x)}$

S
o
l
u
t
i
o
n

(a) We express $\frac{x^2 + 1}{\sin(x)}$ in the form $y = \frac{u}{v}$, so that $u = x^2 + 1$ and $v = \sin(x)$.

Giving the following derivatives, $\frac{du}{dx} = 2x$ and $\frac{dv}{dx} = \cos(x)$.

Using the quotient rule we have,

$$\begin{aligned} \frac{dy}{dx} &= \frac{\frac{du}{dx} \times v - u \times \frac{dv}{dx}}{v^2} \\ &= \frac{2x \times \sin(x) - (x^2 + 1) \times \cos(x)}{[\sin(x)]^2} \\ &= \frac{2x \sin(x) - (x^2 + 1) \cos(x)}{\sin^2(x)} \end{aligned}$$

(b) First express $\frac{e^x + x}{x + 1}$ in the form $y = \frac{u}{v}$, so that $u = e^x + x$ and $v = x + 1$ and

$\frac{du}{dx} = e^x + 1$ and $\frac{dv}{dx} = 1$. Using the quotient rule, we have

$$\frac{dy}{dx} = \frac{\frac{du}{dx} \times v - u \times \frac{dv}{dx}}{v^2} = \frac{(e^x + 1) \times (x + 1) - (e^x + x) \times 1}{(x + 1)^2}$$

$$\begin{aligned}
 &= \frac{xe^x + e^x + x + 1 - e^x - x}{(x+1)^2} \\
 &= \frac{xe^x + 1}{(x+1)^2}
 \end{aligned}$$

(c) Express the quotient $\frac{\sin(x)}{1 - \cos(x)}$ in the form $y = \frac{u}{v}$, so that $u = \sin(x)$

and $v = 1 - \cos(x)$. Then $\frac{du}{dx} = \cos(x)$ and $\frac{dv}{dx} = \sin(x)$.

Using the quotient rule, we have

$$\begin{aligned}
 \frac{dy}{dx} &= \frac{\frac{du}{dx} \times v - u \times \frac{dv}{dx}}{v^2} = \frac{\cos(x) \times (1 - \cos(x)) - \sin(x) \times \sin(x)}{(1 - \cos(x))^2} \\
 &= \frac{\cos(x) - \cos^2(x) - \sin^2(x)}{(1 - \cos(x))^2} \\
 &= \frac{\cos(x) - (\cos^2(x) + \sin^2(x))}{(1 - \cos(x))^2} \\
 &= \frac{\cos(x) - 1}{(1 - \cos(x))^2} \\
 &= -\frac{(1 - \cos(x))}{(1 - \cos(x))^2} \\
 &= -\frac{1}{(1 - \cos(x))}
 \end{aligned}$$

19.3.6 THE CHAIN RULE

To find the derivative of $x^3 + 1$ we let $y = x^3 + 1$ so that $\frac{dy}{dx} = 3x^2$.

Next consider the derivative of the function $y = (x^3 + 1)^2$.

We first expand the brackets, $y = x^6 + 2x^3 + 1$, and obtain $\frac{dy}{dx} = 6x^5 + 6x^2$.

This expression can be simplified (i.e., factorised), giving $\frac{dy}{dx} = 6x^2(x^3 + 1)$.

In fact, it isn't too great a task to differentiate the function $y = (x^3 + 1)^3$.

As before, we expand; $y = x^9 + 3x^6 + 3x^3 + 1$ so that $\frac{dy}{dx} = 9x^8 + 18x^5 + 9x^2$.

Factorising this expression we now have $\frac{dy}{dx} = 9x^2(x^6 + 2x^3 + 1) = 9x^2(x^3 + 1)^2$.

But what happens if we need to differentiate the expression $y = (x^3 + 1)^8$? Of course, we could expand and obtain a polynomial with 9 terms (!), which we then proceed to differentiate and obtain a polynomial with 8 terms. . . and of course, we can then easily factorise that polynomial (not!). The question then arises, "Is there an easier way to do this?"

We can obtain some idea of how to do this by summarising the results found so far:

Function	Derivative	(Factored form)
$y = x^3 + 1$	$\frac{dy}{dx} = 3x^2$	$3x^2$
$y = (x^3 + 1)^2$	$\frac{dy}{dx} = 6x^5 + 6x^2$	$2 \times 3x^2(x^3 + 1)$
$y = (x^3 + 1)^3$	$\frac{dy}{dx} = 9x^8 + 18x^5 + 9x^2$	$3 \times 3x^2(x^3 + 1)^2$
$y = (x^3 + 1)^4$	$\frac{dy}{dx} = 12x^{11} + 36x^8 + 36x^5 + 12x^2$	$4 \times 3x^2(x^3 + 1)^3$

The pattern that is emerging is that if $y = (x^3 + 1)^n$ then $\frac{dy}{dx} = n \times 3x^2(x^3 + 1)^{n-1}$.

In fact, if we consider the term inside the brackets as one function, so that the expression is actually a composition of two functions, namely that of $x^3 + 1$ and the power function we can write $u = x^3 + 1$ and $y = u^n$.

So that $\frac{dy}{du} = nu^{n-1} = n(x^3 + 1)^{n-1}$ and $\frac{du}{dx} = 3x^2$, giving the result $\frac{dy}{dx} = \frac{dy}{du} \times \frac{du}{dx}$.

Is this a ‘one-off’ result, or can we determine a general result that will always work? To explore this we use a graphical approach to see why it might be possible to obtain a general result.

We start by using the above example and then move onto a more general case. For the function $y = (x^3 + 1)^2$, we let $u = x^3 + 1$ ($= g(x)$) and so $y = u^2$ ($= f(g(x))$). We need to find what effect a small change in x will have on the function y (via u). i.e., what effect will δx have on y ?

We have a sort of **chain reaction**, that is, a small change in x , δx , will produce a change in u , δu , which in turn will produce a change in y , δy ! It is the path from δx to δy that we are interested in.

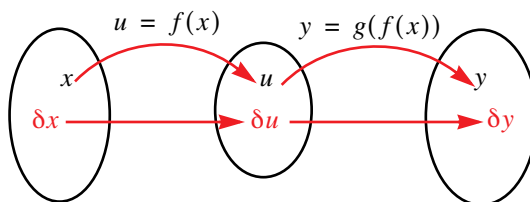

This can be seen when we produce a graphical representation of the discussion so far.

We start by looking at the effect that a change in x has on u :

Then we observe the effect that the change in u has on y :

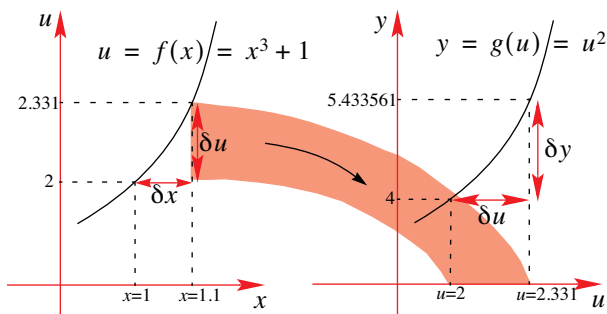

We then have $\delta x = 1.1 - 1 = 0.1$ and $\delta u = 2.331 - 2 = 0.331$.

Similarly, $\delta u = 2.331 - 2 = 0.331$ & $\delta y = 5.433561 - 4 = 1.433561$

Based on these results, the following relationship can be seen to hold:

$$\frac{\delta y}{\delta x} = \frac{\delta y}{\delta u} \times \frac{\delta u}{\delta x}$$

The basic outline in proving this result is shown in the following argument:

Let δx be a small increment in the variable x and let δu be the corresponding increment in the variable u . This change in u will in turn produce a corresponding change δy in y .

As δx tends to zero, so does δu . We will assume that $\delta u \neq 0$ when $\delta x \neq 0$. Hence we have that

$$\begin{aligned} \frac{\delta y}{\delta x} &= \frac{\delta y}{\delta u} \cdot \frac{\delta u}{\delta x} \Rightarrow \lim_{\delta x \rightarrow 0} \frac{\delta y}{\delta x} = \lim_{\delta x \rightarrow 0} \frac{\delta y}{\delta u} \cdot \frac{\delta u}{\delta x} \\ &= \left(\lim_{\delta x \rightarrow 0} \frac{\delta y}{\delta u} \right) \cdot \left(\lim_{\delta x \rightarrow 0} \frac{\delta u}{\delta x} \right) \\ &= \left(\lim_{\delta u \rightarrow 0} \frac{\delta y}{\delta u} \right) \cdot \left(\lim_{\delta x \rightarrow 0} \frac{\delta u}{\delta x} \right) \quad \text{Given that:} \\ &\quad \delta x \rightarrow 0 \Rightarrow \delta u \rightarrow 0 \\ \therefore \frac{dy}{dx} &= \frac{dy}{du} \cdot \frac{du}{dx} \end{aligned}$$

We then have the result:

$$\frac{dy}{dx} = \frac{dy}{du} \cdot \frac{du}{dx}$$

Chain rule (composite function notation)

An alternative notation when using the chain rule occurs when the function is expressed in the form of a composite function, i.e., in the form $f \circ g$.

So, if $F = f \circ g$, then $F(x) = f(g(x))$ and $F'(x) = f'(g(x)) \cdot g'(x)$.

That is, the derivative of the composite function $f \circ g$ is $(f \circ g)' = (f' \circ g)g'$, or

$$\frac{d}{dx}(f \circ g) = \frac{df}{du} \frac{du}{dx}, \text{ where } u = g(x).$$

In short, the chain rule provides a process whereby we can differentiate expressions that involve composite functions. For example, the function $y = \sin(x^2)$ is a composition of the *sine* function $\sin(\)$ and the squared function, x^2 . So that we would let u (or $g(x)$) equal x^2 , giving $y = \sin(u)$, where $u = x^2$.

The key to differentiating such expressions is to recognise that the chain rule must be used, and to choose the appropriate function u (or $g(x)$).

Using the chain rule

We will work our way through an example, showing the critical steps involved when using the chain rule.

This is highlighted by finding the derivative of the function $y = \sin(x^2)$.

Step 1	Recognition
This is the most important step when deciding if using the chain rule is appropriate. In this case we <i>recognise</i> that the function $y = \sin(x^2)$ is a composite of the sine and the squared functions.	
Step 2	Define u (or $g(x)$)
Let the ‘inside’ function be u . In this case, we have that $u = x^2$	
Step 3	Differentiate u (with respect to x)
$\frac{du}{dx} = 2x$	
Step 4	Express y in terms of u
$y = \sin(u)$	
Step 5	Differentiate y (with respect to u)
$\frac{dy}{du} = \cos(u)$	
Step 6	Use the chain rule
$\frac{dy}{dx} = \frac{dy}{du} \cdot \frac{du}{dx} = \cos(u) \times 2x = 2x \cos(x^2)$	

EXAMPLE 19.18

Differentiate the following functions (a) $y = \log_e(x + \cos x)$

(b) $f(x) = (1 - 3x^2)^4$

**S
o
l
u
t
i
o
n**

(a) Begin by letting $u = x + \cos(x) \Rightarrow \frac{du}{dx} = 1 - \sin(x)$.

Express y in terms of u , that is, $y = \log_e u \Rightarrow \frac{dy}{du} = \frac{1}{u} \left(= \frac{1}{x + \cos(x)} \right)$.

Using the chain rule we have $\frac{dy}{dx} = \frac{dy}{du} \cdot \frac{du}{dx} = \frac{1}{x + \cos(x)} \cdot (1 - \sin(x))$
 $= \frac{1 - \sin(x)}{x + \cos(x)}$

(b) This time we let $g(x) = 1 - 3x^2$, so that $g'(x) = -6x$.

Now let $f(x) = (h \circ g)(x)$ so that $h(g(x)) = (g(x))^4$ and $h'(g(x)) = 4(g(x))^3$.
 Therefore, using the chain rule we have

$$\begin{aligned} f'(x) &= (h \circ g)'(x) = h'(g(x)) \cdot g'(x) \\ &= 4(g(x))^3 \times (-6x) \\ &= -24x(1 - 3x^2)^3 \end{aligned}$$

Some standard derivatives

Often we wish to differentiate expressions of the form $y = \sin(2x)$ or $y = e^{5x}$ or other such functions, where the x term only differs by a constant factor from that of the basic function. That is, the only difference between $y = \sin(2x)$ and $y = \sin(x)$ is the factor ‘2’. We can use the chain rule to differentiate such expressions:

$$\text{Let } u = 2x, \text{ giving } y = \sin(u) \text{ and so } \frac{dy}{dx} = \frac{dy}{du} \cdot \frac{du}{dx} = \cos(u) \times 2 = 2 \cos(2x)$$

Similarly,

$$\text{Let } u = 5x, \text{ giving } y = e^u \text{ and so } \frac{dy}{dx} = \frac{dy}{du} \cdot \frac{du}{dx} = e^u \times 5 = 5e^{5x}.$$

Because of the nature of such derivatives, functions such as these form part of a set of functions that can be considered as having derivatives that are often referred to as standard derivatives. Although we could make use of the chain rule to differentiate these functions, they should be viewed as standard derivatives.

These standard derivatives are shown in the table below (where k is some real constant):

y	$\frac{dy}{dx}$
$\sin(kx)$	$k \cos(kx)$
$\cos(kx)$	$-k \sin(kx)$
$\tan(kx)$	$k \sec^2(kx)$
e^{kx}	ke^{kx}
$\log_e(kx)$	$\frac{1}{x}$

Notice, the only derivative that does not involve the constant k is that of the logarithmic function.

This is because letting $u = kx$, we have $y = \log(u)$ so $\frac{dy}{dx} = \frac{dy}{du} \cdot \frac{du}{dx} = \frac{1}{u} \times k = \frac{1}{kx} \times k = \frac{1}{x}$.

When should the chain rule be used?

A good rule of thumb:

A good **first** rule to follow is:

If the expression is made up of a pair of brackets and a power, then, the chances are that you will need to use the chain rule.

As a start, the expressions in the table that follows would require the use of the chain rule. Notice then that in each case the expression can be (or already is) written in ‘power form’. That is, of the form $y = [f(x)]^n$.

Expression	Express in power form	Decide on what u and y are
(a) $y = (2x + 6)^5$	Already in power form.	Let $u = 2x + 6$ and $y = u^5$
(b) $y = \sqrt{(2x^3 + 1)}$	$y = (2x^3 + 1)^{\frac{1}{2}}$	Let $u = 2x^3 + 1$ and $y = u^{\frac{1}{2}}$
(c) $y = \frac{3}{(x-1)^2}, x \neq 1$	$y = 3(x-1)^{-2}, x \neq 1$	Let $u = x - 1$ and $y = 3u^{-2}$
(d) $f(x) = \sin^2 x$	$f(x) = (\sin x)^2$	Let $u = \sin x$ and $f(u) = u^2$
(e) $y = \frac{1}{\sqrt[3]{e^{-x} + e^x}}$	$y = (e^{-x} + e^x)^{-\frac{1}{3}}$	Let $u = e^{-x} + e^x$ and $y = u^{-\frac{1}{3}}$

However, this isn't always the case!

Although the above approach is very useful, often you have to recognise when the function of a function rule is more appropriate. By placing brackets in the appropriate places, we can recognise this feature more readily. The examples below illustrate this:

Expression	Express it with brackets	Decide on what u and y are
(a) $y = e^{x^2 + 1}$	$y = e^{(x^2 + 1)}$	Let $u = x^2 + 1$ and $y = e^u$
(b) $y = e^{\sin 2x}$	$y = e^{(\sin 2x)}$	Let $u = \sin 2x$ and $y = e^u$
(c) $y = \sin(x^2 - 4)$	Already in bracket form.	Let $u = x^2 - 4$ and $y = \sin(u)$
(d) $f(x) = \log_e(\sin x)$	Already in bracket form.	Let $u = \sin x$ and $f(u) = \log_e(u)$

Completing the process for each of the above functions we have:

- (a) $\frac{dy}{dx} = \frac{dy du}{dudx} = e^u \times 2x = 2xe^{x^2 + 1}$.
- (b) $\frac{dy}{dx} = \frac{dy du}{dudx} = e^u \times 2 \cos(2x) = 2 \cos(2x)e^{\sin(2x)}$.
- (c) $\frac{dy}{dx} = \frac{dy du}{dudx} = \cos(u) \times 2x = 2x \cos(x^2 - 4)$.
- (d) $\frac{dy}{dx} = \frac{dy du}{dudx} = \frac{1}{u} \times \cos x = \frac{\cos x}{\sin x} = \cot x$.

We now look at some of the more demanding derivatives, i.e., derivatives which combine at least two rules of differentiation, for example, the need to use both the quotient rule and the chain rule, or the product rule and the chain rule.

EXAMPLE 19.19

Differentiate the following

- (a) $y = \sqrt{1 + \sin^2 x}$
- (b) $y = e^{x^3} \sin(1 - 2x)$
- (c) $x \mapsto \frac{x}{\sqrt{x^2 + 1}}$

**S
o
l
u
t
i
o
n**

- (a) Let $y = \sqrt{(1 + \sin^2 x)} = (1 + \sin^2 x)^{1/2}$. Using the chain rule we have
- $$\begin{aligned} \frac{dy}{dx} &= \frac{1}{2} \times \frac{d}{dx}(1 + \sin^2 x) \times (1 + \sin^2 x)^{-1/2} = \frac{1}{2} \times (2 \sin x \cos x) \times \frac{1}{\sqrt{(1 + \sin^2 x)}} \\ &= \frac{\sin x \cos x}{\sqrt{(1 + \sin^2 x)}} \end{aligned}$$
- (b) Let $y = e^{x^3} \sin(1 - 2x)$. Using the product rule first, we have
- $$\begin{aligned} \frac{dy}{dx} &= \frac{d}{dx}(e^{x^3}) \times \sin(1 - 2x) + e^{x^3} \times \frac{d}{dx}(\sin(1 - 2x)) \\ &= 3x^2 e^{x^3} \sin(1 - 2x) + e^{x^3} \times -2 \cos(1 - 2x) \\ &= e^{x^3} (3x^2 \sin(1 - 2x) - 2 \cos(1 - 2x)) \end{aligned}$$
- (c) Let $f(x) = \frac{x}{\sqrt{x^2 + 1}} \Rightarrow f'(x) = \frac{\frac{d}{dx}(x) \times \sqrt{x^2 + 1} - x \times \frac{d}{dx}(\sqrt{x^2 + 1})}{(\sqrt{x^2 + 1})^2}$ (Quotient rule).
- $$\begin{aligned} &= \frac{1 \times \sqrt{x^2 + 1} - x \times \frac{1}{2} \times 2x \times (x^2 + 1)^{-\frac{1}{2}}}{x^2 + 1} \\ &= \frac{\sqrt{x^2 + 1} - \frac{x^2}{\sqrt{x^2 + 1}}}{(x^2 + 1)} \\ &= \frac{(\sqrt{x^2 + 1})^2 - x^2}{\sqrt{x^2 + 1} (x^2 + 1)} \\ &= \frac{1}{(x^2 + 1)\sqrt{x^2 + 1}} \end{aligned}$$

EXAMPLE 19.20

Differentiate the following

- (a) $y = \ln\left(\frac{x}{x+1}\right), x > 0$ (b) $y = \sin(\ln t)$ (c) $y = x \ln(x^2)$

**S
o
l
u
t
i
o
n**

- (a) $y = \ln\left(\frac{x}{x+1}\right) = \ln(x) - \ln(x+1) \therefore \frac{dy}{dx} = \frac{1}{x} - \frac{1}{x+1} = \frac{(x+1) - x}{x(x+1)} = \frac{1}{x(x+1)}$.

Notice that using the log laws to first simplify this expression made the differentiation process much easier.

The other approach, i.e., letting $u = \frac{x}{x+1}$, $y = \ln(u)$ and then using the chain rule would have meant more work – as not only would we need to use the chain rule but also the quotient rule to determine $\frac{du}{dx}$.

- (b) Let $u = \ln t$ so that $y = \sin u$.

Using the chain rule we have $\frac{dy}{dt} = \frac{dy}{du} \cdot \frac{du}{dt} = \cos(u) \times \frac{1}{t} = \frac{\cos(\ln t)}{t}$

MATHEMATICS – Higher Level (Core)

- (c) Here we have a product $x \times \ln(x^2)$, so that the product rule needs to be used and then we need the chain rule to differentiate $\ln(x^2)$.

Notice that in this case we cannot simply rewrite $\ln(x^2)$ as $2\ln(x)$. Why?

Because the functions $\ln(x^2)$ and $2\ln(x)$ might have different domains. That is, the domain of $\ln(x^2)$ is all real values excluding zero (assuming an implied domain) whereas the domain of $2\ln(x)$ is only the positive real numbers. However, if it had been specified that $x > 0$, then we could have ‘converted’ $\ln(x^2)$ to $2\ln(x)$.

$$\text{So, } \frac{dy}{dx} = \frac{d}{dx}(x) \times \ln(x^2) + x \times \frac{d}{dx}(\ln(x^2)) = 1 \times \ln(x^2) + x \times \frac{2x}{x^2} = \ln(x^2) + 2$$

A short cut (?)

Once you have practiced the use of these rules and are confident in applying them, you can make use of the following table to speed up the use of the chain rule. Assuming that the function $f(x)$ is differentiable then we have:

y	$\frac{dy}{dx}$
$\sin[f(x)]$	$f'(x)\cos[f(x)]$
$\cos[f(x)]$	$-f'(x)\sin[f(x)]$
$\tan[f(x)]$	$f'(x)\sec^2[f(x)]$
$e^{f(x)}$	$f'(x)e^{f(x)}$
$\log_e[f(x)]$	$\frac{f'(x)}{f(x)}$
$[f(x)]^n$	$nf'(x)[f(x)]^{n-1}$

19.3.7 DERIVATIVE OF RECIPROCAL CIRCULAR FUNCTIONS

Dealing with the functions $\sec(x)$, $\cot(x)$ and $\operatorname{cosec}(x)$ is a straight forward matter – simply rewrite them as their reciprocal counterparts. That is, $\sec(x) = \frac{1}{\cos(x)}$, $\cot(x) = \frac{1}{\tan(x)}$ and $\operatorname{cosec}(x) = \frac{1}{\sin(x)}$. Once this is done, make use of the chain rule.

$$\text{For example, } \frac{d}{dx}(\operatorname{cosec}x) = \frac{d}{dx}\left(\frac{1}{\sin x}\right) = \frac{d}{dx}[(\sin x)^{-1}] = -1 \times \cos x \times (\sin x)^{-2} = -\frac{\cos x}{(\sin x)^2}.$$

We could leave the answer as is or simplify it as follows; $-\frac{\cos x}{\sin x \sin x} = -\cot x \operatorname{cosec} x$.

So, rather than providing a table of ‘standard results’ for the derivative of the reciprocal circular

trigonometric functions, we consider them as special cases of the circular trigonometric functions.

EXAMPLE 19.21

Differentiate the following

(a) $f(x) = \cot 2x, x > 0$ (b) $y = \sec^2 x$ (c) $y = \frac{\ln(\operatorname{cosec} x)}{x}$

**S
o
l
u
t
i
o
n**

(a) $f(x) = \cot 2x = \frac{1}{\tan 2x} = (\tan 2x)^{-1} \therefore f'(x) = -1 \times 2 \sec^2 2x \times (\tan 2x)^{-2}$

$$= -\frac{2 \sec^2 2x}{\tan^2 2x}$$

Now, $\frac{2 \sec^2 2x}{\tan^2 2x} = 2 \times \frac{1}{\cos^2 2x} \times \frac{1}{\tan^2 2x} = 2 \times \frac{1}{\cos^2 2x} \times \frac{\cos^2 2x}{\sin^2 2x} = 2 \operatorname{cosec}^2 2x$.

And so, $f'(x) = -2 \operatorname{cosec}^2 2x$.

(b) $y = \sec^2 x = \frac{1}{(\cos x)^2} = (\cos x)^{-2} \therefore \frac{dy}{dx} = -2 \times -\sin x \times (\cos x)^{-3} = \frac{2 \sin x}{(\cos x)^3}$.

Now, $\frac{2 \sin x}{(\cos x)^3} = 2 \times \frac{\sin x}{\cos x} \times \frac{1}{(\cos x)^2} = 2 \tan x \sec^2 x \therefore \frac{dy}{dx} = 2 \tan x \sec^2 x$.

(c) $y = \frac{\ln(\operatorname{cosec} x)}{x} = \frac{\ln[(\sin x)^{-1}]}{x} = -\frac{\ln(\sin x)}{x} \therefore \frac{dy}{dx} = -\frac{\left(\frac{\cos x}{\sin x}\right) \times x - 1 \times \ln(\sin x)}{x^2}$

$$= -\frac{x \cos x - \sin x \ln(\sin x)}{\sin x \cdot x^2}$$

$$= -\frac{x \cos x - \sin x \ln(\sin x)}{x^2 \sin x}$$

An interesting result

A special case of the chain rule involves the case $y = x$. By viewing this as an application of the chain rule $\frac{dy}{dx} = \frac{dy}{du} \cdot \frac{du}{dx}$ we have (after setting $y = x$):

$$\frac{d(x)}{dx} = \frac{dx}{du} \cdot \frac{du}{dx} \Rightarrow 1 = \frac{dx}{du} \cdot \frac{du}{dx} \text{ i.e., } \frac{dx}{du} = 1 / \frac{du}{dx}$$

This **important** result is often written in the form

$$\frac{dy}{dx} = \frac{1}{\left(\frac{dx}{dy}\right)}$$

We find that this result is very useful with problems that deal with related rates.

EXERCISES 19.3

1. Use the product rule to differentiate the following and then verify your answer by first expanding the brackets

- (a) $(x^2 + 1)(2x - x^3 + 1)$ (b) $(x^3 + x^2)(x^3 + x^2 - 1)$
 (c) $\left(\frac{1}{x^2} - 1\right)\left(\frac{1}{x^2} + 1\right)$ (d) $(x^3 + x - 1)(x^3 + x + 1)$

2. Use the quotient rule to differentiate the following

- (a) $\frac{x+1}{x-1}$ (b) $\frac{x}{x+1}$ (c) $\frac{x+1}{x^2+1}$
 (d) $\frac{x^2+1}{x^3-1}$ (e) $\frac{x^2}{2x+1}$ (f) $\frac{x}{1-2x}$

3. Differentiate the following

- (a) $e^x \sin x$ (b) $x \log_e x$ (c) $e^x(2x^3 + 4x)$
 (d) $x^4 \cos x$ (e) $\sin x \cos x$ (f) $(1 + x^2) \tan x$
 (g) $\frac{4}{x^2} \times \sin x$ (h) $x e^x \sin x$ (i) $x e^x \log_e x$

4. Differentiate the following

- (a) $\frac{x}{\sin x}$ (b) $\frac{\cos x}{x+1}$ (c) $\frac{e^x}{e^x+1}$
 (d) $\frac{\sin x}{\sqrt{x}}$ (e) $\frac{x}{\log_e x}$ (f) $\frac{\log_e x}{x+1}$
 (g) $\frac{e^x-1}{x+1}$ (h) $\frac{\sin x + \cos x}{\sin x - \cos x}$ (i) $\frac{x^2}{x + \log_e x}$

5. Differentiate the following

- (a) $e^{-5x} + x$ (b) $\sin 4x - \frac{1}{2} \cos 6x$ (c) $e^{\frac{1}{3}x} - \log_e(2x) + 9x^2$
 (d) $5 \sin(5x) + 3e^{2x}$ (e) $\tan(4x) + e^{2x}$ (f) $\cos(-4x) - e^{-3x}$
 (g) $\log_e(4x+1) - x$ (h) $\log_e(e^{-x}) + x$ (i) $\sin\left(\frac{x}{2}\right) + \cos(2x)$
 (j) $\sin(7x-2)$ (k) $\sqrt{x} - \log_e(9x)$ (l) $\log_e(5x) - \cos(6x)$

6. Differentiate the following

- (a) $\sin x^2 + \sin^2 x$ (b) $\tan(2\theta) + \frac{1}{\sin \theta}$ (c) $\sin \sqrt{x}$
 (d) $\cos\left(\frac{1}{x}\right)$ (e) $\cos^3 \theta$ (f) $\sin(e^x)$

- (g) $\tan(\log_e x)$ (h) $\sqrt{\cos(2x)}$ (i) $\cos(\sin \theta)$
 (j) $4 \sec \theta$ (k) $\operatorname{cosec}(5x)$ (l) $3 \cot(2x)$

7. Differentiate the following

- (a) e^{2x+1} (b) $2e^{4-3x}$ (c) $2e^{4-3x^2}$ (d) $\sqrt{e^x}$
 (e) $e^{\sqrt{x}}$ (f) $\frac{1}{2}e^{2x+4}$ (g) $\frac{1}{2}e^{2x^2+4}$ (h) $\frac{2}{e^{3x+1}}$
 (i) e^{3x^2-6x+1} (j) $e^{\sin(\theta)}$ (k) $e^{-\cos(2\theta)}$ (l) $e^{2\log_e(x)}$
 (m) $\frac{2}{e^{-x}+1}$ (n) $(e^x - e^{-x})^3$ (o) $\sqrt{e^{2x+4}}$ (p) e^{-x^2+9x-2}

8. Differentiate the following

- (a) $\log_e(x^2 + 1)$ (b) $\log_e(\sin \theta + \theta)$ (c) $\log_e(e^x - e^{-x})$
 (d) $\log_e\left(\frac{1}{x+1}\right)$ (e) $(\log_e x)^3$ (f) $\sqrt{\log_e x}$
 (g) $\log_e(\sqrt{x-1})$ (h) $\log_e(1-x^3)$ (i) $\log_e\left(\frac{1}{\sqrt{x+2}}\right)$
 (j) $\log_e(\cos^2 x + 1)$ (k) $\log_e(x \sin x)$ (l) $\log_e\left(\frac{x}{\cos x}\right)$

9. Differentiate the following

- (a) $x \log_e(x^3 + 2)$ (b) $\sqrt{x} \sin^2 x$ (c) $\cos^2 \sqrt{\theta}$
 (d) $x^3 e^{-2x^2+3}$ (e) $\cos(x \log_e x)$ (f) $\log_e(\log_e x)$
 (g) $\frac{x^2 - 4x}{\sin(x^2)}$ (h) $\frac{10x + 1}{\log_e(10x + 1)}$ (i) $\frac{\cos(2x)}{e^{1-x}}$
 (j) $x^2 \log_e(\sin 4x)$ (k) $e^{-\sqrt{x}} \sin \sqrt{x}$ (l) $\cos(2x \sin x)$
 (m) $\frac{e^{5x+2}}{1-4x}$ (n) $\frac{\log_e(\sin \theta)}{\cos \theta}$ (o) $\frac{x}{\sqrt{x+1}}$
 (p) $x\sqrt{x^2+2}$ (q) $(x^3+x)^3\sqrt{x+1}$ (r) $(x^3-1)\sqrt{x^3+1}$
 (s) $\frac{1}{x} \log_e(x^2+1)$ (t) $\log_e\left(\frac{x^2}{x^2+2x}\right)$ (u) $\frac{\sqrt{x-1}}{x}$
 (v) $e^{-x}\sqrt{x^2+9}$ (w) $(8-x^3)\sqrt{2-x}$ (x) $x^n \ln(x^n - 1)$

10. Find the value of x where the function $x \mapsto x e^{-x}$ has a horizontal tangent.

11. Find the gradient of the function $x \mapsto \sin\left(\frac{1}{x}\right)$, where $x = \frac{2}{\pi}$.

MATHEMATICS – Higher Level (Core)

- 12.** Find the gradient of the function $x \mapsto \log_e(x^2 + 4)$ at the point where the function crosses the y -axis.
- 13.** For what value(s) of x will the function $x \mapsto \ln(x^2 + 1)$ have a gradient of 1.
- 14.** Find the rate of change of the function $x \mapsto e^{-x^2 + 2}$ at the point $(1, e)$.
- 15.** Find (a) $\frac{d}{dx}(\sin x \cos x)$ (b) $\frac{d}{dx}(\sin x^\circ)$ (c) $\frac{d}{dx}(\cos x^\circ)$
- 16.** (a) If y is the product of three functions, i.e., $y = f(x)g(x)h(x)$, show that
$$\frac{dy}{dx} = f'(x)g(x)h(x) + f(x)g'(x)h(x) + f(x)g(x)h'(x).$$
(b) Hence, differentiate the following
- $x^2 \sin x \cos x$
 - $e^{-x^3} \sin(2x) \log_e(\cos x)$
- 17.** (a) Given that $f(x) = 1 - x^3$ and $g(x) = \log_e x$, find
- $(f \circ g)'(x)$
 - $(g \circ f)'(x)$
- (b) Given that $f(x) = \sin(x^2)$ and $g(x) = e^{-x}$, find
- $(f \circ g)'(x)$
 - $(g \circ f)'(x)$
- 18.** Given that $T(\theta) = \frac{\cos k\theta}{2 + 3 \sin k\theta}$, $k \neq 0$, determine $T'\left(\frac{\pi}{2k}\right)$.
- 19.** If $f(x) = (x - a)^m(x - b)^n$, find x such that $f'(x) = 0$.
- 20.** If $f(\theta) = \sin^m \theta \cos^n \theta$, find θ such that $f'(\theta) = 0$.
- 21.** Differentiate the following
- (a) $f(x) = \cot 4x$ (b) $g(x) = \sec 2x$ (c) $f(x) = \operatorname{cosec} 3x$
- (d) $y = \sin\left(3x + \frac{\pi}{2}\right)$ (e) $y = \cot\left(\frac{\pi}{4} - x\right)$ (f) $y = \sec(2x - \pi)$
- 22.** Differentiate the following
- (a) $\sec x^2$ (b) $\sin x \sec x$ (c) $\ln(\sec x)$
- (d) $\cot^3 x$ (e) $\frac{x}{\operatorname{cosec} x}$ (f) $\frac{\operatorname{cosec} x}{\sin x}$
- (g) $x^4 \operatorname{cosec}(4x)$ (h) $\tan 2x \cot x$ (i) $\sqrt{\sec x + \cos x}$
- 23.** Differentiate the following
- (a) $e^{\sec x}$ (b) $\sec(e^x)$ (c) $e^x \sec x$
- (d) $\cot(\ln x)$ (e) $\ln(\cot 5x)$ (f) $\cot x \ln x$
- (g) $\operatorname{cosec}(\sin x)$ (h) $\sin(\operatorname{cosec} x)$ (i) $\sin x \operatorname{cosec} x$

19.4 DERIVATIVE OF INVERSE TRIGONOMETRIC FUNCTIONS

In this section, over an appropriate domain, either expression $\text{Sin}^{-1}(x)$ or $\arcsin(x)$ can be used. Similarly for $\text{Cos}^{-1}(x)$ and $\arccos(x)$ as well as $\text{Tan}^{-1}(x)$ and $\arctan(x)$. That is,

$$\text{Sin}^{-1}(x) = \arcsin(x), -1 \leq x \leq 1,$$

$$\text{Cos}^{-1}(x) = \arccos(x), -1 \leq x \leq 1,$$

$$\text{Tan}^{-1}(x) = \arctan(x), -\infty < x < \infty.$$

It is important to keep track of how the domain of some functions is not the same as that of their derived function. For example, although the function $y = \arcsin(x)$ is defined for $-1 \leq x \leq 1$ its derived function, $\frac{dy}{dx}$ is defined for $-1 < x < 1$. i.e., the end points, $x = \pm 1$ are not included.

19.4.1 DERIVATIVE OF $\text{Sin}^{-1}(x)$

By definition, $\text{Sin}^{-1}(x)$ is defined for $x \in [-1, 1]$. We start by letting $y = \text{Sin}^{-1}(x)$, $-1 \leq x \leq 1$.

Then we have that $y = \text{Sin}^{-1}(x) \Leftrightarrow x = \sin y$, $-\frac{\pi}{2} \leq y \leq \frac{\pi}{2}$

So, $\frac{dx}{dy} = \cos y$, $-\frac{\pi}{2} \leq y \leq \frac{\pi}{2} \Rightarrow \frac{dy}{dx} = \frac{1}{\cos y}$, $-\frac{\pi}{2} < y < \frac{\pi}{2}$

Note the change in domains!

Now we express $\cos y$ back in terms of x : Using the identity $\cos^2 y + \sin^2 y = 1$ we have

$\cos^2 y = 1 - \sin^2 y \therefore \cos y = \pm \sqrt{1 - \sin^2 y} = \pm \sqrt{1 - x^2}$. So, at this stage, the derivative of

$\text{Sin}^{-1}(x)$ is given by $\frac{dy}{dx} = \pm \frac{1}{\sqrt{1 - x^2}}$, $-1 < x < 1$. However, over the interval $-\frac{\pi}{2} < y < \frac{\pi}{2}$ we

have that $\cos y$ is positive and so we only use the positive square root.

We then have the result that $\frac{dy}{dx} = \frac{1}{\sqrt{1 - x^2}}$, $-1 < x < 1$.

That is,

$$\frac{d}{dx}(\text{Sin}^{-1}x) = \frac{1}{\sqrt{1 - x^2}}, -1 < x < 1.$$

Note that we could have arrived at the same conclusion about the sign of the derivative by looking at the graph of $\text{Sin}^{-1}(x)$ for $x \in (-1, 1)$.

Using the graph of $\text{Sin}^{-1}(x)$ for $x \in (-1, 1)$, we can see that over the given interval the gradient anywhere on the curve is always positive and so we have to choose the positive square root.

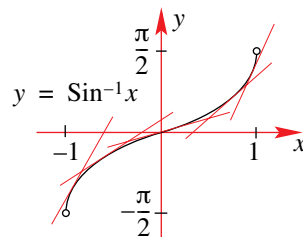

Derivative of $\text{Sin}^{-1}\left(\frac{x}{a}\right)$, $-a < x < a$ where $a > 0$

Using the chain rule for $y = \text{Sin}^{-1}\left(\frac{x}{a}\right)$, $-a \leq x \leq a$ we set $u = \frac{x}{a} \Rightarrow y = \text{Sin}^{-1}u$, $-1 \leq u \leq 1$,

which then gives $\frac{dy}{dx} = \frac{dy}{du} \cdot \frac{du}{dx} = \frac{1}{\sqrt{1-u^2}} \times \frac{1}{a} = \frac{a}{\sqrt{a^2-x^2}} \times \frac{1}{a} = \frac{1}{\sqrt{a^2-x^2}}$, $-1 < \frac{x}{a} < 1$.

Note: $\sqrt{1-u^2} = \sqrt{1-\left(\frac{x}{a}\right)^2} = \sqrt{\frac{a^2-x^2}{a^2}} = \frac{\sqrt{a^2-x^2}}{a} \therefore \frac{1}{\sqrt{1-u^2}} = \frac{a}{\sqrt{a^2-x^2}}$.

That is, $\frac{d}{dx}\left(\text{Sin}^{-1}\frac{x}{a}\right) = \frac{1}{\sqrt{a^2-x^2}}$, $-a < x < a$

19.4.2 DERIVATIVE OF $\text{Cos}^{-1}(x)$

Starting with the principle cosine function $f(x) = \cos x$, $0 \leq x \leq \pi$ we define the inverse cosine function, $f^{-1}(x)$ as $f^{-1}(x) = \text{Cos}^{-1}(x)$, $-1 \leq x \leq 1$. Letting $y = f^{-1}(x)$ we have $y = \text{Cos}^{-1}(x)$, $-1 \leq x \leq 1$ so that $x = \cos y$, $0 \leq y \leq \pi$. Differentiating both sides with respect to y we have

$$\frac{dx}{dy} = -\sin y, 0 \leq y \leq \pi \Rightarrow \frac{dy}{dx} = -\frac{1}{\sin y}, 0 < y < \pi$$

Note the change in domains!

Using the trigonometric identity $\sin^2 y = 1 - \cos^2 y$ we have $\sin y = \pm\sqrt{1 - \cos^2 y} = \pm\sqrt{1 - x^2}$.

Therefore, $\frac{dy}{dx} = \frac{-1}{\pm\sqrt{1-x^2}}$, $-1 < x < 1$.

We now need to determine which sign to choose.

Using the graph of $y = \text{Cos}^{-1}(x)$, $-1 < x < 1$ we see that over this domain, the gradient is always negative and so we choose $\sqrt{1-x^2}$.

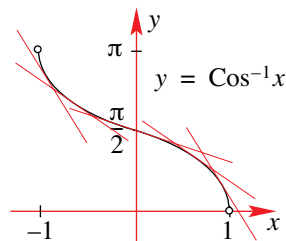

That is $\frac{d}{dx}(\text{Cos}^{-1}x) = -\frac{1}{\sqrt{1-x^2}}$, $-1 < x < 1$

Derivative of $\text{Cos}^{-1}\left(\frac{x}{a}\right)$, $-a < x < a$ where $a > 0$

Making use of the chain rule and setting $u = \frac{x}{a}$ so that $y = \text{Cos}^{-1}u$, $-1 \leq u \leq 1$ we have

$$\frac{dy}{dx} = \frac{dy}{du} \cdot \frac{du}{dx} = -\frac{1}{\sqrt{1-u^2}} \times \frac{1}{a} = -\frac{a}{\sqrt{a^2-x^2}} \times \frac{1}{a} = -\frac{1}{\sqrt{a^2-x^2}}$$
, $-1 < \frac{x}{a} < 1$.

That is $\frac{d}{dx}\left(\text{Cos}^{-1}\frac{x}{a}\right) = -\frac{1}{\sqrt{a^2-x^2}}$, $-a < x < a$

19.4.3 DERIVATIVE OF $\text{Tan}^{-1}(x)$

Again, we start with a principle tangent function $f(x) = \tan x, -\frac{\pi}{2} < x < \frac{\pi}{2}$. We define the inverse tangent function, $f^{-1}(x)$ as $f^{-1}(x) = \text{Tan}^{-1}(x), -\infty < x < \infty$. Letting $y = f^{-1}(x)$ we have $y = \text{Tan}^{-1}(x), -\infty < x < \infty$ so that $x = \tan y, -\frac{\pi}{2} < y < \frac{\pi}{2}$. Differentiating both sides with respect to y we have

$$\frac{dx}{dy} = \sec^2 y, -\frac{\pi}{2} < y < \frac{\pi}{2} \leq \frac{dy}{dx} = \frac{1}{\sec^2 y}, -\frac{\pi}{2} < y < \frac{\pi}{2}.$$

However, $\tan^2 y + 1 = \sec^2 y$, therefore $\frac{dy}{dx} = \frac{1}{1 + \tan^2 y}, -\frac{\pi}{2} < y < \frac{\pi}{2} = \frac{1}{1 + x^2}, -\infty < x < \infty$.

That is,

$$\frac{d}{dx}(\text{Tan}^{-1}x) = \frac{1}{1 + x^2}, -\infty < x < \infty$$

Derivative of $\text{Tan}^{-1}\left(\frac{x}{a}\right), -\infty < x < \infty$ where $a > 0$

Substituting $u = \frac{x}{a}$ into $y = \text{Tan}^{-1}\left(\frac{x}{a}\right), -\infty < x < \infty$ we have $y = \text{Tan}^{-1}u, -\infty < u < \infty$ so that

$$\frac{dy}{dx} = \frac{dy}{du} \cdot \frac{du}{dx} = \frac{1}{1 + u^2} \times \frac{1}{a} = \frac{a}{a^2 + x^2}, -\infty < x < \infty.$$

That is,

$$\frac{d}{dx}\left(\text{Tan}^{-1}\frac{x}{a}\right) = \frac{a}{a^2 + x^2}, -\infty < x < \infty$$

19.4.4 GENERALISATIONS FOR THE DERIVATIVE OF THE INVERSE CIRCULAR FUNCTIONS

As for the case when we obtained generalised results for the standard derivatives, we can also obtain generalised results for the derivatives of the inverse circular functions. This is done by making use of the chain rule. We derive one result and then quote the others.

Consider the function $y = \arcsin[f(x)], -1 < f(x) < 1$, then, letting $u = f(x)$, so that

$y = \arcsin(u)$ we have $\frac{dy}{dx} = \frac{dy}{du} \cdot \frac{du}{dx} = \frac{1}{\sqrt{1 - u^2}} \times f'(x)$ so that

$$\frac{d}{dx}(\arcsin[f(x)]) = \frac{f'(x)}{\sqrt{1 - [f(x)]^2}}, -1 < f(x) < 1$$

Similarly, we have the following results

$$\frac{d}{dx}(\arccos[f(x)]) = -\frac{f'(x)}{\sqrt{1 - [f(x)]^2}}, -1 < f(x) < 1$$

$$\frac{d}{dx}(\arctan[f(x)]) = \frac{f'(x)}{1 + [f(x)]^2}, -\infty < f(x) < \infty$$

EXAMPLE 19.22

Differentiate the following and specify the domain of the derivative

(a) $f(x) = \arcsin\left(\frac{x}{2}\right)$ (b) $y = \arctan(x+2)$ (c) $y = \arccos(x^2-9)$

S
o
l
u
t
i
o
n

(a) Let $u = \frac{x}{2}$ so that $f(x) = \arcsin(u)$ and as $-1 \leq u \leq 1 \Rightarrow -2 \leq x \leq 2$. Using the chain

rule we have, $f'(x) = \frac{d}{du}(\arcsin(u)) \cdot \frac{du}{dx} = \frac{1}{\sqrt{1-u^2}} \times \frac{1}{2} = \frac{1}{\sqrt{1-\left(\frac{x}{2}\right)^2}} \times \frac{1}{2} = \frac{1}{2\sqrt{\frac{4-x^2}{4}}}$

That is, $f'(x) = \frac{1}{\sqrt{4-x^2}}, -2 < x < 2$.

Note: We could have simply used the standard result, $\frac{d}{dx}\left(\arcsin\left(\frac{x}{a}\right)\right) = \frac{1}{\sqrt{a^2-x^2}}, -a < x < a$ with $a = 2!$

(b) Using the generalised result, $\frac{d}{dx}(\arctan[f(x)]) = \frac{f'(x)}{1+[f(x)]^2}, -\infty < f(x) < \infty$ with

$f(x) = x+2$ we have $\frac{d}{dx}(\arctan[x+2]) = \frac{1}{1+[x+2]^2}, -\infty < x+2 < \infty$.

That is, $\frac{dy}{dx} = \frac{1}{1+(x+2)^2}, -\infty < x < \infty$.

(c) Using the generalised result, $\frac{d}{dx}(\arccos[f(x)]) = -\frac{f'(x)}{\sqrt{1-[f(x)]^2}}, -1 < f(x) < 1$ with

$f(x) = x^2-9$ we have $\frac{d}{dx}(\arccos[x^2-9]) = -\frac{2x}{\sqrt{1-[x^2-9]^2}}, -1 < (x^2-9) < 1$.

We now determine the domain:

$-1 < (x^2-9) < 1 \Leftrightarrow 8 < x^2 < 10$.

$\therefore x \in (-\sqrt{10}, -2\sqrt{2}) \cup (2\sqrt{2}, \sqrt{10})$.

That is,

$\frac{dy}{dx} = -\frac{2x}{\sqrt{1-[x^2-9]^2}}, x \in (-\sqrt{10}, -2\sqrt{2}) \cup (2\sqrt{2}, \sqrt{10})$

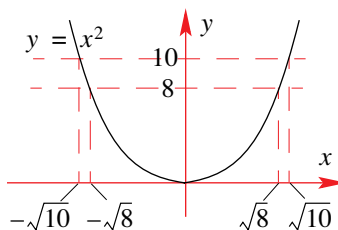

EXAMPLE 19.23

Differentiate the following and specify the domain of the derivative

(a) $f(x) = x\arcsin(2x)$ (b) $y = \sqrt{\arctan(x)}$

S
o
l
u
t
i
o
n

(a) Using the product rule we have: $f'(x) = \frac{d}{dx}(x) \times \arcsin(2x) + x \times \frac{d}{dx}[\arcsin(2x)]$

$= 1 \times \arcsin(2x) + x \times \frac{2}{\sqrt{1-(2x)^2}}, -1 < 2x < 1$

$$\therefore f'(x) = \arcsin(2x) + \frac{2x}{\sqrt{1-4x^2}}, -\frac{1}{2} < x < \frac{1}{2}$$

(b) Letting $u = \arctan(x)$ so that $y = \sqrt{u}$ and $\frac{du}{dx} = \frac{1}{1+x^2}$ we have

$$\frac{dy}{dx} = \frac{dy du}{du dx} = \frac{1}{2\sqrt{u}} \times \frac{1}{1+x^2} = \frac{1}{2(1+x^2)\sqrt{\arctan(x)}}, x > 0.$$

Notice that although the domain of $\arctan(x)$ is $-\infty < x < \infty$, the domain of $\sqrt{\arctan(x)}$ is $x \geq 0$.

However, because the derivative involves the term $\frac{1}{\sqrt{\arctan(x)}}$, then $x > 0$ (as $\arctan(0) = 0$ and we cannot divide by zero!)

EXERCISES 19.4

1. Differentiate with respect to x , each of the following

- | | | |
|---|---|--|
| (a) $\arctan(2x)$ | (b) $\arcsin\left(\frac{x}{3}\right)$ | (c) $\text{Cos}^{-1}(2x)$ |
| (d) $\text{Sin}^{-1}(4x)$ | (e) $\arctan\left(\frac{x}{2}\right)$ | (f) $\arcsin(x-1)$ |
| (g) $\arccos\left(\frac{x}{4}\right)$ | (h) $\arcsin\left(\frac{x+1}{2}\right)$ | (i) $\text{Tan}^{-1}(x-4)$ |
| (j) $\arcsin\left(\frac{2-x}{2}\right)$ | (k) $\arctan\left(\frac{2x}{3}\right)$ | (l) $\arccos\left(\frac{2x-1}{3}\right)$ |

2. Differentiate with respect to x , each of the following

- | | | |
|---------------------------------|-----------------------------------|--|
| (a) $\arctan(x^2)$ | (b) $\text{Sin}^{-1}(\sqrt{x})$ | (c) $\arccos\left(\frac{1}{\sqrt{x}}\right)$ |
| (d) $\arcsin(\cos x)$ | (e) $\arctan(\sqrt{x-1})$ | (f) $\ln(\arcsin x)$ |
| (g) $\text{Tan}^{-1}(e^x)$ | (h) $\arccos(e^{-x})$ | (i) $e^{\arcsin x}$ |
| (j) $\frac{2}{\arctan(2x)}$ | (k) $\frac{2}{\sqrt{\arcsin(x)}}$ | (l) $\frac{1}{[\arccos x]^2}$ |
| (m) $\cos(\text{Sin}^{-1}(2x))$ | (n) $\sin(\arccos(2x))$ | (o) $\tan(\arccos x)$ |

3. Differentiate with respect to x , each of the following

- | | | |
|-----------------------------|--|---|
| (a) $x\text{Tan}^{-1}x$ | (b) $\frac{\arcsin x}{x}$ | (c) $\frac{x}{\arccos x}$ |
| (d) $\frac{\arctan x}{x^2}$ | (e) $\arcsin(x^2)\ln x$ | (f) $\frac{1}{\sqrt{x}}\text{Cos}^{-1}\sqrt{x}$ |
| (g) $e^x\arctan e^x$ | (h) $(4+x^2)\arctan\left(\frac{x}{2}\right)$ | (i) $\sqrt{4-x^2}\text{Sin}^{-1}\left(\frac{x}{2}\right)$ |

MATHEMATICS – Higher Level (Core)

4. Find $\frac{dy}{dx}$ if $y = \arctan\left(\frac{x}{x+1}\right) + \arctan\left(\frac{x+1}{x}\right)$. Hence, find the real value of k , if $y = k$.
5. Show that if $y\sqrt{1-x^2} = \sin^{-1}x$, then $(1-x^2)y' = 1+xy$.
6. (a) Show that $\sin^{-1}x + \cos^{-1}x = k$, where k is a real number.
(b) Find the value of k .
7. Differentiate the following and find the implied domain for each of $f(x)$ and $f'(x)$.
- (a) $f(x) = \arcsin\left(\frac{\pi}{x}\right)$ (b) $f(x) = \cos^{-1}\left(\frac{1}{x}-1\right)$
- (c) $f(x) = (\sin^{-1}x)\left(\cos^{-1}\frac{x}{2}\right)$ (d) $f(x) = \sin^{-1}\left(\frac{1-x^2}{1+x^2}\right)$
- (e) $f(x) = \arcsin(ax)$, $a \in \mathbb{R}$ (f) $f(x) = \arcsin(2x\sqrt{1-x^2})$
- (g) $f(x) = \cos^{-1}\left(\frac{1-x^2}{1+x^2}\right)$ (h) $f(x) = \sin^{-1}\left(\frac{2x}{1+x^2}\right)$
8. Differentiate the following
- (a) $\arctan(x^n) + [\arctan(x)]^n$ (b) $\arcsin x + \arcsin\sqrt{1-x^2}$
- (c) $x\sqrt{1-x^2} + \arcsin x$ (d) $\tan^{-1}\sqrt{\frac{x-b}{a-x}}$, $b < x < a$
- (e) $\arctan[x - \sqrt{1+x^2}]$ (f) $\cot^{-1}x$
9. Given that $f: [-1, 1] \rightarrow \mathbb{R}$, where $f(x) = \arcsin(x)$ and $g(x) = \frac{1-x}{1+x}$, $x \in A$.
- (a) Find the largest set A such that $(f \circ g)(x)$ exists.
(b) Find $(f \circ g)(x)$ and state its domain.

19.5 DERIVATIVE OF a^x AND $\log_a x$

19.5.1 DIFFERENTIATING $y = a^x$

We have already considered the derivative of the natural exponential function $y = e^x$. We extend this to a more general form of the exponential function, namely, $y = a^x$, $a \neq 0, 1$. The process is straight forward, requiring an algebraic re-arrangement of $y = a^x$.

Method 1

Taking log (base e) of both sides of the equation, we have

$$y = a^x \Leftrightarrow \log_e y = \log_e a^x$$

So that,

$$\log_e y = x \log_e a$$

Next, we differentiate both sides of the equation: $\frac{d}{dx}(\log_e y) = \frac{d}{dx}(x \log_e a)$

Now (this is the tricky bit):

Using the fact that $\frac{d}{dx}(\log_e f(x)) = \frac{f'(x)}{f(x)}$ or $\frac{1}{f(x)} \times f'(x)$ and seeing as y is a function of x , we

can then write $\frac{d}{dx}(\log_e y) = \frac{1}{y} \cdot \frac{dy}{dx}$. That is, we have replaced $f(x)$ with y .

This means that we can now replace $\frac{d}{dx}(\log_e y) = \frac{d}{dx}(x \log_e a)$, with $\frac{1}{y} \cdot \frac{dy}{dx} = \frac{d}{dx}(x \log_e a)$.

Now, $\frac{d}{dx}(x \log_e a) = \log_e a \therefore \frac{1}{y} \cdot \frac{dy}{dx} = \log_e a \Leftrightarrow \frac{dy}{dx} = (\log_e a)y = (\log_e a) \times a^x$

i.e.,

$$\text{if } y = a^x \text{ then } \frac{dy}{dx} = (\log_e a) \times a^x$$

Method 2

This method uses another result that we have already encountered (Chapter 7), namely that $a^x = e^{(\log_e a)x}$, meaning that we can now write $y = a^x = e^{(\log_e a)x}$.

Letting $u = (\log_e a)x$ so that $y = e^u$ and $\frac{du}{dx} = \log_e a$, using the chain rule we have:

$$\frac{dy}{dx} = \frac{dy du}{du dx} \Rightarrow \frac{dy}{dx} = e^u \times \log_e a$$

That is, $\frac{dy}{dx} = e^{(\log_e a)x} \times \log_e a = a^x \times (\log_e a)$.

This result can be further generalised to:

$$\text{If } y = a^{kx} \text{ then } \frac{dy}{dx} = k(\log_e a) \times a^{kx}$$

EXAMPLE 19.24

Differentiate the following

(a) $y = 5 \times 2^x$

(b) $y = 3^{4x}$

(c) $y = 5^{2x+1}$

S
o
l
u
t
i
o
n

(a) Based on our result, we have that $\frac{dy}{dx} = 5 \times (\log_e 2) \times 2^x = (\log_e 32) \times 2^x$.

(b) Using the result that if $y = a^{kx}$ then $\frac{dy}{dx} = k(\log_e a) \times a^{kx}$, we have that

$$\frac{dy}{dx} = 4(\log_e 3) \times 3^{4x} = (\log_e 81) \times 3^{4x}$$

(c) Letting $u = 2x + 1$ gives $y = 5^{2x+1}$ as $y = 5^u$.

Using the chain rule we have: $\frac{dy}{dx} = \frac{dy du}{du dx} = (\log_e 5)5^u \times 2$

$$\begin{aligned}\therefore \frac{dy}{dx} &= (2\log_e 5) \times 5^{2x+1} \\ &= (\log_e 25) \times 5^{2x+1}\end{aligned}$$

Note that from $(2\log_e 5) \times 5^{2x+1}$ a number of different acceptable answers could have been given. For example, $(2\log_e 5) \times 5^{2x+1} = (2\log_e 5) \times 5^{2x} \times 5 = 10(\log_e 5) \times 5^{2x}$.

Of course we must not forget that we could have determined the derivative of $f(x) = a^x$ by using a first principles approach. That is, $f'(x) = \lim_{h \rightarrow 0} \frac{f(x+h) - f(x)}{h} = \lim_{h \rightarrow 0} \frac{a^{x+h} - a^x}{h}$.

As x is independent of the limit statement, we have $f'(x) = \lim_{h \rightarrow 0} \frac{a^x(a^h - 1)}{h} = a^x \times \lim_{h \rightarrow 0} \frac{a^h - 1}{h}$.

All that remains then is to determine $\lim_{h \rightarrow 0} \frac{a^h - 1}{h}$. We leave this as an exercise for you – however, a starting point is to use a numerical approach, i.e., try different values of a (say $a = 2$, $a = 10$) and tabulate your result for a range of (small) values of h (i.e., make h smaller and smaller). Then compare your numerical values to that of $\log_e 2$ for $a = 2$ and $\log_e 10$ for $a = 10$ and so on.

19.5.2 DIFFERENTIATING $y = \log_a x$

As in the last section, we use a simple algebraic manipulation to convert an expression for which we do not have a standard result (yet!) into one we have met before. In this case we make use of the change of base result from chapter 7.

i.e., given $\log_a x = \frac{\log_e x}{\log_e a}$ the equation $y = \log_a x$ can then be written as $y = \frac{1}{\log_e a} \times \log_e x$.

Now, $\frac{1}{\log_e a}$ is a real constant, and so, we are in fact differentiating an expression of the form

$y = k \times \log_e x$, where $k = \frac{1}{\log_e a}$. However if $y = k \times \log_e x$ then $\frac{dy}{dx} = k \times \frac{1}{x}$, meaning that

we then have:

$$\text{If } y = \log_a x \text{ then } \frac{dy}{dx} = \frac{1}{\log_e a} \times \frac{1}{x}$$

EXAMPLE 19.25

Find the derivative of

- (a) $\log_2 x$ (b) $\log_{10}(2x - 1)$ (c) $y = \log_4 \tan 8x$

S
o
l
u
t
i
o
n

(a) Given that if $y = \log_a x$ then $\frac{dy}{dx} = \frac{1}{\log_e a} \times \frac{1}{x}$ then for $y = \log_2 x$ i.e., $a = 2$ we have

$$\text{that } \frac{dy}{dx} = \frac{1}{\log_e 2} \times \frac{1}{x} = \frac{1}{(\log_e 2)x}.$$

(b) This time we start by letting $u = 2x - 1$ so that $y = \log_{10}(2x - 1) = \log_{10} u$.

Then, combining the chain rule with the results above (i.e., $a = 10$) we have:

$$\begin{aligned}\frac{dy}{dx} &= \frac{dy du}{du dx} = \left(\frac{1}{\log_e 10} \times \frac{1}{u} \right) \times 2 \\ &= \frac{2}{(\log_e 10)(2x-1)}\end{aligned}$$

(c) Again we combine the chain rule with the results of this section, where in this case, $a = 4$.

$$\text{Let } u = \tan 8x \Rightarrow \frac{du}{dx} = 8 \sec^2 8x, \text{ then } y = \log_4 u \Rightarrow \frac{dy}{du} = \frac{1}{\ln 4} \times \frac{1}{u}.$$

$$\begin{aligned}\text{Therefore, } \frac{dy}{dx} &= \frac{dy du}{du dx} = \left(\frac{1}{\ln 4} \times \frac{1}{u} \right) \times 8 \sec^2 8x = \frac{8 \sec^2 8x}{(\ln 4) \tan 8x} \\ &= \frac{8}{(\ln 4) \cos 8x \sin 8x} \\ &= \frac{8}{(\ln 2) \sin 16x}\end{aligned}$$

[using $\cos 8x \sin 8x = \frac{1}{2} \sin 16x$]

EXAMPLE 19.26

Find the derivative of

(a) $10^x \tan 2x$

(b) $\frac{2^x}{x^2}$

S
o
l
u
t
i
o
n

(a) This time we need to use the product rule, with $u = 10^x$ and $v = \tan 2x$.

$$\begin{aligned}\text{Therefore, we have that } \frac{dy}{dx} &= \frac{d}{dx}(10^x) \times \tan 2x + 10^x \times \frac{d}{dx}(\tan 2x) \\ &= (\ln 10)10^x \tan 2x + 10^x(2) \sec^2 2x \\ &= ((\ln 10) \tan 2x + 2 \sec^2 2x)10^x\end{aligned}$$

(b) Here we apply the quotient rule with $u = 2^x$, $v = x^2$ and $y = \frac{u}{v}$.

Now, $u' = \ln 2 \times 2^x$ and $v' = 2x$ so that

$$y' = \frac{u' \times v - u \times v'}{v^2} = \frac{(\ln 2 \times 2^x) \times x^2 - 2^x \times (2x)}{(x^2)^2} = \frac{2^x}{x^3}(x \ln 2 - 2).$$

19.5.3 GENERALISATION OF EXPONENTIAL AND LOGARITHMIC DERIVATIVES

We can obtain generalised versions of the rules for differentiating an exponential function and a logarithmic function. The process requires the use of the chain rule.

Exponential function

Given the function $y = a^{f(x)}$ we set $u = f(x)$ so that $y = a^u$. Then, using the chain rule we

have: $\frac{dy}{dx} = \frac{dy du}{du dx} = (\ln a)a^u \times f'(x) = f'(x)(\ln a)a^{f(x)}$.

i.e., if $y = a^{f(x)}$ then $\frac{dy}{dx} = f'(x)(\ln a)a^{f(x)}$

Logarithmic function

Given the function $y = \log_a f(x)$ we set $u = f(x)$ so that $y = \log_a u$. Then, using the chain

rule we have: $\frac{dy}{dx} = \frac{dy du}{du dx} = \frac{1}{(\ln a)} \cdot \frac{1}{u} \times f'(x) = \frac{f'(x)}{(\ln a)f(x)}$.

i.e., if $y = \log_a f(x)$ then $\frac{dy}{dx} = \frac{f'(x)}{(\ln a)f(x)}$

EXAMPLE 19.27

Find the derivative of

- (a) $5^{x^2 - \cos 2x}$ (b) $\log_k(\sqrt{\tan kx})$, where k is a positive integer.

S
o
l
u
t
i
o
n

(a) Let $y = 5^{x^2 - \cos 2x}$ so that $f(x) = x^2 - \cos 2x$ and $f'(x) = 2x + 2 \sin 2x$. Then, with

$$y = 5^{f(x)} \text{ we have } \frac{dy}{dx} = f'(x)(\ln 5)5^{f(x)} = (2x + 2 \sin 2x)(\ln 5)5^{x^2 - \cos 2x}$$

$$= 2(x + \sin 2x)(\ln 5)5^{x^2 - \cos 2x}$$

(b) Let $y = \log_k(\sqrt{\tan kx})$ so that $f(x) = \sqrt{\tan kx}$ and

$$f'(x) = \frac{1}{2} \cdot k \sec^2(kx) \cdot \frac{1}{\sqrt{\tan kx}} = \frac{k \sec^2(kx)}{2\sqrt{\tan kx}}$$

$$\frac{dy}{dx} = \frac{f'(x)}{(\ln k)f(x)} = \frac{\frac{k \sec^2(kx)}{2\sqrt{\tan kx}}}{(\ln k)\sqrt{\tan kx}} = \frac{k \sec^2(kx)}{2(\ln k)\tan kx}$$

We could simplify this expression further but at this stage we can leave it as is.

Note: We could have also started the problem by first rewriting $y = \log_k(\sqrt{\tan kx})$ as

$$y = \frac{1}{2} \log_k(\tan kx), \text{ because the implied domains of both expressions are the same.}$$

EXERCISES 19.5

1. Differentiate the following

- (a) $y = 4^x$ (b) $y = 3^x$ (c) $y = 8^x$
 (d) $y = 3 \times 5^x$ (e) $y = 7 \times 6^x$ (f) $y = 2 \times 10^x$

(g) $y = 6^{x-2}$ (h) $y = 2^{3x+1}$ (i) $y = 5 \times 7^{3-x}$

2. Differentiate the following

(a) $y = x \times 3^x$ (b) $y = 2^{x+1} \sin 2x$ (c) $y = 5^x e^{-x}$

(d) $y = \frac{x^2}{8^x}$ (e) $y = \frac{x+2}{1+4^x}$ (f) $y = \frac{\cos x}{5^{-x}}$

3. Differentiate the following

(a) $y = \log_5 x$ (b) $y = \log_{10}(5x)$ (c) $y = \log_4(2x)$

(d) $y = \log_9(x+1)$ (e) $y = \log_2(x^2+1)$ (f) $y = \log_5 \sqrt{x-5}$

(g) $y = x \log_2 x$ (h) $y = 3^x \log_3 x$ (i) $y = a^x \log_a x$

(j) $y = \frac{a^x}{\log_a x}$ (k) $y = \frac{(x+1)}{\log_{10}(x+1)}$ (l) $y = \frac{x}{\log_2 \sqrt{x}}$

4. Find the value(s) of x where the gradient of $f(x) = \frac{4^x}{x^2}$ is zero.

5. For what value(s) of x will a slope of $f(x) = x^2 \times 2^x$ be zero?

6. Given that $g(x) = x\left(\frac{1}{3}\right)^x$, find the exact value of $g'(1)$.

7. Find $h'\left(\frac{\pi}{6}\right)$ where $h(x) = \pi^{\sin x} + \sin^{\pi} x$.

8. Find where $\frac{dy}{dx} = 0$ given that $y = 10^x \log_{10} x - 10x$.

9. Find the gradient of the following curves at the point indicated

(a) $y = x^2 10^x$ at $x = 1$ (b) $y = \sin(4^x)$ at $x = 0$

(c) $y = x^e \log_{e^2} x$ at $y = 0$ (d) $y = \frac{10x}{\log_{10} x}$ at $x = 10$.

10. Differentiate the following

(a) 5^{4x+1} (b) 3^{x-x^3} (c) 10^{2x-3}

(d) $9^{\sqrt{x}-x}$ (e) $4^{\frac{1}{2} \cos 2x}$ (f) $4^{\sqrt{\cos 2x}}$

(g) $\sin(2^x)$ (h) $2^{\sin x}$ (i) $7^{\frac{1}{x}-2x}$

11. Differentiate the following

(a) $\log_2(\sin(2x))$ (b) $\log_5(\sqrt{x^2-1})$ (c) $\log_{10}(\sqrt{x}-10)$

(d) $\log_2(4-2 \tan 2x)$ (e) $\log_2(\text{Sin}^{-1} \sqrt{x})$ (f) $\log_3(\text{Tan}^{-1}(1-x))$

(g) $\log_3(x^3-3)$ (h) $\log_2(\sqrt{2-x})$ (i) $\log_{10}\left(\cos\left(\frac{x}{2}-2\right)\right)$

12. Find the derivative of

- (a) x^x (b) $x^{\sin x}$ (c) $x^{\left(\frac{1}{x}\right)}$ (d) $x^{\ln x}$

Hint: Let $y = f(x)$ and then take log base e of both sides.

19.6 SECOND DERIVATIVE

Since the derivative of a function f is another function, f' , then it may well be that this derived function can itself be differentiated. If this is done, we obtain the **second derivative** of f which is denoted by f'' and read as “***f* double dash**”.

The following notation for $y = f(x)$ is used:

First derivative $\frac{dy}{dx} = f'(x) [= y']$

Second derivative $\frac{d}{dx}\left(\frac{dy}{dx}\right) = \frac{d^2y}{dx^2} = f''(x) [= y'']$

So, for example, if $f(x) = x^3 - 5x^2 + 10$ then $f'(x) = 3x^2 - 10x$ and
 $f''(x) = 6x - 10$.

The expression $\frac{d^2y}{dx^2}$ is read as “***dee two y by dee x squared***” and the expression y'' is read as “***y double dash***”.

EXAMPLE 19.28

Find the second derivative of

- (a) $x^4 - \sin 2x$ (b) $\ln(x^2 + 1)$ (c) $x\text{Sin}^{-1}x$

**S
o
l
u
t
i
o
n**

(a) Let $y = x^4 - \sin 2x$ then $y' = 4x^3 - 2\cos 2x$ and $y'' = 12x^2 + 4\sin 2x$.

(b) Let $f(x) = \ln(x^2 + 1)$ then $f'(x) = \frac{2x}{x^2 + 1}$ and $f''(x) = \frac{2(x^2 + 1) - 2x(2x)}{(x^2 + 1)^2}$
 $= \frac{2 - 2x^2}{(x^2 + 1)^2}$

(c) Let $y = x\text{Sin}^{-1}x$ then $\frac{dy}{dx} = x \times \frac{1}{\sqrt{1-x^2}} + (1) \times \text{Sin}^{-1}x = \frac{x}{\sqrt{1-x^2}} + \text{Sin}^{-1}x$. Then,
 $\frac{d^2y}{dx^2} = \frac{(1) \times \sqrt{1-x^2} - x \times \frac{1}{2}(-2x) \cdot \frac{1}{\sqrt{1-x^2}}}{(\sqrt{1-x^2})^2} + \frac{1}{\sqrt{1-x^2}} = \frac{\sqrt{1-x^2} + \frac{x^2}{\sqrt{1-x^2}}}{1-x^2} + \frac{1}{\sqrt{1-x^2}}$
 $= \frac{\frac{1-x^2}{\sqrt{1-x^2}} + \frac{x^2}{\sqrt{1-x^2}}}{1-x^2} + \frac{1}{\sqrt{1-x^2}}$

And so,

$$\begin{aligned} \frac{d^2y}{dx^2} &= \frac{1}{\sqrt{1-x^2}} + \frac{1}{\sqrt{1-x^2}} = \frac{1}{(1-x^2)\sqrt{1-x^2}} + \frac{1}{\sqrt{1-x^2}} = \frac{1}{(1-x^2)\sqrt{1-x^2}} + \frac{1-x^2}{(1-x^2)\sqrt{1-x^2}} \\ &= \frac{2-x^2}{(1-x^2)\sqrt{1-x^2}} \end{aligned}$$

As we can see from Example 19.25 (c) some second derivatives require the use of algebra to obtain a simplified answer.

Note then that just as we can find the second derivative, so too can we determine the third derivative and the fourth derivative and so on (of course, assuming that these derivatives exist). We keep differentiating the results. The notation then is extended as follows:

Third derivative is $f'''(x)$ – “ f triple dash” and so on where the n th derivative is $f^{(n)}(x)$ or $\frac{d^n y}{dx^n}$.

EXERCISES 19.6

1. Find the second derivative of the following functions

- | | |
|---|--|
| (i) $f(x) = x^5$ | (ii) $y = (1 + 2x)^4$ |
| (iii) $f: x \mapsto \frac{1}{x}$ where $x \in \mathbb{R}$ | (iv) $f(x) = \frac{1}{1+x}$ |
| (v) $y = (x-7)(x+1)$ | (vi) $f: x \mapsto \frac{x+1}{x-2}$ where $x \in \mathbb{R} \setminus \{2\}$ |
| (vii) $f(x) = \frac{1}{x^6}$ | (viii) $y = (1-2x)^3$ |
| (ix) $y = \ln x$ | (x) $f(x) = \ln(1-x^2)$ |
| (xi) $y = \sin 4\theta$ | (xii) $f(x) = x \sin x$ |
| (xiii) $f(x) = x^3 \sin x$ | (xiv) $y = x \ln x$ |
| (xv) $f(x) = \frac{x^2-1}{2x+3}$ | (xvi) $y = x^3 e^{2x}$ |
| (xvii) $f(x) = \frac{\cos(4x)}{e^x}$ | (xviii) $y = \sin(x^2)$ |
| (xix) $f(x) = \frac{x}{1-4x^3}$ | (xx) $y = \frac{x^2-4}{x-3}$ |

2. Find the second derivative of the following

- | | | |
|----------------------------|--|--|
| (a) $\arctan x$ | (b) $\arcsin x$ | (c) $\arccos x$ |
| (d) $x \arctan x$ | (e) $\arcsin \sqrt{x}$ | (f) $\arccos\left(\frac{1}{\sqrt{x}}\right)$ |
| (g) $\frac{\arctan(x)}{x}$ | (h) $\sqrt{x} \sin^{-1}\left(\frac{x}{2}\right)$ | (i) $x \arccos(e^x)$ |

- 3.** Find the second derivative of the function $f(x) = \frac{\log_e x}{x^2}$. Find a formula for the second derivative of the function $f(x) = \frac{\log_e x}{x^n}$.
- 4.** Consider the function $f(x) = \frac{1}{x+1}$, $x \neq -1$. Find the first five derivatives by differentiating the function five times. Hypothesise a formula for the n th derivative of this function. Use the method of mathematical induction or other appropriate method to prove that your formula works for all whole numbered values of n .
- 5.** Find a formula for the second derivative of the family of functions $f(x) = \left(\frac{x+1}{x-1}\right)^n$ where n is a real number.
- 6.** Given $y = \frac{1}{1-x}$, prove that $\frac{d^n y}{dx^n} = \frac{n!}{(1-x)^{n+1}}$ for $n \geq 1$.
- 7.** Find the n th derivative of
 (a) e^{ax} (b) $y = \frac{1}{2x+1}$ (c) $\sin(ax+b)$
- 8.** (a) Find $f''(2)$ if $f(x) = x^2 - \sqrt{x}$. (b) Find $f''(1)$ if $f(x) = x^2 \tan^{-1}(x)$.
- 9.** Find the rate of change of the gradient of the function $g(x) = \frac{x^2-1}{x^2+1}$ where $x = 1$.
- 10.** Find the values of x where the rate of change of the gradient of the curve $y = x \sin x$ for $0 \leq x \leq 2\pi$ is positive.

19.7 IMPLICIT DIFFERENTIATION

19.7.1 IMPLICIT RELATIONS

Most of the equations that we have dealt with so far have been expressed in the form $y = f(x)$. For example, $y = \sin(2x) + 1$, $y = x^3 - 2x$, $y = \ln(x - e^x)$, that is, y has been expressed **explicitly** in terms of x so that for any one given value of x we obtain a unique value of y by substituting the x -value into the given equation.

Expressions such as $x^2y + y - 2 = 0$, $\sin(xy) = 1$, $e^{x+y} = x + y$, are called **implicit equations** because these equations define y **implicitly** as a function of x . Note then that although $y = x^2$ defines y as an explicit function of x , the equation $y^2 + (x + x^2)y + x^3 = 0$ defines y implicitly as functions of x – in fact, we have that two functions are defined implicitly by the equation $y^2 + (x + x^2)y + x^3 = 0$ – they are $y = -x$ and $y = -x^2$. We shall see how it is sometimes possible to extract functions from an implicit equation.

It may be possible for an implicit function to be rearranged to form an explicit function. For example, using the equation $x^2y + y - 2 = 0$ we have that $(x^2 + 1)y = 2$ and so, we obtain the equation $y = \frac{2}{x^2 + 1}$ which defines y explicitly in terms of x .

Using the implicit function $y^2 + (x + x^2)y + x^3 = 0$ we have (after expanding and grouping) that $y^2 + (x + x^2)y + x^3 = 0 \Leftrightarrow (y + x^2)(y + x) = 0 \Leftrightarrow y = -x$ or $y = -x^2$. So, we see that in this case two functions are defined implicitly by the equation $y^2 + (x + x^2)y + x^3 = 0$.

In fact with more complicated equations it might not be possible to even produce an expression for y – i.e., to solve explicitly for y . Sometimes even simple equations may not define y uniquely as a function of x – for example, if we consider the equation $e^{x+y} = x + y$ we realise that it is not possible to obtain an expression for y explicitly in terms of x .

The question then arises, “How can we differentiate equations such as these?”.

We start by considering the equation $x^2y = 2$. As y is implicitly defined as a function of x , then, one way of finding the derivative of y with respect to x is to first express y explicitly in terms of x :

So, from $x^2y = 2$ we have $y = \frac{2}{x^2} \Rightarrow \frac{dy}{dx} = -\frac{4}{x^3}$. This method works well, as long as y can be expressed explicitly in terms of x .

Now consider the equation $2x^2 + y^3 - y = 2$. This time it is not possible to express y explicitly in terms of x and so we use a procedure known as **implicit differentiation**.

The key to understanding how to find $\frac{dy}{dx}$ implicitly is to realise that we are *differentiating with respect to x* – so that terms in the equation that involve x s only can be differentiated as usual but terms that involve y s must have the chain rule applied to them (and possibly the product rule or quotient rule) because we are assuming that y is a function of x .

Before we deal with the equation $2x^2 + y^3 - y = 2$ we discuss some further examples.

To differentiate y^3 with respect to x , with the assumption that y is a function of x we use the chain rule as follows: $\frac{d}{dx}(y^3) = \frac{d}{dy}(y^3) \cdot \frac{dy}{dx} = 3y^2 \cdot \frac{dy}{dx}$.

To differentiate $\sin y$ with respect to x , with the assumption that y is a function of x we use the chain rule as follows: $\frac{d}{dx}(\sin y) = \frac{d}{dy}(\sin y) \cdot \frac{dy}{dx} = \cos y \cdot \frac{dy}{dx}$.

Notice then that to differentiate y^n with respect to x , with the assumption that y is a function of x we have:

$$\frac{d}{dx}(y^n) = \frac{d}{dy}(y^n) \cdot \frac{dy}{dx} = ny^{n-1} \cdot \frac{dy}{dx}$$

MATHEMATICS – Higher Level (Core)

To differentiate xy^2 with respect to x , with the assumption that y is a function of x we use the

$$\begin{aligned}\text{product rule and chain rule as follows: } \frac{d}{dx}(xy^2) &= \frac{d}{dx}(x) \times y^2 + x \times \frac{d}{dx}(y^2) \quad [\text{product rule}] \\ &= 1 \times y^2 + x \times \left[\frac{d}{dy}(y^2) \cdot \frac{dy}{dx} \right] \quad [\text{chain rule for } y^2] \\ &= y^2 + x \left[2y \cdot \frac{dy}{dx} \right].\end{aligned}$$

And so we have that $\frac{d}{dx}(xy^2) = y^2 + 2xy \cdot \frac{dy}{dx}$.

Now let us return to the equation $2x^2 + y^3 - y = 2$ and find the gradient of the curve at the point $(1, 1)$. We start by *differentiating both sides of the equation with respect to x* :

i.e.,
$$\frac{d}{dx}(2x^2 + y^3 - y) = \frac{d}{dx}(2)$$

Then, we differentiate each term in the expression with respect to x :

$$\frac{d}{dx}(2x^2) + \frac{d}{dx}(y^3) - \frac{d}{dx}(y) = 0$$

Use the chain rule $4x + \frac{d}{dy}(y^3) \cdot \frac{dy}{dx} - \frac{dy}{dx} = 0$

$$4x + (3y^2) \cdot \frac{dy}{dx} - \frac{dy}{dx} = 0$$

Then we group the $\frac{dy}{dx}$ terms and factorise:

$$4x + (3y^2 - 1) \frac{dy}{dx} = 0$$

Then, we solve for $\frac{dy}{dx}$:
$$\frac{dy}{dx} = -\frac{4x}{3y^2 - 1}.$$

The first thing we notice is that the derivative involves both x and y terms! Now sometimes it is possible to simplify so that there are only x terms in the expression and sometimes it can only be left as is. In this case it will be left in terms of x and y .

Then, to find the gradient of the curve at the point $(1, 1)$ we substitute the values $x = 1$ and $y = 1$ into the equation of the derivative: $\frac{dy}{dx} = -\frac{4}{3-1} = -2$

EXAMPLE 19.29

Find the derivatives of the relations:

(a) $2x^2 + xy = 5$ (b) $\frac{y}{x} + 3y^2 = 2x^3$ (c) $x \sin^{-1} y = e^{2y}$

S
O
L
U
T
I
O
N

(a) Differentiating with respect to x (which can be abbreviated to *diff. b.s.w.r.t x*):

$$\frac{d}{dx}(2x^2 + xy) = \frac{d}{dx}(5) \quad \therefore \frac{d}{dx}(2x^2) + \frac{d}{dx}(xy) = 0$$

So,
$$4x + \left[\frac{d}{dx}(x) \times y + x \times \frac{d}{dx}(y) \right] = 0 \quad [\text{Using product rule}]$$

$$\therefore 4x + \left[1 \times y + x \frac{dy}{dx} \right] = 0$$

$$\Leftrightarrow x \frac{dy}{dx} = -4x - y$$

$$\Leftrightarrow \frac{dy}{dx} = -\frac{(4x + y)}{x}$$

- (b) Here, the first term must be differentiated using the quotient rule. We consider this term on its own first. Its derivative with respect to x is:

$$\frac{d}{dx} \left(\frac{y}{x} \right) = \frac{x \times \frac{d}{dx}(y) - y \times \frac{d}{dx}(x)}{x^2} = \frac{x \times \frac{dy}{dx} - y}{x^2}$$

Then, *diff b.s.w.r.t x* we have:

$$\frac{d}{dx} \left(\frac{y}{x} + 3y^2 \right) = \frac{d}{dx} (2x^3) \Rightarrow \frac{d}{dx} \left(\frac{y}{x} \right) + \frac{d}{dx} (3y^2) = 6x^2$$

$$\therefore \frac{x \times \frac{dy}{dx} - y}{x^2} + 6y \times \frac{dy}{dx} = 6x^2$$

$$\therefore x \times \frac{dy}{dx} - y + 6x^2y \times \frac{dy}{dx} = 6x^4 \text{ [multiplying through by } x^2 \text{]}$$

$$\frac{dy}{dx} (x + 6x^2y) = 6x^4 + y \text{ [grouping the } \frac{dy}{dx} \text{ terms]}$$

$$\therefore \frac{dy}{dx} = \frac{6x^4 + y}{x + 6x^2y}$$

(c) *diff b.s.w.r.t x* : $\frac{d}{dx} (x \sin^{-1} y) = \frac{d}{dx} (e^{2y})$

[Using product rule for L.H.S and chain rule for R.H.S]

$$\frac{d}{dx} (x) \times \sin^{-1} y + x \times \frac{d}{dx} (\sin^{-1} y) = \frac{d}{dy} (e^{2y}) \frac{dy}{dx}$$

$$1 \times \sin^{-1} y + x \frac{d}{dy} (\sin^{-1} y) \frac{dy}{dx} = 2e^{2y} \frac{dy}{dx} \text{ [chain rule for } \sin^{-1} y \text{ term]}$$

$$\sin^{-1} y + \frac{x}{\sqrt{1-y^2}} \frac{dy}{dx} = 2e^{2y} \frac{dy}{dx}$$

$$\therefore \sin^{-1} y = \left(2e^{2y} - \frac{x}{\sqrt{1-y^2}} \right) \frac{dy}{dx} \text{ [grouping } \frac{dy}{dx} \text{ terms]}$$

$$\frac{dy}{dx} = \frac{\sqrt{1-y^2} (\sin^{-1} y)}{2e^{2y} \sqrt{1-y^2} - x}$$

EXAMPLE 19.30

Find $\frac{dy}{dx}$ for the relation: $x^2 + y^2 = 1$ and hence find the slope of the curve

at the point where $x = \frac{1}{2}$.

S Differentiating each term in the relation with respect to x (this can be done term by term using the linearity property of differentiation) gives:

1. The derivative of x^2 with respect to x is $2x$.
2. The derivative of y^2 with respect to x is $\frac{d}{dx}(y^2) = \frac{d}{dy}(y^2) \times \frac{dy}{dx} = 2y \frac{dy}{dx}$.

The middle step results from use of the chain rule.

3. On the right hand side, the derivative of 1 is zero.

Putting all this together, we have: $2x + 2y \frac{dy}{dx} = 0 \Leftrightarrow 2y \frac{dy}{dx} = -2x \Leftrightarrow \frac{dy}{dx} = -\frac{x}{y}$

The resulting derivative is not in terms of the independent variable, x . This does not prevent its use in finding gradients and rates of change. The second part of the question asks for the gradient of the curve at $x = \frac{1}{2}$. The first step is to use the relation to find the corresponding y coordinate:

$$x^2 + y^2 = 1 \Rightarrow \left(\frac{1}{2}\right)^2 + y^2 = 1 \Rightarrow y = \pm\sqrt{\frac{3}{4}} = \pm\frac{\sqrt{3}}{2} \text{ so } \frac{dy}{dx} = -\frac{x}{y} = \left(\frac{1}{2}\right) / \pm\frac{\sqrt{3}}{2} = \mp\frac{1}{\sqrt{3}} = \mp\frac{\sqrt{3}}{3}$$

There are two points referred to in this solution. To determine which of the two answers should be given for each point, we need to consider the fact that the relation represents a circle. The gradient at $\left(\frac{1}{2}, \frac{\sqrt{3}}{2}\right)$ is $-\frac{\sqrt{3}}{3}$ and the gradient at $\left(\frac{1}{2}, -\frac{\sqrt{3}}{2}\right)$ is $\frac{\sqrt{3}}{3}$.

Using a graphics calculator

Graphics calculators do not cope very well with implicit relations. In the above case, it would be necessary to rearrange the relation to $y = \pm\sqrt{1 - x^2}$. If the positive half of this is entered into a TI/82/3, it becomes possible to check the result using 2nd **CALC**, option 6 to obtain a decimal approximation which can be compared with the exact result. In most cases the exact result is preferred and you should not give a calculator approximation with no working!

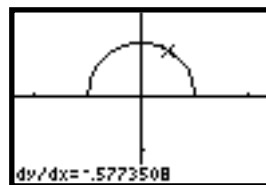

EXERCISES 19.7.1

1. Find the first derivative, $\frac{dy}{dx}$, of the following relations in which y depends on x

- | | | |
|-----------------------|--------------------------------|--------------------------------|
| (a) $2 + x^2 + y = 6$ | (b) $-3 + x^2 + y^2 = 5$ | (c) $\frac{1}{x^2} + y^2 = 14$ |
| (d) $y + xy = 9$ | (e) $4 = y + y \times e^x$ | (f) $\cos x + xy = 12$ |
| (g) $x + \ln(y) = 8$ | (h) $\frac{1}{x} + x^3y = -11$ | (i) $2x + y \sin x = 5$ |
| (j) $(x + y)^2 = 12$ | (k) $x^4 = y + y^3$ | (l) $2\sqrt{x + y} = x$ |

- 2.** $f(x)$ is a relation on a real variable x such that $e^{f(x)} - f(x) = e^5 - 5$. Find the coordinates of the point for which $x = 1$ and the gradient of the graph of the function at this point.
- 3.** A curve has equation $\frac{e^{x^2y}}{x} + 2x = 3$. Differentiate the equation implicitly and hence prove that: $\frac{e^{x^2y}}{x} = 2x + e^{x^2y} \left(2xy + x^2 \frac{dy}{dx} \right)$.
- 4.** Use implicit differentiation to find the coordinates of the points on the circle: $x^2 - 3x + y^2 - 4y = 7$ for which the gradient is 2.
- 5.** Consider the conic section with equation: $x^2 + xy - y^2 = 20$.
- Make y the subject of the equation.
 - Prove that the domain of the relation is $] -\infty, 4] \cup [4, \infty [$.
 - Find an expression for $\frac{dy}{dx}$.
 - Use (a) to eliminate y from your expression for $\frac{dy}{dx}$.
 - Hence prove that as $x \rightarrow \pm\infty$, $\frac{dy}{dx} \rightarrow \frac{5 \pm \sqrt{5}}{2\sqrt{5}}$
 - What type of curve is represented by $x^2 + xy - y^2 = 20$?
- 6.** A curve has equation $x^4 + y^4 = 16$.
- Find the domain and range of the relation.
 - Express the gradient, $\frac{dy}{dx}$, in terms of x and y .
 - Eliminate y from your expression in part (b).
 - What is the gradient in the region of the y axis?
- Consider the family of relations $x^{2n} + y^{2n} = k^{2n}$ where k is a constant and n is a positive integer
- Find the domain and range of the relation.
 - Express the gradient, $\frac{dy}{dx}$, in terms of x and y and hence describe the form of the graph of the relation as n becomes large.
- 7.**
- If $pv^Y = c$ where c and Y are real constants, find $\frac{dv}{dp}$.
 - Find $\frac{dy}{dx}$ if $\frac{x^m}{y^n} = \frac{m}{n}xy$.
- 8.** Find the slope of the curve
- $x^3 + y^3 - x^2y = 7$ at $(1, 2)$
 - $x^3 + y^3 - 3kxy = 0$ at $\left(\frac{3}{2}k, \frac{3}{2}k\right)$
- 9.** Find $\frac{dy}{dx}$ if
- $\log_e(xy) = y, x > 0$
 - $x \tan^{-1}(y) = x + y$.

10. The graph of the curve $(x^2 + y^2)^2 = 4xy^2$ is shown alongside.

- (a) Find the gradient of the curve at the point where $x = 1$. Explain your result.
- (b) Find the gradients of the curve where $y = \frac{1}{2}$, giving your answers to 2 decimal places.

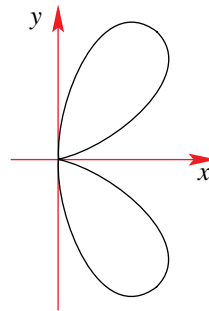

19.7.2 SECOND DERIVATIVES

It is also possible to find the second derivative of an implicit function. The process can be carried out using the following steps:

- Step 1** Find the first derivative (using the methods of section 19.7.1) – i.e., $\frac{dy}{dx} = f(x, y)$.
- Step 2** Differentiate both sides of the expression obtained in Step 1
i.e., $\frac{d}{dx}\left(\frac{dy}{dx}\right) = \frac{d}{dx}(f(x, y))$ giving $\frac{d^2y}{dx^2} = \frac{d}{dx}(f(x, y)) = g\left(x, y, \frac{dy}{dx}\right)$
- Step 3** Wherever there is a term $\frac{dy}{dx}$ in Step 2, replace it with the expression obtained in Step 1. So that $\frac{d^2y}{dx^2} = g(x, y, f(x, y))$
- Step 4** Simplify result.

EXAMPLE 19.31

Find the first and second derivatives of the relation $x^4 - y^4 = 16$

S
i
m
i
n

First, differentiate implicitly: $\frac{d}{dx}(x^4 - y^4) = \frac{d}{dx}(16) \Leftrightarrow 4x^3 - 4y^3 \frac{dy}{dx} = 0$

$$\Leftrightarrow \frac{dy}{dx} = \frac{x^3}{y^3} \quad \text{[Step 1]}$$

Next, differentiate a second time using the quotient rule. Remember that both the numerator and denominator are variables:

$$\frac{d}{dx}\left(\frac{dy}{dx}\right) = \frac{d}{dx}\left(\frac{x^3}{y^3}\right) \Rightarrow \frac{d^2y}{dx^2} = \frac{y^3 \times 3x^2 - x^3 \times 3y^2 \frac{dy}{dx}}{y^6} \quad \text{[Step 2]}$$

$$\therefore \frac{d^2y}{dx^2} = \frac{y^3 \times 3x^2 - x^3 \times 3y^2 \left(\frac{x^3}{y^3}\right)}{y^6} \quad \text{[Step 3]}$$

$$= \frac{3x^2y^4 - 3x^6}{y^7}$$

$$= \frac{3x^2(y^4 - x^4)}{y^7} \quad \text{[Step 4]}$$

However, it appears that we can further simplify this expression. We recognise as part of this

expression the term $y^4 - x^4 = -(x^4 - y^4)$. That is, the points satisfy the equation of the curve $x^4 - y^4 = 16$ so $y^4 - x^4 = -16$ and after substituting into the equation of the second derivative we obtain $\frac{d^2y}{dx^2} = \frac{3x^2(-16)}{y^7} = -\frac{48x^2}{y^7}$.

This curve can be graphed on a graphics calculator by reducing it to two explicit formulas:

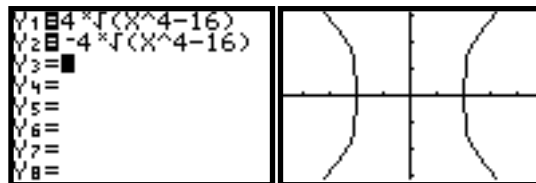

EXERCISES 19.7.2

- Find the first and second derivatives of the following relations.
 - $xy - x = 5$
 - $\frac{x^3}{y} - x = 6$
 - $x^2 + y^2 = 4$
 - $x + e^{3y} = 7$
 - $\sin 2x - \sin y + 3 = 0$
 - $\sqrt{x} + \sqrt{y} = 3$
 - $x^2 + 6xy + y^2 = -6$
 - $x^2y^2 = a^2, a \neq 0$
- Consider the relation $x^2 + \ln(x + y) = 1$.
 - Prove that the point $(1,0)$ lies on the graph of the relation.
 - Find the gradient of the graph at $(1,0)$.
 - Find the value of the second derivative at $(1,0)$.
 - Sketch the graph of the function in the region of the point $(0,1)$.
- A curve is defined by the implicit relation $x^2 - 3xy + y^2 = -1$.
 - Prove that the point $(1,1)$ lies on the graph.
 - Find the gradient of the curve at the point $(1,1)$.
 - Find the value of the second derivative at $(1,1)$.
 - Sketch the graph of the function in the region of the point $(1,1)$.
- Consider the relation $(x - 3)^2 + (y + 1)^2 = 9$.
 - State the domain and range of the relation.
 - Use implicit differentiation to find the first and second derivatives of the relation.
 - Given that the curvature of a curve is defined in the Cartesian coordinate system as:

$$\text{Curvature} = \frac{1}{\left(1 + \left(\frac{dy}{dx}\right)^2\right)^{3/2}} \cdot \left(\frac{d^2y}{dx^2}\right),$$
 prove that, over the domain found in (i), the curve has constant curvature.
- Find the rate of change of the gradient of the curve with equation $x^3 + y^3 - axy = a^3$ at the point (a, a) .

19.8 PROOFS

For the sake of completeness and to allow a certain ‘flow’ to the chapter, we use this last section to include an assortment of proofs for results which we simply quoted in the body of this chapter.

19.8.1 DERIVATIVE OF $y = x^n$ WHERE n IS A NEGATIVE INTEGER

Consider the function with equation $y = x^n$ where n is a negative integer. Setting $n = -k$, where k is a positive integers we have

$$y = x^n = x^{-k} = \frac{1}{x^k}$$

Using the quotient rule we have

$$\begin{aligned} \frac{dy}{dx} &= \frac{0 \times x^k - 1 \times kx^{k-1}}{(x^k)^2} \\ &= \frac{kx^{k-1}}{x^{2k}} \\ &= -k \cdot x^{-k-1} \end{aligned}$$

But remember, $n = -k$, so, $\frac{dy}{dx} = nx^{n-1}$.

That is, the rule is still true for negative integers.

19.8.2 DERIVATIVE OF $y = x^n$ WHERE n IS A FRACTION

Consider the function with equation $y = x^n$ where n is a fraction. Setting $n = \frac{k_1}{k_2}$, where k_1 and k_2 are positive integer we have

$$y = x^n = x^{\frac{k_1}{k_2}} \Leftrightarrow y^{k_2} = x^{k_1}.$$

Next, using implicit differentiation, we differentiate both sides with respect to x :

$$\begin{aligned} \frac{d}{dx}(y^{k_2}) &= \frac{d}{dx}(x^{k_1}) \therefore k_2 y^{k_2-1} \cdot \frac{dy}{dx} = k_1 x^{k_1-1} \\ \frac{dy}{dx} &= \frac{k_1}{k_2} \cdot \frac{x^{k_1-1}}{y^{k_2-1}} \end{aligned}$$

$$\begin{aligned} \text{As } y &= x^{\frac{k_1}{k_2}} \text{ then } y^{k_2-1} = \left(x^{\frac{k_1}{k_2}}\right)^{k_2-1} = x^{\frac{k_1(k_2-1)}{k_2}} \therefore \frac{x^{k_1-1}}{y^{k_2-1}} = \frac{x^{k_1-1}}{x^{\frac{k_1(k_2-1)}{k_2}}} = x^{k_1-1 - \left[\frac{k_1(k_2-1)}{k_2}\right]} \\ &= x^{\frac{k_1}{k_2} - 1} \end{aligned}$$

So, we have that $\frac{dy}{dx} = \frac{k_1}{k_2} x^{\frac{k_1}{k_2} - 1}$. i.e., $\frac{dy}{dx} = ny^{n-1}$.

19.8.3 PRODUCT RULE AND QUOTIENT RULE

Let $f(x)$ and $g(x)$ be two functions having derivatives $f'(x)$ and $g'(x)$, then the derivative of the product function $f(x)g(x)$ is given by $f'(x)g(x) + f(x)g'(x)$.

We will use the definition of the derivative, $(f(x)g(x))' = \lim_{h \rightarrow 0} \frac{f(x+h)g(x+h) - f(x)g(x)}{h}$.

The problem arises in trying to ‘simplify’ the numerator. The not so obvious solution to this problem is to add the expression $-f(x)g(x+h) + f(x)g(x+h)$ to the numerator.

This gives us

$$\begin{aligned} (f(x)g(x))' &= \lim_{h \rightarrow 0} \frac{f(x+h)g(x+h) + [-f(x)g(x+h) + f(x)g(x+h)] - f(x)g(x)}{h} \\ &= \lim_{h \rightarrow 0} \frac{f(x+h)g(x+h) - f(x)g(x+h)}{h} + \lim_{h \rightarrow 0} \frac{f(x)g(x+h) - f(x)g(x)}{h} \\ &= \lim_{h \rightarrow 0} \frac{f(x+h) - f(x)}{h} \cdot g(x+h) + \lim_{h \rightarrow 0} f(x) \cdot \frac{g(x+h) - g(x)}{h} \\ &= \lim_{h \rightarrow 0} \frac{f(x+h) - f(x)}{h} \cdot \lim_{h \rightarrow 0} g(x+h) + \lim_{h \rightarrow 0} f(x) \cdot \lim_{h \rightarrow 0} \frac{g(x+h) - g(x)}{h} \\ &= f'(x)g(x) + f(x)g'(x) \end{aligned}$$

We can prove the quotient rule by rewriting it as a product rule and then using the chain rule:

$$\begin{aligned} \text{Let } y &= \frac{f(x)}{g(x)} = f(x) \cdot \frac{1}{g(x)} = f(x) \cdot [g(x)]^{-1} \\ \therefore \frac{dy}{dx} &= f'(x)[g(x)]^{-1} + f(x) \times [-1 \times g'(x) \times [g(x)]^{-2}] \\ &= \frac{f'(x)}{g(x)} - \frac{f(x)g'(x)}{[g(x)]^2} \\ &= \frac{f'(x)g(x) - f(x)g'(x)}{[g(x)]^2} \end{aligned}$$

19.8.4 DERIVATIVE OF SOME TRIGONOMETRIC FUNCTIONS

The sine function

It must be pointed out at the very outset that the variable x is a real number and is given in radian measure – the proof, although carried out in the same way, would need to be altered slightly if we were considering x as being measured in degrees.

Letting $f(x) = \sin(x)$ and using the definition from first principle we have

$$f'(x) = \lim_{h \rightarrow 0} \frac{f(x+h) - f(x)}{h} = \lim_{h \rightarrow 0} \frac{\sin(x+h) - \sin(x)}{h}$$

Using the identity $\sin(A+B) = \sin A \cos B + \sin B \cos A$ we then have

$$= \lim_{h \rightarrow 0} \frac{\sin(x) \cos(h) + \sin(h) \cos(x) - \sin(x)}{h}$$

MATHEMATICS – Higher Level (Core)

$$\begin{aligned}
 &= \lim_{h \rightarrow 0} \left[\frac{\sin(x)\cos(h) - \sin(x)}{h} + \frac{\sin(h)\cos(x)}{h} \right] \\
 &= \sin(x) \lim_{h \rightarrow 0} \left[\frac{\cos(h) - 1}{h} \right] + \cos(x) \lim_{h \rightarrow 0} \frac{\sin(h)}{h} \quad (1)
 \end{aligned}$$

We now need to determine the value of the limits $\lim_{h \rightarrow 0} \left[\frac{\cos(h) - 1}{h} \right]$ and $\lim_{h \rightarrow 0} \frac{\sin(h)}{h}$.

We start with $\lim_{h \rightarrow 0} \left[\frac{\cos(h) - 1}{h} \right]$:

We have that $\lim_{h \rightarrow 0} \left[\frac{\cos(h) - 1}{h} \right] = \lim_{h \rightarrow 0} \left[\frac{\cos(h) - \cos(0)}{h - 0} \right]$ which, by definition, defines the gradient of the cosine function at $x = 0$. But, the cosine graph has a horizontal tangent at $x = 0$ and so the gradient of the cosine function at $x = 0$ must therefore be 0. Hence, the limit has a value of zero.

We are now left with determining $\lim_{h \rightarrow 0} \frac{\sin(h)}{h}$:

Using the graph of $f(h) = \frac{\sin(h)}{h}$ it is clear that the value of this limit is one.

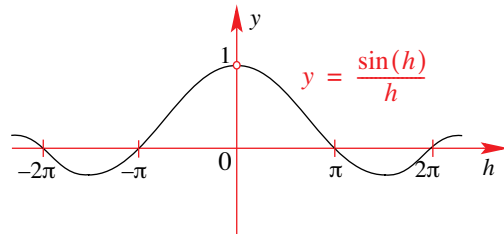

i.e., $\lim_{h \rightarrow 0} \frac{\sin(h)}{h} = 1$.

That is, although $f(0) = \frac{\sin(0)}{0}$ is undefined (hence the open circle at $(0, 1)$), the limit as h tends to zero exists!

We now continue from equation (1):

$$\begin{aligned}
 \sin(x) \lim_{h \rightarrow 0} \left[\frac{\cos(h) - 1}{h} \right] + \cos(x) \lim_{h \rightarrow 0} \frac{\sin(h)}{h} &= \sin(x) \times 0 + \cos(x) \times 1 \\
 &= \cos(x)
 \end{aligned}$$

Therefore, if $f(x) = \sin(x)$ then $f'(x) = \cos(x)$.

Note that we have used a picture to provide very strong evidence that $\lim_{h \rightarrow 0} \frac{\sin(h)}{h} = 1$. However, for those who wish to have a more rigorous proof, we now provide one:

Consider the first quadrant of a circle of unit radius.

$$\text{Area measure of } \triangle OAC = \frac{1}{2} \cdot 1 \cdot 1 \cdot \sin(h) = \frac{1}{2} \sin(h) = A_1$$

$$\text{Area measure of sector OAC} = \frac{1}{2} \cdot 1 \cdot 1 \cdot \theta = \frac{1}{2} h = A_2 \quad (\theta = h)$$

$$\text{Area measure of } \triangle OAB = \frac{1}{2} \cdot 1 \cdot \tan(h) = \frac{1}{2} \tan(h) = A_3$$

$$\text{Now, } A_1 < A_2 < A_3 \Rightarrow \frac{1}{2} \sin(h) < \frac{1}{2} h < \frac{1}{2} \tan(h)$$

$$\Leftrightarrow \sin(h) < h < \tan h \Leftrightarrow \frac{1}{\sin(h)} > \frac{1}{h} > \frac{1}{\tan(h)} \quad \left[\text{as } 0 < h < \frac{\pi}{2} \right]$$

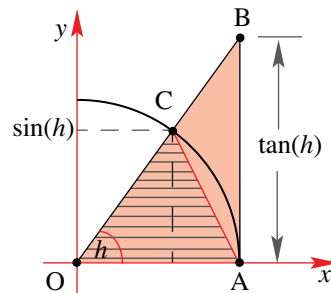

Multiplying through by $\sin(h)$ we have: $\frac{1}{1} > \frac{\sin(h)}{h} > \cos(h)$.

Now, as $h \rightarrow 0$, $\cos(h) \rightarrow 1$ and seeing as $\frac{\sin(h)}{h}$ lies between 1 and $\cos(h)$, then, taking the

limit we have: $\lim_{h \rightarrow 0} 1 > \lim_{h \rightarrow 0} \frac{\sin(h)}{h} > \lim_{h \rightarrow 0} \cos(h) \Leftrightarrow 1 > \lim_{h \rightarrow 0} \frac{\sin(h)}{h} > 1 \Rightarrow \lim_{h \rightarrow 0} \frac{\sin(h)}{h} = 1$.

Note: As the function $f(h) = \frac{\sin h}{h}$ is an even function, $f(h) = f(-h)$, it is only necessary to prove our result for the case where h was positive. The proof is complete because, as $f(h) = f(-h)$, then the result would hold true for h being negative.

What if x was in degrees?

We would need to convert from degrees to radians: i.e., $x^\circ = \frac{\pi}{180}x^\circ$.

$$\text{So, } \frac{d}{dx}(\sin x^\circ) = \frac{d}{dx}\left(\sin \frac{\pi}{180}x\right) = \frac{\pi}{180} \cos\left(\frac{\pi}{180}x\right) = \frac{\pi}{180} \cos(x^\circ).$$

Notice that $\frac{d}{dx}(\sin x^\circ) \neq \cos(x^\circ)$

The tangent function

For this proof we use the ratio definition of the tangent, i.e., $\tan \theta = \frac{\sin \theta}{\cos \theta}$, $\cos \theta \neq 0$ and then make use of the quotient rule.

$$\begin{aligned} \text{So, letting } f(\theta) = \tan \theta = \frac{\sin \theta}{\cos \theta} \text{ we have } f'(\theta) &= \frac{\frac{d}{d\theta}(\sin \theta) \times \cos \theta - \sin \theta \times \frac{d}{d\theta}(\cos \theta)}{(\cos \theta)^2} \\ &= \frac{\cos \theta \times \cos \theta - \sin \theta \times (-\sin \theta)}{\cos^2 \theta} \\ &= \frac{\cos^2 \theta + \sin^2 \theta}{\cos^2 \theta} \\ &= \frac{1}{\cos^2 \theta} \\ &= \sec^2 \theta \end{aligned}$$

Again, a more formal proof can be obtained by using a first principle approach: i.e., using the definition $f'(\theta) = \lim_{h \rightarrow 0} \frac{\tan(\theta + h) - \tan \theta}{h}$.

$$\begin{aligned} \text{Now, } \tan(\theta + h) - \tan \theta &= \frac{\sin(\theta + h)}{\cos(\theta + h)} - \frac{\sin \theta}{\cos \theta} = \frac{\sin(\theta + h)\cos \theta - \sin \theta \cos(\theta + h)}{\cos \theta \cos(\theta + h)} \\ &= \frac{\sin[(\theta + h) - \theta]}{\cos \theta \cos(\theta + h)} \\ &= \frac{\sin h}{\cos \theta \cos(\theta + h)} \end{aligned}$$

$$\begin{aligned} \therefore f'(\theta) &= \lim_{h \rightarrow 0} \frac{1}{h} \times \frac{\sinh}{\cos \theta \cos(\theta + h)} = \frac{1}{\cos \theta} \left[\lim_{h \rightarrow 0} \frac{\sinh}{h} \cdot \frac{1}{\cos(\theta + h)} \right] = \frac{1}{\cos \theta} \cdot 1 \cdot \frac{1}{\cos \theta} \\ &= \frac{1}{\cos^2 \theta} \end{aligned}$$

That is, if $f(\theta) = \tan \theta$ then $f'(\theta) = \sec^2 \theta$.

19.8.5 EXPONENTIAL AND $y = x^n$ WHERE n IS REAL

The exponential function

This approach makes use of a result that will be looked at by students who study the Series and Differential Equations Option for this course. We only include it as a point of interest and so, suffice to state that a polynomial expression for the exponential function can be obtained. Such an expression is given by

$$e^x = 1 + x + \frac{x^2}{2!} + \frac{x^3}{3!} + \frac{x^4}{4!} + \dots, x \in \mathbb{R}$$

Notice that this **series** continues indefinitely.

Then, using our definition of differentiation we have:

$$f'(x) = \lim_{h \rightarrow 0} \frac{f(x+h) - f(x)}{h} = \lim_{h \rightarrow 0} \frac{e^{x+h} - e^x}{h} = \lim_{h \rightarrow 0} \frac{e^x \cdot e^h - e^x}{h} = e^x \lim_{h \rightarrow 0} \frac{e^h - 1}{h}$$

$$\begin{aligned} \text{Now, } \frac{e^h - 1}{h} &= \frac{1}{h}(e^h - 1) = \frac{1}{h} \left(\left[1 + h + \frac{h^2}{2!} + \frac{h^3}{3!} + \frac{h^4}{4!} + \dots \right] - 1 \right) = \frac{1}{h} \left(h + \frac{h^2}{2!} + \frac{h^3}{3!} + \frac{h^4}{4!} + \dots \right) \\ &= 1 + \frac{h}{2!} + \frac{h^2}{3!} + \frac{h^3}{4!} + \dots \end{aligned}$$

$$\text{Then, } \lim_{h \rightarrow 0} \frac{e^h - 1}{h} = \lim_{h \rightarrow 0} \left(1 + \frac{h}{2!} + \frac{h^2}{3!} + \frac{h^3}{4!} + \dots \right) = 1$$

$$\text{And so, } f'(x) = e^x \lim_{h \rightarrow 0} \frac{e^h - 1}{h} = e^x \times 1 = e^x$$

The debate as to whether this is an actual proof or not can be argued both ways, however, it does provide us with another avenue of showing how a result can be confirmed via different and appropriate means.

The power function, $y = x^n$ where n is real

$$\begin{aligned} \text{Let } y = x^n \text{ then } y &= e^{\ln x^n} = e^{n \ln x}, x > 0. \text{ Therefore, } \frac{dy}{dx} = \left(n \cdot \frac{1}{x} \right) \cdot e^{n \ln x} = \frac{n}{x} \cdot x^n \\ &= n x^{n-1} \end{aligned}$$

A rather short and neat proof!

20.1 TANGENTS AND NORMALS

20.1.1 EQUATION OF TANGENT

The gradient of a curve $y = f(x)$ at any point (x_1, y_1) is equal to the gradient of the tangent to the curve at that point. To find the gradient at (x_1, y_1) , you need to

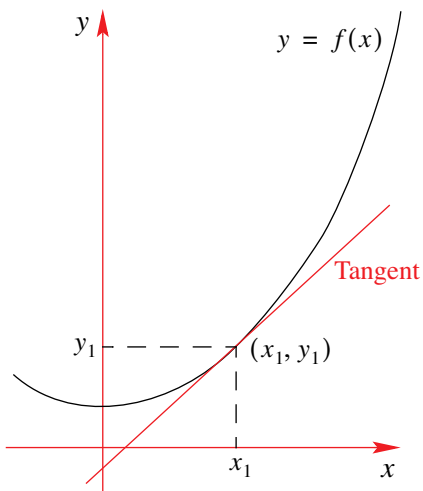

1. Find the gradient function of $y = f(x)$, that is, find the derivative $\frac{dy}{dx} = f'(x)$.
2. Find the gradient at (x_1, y_1) , that is, find $f'(x_1)$.

This gives the gradient of the tangent, m , at the point (x_1, y_1) .

Finally, to find the **equation of the tangent**, you need to use the straight line equation

$$y - y_1 = m(x - x_1), \text{ where } m = f'(x_1)$$

EXAMPLE 20.1

Find the equation of the tangent to the curve $y = 5 - x^2$ at the point $(1, 4)$.

S
o
i
l
u
t
i
o
n

1. Given that $y = 5 - x^2 \Rightarrow \frac{dy}{dx} = -2x$.
2. Then, for $x = 1$, we have $\frac{dy}{dx} = -2(1) = -2$.

Therefore, using $y - y_1 = m(x - x_1)$, with $m = -2$ and $(x_1, y_1) \equiv (1, 4)$, we have the equation of the tangent given by

$$y - 4 = (-2)(x - 1) \Leftrightarrow y - 4 = -2x + 2$$

That is, $y = -2x + 6$

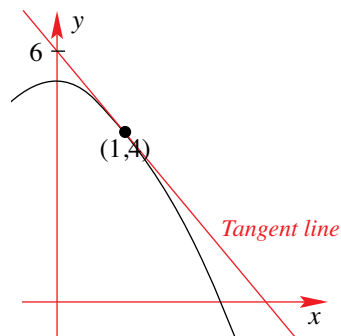

EXAMPLE 20.2

Find the equation of the tangent to the curve $y = x^3 - 8$ where $x = 2$.

S
o
i
l
u
t
i
o
n

Given that $y = x^3 - 8 \Rightarrow y' = 3x^2$. Then, for $x = 2$, $y' = 3 \times 2^2 = 12$. i.e., $m = 12$.

In order to use the equation $y - y_1 = m(x - x_1)$ we need both x - and y -values. As we are only

given the x -value, we now determine the corresponding y -value, i.e., $x = 2 \Rightarrow y = 2^3 - 8 = 0$.

With $(x_1, y_1) \equiv (2, 0)$ the equation of the tangent is: $(y - 0) = 12(x - 2) \Leftrightarrow y = 12x - 24$.

EXAMPLE 20.3

For the curve $x \mapsto 3x^2e^{-0.2x}$, find the equation of the tangent at the point $(1, 3e^{-0.2})$.

Solution

Let $f(x) = 3x^2e^{-0.2x} \therefore f'(x) = 3\left(\frac{d}{dx}(x^2) \times e^{-0.2x} + x^2 \times \frac{d}{dx}(e^{-0.2x})\right)$ [Using the product rule]
 $= 3(2xe^{-0.2x} - 0.2x^2e^{-0.2x})$

That is, $f'(x) = 3xe^{-0.2x}(2 - 0.2x)$.

Therefore, at $x = 1$, we have

$$f'(1) = 3(1)e^{-0.2}(2 - 0.2) = 5.4e^{-0.2}.$$

Using the general equation for a straight line,

$$y - y_1 = m(x - x_1),$$

where $m = 5.4e^{-0.2}$ and $(x_1, y_1) \equiv (1, 3e^{-0.2})$

we have:

$$y - 3e^{-0.2} = 5.4e^{-0.2}(x - 1)$$

$$\Leftrightarrow y - 3e^{-0.2} = 5.4e^{-0.2}x - 5.4e^{-0.2}$$

giving the equation of the tangent at $(1, 3e^{-0.2})$ as $y = 5.4e^{-0.2}x - 2.4e^{-0.2}$.

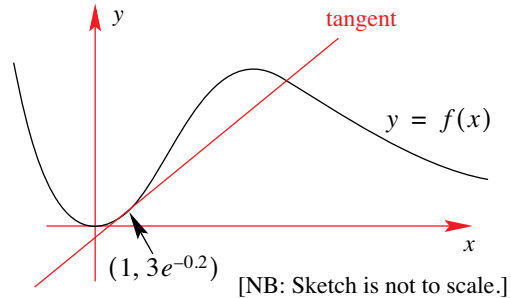

EXAMPLE 20.4

Find the equation of the tangent to the curve defined by $x^2y - y = x^2 - 4$ at the point where it crosses the positive x -axis.

Solution

We first determine the gradient function.

Differentiating both sides of the equation with respect to x we have:

$$\frac{d}{dx}(x^2y - y) = \frac{d}{dx}(x^2 - 4) \Rightarrow 2xy + x^2 \cdot \frac{dy}{dx} - \frac{dy}{dx} = 2x$$

$$\therefore (x^2 - 1) \cdot \frac{dy}{dx} = 2x - 2xy$$

$$\Leftrightarrow \frac{dy}{dx} = \frac{2x(1 - y)}{(x^2 - 1)}$$

At the point where the curve crosses the x -axis we have that $y = 0$, so, substituting $y = 0$ into the equation of the curve we have: $x^2(0) - (0) = x^2 - 4 \Leftrightarrow 0 = x^2 - 4 \Leftrightarrow x = \pm 2$.

As we are only interested in the positive x -axis, we choose $x = 2$.

So, the gradient of the curve at the point $(2, 0)$ is given by $\frac{dy}{dx} = \frac{2 \times 2(1 - 0)}{2^2 - 1} = \frac{4}{3}$.

Using the equation of the straight line, $y - y_1 = m(x - x_1)$ with $m = \frac{4}{3}$ and $(x_1, y_1) \equiv (2, 0)$

we have the equation of the tangent given by $y - 0 = \frac{4}{3}(x - 2) \Leftrightarrow 3y - 4x + 8 = 0$.

NB: We could have first expressed y explicitly in terms of x . i.e., $x^2y - y = x^2 - 4 \Leftrightarrow y = \frac{x^2 - 4}{x^2 - 1}$

20.1.2 EQUATION OF NORMAL

To find the equation of the normal at the point (x_1, y_1) we first need to determine the gradient of the tangent, m_t , and then use the relationship between the gradients of two perpendicular lines (given that the normal is perpendicular to the tangent).

To find the equation of the normal we need to

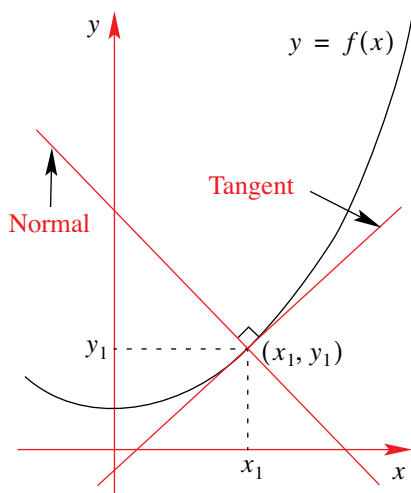

1. Find the gradient function of $y = f(x)$, that is, find the derivative $\frac{dy}{dx} = f'(x)$.
2. Find the gradient at (x_1, y_1) , that is, find $f'(x_1)$.

This gives the gradient of the tangent, $m_t = f'(x_1)$, at the point (x_1, y_1) .

3. To find the gradient of the normal, m_N , we use the fact that the product of the gradients of two perpendicular lines is -1 .

i.e., $m_t \times m_N = -1$ (or $m_N = -\frac{1}{m_t}$)

Finally, to find the **equation of the normal**, we need to use the general equation for a straight line $y - y_1 = m(x - x_1)$, where this time $m = m_N = -\frac{1}{m_t} = -\frac{1}{f'(x_1)}$.

EXAMPLE 20.5

Find the equation of the normal to the curve $y = 2x^3 - x^2 + 1$ at the point $(1, 2)$.

S
o
l
u
t
i
o
n

First determine the gradient of the tangent: $\frac{dy}{dx} = 6x^2 - 2x$.

At $x = 1$, we have $\frac{dy}{dx} = 6(1)^2 - 2(1) = 4$. That is, $m_t = 4$.

We can now determine the gradient of the normal: using $m_N = -\frac{1}{m_t}$ we have $m_N = -\frac{1}{4}$.

Using the equation of a straight line, $y - y_1 = m(x - x_1)$ where $(x_1, y_1) \equiv (1, 2)$ and $m = -\frac{1}{4}$

we have that $y - 2 = -\frac{1}{4}(x - 1) \Leftrightarrow 4y - 8 = -x + 1$

Hence the equation of the normal is given by $4y + x = 9$.

EXAMPLE 20.6

Determine the equation of the normal to the curve $y = xe^{-2x} + 2$ at the point where the curve crosses the y -axis.

Solution

We first need to determine the y -intercept: $x = 0 \Rightarrow y = 0 \times e^0 + 2 = 2$.

That is, the curve passes through the point $(0, 2)$.

Next, we need to determine the gradient of the tangent where $x = 0$.

$$\begin{aligned} \text{From } y = xe^{-2x} + 2 \Rightarrow \frac{dy}{dx} &= 1 \times e^{-2x} + x(-2e^{-2x}) \quad [\text{Using the product rule}] \\ &= e^{-2x} - 2xe^{-2x} \end{aligned}$$

$$\text{Therefore, at } x = 0, \quad \frac{dy}{dx} = e^{-2(0)} - 2(0)e^{-2(0)} = 1 - 0 = 1.$$

That is, $m_t = 1 \Rightarrow m_N = -\frac{1}{1} = -1$. Then, using the general equation of a straight line we have the equation of the normal as $y - 2 = -1(x - 0)$, or $y = -x + 2$.

EXAMPLE 20.7

Find the equation of the normal to the curve $f(x) = \sqrt{x+2}$ at the point where $y = 3$.

Solution

This time, we need to first determine the x -value when $y = 3$:

$$3 = \sqrt{x+2} \Rightarrow 9 = x+2 \Leftrightarrow x = 7$$

Therefore, we want the equation of the normal at the point $(7, 3)$.

$$\text{Now, } f(x) = \sqrt{x+2} = (x+2)^{1/2} \Rightarrow f'(x) = \frac{1}{2}(x+2)^{-1/2}$$

$$\text{Next, } f'(7) = \frac{1}{2\sqrt{7+2}} = \frac{1}{6} (= m_t). \text{ Therefore } m_N = -6 (= \text{gradient of normal}).$$

The equation of the normal is given by $y - 3 = -6(x - 7)$ or $y + 6x = 45$.

EXAMPLE 20.8

Find the equation of the normal to the curve whose equation is given by $x^2 + 2y - 2 = e^y$ at the point where $y = 0$ and $x > 0$.

Solution

We first need to find the gradient where $y = 0$, i.e., we need to find $\frac{dy}{dx}$.

$$\text{Diff b.s.w.r.t. } x: \quad \frac{d}{dx}(x^2 + 2y - 2) = \frac{d}{dx}(e^y) \Leftrightarrow 2x + 2\frac{dy}{dx} = \left[\frac{d}{dy}(e^y) \right] \cdot \frac{dy}{dx}$$

$$\Leftrightarrow 2x = (e^y - 2)\frac{dy}{dx}$$

$$\Leftrightarrow \frac{dy}{dx} = \frac{2x}{(e^y - 2)}$$

Next, substituting $y = 0$ into the equation $x^2 + 2y - 2 = e^y$, we get $x^2 + 2(0) - 2 = e^0$ so that

$$x^2 - 2 = 1 \Leftrightarrow x^2 - 3 = 0 \Leftrightarrow x = \pm\sqrt{3}. \text{ Then, as } x > 0 \Rightarrow x = \sqrt{3}.$$

$$\text{We can now determine the gradient of the tangent: } \frac{dy}{dx} = \frac{2\sqrt{3}}{(e^0 - 2)} = -2\sqrt{3} (= m_t).$$

$$\text{So the gradient of the normal is given by } m_N = -\frac{1}{m_t} = -\left(\frac{1}{-2\sqrt{3}}\right) = \frac{1}{2\sqrt{3}}.$$

$$\text{Using the equation for a straight line, } y - y_1 = m(x - x_1), \text{ with } (x_1, y_1) \equiv (\sqrt{3}, 0), m = \frac{1}{2\sqrt{3}}$$

$$\text{we have the equation of the normal as } y - 0 = \frac{1}{2\sqrt{3}}(x - \sqrt{3}) \Leftrightarrow 2\sqrt{3}y - x + \sqrt{3} = 0.$$

EXERCISES 20.1

1. Find the equations of the tangents to the following curves at the points indicated

(a) $y = x^3 - x^2 - x + 2$ at $(2, 4)$

(b) $y = x^4 - 4x^2 + 3$ at $(1, 0)$

(c) $y = \sqrt{x+1}$ at $(3, 2)$

(d) $y = \frac{1}{\sqrt{x-1}} + \frac{1}{2}$ at $(5, 1)$

(e) $f(x) = \frac{x}{x+1}, x \neq -1$ at $\left(1, \frac{1}{2}\right)$

(f) $f(x) = \frac{2x}{x+2}, x \neq -2$ at $(2, 1)$

(g) $x \mapsto x(x^3 - 4)$ at $(2, 8)$

(h) $x \mapsto \frac{x^2}{x-1}, x \neq 1$ at $(2, 4)$

2. Find the equation of the normal for each of the curves in Question 1.

3. Find the equations of the tangents to the following curves at the points indicated

(a) $y = xe^x$ at $(1, e)$

(b) $x \mapsto \frac{e^x}{x}, x \neq 0$ at $(1, e)$

(c) $f(x) = x + \sin(x)$ at (π, π)

(d) $y = x \cos(x)$ at $(\pi, -\pi)$

(e) $y = \frac{x}{\sin(x)}$ at $\left(\frac{\pi}{2}, \frac{\pi}{2}\right)$

(f) $x \mapsto x \log_e(x+1)$ at $(e-1, e-1)$

(g) $x \mapsto xe^{x^2+1}$ at $(0, 0)$

(h) $f(x) = \sin(2x) + \cos(x)$ at $(0, 1)$

4. Find the equation of the normal for each of the curves in Question 3.

5. Find the equation of the tangent to the curve $y = x^2(x^2 - 1)$ at the point A(2, 12). The tangent at a second point, B(-2, 12), intersects the tangent at A at the point C. Determine the type of triangle enclosed by the points A, B and C.

Show that the tangents drawn at the points X and Y, where $x = a$ and $x = -a$ respectively will always meet at a third point Z which will lie on the y-axis.

MATHEMATICS – Higher Level (Core)

- 6.** Find the equation of the tangent and the normal to the curve $x \mapsto x + \frac{1}{x}$, $x \neq 0$ at the point $(1, 2)$. Find the coordinates of the points where the tangent and the normal cross the x - and y -axes, and hence determine the area enclosed by the x -axis, the y -axis, the tangent and the normal.
- 7.** Find the equation of the normal to the curve $y = \sqrt{25 - x^2}$ at the point $(4, 3)$.
- 8.** Show that every normal to the curve $y = \sqrt{a^2 - x^2}$ will always pass through the point $(0,0)$.
- 9.** Find the equation of the tangent to the curve $y = x^2 - 2x$ that is parallel to the line with equation $y = 4x + 2$.
- 10.** Find the equation of the tangent to the curve $x \mapsto \log_e(x^2 + 4)$ at the point where the curve crosses the y -axis.
- 11.** Find the equation of the tangent and the normal to the curve $x \mapsto x \tan(x)$ where $x = \frac{\pi}{4}$.
- 12.** The straight line $y = -x + 4$ cuts the parabola with equation $y = 16 - x^2$ at the points A and B.
 (a) Find the coordinates of A and B.
 (b) Find the equation of the tangents at A and B, and hence determine where the two tangents meet.
- 13.** For the curve defined by $x \mapsto \frac{x}{x^2 + 1}$ find the equation of the normal at the origin, and the equations of the tangents that are parallel to the x -axis. Find also the points where the tangents and the normal intersect.

- 14.** The figure shows the curve whose equation is given by

$$y^2 = (x - 1)^3.$$

The tangent drawn at the point $P(5,8)$ meets the curve again at the point Q .

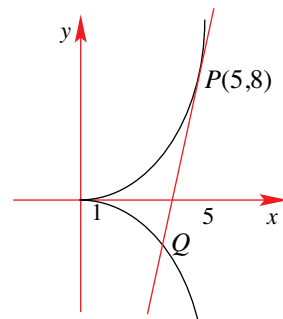

- (a) Find the equation of the tangent at the point P .
 (b) Find the coordinates of Q .

- 15.** The line L and the curve C are defined as follows,

$$L: y = 4x - 2 \text{ and } C: y = mx^3 + nx^2 - 1$$

The line L is a tangent to the curve C at $x = 1$.

- (a) Using the fact that L and C meet at $x = 1$, show that $m + n = 3$.
 (b) Given that L is a tangent to C at $x = 1$, show that $3m + 2n = 4$.
 (c) Hence, solve for m and n .

16. For each of the following curves, find the equation of the normal at the points indicated.

- (a) $x^2 + 2y^2 = 9$ at the point $(1, 2)$
 (b) $2xy - \sqrt{x^2 + y^2} = 19$ at the point $(3, 4)$
 (c) $4(x + y) + 3xy = 0$ at the point $(-1, 4)$
 (d) $x = \tan\left(\frac{x}{y}\right)$ at the point $\left(1, \frac{4}{\pi}\right)$
 (e) $x^2 + 3xy^2 - 4 = 0$ at the point $(1, 1)$.

17. For the curve $x^2 + y^2 - xy = 3$, find

- (a) the equation of the normal at $(2, 1)$.
 (b) the equations of the tangents to the curve that are parallel to the x -axis.

18. Find the equation of the lines l_1 and l_2 in each of the following situations.

- (a) $x^2 - y^3 = 0$ (b) $x - y^2 = 1$ (c) $4y^2 - x^2 = 32$

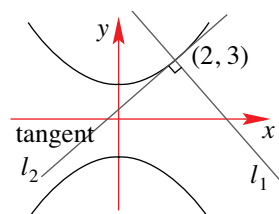
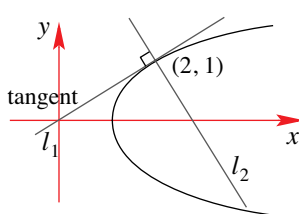
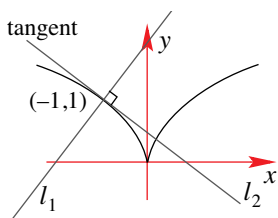

19. Find the point of intersection of the tangents to the curve $y^2 - 3xy + x^3 = 3$ at the points where $x = -1$.

20.2 CURVE SKETCHING

20.2.1 INCREASING AND DECREASING FUNCTIONS

A function f is said to be **increasing** if its **graph rises** as it is sketched from left to right.

That is, if $x_2 > x_1 \Rightarrow f(x_2) > f(x_1)$

(i.e., the y -values increase as the x -values increase).

Similarly,

A function f is said to be **decreasing** if its **graph falls** as it is sketched from left to right.

That is, if $x_2 > x_1 \Rightarrow f(x_2) < f(x_1)$

(i.e., the y -values decrease as the x -values increase).

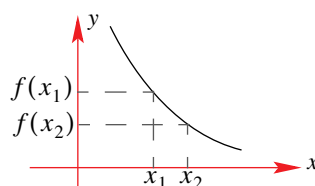
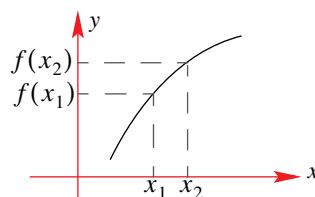

... A calculus point of view

The derivative can be used to determine whether a function is increasing or decreasing and so it can be used to help find those values of x for which the function is increasing or decreasing.

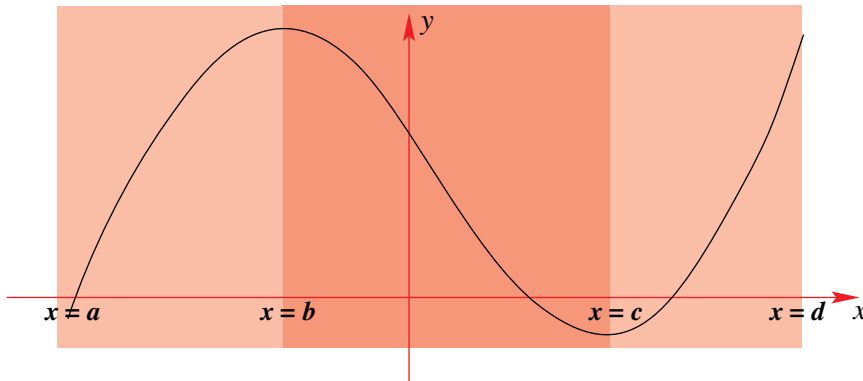

Any tangent line drawn in the interval $a < x < b$ will always have a positive gradient. This

means that $\frac{dy}{dx} = f'(x) > 0$ in this region.

Any tangent line drawn in the interval $b < x < c$ will always have a negative gradient. This

means that $\frac{dy}{dx} = f'(x) < 0$ in this region.

Any tangent line drawn in the interval $c < x < d$ will always have a positive gradient. This

means that $\frac{dy}{dx} = f'(x) > 0$ in this region.

This means that to determine where a function is increasing or decreasing, the values of x for which $f'(x) > 0$ and $f'(x) < 0$ respectively need to be found.

EXAMPLE 20.9

Find the values of x for which the function $f(x) = 1 + 4x - x^2$ is increasing.

S
O
L
V
E
D
I
N

By definition, a function is increasing for those values of x for which $f'(x) > 0$.

Therefore: 1. find $f'(x)$

2. find the values of x such that $f'(x) > 0$

Now, $f(x) = 1 + 4x - x^2 \Rightarrow f'(x) = 4 - 2x$

Then, $f'(x) > 0 \Leftrightarrow 4 - 2x > 0$

$$\Leftrightarrow 4 > 2x$$

$$\Leftrightarrow x < 2$$

We could also have determined this by sketching the graph of $f(x) = 1 + 4x - x^2$. The turning point can be determined by completing the square. i.e., $f(x) = -(x - 2)^2 + 5$ giving the axis of symmetry as $x = 2$.

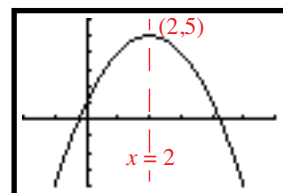

EXAMPLE 20.10

Find the values of x for which the function $f(x) = x \log_e x, x > 0$ is increasing.

Solution

Unless you already know what this function looks like, it is difficult to determine the interval for which the function is increasing without using calculus.

First we differentiate (using the product rule): $f'(x) = 1 \times \log_e x + x \times \frac{1}{x} = \log_e x + 1$

Now, $f(x)$ is increasing for values of x for which $f'(x) > 0$.

$f(x) = x \log_e x, x > 0 :$

Therefore we need to solve $\log_e x + 1 > 0$.

Now, $\log_e x + 1 > 0 \Leftrightarrow \log_e x > -1$

$\Leftrightarrow x > e^{-1}$

(The inequality can be determined by making use of a sketch of $f(x) = x \log_e x, x > 0$.)

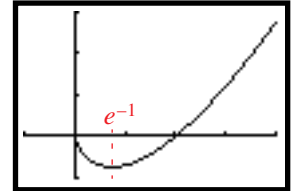

That is, $f(x) = x \log_e x, x > 0$ increases for values of x such that $x > e^{-1}$.

$f'(x) = \log_e x + 1 :$

Note that we could have used the graph of the derivative function, $y = f'(x)$, and from it, determined those values of x for which the graph is above the x -axis.

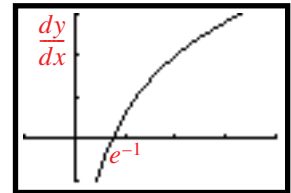

20.2.2 STATIONARY POINTS

So far we have discussed the conditions for a function to be increasing ($f'(x) > 0$) and for a function to be decreasing ($f'(x) < 0$). What happens at the point where a function changes from an increasing state ($f'(x) > 0$) to $f'(x) = 0$ and then to a decreasing state ($f'(x) < 0$) or vice-versa?

Points where this happens are known as **stationary points**. At the point where the function is in a state where it is neither increasing nor decreasing, we have that $f'(x) = 0$. There are times when we can call these stationary points stationary points, but on such occasions, we prefer the terms **local maximum** and **local minimum** points.

At the point(s) where $\frac{dy}{dx} = f'(x) = 0$

we have a **stationary point**.

There are three types of stationary points, namely; **local maximum** point, **local minimum** point and **stationary point of inflection**.

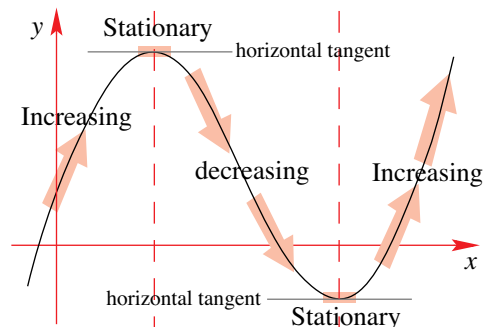

1. Local Maximum

When sketching a curve, if the following properties hold:

- i. At $P(x_1, y_1)$, $\frac{dy}{dx} = f'(x) = 0$ that is $f'(x_1) = 0$.
- ii. For $x < x_1$ then $\frac{dy}{dx} > 0$
 $x > x_1$ then $\frac{dy}{dx} < 0$

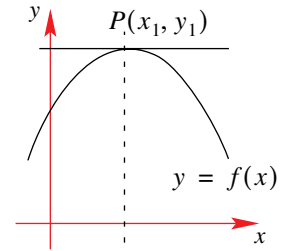

where the two chosen values of x are such that one is just slightly less than x_1 and the other is just slightly greater than x_1 . Then,

$y = f(x)$ has a local maximum point (also known as a **relative maximum**) at the point $P(x_1, y_1)$.

iv. Graph of the gradient function:

Notice that the values of $\frac{dy}{dx}$ are changing from

positive to **negative**. Sometimes this is referred to as the sign of the first derivative.

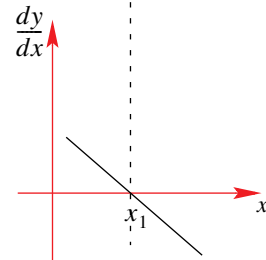

At this stage, it isn't so much the magnitude of the derivative that is important, but that there is a **change in the sign of the derivative** near $x = x_1$.

In this instance the sign of the derivative changes from positive to negative.

This change in sign is sometimes represented via the diagram alongside, which is referred to as a **sign diagram of the first derivative**. Such diagrams are used to confirm the nature of stationary points (in this case, that a local maximum occurs at $x = x_1$).

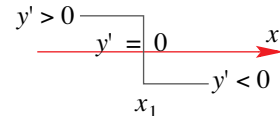

EXAMPLE 20.11

Find the local maximum value of the function whose equation is

$$f(x) = -3 + 4x - x^2.$$

S
o
l
u
t
i
o
n

First we differentiate: $f(x) = -3 + 4x - x^2 \Rightarrow f'(x) = 4 - 2x$

Next, equate $f'(x)$ to 0 and solve for x : $0 = 4 - 2x$

$$\Leftrightarrow x = 2$$

To ensure that we have obtained a local maximum we choose values of x slightly less than 2 and slightly greater than 2, for example, choose $x = 1.9$ and $x = 2.1$.

For $x = 1.9$, we have that $f'(1.9) = 4 - 2(1.9) = 0.2$.

For $x = 2.1$ we have that $f'(2.1) = 4 - 2(2.1) = -0.2$.

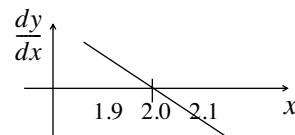

Using the graph of the gradient function, $\frac{dy}{dx}$, confirms that there is a local maximum at $x = 2.0$.

The local maximum value of $f(x)$, is found by substituting $x = 2$ into the given equation:

$$f(2) = -3 + 4(2) - (2)^2 = 1. \text{ That is, the local maximum occurs at the point } (2,1).$$

This process can also be carried out using the TI-83:

1. Enter equation
2. Use the **CALC** function, and then select **4:maximum**
3. Press **ENTER**. This will prompt you to choose a lower (left) bound then an upper (right) bound and finally to make a guess
4. Press **ENTER** once more. This will provide both x - and y - values of the stationary point.

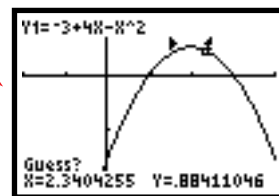
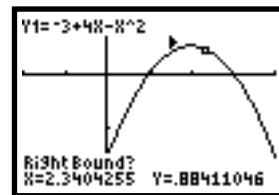
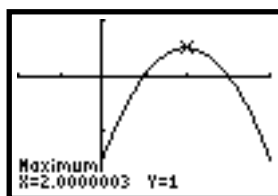
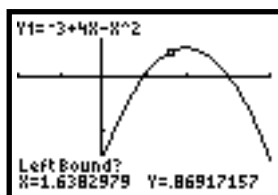
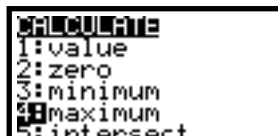
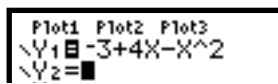

Move the cursor to a point between the two arrows and press **ENTER**.

The other option is to use the **fMax** command from the **MATH** screen. However, this will require some idea of the left and right bounds (which can be estimated from the graph of the function). We illustrate this in the next example.

EXAMPLE 20.12

Determine the coordinates of the local maximum for the function

$$f(x) = x^2 \sin(x), -1 \leq x \leq 4$$

S
O
L
U
T
I
O
N

This time we start by sketching a graph of the function, setting the **WINDOW** parameters with the appropriate values (i.e., $-1 \leq x \leq 4$):

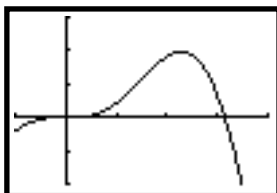
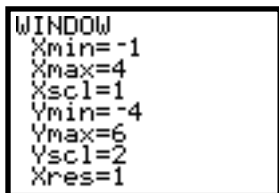

We can now use the **fMax** command from the **MATH** screen to determine the x -ordinate of the stationary point and then use the **CALC** function to find the y -ordinate:

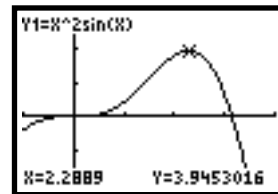
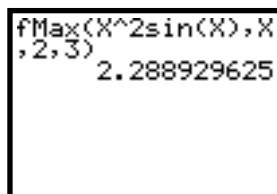

MATHEMATICS – Higher Level (Core)

Therefore, the coordinates to 2 d.p are given by (2.29, 3.95).

Had we used an algebraic approach to this question, we would have had to solve for

$$f'(x) = 0 \text{ i.e., } 2x\sin(x) + x^2\cos(x) = 0 \Leftrightarrow x[2\sin(x) + x\cos(x)] = 0$$

$$\Leftrightarrow x = 0 \text{ or } 2\sin(x) + x\cos(x) = 0$$

For which, other than $x = 0$, no exact solution exist.

2. Local Minimum

When sketching a curve, if the following properties hold:

i. At $P(x_1, y_1)$, $\frac{dy}{dx} = f'(x) = 0$ that is $f'(x_1) = 0$.

ii. For $x > x_1$ then $\frac{dy}{dx} > 0$

$x < x_1$ then $\frac{dy}{dx} < 0$

where the two chosen values of x are such that one is just slightly greater than x_1 and the other is just slightly less than x_1 . Then,

$y = f(x)$ has a local minimum point (also known as a **relative minimum**) at the point $P(x_1, y_1)$.

iv. Graph of the gradient function:

Notice that the values of $\frac{dy}{dx}$ are changing from

negative to **positive**. Sometimes this is referred to as the sign of the first derivative.

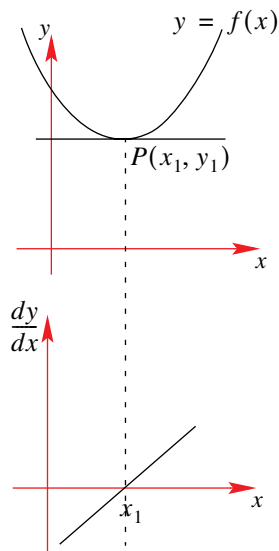

Again we can represent the change in the sign of the first derivative via the diagram alongside, which is referred to as a **sign diagram of the first derivative**. Such diagrams are used to confirm the nature of stationary points (in this case, that a local minimum occurs at $x = x_1$).

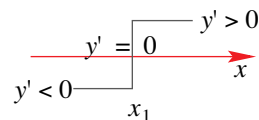

EXAMPLE 20.13

Find the minimum value of $x \mapsto \frac{e^x}{x}, x > 0$.

Solution First differentiate (using the quotient rule):

$$\frac{d}{dx}\left(\frac{e^x}{x}\right) = \frac{\frac{d}{dx}(e^x) \times x - e^x \times \frac{d}{dx}(x)}{x^2} = \frac{e^x x - e^x}{x^2} = \frac{e^x(x-1)}{x^2}$$

We solve for $\frac{d}{dx}\left(\frac{e^x}{x}\right) = 0$, i.e., $\frac{e^x(x-1)}{x^2} = 0 \Leftrightarrow e^x(x-1) = 0$

S
o
l
u
t
i
o
n

However, $e^x \neq 0$ for all real values of x , therefore, the only possible solution occurs if $x = 1$.

To verify that we have a local minimum we select a value of x slightly less than $x = 1$ and one slightly greater than $x = 1$:

For ($x < 1$): choose $x = 0.9$, we have that $\frac{d}{dx}\left(\frac{e^x}{x}\right) = -0.30$.

For ($x > 1$): choose $x = 1.1$, we have that $\frac{d}{dx}\left(\frac{e^x}{x}\right) = 0.25$.

Therefore, for $x = 1$ we have a local minimum point.

The minimum value is therefore given by $y = \frac{e^1}{1} = e$, and occurs at the point $(1, e)$.

Sign diagram of first derivative:

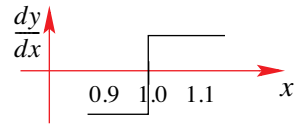

Graph of function:

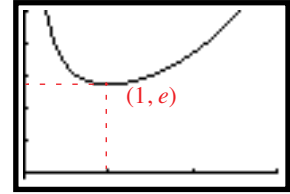

EXAMPLE 20.14

Find the local minimum of the function

$$y = \sin(x) + \frac{1}{2}\sin(2x), 0 \leq x \leq 2\pi.$$

S
o
l
u
t
i
o
n

We start by differentiating and finding the stationary points (i.e., solving for $\frac{dy}{dx} = 0$):

$$\text{Now, } y = \sin(x) + \frac{1}{2}\sin(2x) \Rightarrow \frac{dy}{dx} = \cos(x) + \cos(2x).$$

Therefore, solving we have $\cos(x) + \cos(2x) = 0$

$$\cos(x) + (2\cos^2(x) - 1) = 0$$

$$(2\cos(x) - 1)(\cos(x) + 1) = 0$$

Therefore, $\cos(x) = \frac{1}{2}$ or $\cos(x) = -1$. i.e., $x = \frac{\pi}{3}, \frac{5\pi}{3}$ or $x = \pi$ for $x \in [0, 2\pi]$.

We can check the nature of the stationary points by making use of the sign of the first derivative:

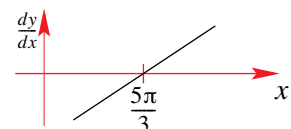
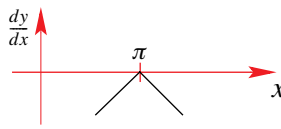
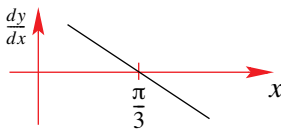

The graph of gradient function (near $x = \frac{5\pi}{3}$) indicates that a local minimum occurs at $x = \frac{5\pi}{3}$.

And so, the local minimum value is given by $y = \sin\left(\frac{5\pi}{3}\right) + \frac{1}{2}\sin\left(\frac{10\pi}{3}\right) = -\frac{3\sqrt{3}}{4}$.

NB: In the process we have come across a new sign diagram (at $x = \pi$). This is dealt with in the next section.

3. Points of Inflection

There are two types:

- A.** Stationary points of inflection
- B.** Non-stationary points of inflection.

A. Stationary point of inflection

The following properties hold at a stationary point of inflection.

- i.** At $P(x_1, y_1)$, $f'(x) = 0$. That is $f'(x_1) = 0$.
- ii.** For $x < x_1$, $f'(x) > 0$ and for $x > x_1$, $f'(x) < 0$.

Similarly,

At $P(x_2, y_2)$, $f'(x) = 0$. That is $f'(x_2) = 0$
and for $x < x_2$, $f'(x) < 0$ and for $x > x_2$, $f'(x) > 0$.

That is, the gradient of the curve on either side of x_1 (or x_2) has the same sign.

- iii.** Graph of the **gradient function**, $y = f'(x)$:
Notice that the values of $f'(x)$ have the same sign on either side of $x = x_1$.

Notice that at $x = x_1$, the gradient of $f'(x)$ is also equal to zero. That is, the derivative of the derivative is equal to zero.

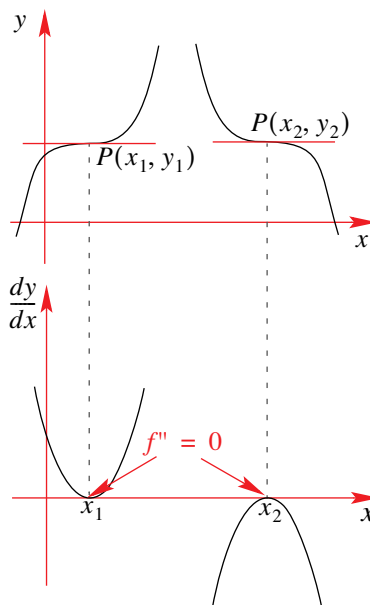

Therefore **if there is a** stationary point of inflection at $x = x_1$ then $f'''(x_1) = 0$.

EXAMPLE 20.15

Find the stationary point of inflection for the graph with equation

$$y = (x - 1)^3(x + 2).$$

Solution

First we differentiate (using the product rule):

$$\begin{aligned} \text{Given } y &= (x - 1)^3(x + 2) \Rightarrow \frac{dy}{dx} = 3(x - 1)^2(x + 2) + (x - 1)^3(1) \\ &= (x - 1)^2[3(x + 2) + (x - 1)] \\ &= (x - 1)^2(4x + 5) \end{aligned}$$

Solving for $\frac{dy}{dx} = 0$, we have, $(x - 1)^2(4x + 5) = 0 \Leftrightarrow x = 1$ or $x = -\frac{5}{4} (= -1.25)$.

We can now check the sign of the derivative on either side of $x = 1$ and $x = -1.25$

At $x = 1$:

$$\text{For } x = 0.9, \frac{dy}{dx} = (-0.1)^2(8.6) = 0.086 > 0$$

$$\text{For } x = 1.1, \frac{dy}{dx} = (0.1)^2(9.4) = 0.094 > 0.$$

As the sign of the first derivative is the same on either side of $x = 1$, we have a stationary point of inflection at $x = 1$. i.e., at $(1, 0)$.

A sketch of the graph of $y = (x - 1)^3(x + 2)$ quickly confirms our result.

For $x = -1.25$, the graph shows a local minimum occurring at this point.

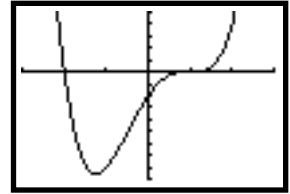

EXAMPLE 20.16

Locate the stationary points of inflection for the curve $f(x) = x^3e^{-x}$.

Solution

We begin by determining where stationary points occur:

$$f(x) = x^3e^{-x} \Rightarrow f'(x) = 3x^2e^{-x} - x^3e^{-x}$$

$$\text{Setting } f'(x) = 0, \text{ we have } 3x^2e^{-x} - x^3e^{-x} = 0 \Leftrightarrow x^2e^{-x}(3 - x) = 0$$

$$\Leftrightarrow x = 0 \text{ or } x = 3$$

We can use the sign of the first derivative to help us determine the nature of the stationary point.

At $x = 3$:

$$\text{For } x = 2.9, f'(2.9) = (2.9)^2e^{-2.9}(3 - 2.9) = 0.046 > 0$$

$$\text{For } x = 3.1, f'(3.1) = (3.1)^2e^{-3.1}(3 - 3.1) = -0.043 < 0$$

Therefore there exists a local maximum at $x = 3.1$.

At $x = 0$:

$$\text{For } x = 0.1, f'(0.1) = (0.1)^2e^{-0.1}(3 - 0.1) = 0.026 > 0$$

$$\text{For } x = -0.1, f'(-0.1) = (-0.1)^2e^{0.1}(3 + 0.1) = 0.034 > 0$$

As there is no change in the sign of the first derivative there is a stationary point of inflection at $x = 0$.

Alternatively, we could sketch a graph of the function and use it to help us determine where the stationary point of inflection occurs:

From the graph we can see that there is a local maximum at $x = 3$ and a stationary point of inflection at $x = 0$.

Therefore, the stationary point of inflection occurs at $(0, 0)$.

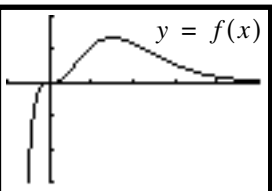

Sign diagram:

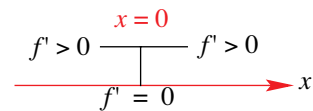
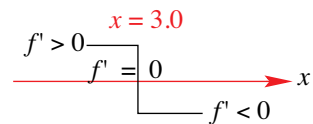

Notice that the sign diagrams of the first derivative in Examples 20.13, 20.14 and 20.16 all look slightly different. We have done this to emphasise that as long as the diagram provides a clear indication of the sign of the first derivative then its appearance can vary.

B. Non-stationary point of inflection

The following properties hold at a non-stationary point of inflection:

- i. At $P(x_1, y_1)$, $f'(x_1) \neq 0$ and $f''(x_1) = 0$.
- ii. For $x < x_1$, $f'(x) > 0$ and for $x > x_1$, $f'(x) > 0$

Similarly,

- At $P(x_2, y_2)$, $f'(x_2) \neq 0$ and $f''(x_2) = 0$.
- For $x < x_2$, $f'(x) < 0$ and for $x > x_2$, $f'(x) < 0$.

That is, the gradient of the curve on either side of x_1 (or x_2) has the same sign.

- iii. Graph of the **gradient function**, $y = f'(x)$:
Notice that the values of $f'(x)$ have the same sign on either side of $x = x_1$.

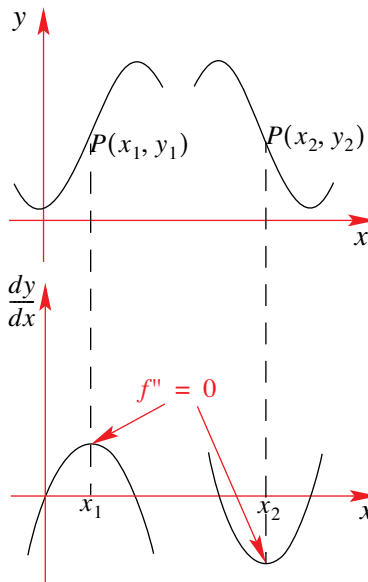

EXAMPLE 20.17

Show that the curve with equation $y = x^4 - 4x^3$ has a non-stationary point of inflection at $x = 2$.

Solution

For the curve to have a non-stationary point of inflection at $x = 2$ we need to show that:

- 1. $\frac{d^2y}{dx^2} = 0$ at $x = 2$ **and**
- 2. the sign of the gradient, $\frac{dy}{dx}$, is the same on both sides of $x = 2$ **and**
- 3. that $\frac{dy}{dx} \neq 0$ when $x = 2$.

A quick sketch of the function indicates that a point of inflection occurs at $x = 2$:

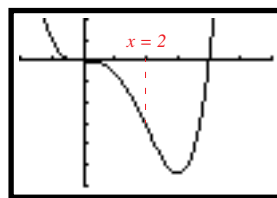

Now, $\frac{dy}{dx} = 4x^3 - 12x^2 \Rightarrow \frac{d^2y}{dx^2} = 12x^2 - 24x$.

For $x = 2$, $\frac{d^2y}{dx^2} = 12(2)^2 - 24(2) = 0$ and $\frac{dy}{dx} = -16 \neq 0$.

For $x = 2.1$, $\frac{dy}{dx} = -15.876$ and for $x = 1.9$, $\frac{dy}{dx} = -15.88$.

Sign diagram:

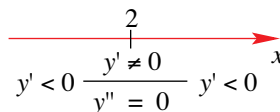

Therefore there is a non-stationary point of inflection at $x = 2$.

It is important to realise that it is **not sufficient** to say that “If $f''(x) = 0$ at $x = a$ then there must be a point of inflection at $x = a$.”

Does $f''(a) = 0$ imply there is a point of inflection at $x = a$?

The answer is **NO!**

Although it is necessary for the second derivative to be zero at a point of inflection, the fact that the second derivative is zero at $x = a$ does **not** mean there must be a point of inflection at $x = a$.

That is:

$f''(a) = 0$ is a necessary but not a sufficient reason for there to be an inflection point at $x = a$.

We use the following example to illustrate this.

Consider the case where $f(x) = x^4$.

Now, $f''(x) = 12x^2$, therefore solving for $f''(x) = 0$,

we have $12x^2 = 0 \Leftrightarrow x = 0$.

That is, $f''(0) = 0$. So, do we have a point of inflection at $x = 0$?

A sketch of f shows that although $f''(x) = 0$ at $x = 0$, there is in fact a local minimum and not a point of inflection at $x = 0$.

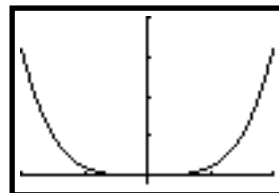

In other words, **finding where $f''(x) = 0$ is not enough** to indicate that there is an inflection point. To determine if there is a point of inflection you need to check the sign of the first derivative on either side of the x -value in question. Or, check the **concavity** at the x -value in question. We will discuss the term concavity in §20.3.

EXAMPLE 20.18

Find and classify all stationary points (and inflection points) of

$$f(x) = x^3 - 3x^2 - 9x + 1.$$

S
o
i
u
t
i
n

Now, $f(x) = x^3 - 3x^2 - 9x + 1 \Rightarrow f'(x) = 3x^2 - 6x - 9$

Solving for stationary points we have, $3x^2 - 6x - 9 = 0 \Leftrightarrow 3(x-3)(x+1) = 0$

$$\Leftrightarrow x = 3 \text{ or } x = -1$$

So that $f(3) = -26$ and $f(-1) = 6$.

Using the sign of the first derivative, we have:

At $x = 3$:

For $x < 3$ ($x = 2.9$) $f'(2.9) < 0$ and

for $x > 3$ ($x = 3.1$) $f'(3.1) > 0$.

Therefore, there is a local minimum at $(3, -26)$.

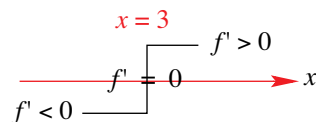

At $x = -1$:

For $x < -1$ ($x = -1.1$) $f'(-1.1) > 0$ and

for $x > -1$ ($x = -0.9$) $f'(-0.9) < 0$.

Therefore, there is a local maximum at $(-1, 6)$.

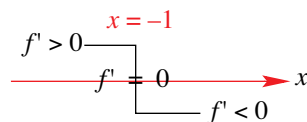

Checking for inflection points:

We have: $f''(x) = 0 \Leftrightarrow 6x - 6 = 0 \Leftrightarrow x = 1$.

For $x < 1$ ($x = 0.9$) $f''(0.9) < 0$ and

for $x > 1$ ($x = 1.1$) $f''(1.1) < 0$.

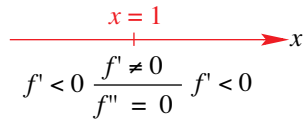

As the sign of the first derivative remains the same on either side of $x = 1$, there is a point of inflection at $(1, -10)$. Then, as the **first derivative** at $x = 1$ is **not zero**, we have a **non-stationary** point of inflection at $x = 1$.

EXAMPLE 20.19

Sketch the graph of the function $f(x) = x^4 - 2x^2$, clearly marking any stationary points and points of inflection.

Solution

We first find the **stationary points** (if any).

This means that we must solve for $f'(x) = 0$:

$$\begin{aligned} \text{Now, } f'(x) &= 4x^3 - 4x = 4x(x^2 - 1) \therefore 4x(x^2 - 1) = 0 \Leftrightarrow 4x(x + 1)(x - 1) = 0 \\ &\Leftrightarrow x = -1 \text{ or } x = 1 \text{ or } x = 0 \end{aligned}$$

We now check for the nature of each point

At $x = 0$: $x = -0.1, f'(-0.1) = 0.396 > 0$

$x = 0.1, f'(0.1) = -0.396 < 0$

Therefore, we have a **local maximum** point at $(0, 0)$.

At $x = 1$:

$x = 0.9, f'(0.9) = -0.684 < 0$

$x = 1.1, f'(1.1) = 0.924 > 0$

Therefore, we have a **local minimum** point at $(1, -1)$.

At $x = -1$:

$x = -0.9, f'(-0.9) = 0.684 > 0$

$x = -1.1, f'(-1.1) = -0.924 < 0$

Hence, we have a **local minimum** point at $(-1, -1)$.

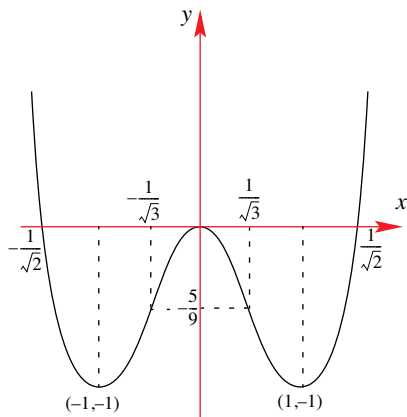

We now look for possible points of inflection.

We need to solve for $f''(x) = 0$:

Now, $f''(x) = 0 \Rightarrow 12x^2 - 4 = 0$

$$\Leftrightarrow 4(3x^2 - 1) = 0$$

$$\Leftrightarrow x = \frac{1}{\sqrt{3}} (\approx 0.58) \text{ or } x = -\frac{1}{\sqrt{3}} (\approx -0.58)$$

$$\text{At } x = \frac{1}{\sqrt{3}}, f\left(\frac{1}{\sqrt{3}}\right) = \left(\frac{1}{\sqrt{3}}\right)^4 - 2\left(\frac{1}{\sqrt{3}}\right)^2 = -\frac{5}{9} \text{ similarly } f\left(-\frac{1}{\sqrt{3}}\right) = -\frac{5}{9}.$$

Next, we **check** to see if these are indeed points of inflection.

At $x = \frac{1}{\sqrt{3}}$ we have:

$$x = 0.5, f'(0.5) \approx -1.5 < 0$$

$$x = 0.6, f'(0.6) \approx -1.54 < 0$$

At $x = -\frac{1}{\sqrt{3}}$ we have:

$$x = -0.5, f'(0.5) \approx 1.5 > 0$$

$$x = -0.6, f'(0.6) \approx 1.54 > 0$$

From the signs of the first derivative, on either side of $x = \frac{1}{\sqrt{3}}$ and $x = -\frac{1}{\sqrt{3}}$ we have

non-stationary points of inflection at $\left(\frac{1}{\sqrt{3}}, \frac{5}{9}\right)$ and $\left(-\frac{1}{\sqrt{3}}, \frac{5}{9}\right)$.

EXAMPLE 20.20

For the function $f: \left[0, \frac{5\pi}{2}\right] \mapsto \mathbb{R}$, where $f(x) = e^{-x} \cos x$, find

- the x -intercepts,
- the co-ordinates of the first two stationary points.
Use the above information to sketch the graph of f .

S
o
l
u
t
i
o
n

- x -intercepts:**

We need to solve for $e^{-x} \cos x = 0 \Leftrightarrow e^{-x} = 0$ or $\cos x = 0$.

As e^{-x} is always positive, we need only concern ourselves with $\cos x = 0$.

Given that $x \in \left[0, \frac{5\pi}{2}\right]$, we have $\cos x = 0 \Leftrightarrow x = \frac{\pi}{2}, \frac{3\pi}{2}, \frac{5\pi}{2}$.

That is, x -intercepts occur at $x = \frac{\pi}{2}, \frac{3\pi}{2}, \frac{5\pi}{2}$

- Stationary points:**

This time we need to solve for $f'(x) = 0$:

$$\begin{aligned} f'(x) &= \frac{d}{dx}(e^{-x}) \times \cos x + e^{-x} \times \frac{d}{dx}(\cos x) \quad \text{[product rule]} \\ &= -e^{-x} \cos x - e^{-x} \sin x \\ &= -e^{-x}(\cos x + \sin x) \end{aligned}$$

So, $f'(x) = 0 \Leftrightarrow -e^{-x}(\cos x + \sin x) = 0 \Leftrightarrow e^{-x} = 0$ or $\cos x + \sin x = 0$

Now, as e^{-x} is always positive we have $f'(x) = 0 \Leftrightarrow \cos x + \sin x = 0$.

Solving for $\cos x + \sin x = 0$ gives $\sin x = -\cos x \Leftrightarrow \frac{\sin x}{\cos x} = -1 \Leftrightarrow \tan x = -1$.

Therefore, $x = \frac{3\pi}{4}$ or $x = \frac{7\pi}{4}$.

Nature of stationary points:

$$\text{For } x = \frac{3\pi}{4} (\approx 2.36) \left. \begin{array}{l} x = 2.3 \text{ then } \frac{dy}{dx} = -0.008 \\ x = 2.4 \text{ then } \frac{dy}{dx} = 0.056 \end{array} \right\} \therefore \text{local minimum at } x = \frac{3\pi}{4}$$

$$\text{For } x = \frac{7\pi}{4} (\approx 5.50) \left. \begin{array}{l} x = 5.4 \text{ then } \frac{dy}{dx} = 0.0006 \\ x = 5.6 \text{ then } \frac{dy}{dx} = -0.0005 \end{array} \right\} \therefore \text{local maximum at } x = \frac{7\pi}{4}$$

Now, at $x = \frac{3\pi}{4}, y = e^{-\frac{3\pi}{4}} \cos\left(\frac{3\pi}{4}\right) = -\frac{\sqrt{2}}{2} e^{-\frac{3\pi}{4}}$, and at $x = \frac{7\pi}{4}, y = e^{-\frac{7\pi}{4}} \cos\left(\frac{7\pi}{4}\right) = \frac{\sqrt{2}}{2} e^{-\frac{7\pi}{4}}$

Note: The graph shown has been scaled so that the general shape can be seen more readily. In fact, the local maximum should be very close to the x -axis.

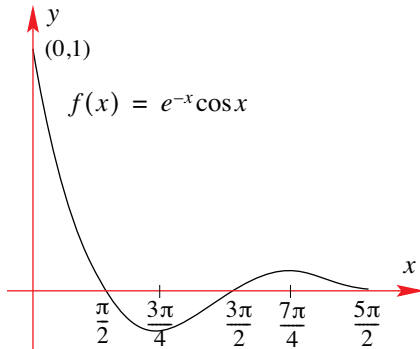

Notice that over the specified domain, the TI-83 produces the following graph:

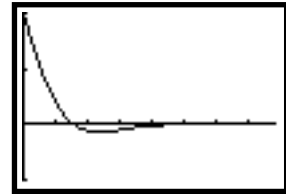

Also note that the behaviour of $f(x)$ takes on the combined behaviour of the decaying function, e^{-x} , and the oscillating function, $\cos(x)$.

20.2.3 GLOBAL MAXIMA AND MINIMA

Until now we have only considered locating the **local maxima** or the **local minima**. The process has been straightforward enough in the sense that there exists a procedure for locating these points, i.e., find the derivative, equating it to zero, solve and then use a sign diagram of the first derivative to identify the nature of the stationary point.

Consider the function $f(x) = 4x^3 + 9x^2 - 12x + 10$. Assuming that we have been able to find the stationary points we can sketch the graph of $f(x)$:

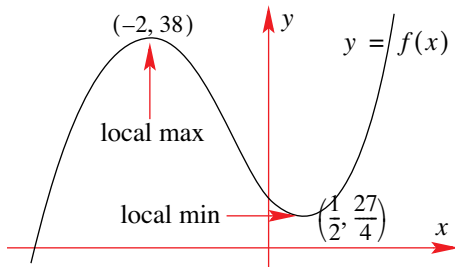

Going through our standard process we find that the curve has a

local maximum at $(-2, 38)$

and a

local minimum at $\left(\frac{1}{2}, \frac{27}{4}\right)$.

In sketching this curve we have (correctly) assumed that $x \in \mathbb{R}$ and as such the graph extends indefinitely and as such, no overall minimum or maximum can be given. However, what if we wished to find the maximum value of this function but this time have a restriction on the domain, e.g., $f(x) = 4x^3 + 9x^2 - 12x + 10, -3 \leq x \leq 2$.

In this instance, proceeding with our standard approach, i.e., finding the derivative and so forth gives the same results as above. However, we should now sketch the graph over the given domain. A sketch of this graph over the given domain is now produced:

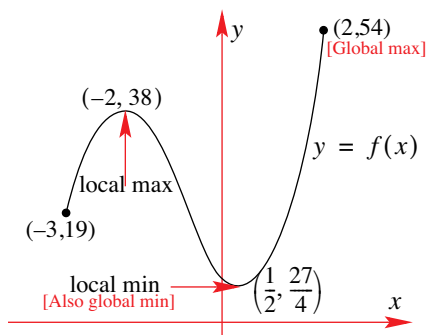

From the sketch we can see that although the point $(-2, 38)$ is still a stationary point, it only identifies the local maximum.

Over the new domain, the maximum value of $f(x)$ is in fact 54. We say that $f(x)$ has an endpoint maximum. This **endpoint** maximum occurs at $(2, 54)$. Then, as there is no other value greater than 54, we also say that the **global maximum** or the **absolute maximum** is 54.

Notice too that the point $(\frac{1}{2}, \frac{27}{4})$ is both a local minimum **and** a **global minimum**, because for this domain the minimum value of $f(x)$ is $\frac{27}{4}$, which happens to coincide with the local minimum. Had the domain been $-4 \leq x \leq 2$, then the **absolute minimum** would have occurred at $x = -4$ with a value of $f(-4) = -54$.

So, when using the term ‘**local**’ we are in fact referring to points that are in the **immediate vicinity** (or **neighbourhood**) of the **critical point** (see definition below).

Notice also that the derivative, $f'(x)$, does not exist at $(2, 54)$ [or $(-3, 19)$ for that matter] – however, we still have a maximum at that point.

Why is it that the derivatives does not exist at these end point?

It should also be observed that there can be a local maximum or a local minimum for which the derivative is undefined at that point. We extend our definition of **local extrema** as follows:

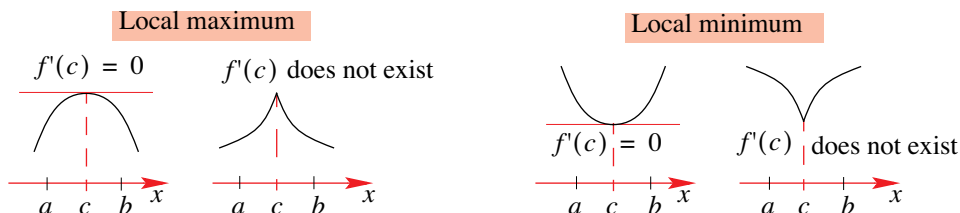

If f has a local maximum or a local minimum when $x = c$, where $a < c < b$, then c is a critical value of f . That is, either $f'(c) = 0$ or $f'(c)$ does not exist.

EXAMPLE 20.21

Find the critical value(s) of the function $f(x) = 2x - 3x^{2/3}$.

To determine the critical value(s) we must first find $f'(x)$:

$$f'(x) = 2 - 2x^{-1/3} = 2\left(1 - \frac{1}{x^{1/3}}\right) = 2\left(\frac{x^{1/3} - 1}{x^{1/3}}\right).$$

Next we must find value(s) of c such that $f'(c) = 0$ or $f'(c)$ does not exist.

$$\text{So, } f'(x) = 0 \Leftrightarrow 2\left(\frac{x^{1/3} - 1}{x^{1/3}}\right) = 0 \Leftrightarrow x^{1/3} - 1 = 0 \Leftrightarrow x = 1.$$

MATHEMATICS – Higher Level (Core)

However, $f'(x)$ will be undefined if $x = 0$ (as division by 0 is not possible). So, we might also have a critical value at $x = 0$ (one for which the derivative is undefined).

In fact, a sketch of the function shows the critical points as well as the local **extrema**.

When $x = 1$, $f(1) = 2 - 3 = -1$ and when $x = 0$, $f(0) = 0$ and so we have local extrema at $(1, -1)$ and $(0, 0)$.

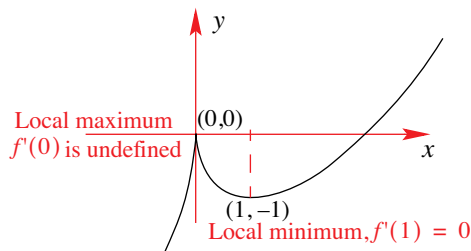

EXAMPLE 20.22

$$\text{Given that } f(x) = \begin{cases} x^2 - 6x + 8 & \text{where } 1 \leq x < 4 \\ x + 2 & \text{where } -5 \leq x < 1 \end{cases}$$

- Find all critical values of f .
- Find the absolute maximum of f .

S
o
l
u
t
i
o
n

We start by sketching the graph of f :

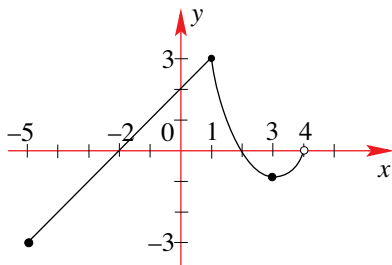

To determine the stationary point we solve

$$\frac{d}{dx}(x^2 - 6x + 8) = 0 \Leftrightarrow 2x - 6 = 0 \Leftrightarrow x = 3.$$

That is, $x = 3$ is a critical value.

However there is another critical value, where $f'(x)$ does not exist. Namely, $x = 1$.

Note that $x = -5$ provides an end point extremum.

- We then have:
- An **absolute minimum** at $x = -5$.
 - An **absolute maximum** at the critical value $x = 1$.
 - A **local minimum** at the critical value $x = 3$.

Note: Even though $\lim_{x \rightarrow 4^-} f(x) = 0$, we cannot refer to this point as an end point extremum, as a value of $f(x)$ is not defined at this point.

EXAMPLE 20.23

For the function $h(x) = (x - 1)x^{2/3}$, $-1 \leq x \leq 2$.

- Find its critical value(s).
- Find the coordinates of the i. local minimum ii. absolute minimum.
- Find the coordinates of the i. local maximum ii. absolute maximum.
- Find its point(s) of inflection.
- Sketch the graph of h .

Solution We start by using the graphics calculator to get an idea of the general shape of the curve.

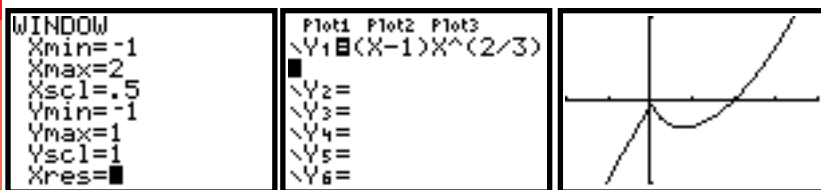

- (a) Our first step in finding critical values is to solve for $h'(x) = 0$.

$$\begin{aligned} \text{Now, } h(x) = (x-1)x^{2/3} \Rightarrow h'(x) &= 1 \times x^{2/3} + (x-1) \times \frac{2}{3}x^{-1/3} = x^{2/3} + \frac{2(x-1)}{3x^{1/3}} \\ &= \frac{3x + 2(x-1)}{3x^{1/3}} \\ &= \frac{5x-2}{3x^{1/3}} \end{aligned}$$

$$\text{Therefore, } h'(x) = 0 \Leftrightarrow \frac{5x-2}{3x^{1/3}} = 0 \Leftrightarrow x = \frac{2}{5} = 0.4$$

And so, there is only one critical value that is a stationary point.

However, we also note that $h'(x)$ is undefined at $x = 0$, and from the graph above we see that this is also a critical value. In fact, we see that there is a **cusp**¹ at $x = 0$.

- (b) i. Using the above graph as an aid we have the local minimum occurring at $x = 0.4$, with coordinates $\left(0.4, -\frac{3}{5}\sqrt[3]{\left(\frac{2}{5}\right)^2}\right)$. i.e., $h\left(\frac{2}{5}\right) = \left(\frac{2}{5} - 1\right)\left(\frac{2}{5}\right)^{2/3} = -\frac{3}{5}\sqrt[3]{\left(\frac{2}{5}\right)^2}$.
- ii. The absolute minimum occurs at the end point where $x = -1$.
- (c) i. The local maximum, even though $h'(x)$ is undefined there, occurs where $x = 0$. The coordinates of the local maximum are $(0, 0)$.
- ii. The absolute maximum occurs at the endpoint where $x = 2$.
Now, $h(2) = (2-1) \times 2^{2/3} = 2^{2/3}$, therefore the coordinates of the absolute maximum are at $(2, 2^{2/3})$.

- (d) For possible points of inflection we first solve $h''(x) = 0$.

$$\begin{aligned} \text{Now, } h'(x) &= \frac{1}{3}(5x-2)x^{-1/3} \therefore h''(x) = \frac{1}{3}\left[5 \times x^{-1/3} + (5x-2) \times -\frac{1}{3}x^{-4/3}\right] \\ &= \frac{1}{3}\left[\frac{15x - (5x-2)}{3x^{4/3}}\right] \\ &= \frac{1}{9} \cdot \frac{10x+2}{x^{4/3}} \end{aligned}$$

$$\text{Then, } h''(x) = 0 \Leftrightarrow \frac{10x+2}{9x^{4/3}} = 0 \Leftrightarrow x = -\frac{2}{10} = -0.2.$$

Again, making use of the graph from our graphics calculator. We see that as $h'(x) > 0$ for $x < -0.2$, $h'(x) > 0$ for $x > -0.2$ and $h''(x) = 0$ at $x = -0.2$, then there is a (non-stationary) point of inflection at $x = -0.2$.

¹ We will say more about cusps in the next section.

MATHEMATICS – Higher Level (Core)

- (e) We are now in a position to sketch the graph of $h(x)$. Of course, we are also using the display from the graphics calculator as an aid – and it should be noted that in this case the graphics calculator has not clearly displayed the inflection behaviour at $x = -0.2$.

Using the available information we have gathered, we can now sketch the graph of h :

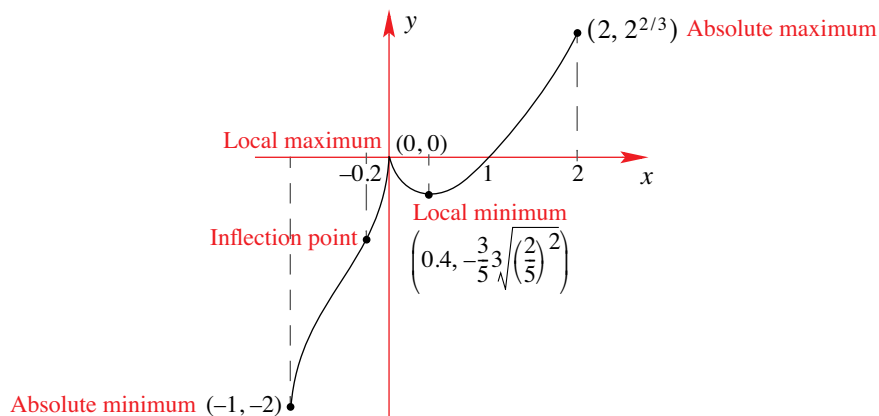

Note: The following section lies outside the scope of the course – we include it as an extension.

20.2.4 VERTICAL TANGENTS AND CUSPS

In the previous section we looked at critical points and how to find them. In this section we take a closer look at the properties of graphs that have critical points for which the derivative does not exist yet still provide a local (or **relative**) extrema. We also look at graphs for which neither a local maximum nor a local minimum exists at points where the first derivative does not exist.

We first display the graphs of such functions and then provide a definition. Note that in all cases we have that $f'(c)$ does not exist. In all four cases a **vertical tangent** exists at $x = c$.

The graph of the function has a **vertical tangent line** at $x = c$ if f is continuous at $x = c$ and $|f'(x)| \rightarrow +\infty$ as $x \rightarrow c$.

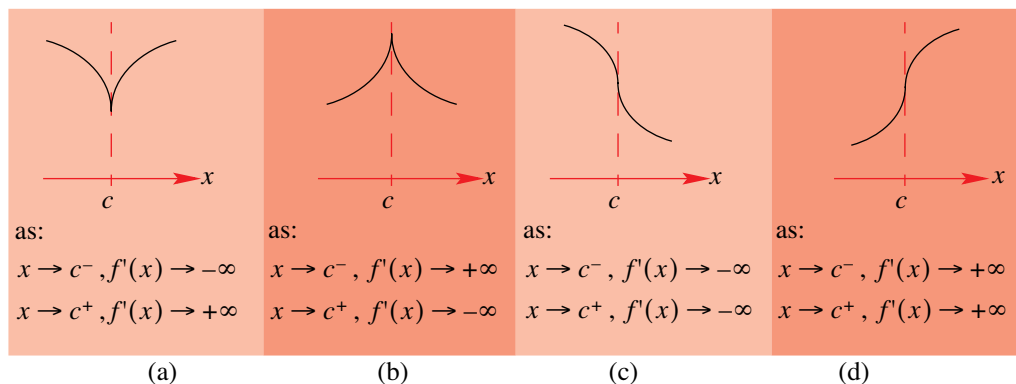

Figures (a) and (b):

The graph of the function has a **cusp** at $x = c$ if f is continuous at c and $f'(x) \rightarrow +\infty$ as $x \rightarrow c$ from one side of $x = c$ and $f'(x) \rightarrow -\infty$ as $x \rightarrow c$ from the other side of $x = c$.

EXAMPLE 20.24

 Sketch the graph of $f(x) = x^{1/3}$.

**S
o
l
u
t
i
o
n**

We approach this question in two ways.

The first is to realise that $f(x) = x^{1/3}$ is in fact the inverse of the x^3 function. That is, if we consider the function $g(x) = x^3$ we can determine its inverse as follows:

$$g(g^{-1}(x)) = x \Leftrightarrow [g^{-1}(x)]^3 = x \Leftrightarrow g^{-1}(x) = \sqrt[3]{x} \text{ i.e., } g^{-1}(x) = x^{1/3}.$$

Then, as $g(x) = x^3$ has a stationary point of inflection at $x = 0$, the tangent at $x = 0$ must be parallel to the x -axis, i.e., it has a **horizontal tangent** at $x = 0$. This then means that **its inverse**, i.e., $g^{-1}(x) = x^{1/3}$ would have a **vertical tangent** at $x = 0$.

Sketching the function $f(x) = x^{1/3}$ would then require us to reflect the graph of $g(x) = x^3$ about the line $y = x$.

The second method makes use of the definitions we have just looked at. We start by finding the derivative: $f(x) = x^{1/3} \Rightarrow f'(x) = \frac{1}{3}x^{-2/3} = \frac{1}{3x^{2/3}}$ then, at $x = 0$, the derivative is undefined.

However this is **not enough**¹ to imply that we have a vertical tangent. We need to look at **some more features** of the graph before we can **conclude** that we have a **vertical tangent** at $x = 0$. We produce a list of features that will allow us to conclude that we have a vertical tangent at $x = 0$:

1. $f'(x)$ is undefined at $x = 0$.
2. $f(x)$ is continuous at $x = 0$.
3.
 - i. as $x \rightarrow 0^-$, $f'(x) \left(= \frac{1}{3x^{2/3}} \right) \rightarrow +\infty$.
 - ii. as $x \rightarrow 0^+$, $f'(x) \left(= \frac{1}{3x^{2/3}} \right) \rightarrow +\infty$.

As all three conditions hold true, we must have a vertical tangent at $x = 0$.

We can now sketch the graph of the function $f(x) = x^{1/3}$:

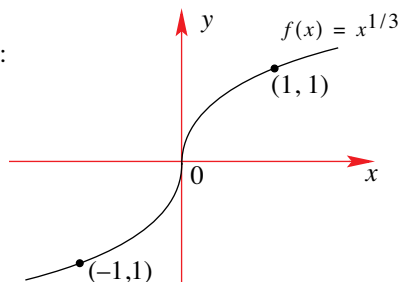

1. Note that the derivative of the function $f(x) = \frac{1}{x}$ is undefined at $x = 0$, but it does not have a vertical tangent at that point.

EXAMPLE 20.25

Sketch the graph of $f(x) = (x - 2)^{2/3} + 1$.

S
o
l
u
t
i
o
n

A quick sketch of $f(x) = (x - 2)^{2/3} + 1$ using the TI-83 shows us enough to suspect that there is a vertical tangent at $x = 2$, in fact, we suspect that it is a cusp.

We now confirm this formally:

As $f(x) = (x - 2)^{2/3} + 1 \Rightarrow f'(x) = \frac{2}{3}(x - 2)^{-1/3} = \frac{2}{3(x - 2)^{1/3}}$

Then, as

1. $f'(x)$ is undefined at $x = 2$.
2. $f(x)$ is continuous at $x = 2$.

- and
3. i. as $x \rightarrow 2^-$, $f'(x) (= \frac{2}{3(x - 2)^{1/3}}) \rightarrow -\infty$
 - ii. as $x \rightarrow 2^+$, $f'(x) (= \frac{2}{3(x - 2)^{1/3}}) \rightarrow +\infty$

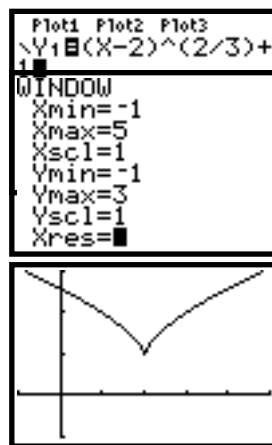

We have a vertical tangent at $x = 2$ and the curve forms a cusp at this point. This is shown in the sketch of $f(x) = (x - 2)^{2/3} + 1$:

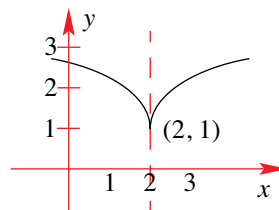

20.2.5 SUMMARY

A lot of ground has been covered with the many definitions encountered. So, below is a visual summary of the definitions we have covered to date.

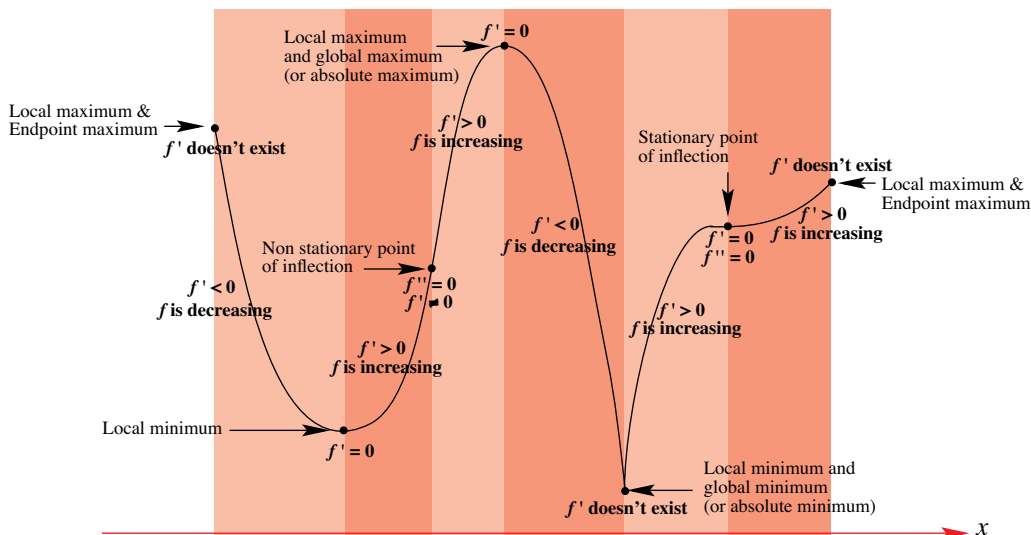

EXERCISES 20.2

- 1.** Draw a sketch of the graph of the function $f(x)$, $x \in \mathbb{R}$, where,
- $f(1) = 2$, $f'(1) = 0$, $f(3) = -2$, $f'(3) = 0$, $f'(x) < 0$ for $1 < x < 3$ and $f'(x) > 0$ for $x > 3$ and $x < 1$.
 - $f'(2) = 0$, $f(2) = 0$, $f'(x) > 0$ for $0 < x < 2$ and $x > 2$, $f'(x) < 0$ for $x < 0$ and $f(0) = -4$.
 - $f(4) = f(0) = 0$, $f'(0) = f'(3) = 0$, $f'(x) > 0$ for $x > 3$ and $f'(x) < 0$ for $x < 0$ and $0 < x < 3$.
 - $f(4) = 4$, $f'(x) > 0$ for $x > 4$, $f'(x) < 0$ for $x < 4$, as $x \rightarrow 4^+$, $f'(x) \rightarrow +\infty$ and as $x \rightarrow 4^-$, $f'(x) \rightarrow -\infty$.
- 2.** Find the coordinates and nature of the stationary points for the following:
- $y = 3 + 2x - x^2$
 - $y = x^2 + 9x$
 - $y = x^3 - 27x + 9$
 - $f(x) = x^3 - 6x^2 + 8$
 - $f(x) = 3 + 9x - 3x^2 - x^3$
 - $y = (x - 1)(x^2 - 4)$
 - $f(x) = x - 2\sqrt{x}$, $x \geq 0$
 - $g(x) = x^4 - 8x^2 + 16$
 - $y = (x - 1)^2(x + 1)$
 - $y = x\sqrt{x} - x$, $x \geq 0$
 - $g(x) = x + \frac{4}{x}$, $x \neq 0$
 - $f(x) = x^2 + \frac{1}{x^2}$, $x \neq 0$
- 3.** Sketch the following functions:
- $y = 5 - 3x - x^2$
 - $f(x) = x^2 + \frac{1}{2}x + \frac{3}{4}$
 - $f(x) = x^3 + 6x^2 + 9x + 4$
 - $f(x) = x^3 - 4x$
 - $f(x) = \frac{1}{3}x^3 - x^2 + 4$
 - $y = 4x^3 - x^4$
 - $y = x^3 - 8$
 - $y = x^4 - 16$
 - $y = x - 4x\sqrt{x}$, $x \geq 0$
 - $f(x) = x - 2\sqrt{x}$, $x \geq 0$
- 4.** Find and describe the nature of all stationary points and points of inflection for the function $f(x) = x^3 + 3x^2 - 9x + 2$.
- 5.** Sketch the graph of $x \mapsto x^4 - 4x^2$.
- 6.** A function f is defined by $f: x \mapsto e^{-x} \sin x$, where $0 \leq x \leq 2\pi$.
- Find
 - $f'(x)$
 - $f''(x)$
 - Find the values of x for which
 - $f'(x) = 0$
 - $f''(x) = 0$
 - Using parts (a), and (b), find the points of inflection and stationary points for f .
 - Hence, sketch the graph of f .

MATHEMATICS – Higher Level (Core)

- 7.** A function f is defined by $f: x \mapsto e^x \sin x$, where $0 \leq x \leq 2\pi$.
- Find i. $f'(x)$ ii. $f''(x)$
 - Find the values of x for which
 - $f'(x) = 0$
 - $f''(x) = 0$
 - Using parts (a) and (b), find the points of inflection and stationary points for f .
 - Hence, sketch the graph of f .
- 8.** A function f is defined by $f: x \mapsto e^x \cos x$, where $0 \leq x \leq 2\pi$.
- Find i. $f'(x)$ ii. $f''(x)$
 - Find the values of x for which
 - $f'(x) = 0$
 - $f''(x) = 0$
 - Using parts (a) and (b), find the points of inflection and stationary points for f .
 - Hence, sketch the graph of f .
- 9.** A function f is defined by $f: x \mapsto xe^{-x}$, where $x > 0$.
- Find i. $f'(x)$ ii. $f''(x)$
 - Find the values of x for which
 - $f'(x) = 0$
 - $f''(x) = 0$
 - Using parts (a) and (b), find the points of inflection and stationary points for f .
 - Hence, sketch the graph of f .
- 10.**
- Find the maximum value of the function $y = 6x - x^2$, $4 \leq x \leq 7$.
 - Find the minimum value of the function $y = 6x - x^2$, $2 \leq x \leq 6$.
 - Find the maximum value of the function $y = 2x - x^3$, $-2 \leq x \leq 6$.
 - Find the maximum value of the function $y = 36x - x^4$, $2 \leq x \leq 3$.

- 11.** For the function $f(x) = \frac{1}{3}x^3 - x^2 - 3x + 8$, $-6 \leq x \leq 6$ find;
- its minimum value,
 - its maximum value.

- 12.** For each of the labelled points on the following graphs state
- whether the derivative exists at the point.
 - the nature of the curve at the point.

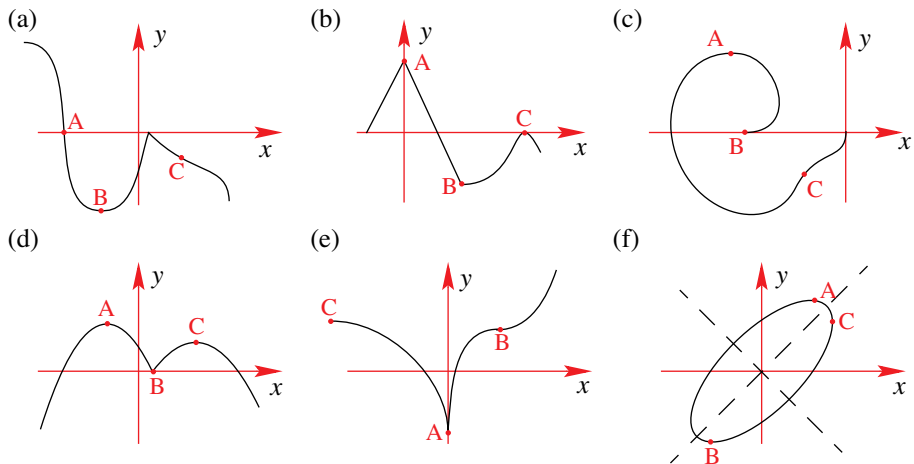

13. Identify which graph corresponds to

- i. $f(x)$ ii. $f'(x)$ iii. $f''(x)$
 (a) (b)

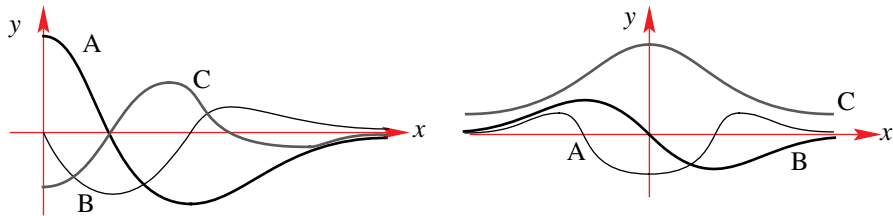

14. For each of the functions, $f(x)$, sketch (a) $f'(x)$ (b). $f''(x)$

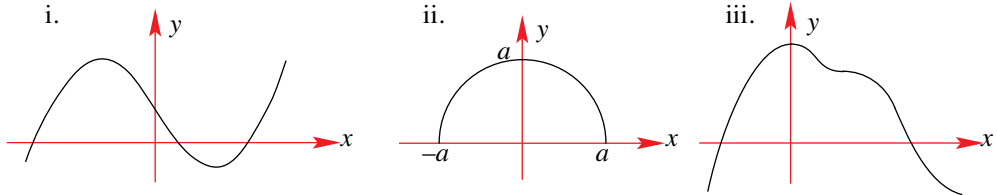

15. The curve with equation $y = ax^3 + bx^2 + cx + d$ has a local maximum where $x = -3$ and a local minimum where $x = -1$. If the curve passes through the points $(0, 4)$ and $(1, 20)$ sketch the curve for $x \in \mathbb{R}$.

16. The function $f(x) = ax^3 + bx^2 + cx + d$ has turning points at $(-1, -\frac{13}{3})$ and $(3, -15)$. Sketch the graph of the curve $y = f(x)$.

17. The function $f: x \mapsto \mathbb{R}$, where $f(x) = ax^5 + bx^3 + cx$ has stationary points at $(-2, 64)$, $(2, -64)$ and $(0, 0)$. Find the values of a , b and c and hence sketch the graph of f .

18. Sketch the graph of the curve defined by the equation $y = x(10x - \ln x)$, $x > 0$ identifying, where they exist, all stationary points and points of inflection.

19. Find m and n so that $f'(1)$ exists for the function $f(x) = \begin{cases} mx^2 + n & \text{if } x \leq 1 \\ \frac{1}{x} & \text{if } x > 1 \end{cases}$.

20. Consider the function $f(x) = (x - a)(x - 4)^{1/b}$.

(a) Sketch the graph of f for the case where

- i. $a = 4$ and $b = 2$.
 ii. $a = 2$ and $b = 2$.

(b) Find

- i. $f'(x)$ if $a = 4$ and $b = 2$.
 ii. $f'(x)$ if $a = 2$ and $b = 2$.

For each of i. and ii., in (b) find all stationary points and where $f'(x)$ is undefined.

MATHEMATICS – Higher Level (Core)

- 21.** The curve with equation $y = ax^3 + bx^2 + cx + 5$ has a stationary point at $(0, 5)$, an x -intercept at $x = -1$ and an inflection point where $x = 0.5$. Find the values of a, b and c .
- 22.** Sketch the curve of the function with equation $y = (1 + x)^2e^{-x}$ identifying, if they exist, all stationary points and points of inflection.
- 23.** The function $f(x) = (x^2 + bx + c)e^x$ passes through the point $(-2, 0)$ and the point $(1, 0)$. Sketch the graph of f identifying, if they exist, all stationary points and points of inflection.
- 24.*** Sketch the graphs of the functions
- (a) i. $g(x) = (x + 2)^{2/3}$ ii. $f(x) = (x + 2)^{1/3}$
(b) i. $h(x) = (x - 4)^{3/2} + 2$ ii. $h(x) = (x - 4)^{2/3} + 2$
- 25.*** Sketch the graphs of the functions
- (a) $f(x) = 5x^{4/5} - 4x$ (b) $h(x) = \frac{1}{2}x^2 - 3x^{5/3}$
(c) $g(x) = x^{2/3}(x - 3)$ (d) $g(x) = x^{3/2}(x - 3)$
- 26.*** Determine the values of x for which the function $f(x) = (x^2 - 4)^{2/3}$ is increasing. Sketch the graph of f identifying, if they exist, all stationary points and points of inflection.
- 27.*** (a) Find the local maximum, local minimum and inflection point for the function $f(x) = 5x^{2/3} - x^{5/3}$.
(b) Sketch the graph of $f(x) = 5x^{2/3} - x^{5/3}$,
(c) Find the maximum value of $f(x)$ over the interval $-2 \leq x \leq 6$.
- 28.** The curve with equation $y = ax^3 + bx^2 + cx + d$ intersects the x -axis at $x = 1$ and cuts the y -axis at $(0, -34)$. Given that the curve has turning points at $x = 3$ and $x = 5$, determine the values of a, b, c and d . Sketch this curve.
- 29.** (a) Given that $f(x) = axe^{-bx^2}$, show that $f''(x) = 2abx(2bx^2 - 3)e^{-bx^2}$. Hence show that there can be at most three points of inflection.
(b) If $f(x)$ has a stationary point where $x = \frac{1}{\sqrt{2}}$, find the value of b .
(c) For what value of a will the graph of the function pass through the point $(\sqrt{2}, e^{-2})$?
(d) Using the values of a and b found in parts (b) and (c), sketch the graph of the function.
- 30.** (a) Find the smallest three positive critical values of $f(\theta) = \frac{\cos \theta}{\theta}$, $\theta \neq 0$.
(c) Sketch the graph of the function $f(\theta) = \frac{\cos \theta}{\theta}$, $0 < \theta \leq 4\pi$.





* Functions such as these lie outside the scope of the syllabus. They have been included so that they can be used as part of classroom discussions.

20.3 THE SECOND DERIVATIVE AND ITS APPLICATIONS

20.3.1 DEFINITION

We have already encountered the second derivative, however, we have only done so as a process rather than as an in depth study. We now revisit the second derivative and look at its other uses.

Remember that if a function is differentiated twice, we obtain the **second derivative** of the function. The second derivative measures the rate at which the first derivative is changing.

If this **second derivative is small**, it means the first derivative is changing slowly and that the curve will look a bit like:  or  with a **small curvature**. If the **second derivative is a large positive** number, the gradient is increasing rapidly and the curve will look a bit like this: , that is, a **large curvature**. For similar reasons, a **large negative value** for the second derivative means that the gradient of the curve is decreasing rapidly and the graph should look a bit like this: . Again, producing a **large curvature**.

We now define the term **concavity** and look at its relationship to the second derivative.

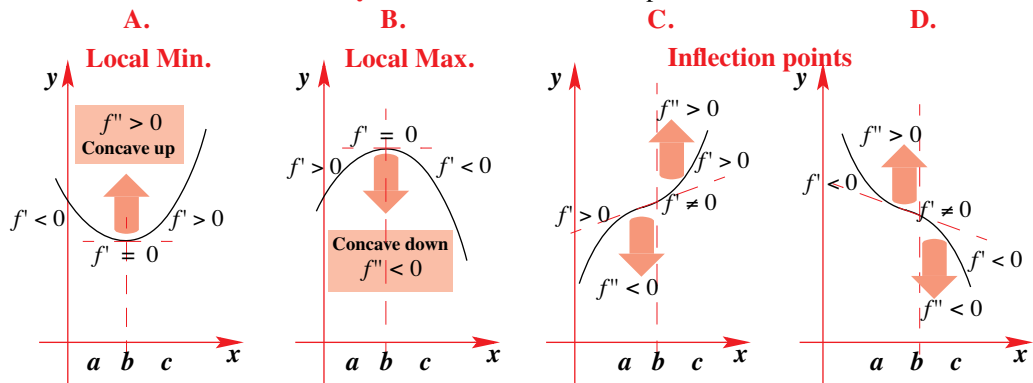

Graph A

As the x -values increase from a to b to c , i.e., from left to right, then the values of f' increase from $-ve$ to 0 to $+ve \Rightarrow f'' > 0 \Rightarrow$ a local minimum at $x = b$

Graph B

As the x -values increase from a to b to c , i.e., from left to right, then the values of f' decrease from $+ve$ to 0 to $-ve \Rightarrow f'' < 0 \Rightarrow$ a local maximum at $x = b$

Graph C

As the x -values increase from a to b to c , i.e., from left to right, then the values of f' decrease from $+ve$ to smaller $+ve$ numbers and then increase to larger $+ve$ numbers. However, this time f'' changes sign at $x = b$, from $-ve$ values to $+ve$ values

\Rightarrow a point of inflection at $x = b$ (i.e., a non-stationary point of inflection).

Graph D

As the x -values increase from a to b to c , i.e., from left to right, then the values of f' decrease from $-ve$ to more $-ve$ numbers and then increase to less $-ve$ numbers. However, this time f'' changes sign at $x = b$, from $+ve$ values to $-ve$ values \Rightarrow a point of inflection at $x = b$ (i.e., a non-stationary point of inflection).

Note that a special case of Graphs C and D is where a stationary point occurs at $x = b$:

In such cases we say that a **stationary point of inflection** occurs at $x = b$.

That is at $x = b$ $f'' = 0$, $f' = 0$ and the sign of the second derivative changes (either from $-ve$ to $+ve$ or from $+ve$ to $-ve$).

This situation has been addressed in detail earlier in this chapter

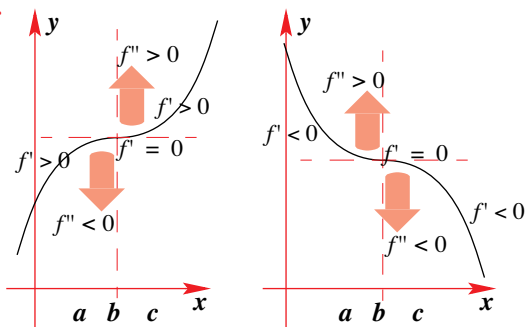

We can use the following sequence of derivatives to summarise our observations so far.

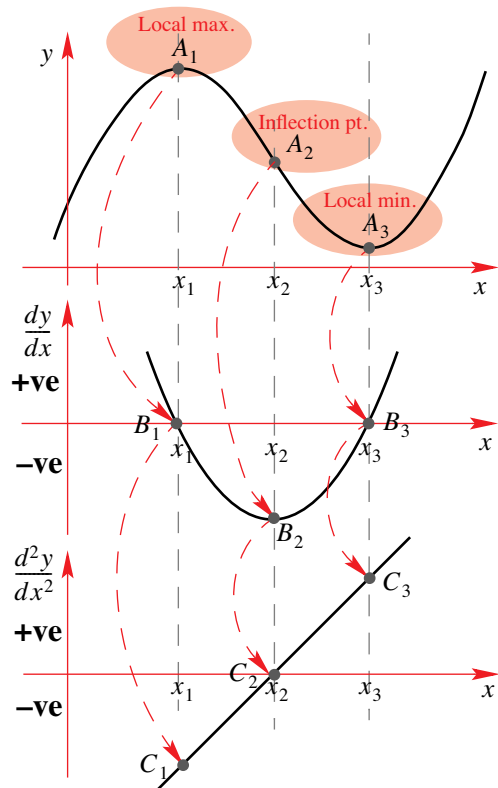

Local Maximum: $A_1 \rightarrow B_1 \rightarrow C_1$
 So that at a local maximum we have that

- $\frac{dy}{dx} = 0$
- $\frac{d^2y}{dx^2} < 0$

Inflection point: $A_2 \rightarrow B_2 \rightarrow C_2$
 So that at a point of inflection we have

Case A –
 A non stationary point of inflection

- $\frac{dy}{dx} \neq 0$
- $\frac{d^2y}{dx^2} = 0$

and there is a change in the sign of the second derivative near x_2 .

Case B –
 A stationary point of inflection

- $\frac{dy}{dx} = 0$
- $\frac{d^2y}{dx^2} = 0$

and there is a change in the sign of the second derivative near x_2 .

Local Minimum: $A_3 \rightarrow B_3 \rightarrow C_3$
 So that at a local minimum we have that

- $\frac{dy}{dx} = 0$
- $\frac{d^2y}{dx^2} > 0$

EXAMPLE 20.26

Determine the values of x for which the function $f(x) = x^3 - 3x^2$ is concave up.

**S
o
l
u
t
i
o
n**

By definition, $f(x)$ will be concave up for those values of x where $f''(x) < 0$.

Now, $f'(x) = 3x^2 - 6x \therefore f''(x) = 6x - 6$.

Then, $f''(x) < 0 \Leftrightarrow 6x - 6 < 0 \Leftrightarrow x < 1$.

i.e., $f(x)$ is concave up for $x \in]-\infty, 1[$.

The use of a graphics calculator can confirm this result.

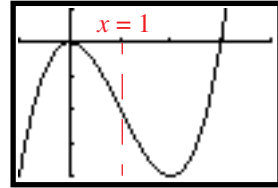
EXAMPLE 20.27

Find the first and second derivatives of the function:

$$f(x) = 2x^5 - 5x^4 - 10x^3, x \in [-5, 5]$$

Hence find the coordinates and nature of all the stationary points of the function.

**S
o
l
u
t
i
o
n**

$$f(x) = 2x^5 - 5x^4 - 10x^3 \Rightarrow f'(x) = 10x^4 - 20x^3 - 30x^2$$

$$\therefore f''(x) = 40x^3 - 60x^2 - 60x$$

We can locate the stationary points by equating the first derivative to zero:

$$10x^4 - 20x^3 - 30x^2 = 0 \Leftrightarrow 10x^2(x^2 - 2x - 3) = 0$$

$$\Leftrightarrow 10x^2(x - 3)(x + 1) = 0$$

$$\Leftrightarrow x = -1, 0, 3$$

Next, we must use a test of some sort to discriminate between the types of stationary point. Using the second derivative test, we have the following.

$$x = -1: f''(x) = 40x^3 - 60x^2 - 60x \therefore f''(-1) = 40(-1)^3 - 60(-1)^2 - 60(-1) = -40$$

From this we can infer that in the region of the stationary point, the gradient of the curve is decreasing. This means that the general shape must be: and that we have a local

maximum. The y -coordinate of this point is $f(-1) = 2(-1)^5 - 5(-1)^4 - 10(-1)^3 = 3$.

At the origin, both $f'(0) = 0$ and $f''(0) = 0$. However we can draw no conclusion as yet from this information as it could represent either a stationary point of inflection or a turning point. A second test is required which might be to look at the sign of the first derivative just to the left and just to the right of the stationary point:

$$f'(-0.01) = 10(-0.01)^4 - 20(-0.01)^3 - 30(-0.01)^2 = -0.0029799$$

$$f'(0.01) = 10(0.01)^4 - 20(0.01)^3 - 30(0.01)^2 = -0.0030199$$

Since the gradient is negative both to the left and right of $x = 0$, it follows that we have a descending stationary inflection point. The y -coordinate of this point is $f(0) = 0$.

Finally, $f''(3) = 40(3)^3 - 60(3)^2 - 60(3) = 360$ so that in the region of the stationary point at $x = 3$ the gradient is increasing so the graph must have the general shape: and the stationary point is a local minimum. The y -coordinate of this point is $f(3) = -189$.

In summary, there is a local maximum at $(-1, 3)$, a descending inflection at the origin and a local minimum at $(3, -189)$.

MATHEMATICS – Higher Level (Core)

This graph is an example of one which is difficult to see using a graphics calculator. If you look at the graph using a window which will show the stationary points, you will probably miss the detail in the area of the origin.

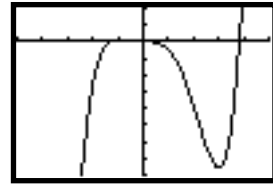

By contrast, if you only look at the region around the origin, you might well miss the minimum at $(3, -189)$.

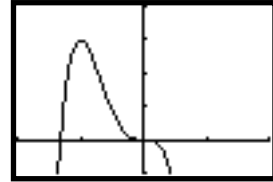

You should be careful when using a graphics calculator to show graphs and are advised to think carefully about the best way(s) of viewing them. In this example, the shape of the graph cannot be seen from a single window.

EXAMPLE 20.28

Determine the values of x for which the function $f(x) = \sin^2 x$ is concave down over the interval $[0, 2\pi]$.

S
o
l
u
t
i
o
n

$$f(x) = \sin^2 x \Rightarrow f'(x) = 2(\cos x)(\sin x) = \sin 2x \therefore f''(x) = 2 \cos 2x$$

$$f(x) = \sin^2 x \text{ is concave down where } f''(x) < 0 \Leftrightarrow 2 \cos 2x < 0$$

$$\text{Consider the solution to } 2 \cos 2x = 0, \text{ i.e., } \cos 2x = 0 \therefore 2x = \frac{\pi}{2}, \frac{3\pi}{2}, \frac{5\pi}{2}, \frac{7\pi}{2}$$

$$\therefore x = \frac{\pi}{4}, \frac{3\pi}{4}, \frac{5\pi}{4}, \frac{7\pi}{4}$$

Then, using the graph of $f''(x) = 2 \cos 2x$ as an aid, we have

$$\text{that } f''(x) < 0 \text{ if } \frac{\pi}{4} < x < \frac{3\pi}{4} \text{ or } \frac{5\pi}{4} < x < \frac{7\pi}{4}.$$

$$\text{i.e., } x \in \left] \frac{\pi}{4}, \frac{3\pi}{4} \right[\cup \left] \frac{5\pi}{4}, \frac{7\pi}{4} \right[.$$

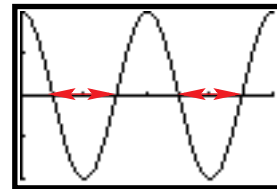

EXAMPLE 20.29

The graph of the function $f(x) = \frac{\sin x}{x}, -2\pi < x < 0$ is concave up over the interval $a < x < b$. Find the values of a and b to two decimal places.

S
o
l
u
t
i
o
n

$$f(x) = \frac{\sin x}{x} \therefore f'(x) = \frac{(\cos x)x - (\sin x) \times 1}{x^2} = \frac{x \cos x - \sin x}{x^2}.$$

Then,

$$f''(x) = \frac{(\cos x - x \sin x - \cos x) \times x^2 - 2x \times (x \cos x - \sin x)}{x^4} = \frac{2x \sin x - 2x^2 \cos x - x^3 \sin x}{x^4}$$

$$= \frac{2 \sin x - 2x \cos x - x^2 \sin x}{x^3}$$

We now need to find those values of x for which $f''(x) < 0$.

We start by finding where $f''(x) = 0$ and then make use of a graph to identify the inequality.

The solution to $f''(x) = 0$ is provided by setting $\frac{2\sin x - 2x\cos x - x^2\sin x}{x^3} = 0$. That is, by

solving $2\sin x - 2x\cos x - x^2\sin x = 0$ – which unfortunately cannot be readily solved. Seeing as we require answers to two decimal places, we make use of the graphics calculator:

Using the solve function we obtain the solutions $x = -2.08$ and $x = -5.94$

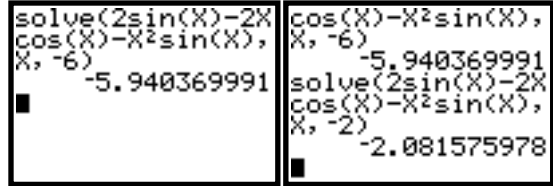

To determine the set of values for which the inequality $f''(x) < 0$ holds, we use the graph of $f(x)$ as an aid. From the graph of $f(x)$ we have:

$$f''(x) < 0 \Leftrightarrow -5.95 < x < -2.08$$

Therefore, $a = -5.94$ and $b = -2.08$

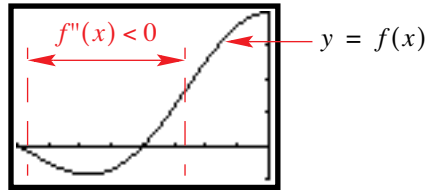

We now consider the previous problem and solve it by using the **nDerive** function on the TI-83:

We start by entering the equation of the function $f(x) = \frac{\sin x}{x}$ as Y_1 and then set Y_2 to be the first derivative of Y_1 and then set Y_3 to be the first derivative of Y_2 [which then becomes the second derivative of Y_1]. Once that is done, we use the solve function as shown.

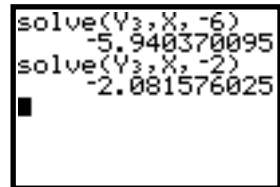
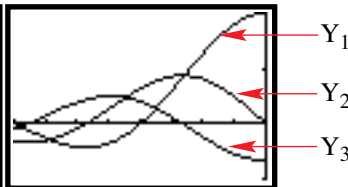
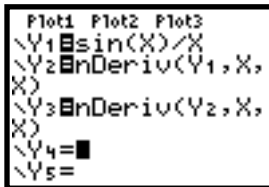

EXAMPLE 20.30

Determine the coordinates of all stationary points and their nature for the function with equation $f(x) = x^2e^{-x}$

S
O
L
I
T
I
O
N

First we differentiate the function $f(x) = x^2e^{-x}$: $f'(x) = 2xe^{-x} - x^2e^{-x} = xe^{-x}(2 - x)$. Stationary points occur where $f'(x) = 0 \Rightarrow xe^{-x}(2 - x) = 0 \Leftrightarrow x = 0$ or $x = 2$. Next we find the second derivative:

$$\begin{aligned} f''(x) &= (e^{-x} - xe^{-x}) \times (2 - x) + xe^{-x} \times -1 \\ &= e^{-x}((1 - x)(2 - x) - x) \\ &= e^{-x}(x^2 - 4x + 2) \end{aligned}$$

We can now check for the nature of the stationary points:

At $x = 0$, $f''(0) = e^{-0}(0^2 - 4 \times 0 + 2) = 2 > 0$. Implying a local minimum at $x = 0$.

At $x = 2$, $f''(2) = e^{-2}(2^2 - 4 \times 2 + 2) = -2e^{-2} < 0$. Implying a local maximum at $x = 2$.

Therefore, we have a local minimum at $(0, 0)$ and a local maximum at $(2, 4e^{-2})$.

EXERCISES 20.3

1. Use the second derivative to determine the nature of the stationary points of:

- (a) $f(x) = x^3 - 16x$ (b) $f(x) = x^4 - 2x^2$
 (c) $f(x) = \sqrt{x} - x$ (d) $y = xe^{-x}$
 (e) $y = (x + 1)\log_e x$ (f) $y = x^2(x - 1)^2$
 (g) $y = \frac{x}{x^2 + 1}$ (h) $y = \frac{x}{x^2 - 1}$

2. Find the maximum and minimum values of the following:

- (a) $f(x) = x^3 - 16x, 0 \leq x \leq 6$
 (b) $f(x) = x^4 - 2x^2, -2 \leq x \leq 4$
 (c) $y = \frac{x}{x^2 + 1}, 0 \leq x \leq 4$
 (d) $y = \sqrt[3]{(x - 1)^2}, 0 \leq x \leq 2$

3. Sketch the graph of $f(x) = \cos x + \frac{1}{2}\cos 2x, x \in [0, 2\pi]$ identifying all important features, including maximum, minimum and inflection points.

4. Sketch the graph of $f(x) = \sin x + \frac{1}{2}\sin 2x, x \in [0, 2\pi]$ identifying all important features, including maximum, minimum and inflection points.

5. Sketch the graph of $f(x) = x \sin x, x \in [-2\pi, 2\pi]$ identifying all important features, including maximum, minimum and inflection points.

6. Identify and justify the occurrence of all maximum points, minimum points and points of inflection for the curves with equation

- (a) $y = \sqrt{x} + \frac{1}{\sqrt{x}}$ (b) $y = \frac{x^2 + 3}{x + 1}$ (c) $y = \frac{\sqrt{x}}{x - 1}$

7. Sketch the graph of $f(x) = \sin^2 x - \cos x, x \in [0, 2\pi]$ identifying all important features, including maximum and minimum points.

8. Sketch the graph of

- (a) $f(x) = x^2 e^{-x}$
 (b) $f(x) = e^{4 - x^2}$
 (c) $g(x) = \frac{1}{x} e^{-\frac{1}{2}x}$

identifying all important features, including maximum, minimum and inflection points.

9. Sketch the graph of (a) $f(x) = \frac{1}{x} \ln(x)$ (b) $f(x) = x^2 - \ln x$

(c) $g(x) = \frac{2}{x} + \ln x$ (d) $h(x) = \ln[x(x-1)]$

identifying all important features, including maximum, minimum and inflection points.

10. Sketch the graph of the curve with equation $y = 2 \sec \theta - \tan \theta$, $0 \leq \theta < \frac{\pi}{2}$ identifying all

important features. Hence show that for $\theta \in \left[0, \frac{\pi}{2}\right]$ $2 \sec \theta - \tan \theta \geq \sqrt{3}$.

11. Consider the function $f(x) = (x-2)^a(x+2)^b$ where a and b are integers.

(a) Find $f'(x)$.

(b) Sketch the graph of $f(x)$, identifying all stationary points, for the case where

i. $a = 1, b = -1$

ii. $a = 2, b = 1$

iii. $a = 2, b = 2$

12. (a) Show that a critical value, c , of the function $f(x) = 5^x + \frac{1}{x}$ satisfies the equation

$$c^2 \ln 5 = 5^{-c}.$$

(b) Using the second derivative, identify the nature of the critical point where $x = c$.

(c) Sketch the graph of the function $f(x) = 5^x + \frac{1}{x}$, $x \neq 0$.

13. (a) For what values of c will $x \ln x - x + c \geq 1$, $x > 0$.

(b) Sketch the graph of the curve whose equation is $y = x \ln x - x + 2c$, $x > 0$, where c is the smallest value determined in part (a).

14. Making use of the second derivative, find the nature of

(a) all stationary points

(b) all points of inflection

of the curve with equation $y = x^2 \ln\left(\frac{1}{x^3}\right)$, $x > 0$.

(c) Sketch the graph of this curve.

15. For the function $f(x) = \frac{1}{x^2} \ln(x)$, $x > 0$ determine, where they exist, the coordinates of

(a) stationary points

(b) inflection points

(c) Sketch the graph of $f(x)$.

20.4 RATIONAL FUNCTIONS

20.4.1 SKETCHING THE GRAPH OF $x \mapsto \frac{ax+b}{cx+d}, cx+d \neq 0$

Properties

Graphs of this nature possess two types of asymptotes, one vertical and the other horizontal.

1. The vertical asymptote

A vertical asymptote occurs when the denominator is zero, that is, where $cx + d = 0$. Where this occurs, we place a vertical line (usually dashed), indicating that the curve cannot cross this line under any circumstances. This must be the case, because the function is undefined for that value of x .

For example, the function $x \mapsto \frac{3x+1}{2x+4}$ is undefined for that value of x where $2x + 4 = 0$. That is, the function is undefined for $x = -2$. This means that we would need to draw a vertical asymptote at $x = -2$. In this case, we say that the asymptote is defined by the equation $x = -2$. Using limiting arguments provides a more formal approach to ‘deriving’ the equation of the vertical asymptote. The argument is based along the following lines:

as $x \rightarrow -2^-$, $\frac{3x+1}{2x+4} \rightarrow +\infty$

That is, as x tends to -2 from the left or ‘below’, (hence the minus sign next to the two) the function tends to positive infinity.

as $x \rightarrow -2^+$, $\frac{3x+1}{2x+4} \rightarrow -\infty$

That is, as x tends to -2 from the right or ‘above’, (hence the plus sign next to the two) the function tends to negative infinity.

Therefore we write

$$\left. \begin{array}{l} \text{As } x \rightarrow -2^+ \quad f(x) \rightarrow -\infty \\ \text{As } x \rightarrow -2^- \quad f(x) \rightarrow +\infty \end{array} \right\} \therefore x = -2 \text{ is a vertical asymptote of } f(x) = \frac{3x+1}{2x+4}, x \neq -2.$$

2. The horizontal asymptote

To determine the equation of the horizontal asymptote, again we use a limiting argument, however, this time we observe the behaviour of the function as $x \rightarrow \pm\infty$.

It will be easier to determine the behaviour of the function (as $x \rightarrow \pm\infty$) if we first ‘simplify’ the

rational function (using long division): $f(x) = \frac{3x+1}{2x+4} = \frac{3}{2} - \frac{5}{2x+4}$.

Next we determine the behaviour for extreme values of x :

$$\left. \begin{array}{l} \text{As } x \rightarrow +\infty \quad f(x) \rightarrow \left(\frac{3}{2}\right)^- \\ \text{As } x \rightarrow -\infty \quad f(x) \rightarrow \left(\frac{3}{2}\right)^+ \end{array} \right\} \text{Therefore, } y = \frac{3}{2} \text{ is the horizontal asymptote}$$

We can now add a few more features of the function:

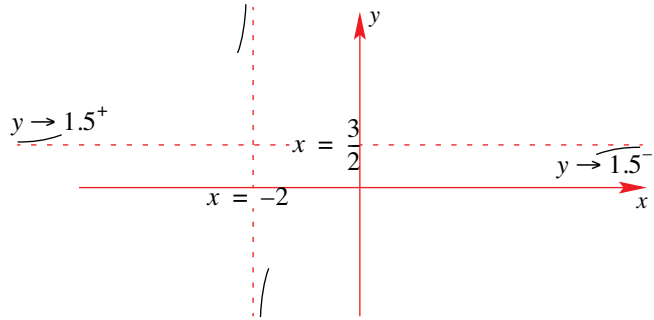

3. Axial intercepts

x-intercept

To determine the x -intercept(s) we need to solve for $f(x) = 0$.

$$\text{In this case we have } f(x) = \frac{3x+1}{2x+4} = 0 \Leftrightarrow 3x+1 = 0 \Leftrightarrow x = -\frac{1}{3}.$$

That is, the curve passes through the point $\left(-\frac{1}{3}, 0\right)$.

y-intercept

To determine the y -intercept we find the value of $f(0)$ (if it exists, for it could be that the line $x = 0$ is a vertical asymptote).

$$\text{In this case we have } f(0) = \frac{3 \times 0 + 1}{2 \times 0 + 4} = \frac{1}{4}.$$

Therefore the curve passes through the point $\left(0, \frac{1}{4}\right)$.

Having determined the behaviour of the curve near its asymptotes (i.e., if the curve approached the asymptotes from above or below) and the axial-intercept, all that remains is to find the stationary points (if any).

4. Stationary points

To determine the coordinates of stationary points we need to first solve for $f'(x) = 0$ and then (if we do have a solution) substitute into the equation of $f(x)$ so that we can obtain the y coordinate.

$$\text{In this case we have (using the quotient rule): } f'(x) = \frac{3(2x+4) - 2(3x+1)}{(2x+4)^2} = \frac{10}{(2x+4)^2}.$$

Therefore, $f'(x) = 0 \Leftrightarrow \frac{10}{(2x+4)^2} = 0$, for which there are no real solutions.

MATHEMATICS – Higher Level (Core)

This means that there are no stationary points for this curve. In fact, it can be shown that any function of the form $f(x) = \frac{ax+b}{cx+d}$ will never have a stationary point. We leave this as an exercise for you! We are now in a position to complete the sketch of our function. The information we have is

1. Asymptotes

$$x = -2.$$

$$y = \frac{3}{2}.$$

2. Intercepts

$$x - \left(-\frac{1}{3}, 0\right).$$

$$y - \left(0, \frac{1}{4}\right).$$

3. Stationary points

None.

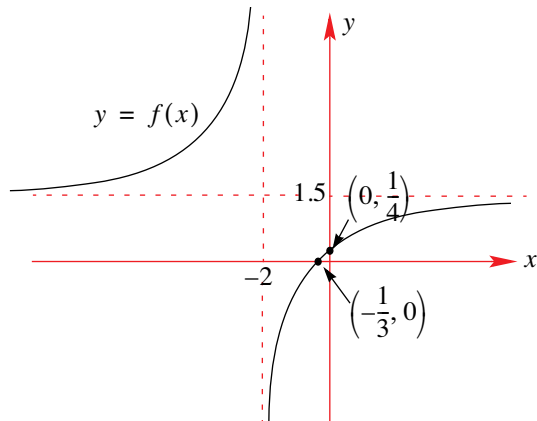

20.4.2 OTHER RATIONAL FUNCTIONS

EXAMPLE 20.31

Sketch the graph of $f(x) = 2 + \frac{x}{x^2 - 1}$, $x \neq \pm 1$.

S
o
l
u
t
i
o
n

The most obvious thing to do is— use your graphics calculator:



However, this only gives a general idea of the shape of the function, we still want to study some of its properties in more detail. We begin by investigating its asymptotic properties:

First we rewrite the function $f(x) = 2 + \frac{x}{x^2 - 1}$ as $f(x) = 2 + \frac{x}{(x-1)(x+1)}$. This will enable us to concentrate on x -values that will help us determine the asymptotes

Vertical Asymptotes:

These will correspond to values of x for which the denominator is zero.

That is, those values of x for which $(x-1)(x+1) = 0$, i.e., where $x = 1$ and $x = -1$.

Case 1 $x = 1$: As $x \rightarrow 1^+$ then $f(x) \rightarrow +\infty$
and as $x \rightarrow 1^-$ then $f(x) \rightarrow -\infty$.

Case 2 $x = -1$: As $x \rightarrow -1^+$ then $f(x) \rightarrow +\infty$
and as $x \rightarrow -1^-$ then $f(x) \rightarrow -\infty$.

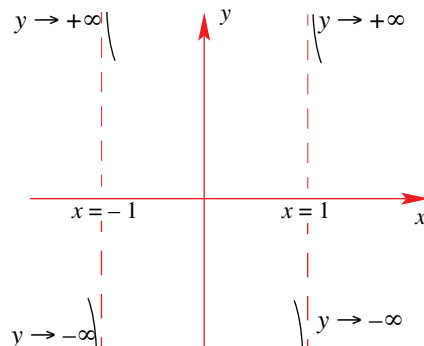

Horizontal asymptote:

That is, we look at the behaviour of $f(x)$ as $|x| \rightarrow \infty$

As $x \rightarrow +\infty$ then $\frac{x}{x^2-1} \rightarrow 0^+ \therefore f(x) \rightarrow 2^+$.

As $x \rightarrow -\infty$ then $\frac{x}{x^2-1} \rightarrow 0^- \therefore f(x) \rightarrow 2^-$.

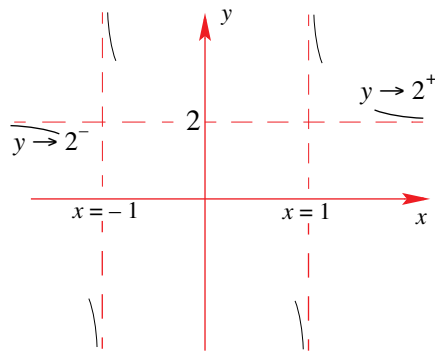

We now determine the intercepts with the axes.

x-intercept(s):

$$\begin{aligned} \text{Setting } f(x) = 0, \text{ we have, } 2 + \frac{x}{x^2-1} = 0 &\Leftrightarrow \frac{x}{x^2-1} = -2 \Leftrightarrow x = -2x^2 + 2 \\ &\Leftrightarrow 0 = 2x^2 + x - 2 \\ &\Leftrightarrow x = \frac{-1 \pm \sqrt{17}}{4} \end{aligned}$$

That is, the curve crosses the x -axis at $\left(\frac{-1 + \sqrt{17}}{4}, 0\right)$ and $\left(\frac{-1 - \sqrt{17}}{4}, 0\right)$.

y-intercept:

We evaluate $f(0) = 2 + \frac{0}{0-1} = 2$. That is the curve passes through the point $(0, 2)$.

Notice that we have in fact cut the horizontal asymptote at $(0, 2)$!

We can also look for possible stationary points and points of inflexion.

Stationary points:

We need to solve for $f'(x) = 0$.

$$\text{Now } f(x) = 2 + \frac{x}{x^2-1} \Rightarrow f'(x) = \frac{1 \times (x^2-1) - x \times 2x}{(x^2-1)^2} = \frac{-(x^2+1)}{(x^2-1)^2}.$$

Therefore, setting $\frac{-(x^2+1)}{(x^2-1)^2} = 0 \Rightarrow -(x^2+1) = 0$. For which there are no real solutions.

Therefore, there are no stationary points on this graph.

Points of inflection:

We first find the second derivative:

$$\begin{aligned} \text{Now, } f'(x) = \frac{-(x^2+1)}{(x^2-1)^2} &\Rightarrow f''(x) = \frac{-2x(x^2-1)^2 - (x^2+1)(2 \cdot 2x \cdot (x^2-1))}{(x^2-1)^4} \\ &= \frac{2x(x-1)(x^2+3)}{(x^2-1)^4} \quad (\text{After some simplification}). \end{aligned}$$

$$\text{Therefore, setting } f''(x) = 0 \Rightarrow \frac{2x(x-1)(x^2+3)}{(x^2-1)^4} = 0 \Leftrightarrow x = 0, \pm 1.$$

But, $x \neq \pm 1$, therefore the only solution is $x = 0$. To check if in fact there is a point of inflection we need to check the sign of $f'(x)$ or $f''(x)$ on either side of $x = 0$.

MATHEMATICS – Higher Level (Core)

We now show how this can be done using the TI-83. That is we sketch the graph of $y = f'(x)$.

```

Plot1 Plot2 Plot3
Y1=-(X^2+1)/(X^2
-1)2)
Y2=
Y3=
Y4=
Y5=
Y6=
    
```

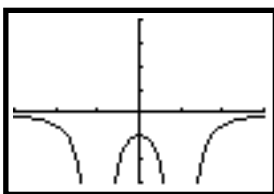

From the graph of $y = f'(x)$ we see that $f'(x) < 0$ for all values of x .

In particular, $f'(x) < 0$ for $x > 0$ and $f'(x) < 0$ for $x < 0$

Therefore, at $x = 0$, i.e., at $(0, 2)$ we have a non-stationary point of inflection.

Note that we could have sketched the graph of the second derivative using the TI-83 to verify this:

```

Plot1 Plot2 Plot3
Y1=-(X^2+1)/(X^2
-1)2)
Y2=2nDeriv(Y1,X,
X)
Y3=
Y4=
Y5=
    
```

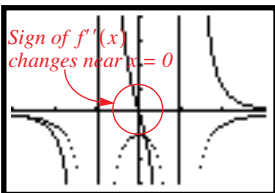

From this graph, we see that the sign of the second derivative changes from positive to negative as x increases near $x = 0$.

That is $f''(x) > 0$ just before $x = 0$ and $f''(x) < 0$ just after $x = 0$.

After all this, we can now sketch the graph of $f(x) = 2 + \frac{x}{x^2 - 1}$.

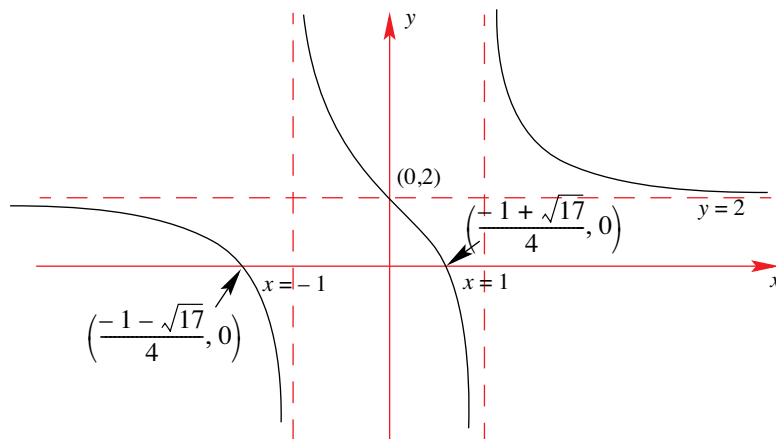

It should be noted that functions other than rational functions also have asymptotes. For example, graphs having the equation $f(x) = a + be^{kx}$ have a horizontal axis at $y = a$, and graphs whose equation is given by $f(x) = a \log_e(x - k) + c$ have a vertical asymptote at $x = k$. These functions have been dealt with in Chapter 7.

20.4.3 OBLIQUE AND CURVED ASYMPTOTES

So far we have only looked at vertical and horizontal asymptotes. However, there are other types of asymptotes. These are

1. **oblique asymptotes** (also known as sloping asymptotes) and
2. **curved asymptotes.**

An oblique asymptote is a straight line that is neither vertical nor horizontal. Unlike the vertical asymptote, which can never be cut by the curve, an oblique asymptote can be cut by the curve.

Curved asymptotes, as its name suggests, are just that – curved. We look at how these asymptotes come about when sketching curves that possess them.

Consider the function $f(x) = x + \frac{1}{x}, x \neq 0$.

As x becomes a very large positive number, the term $\frac{1}{x}$ will diminish to an insignificant positive number. That is, as $x \rightarrow +\infty, \frac{1}{x} \rightarrow 0^+$. Meaning that $f(x)$ will only be left with the x term.

We can write this as follows: As $x \rightarrow +\infty, f(x) \rightarrow x + 0^+$, or, as $x \rightarrow +\infty, f(x) \rightarrow x^+$.

This means that as $x \rightarrow +\infty$, the function $f(x)$ will **approach** the line $y = x$ **from above**.

Similarly:

As $x \rightarrow -\infty$ then $\frac{1}{x} \rightarrow 0^-$ so that as $x \rightarrow -\infty, f(x) \rightarrow x + 0^-$, or, as $x \rightarrow -\infty, f(x) \rightarrow x^-$.

This means that as $x \rightarrow -\infty$, the function $f(x)$ will **approach** the line $y = x$ **from below**.

We also know that there is a vertical asymptote at $x = 0$, and that as $x \rightarrow 0^+, f(x) \rightarrow +\infty$

and as $x \rightarrow 0^-, f(x) \rightarrow -\infty$

We can now start to sketch the graph:

Step 1: Draw the oblique asymptote and pencil in the behaviour of $f(x)$ as $x \rightarrow \pm\infty$ and $x \rightarrow 0^\pm$

Step 2: Determine all other information, i.e., intercepts, stationary points etc. Then complete the sketch:

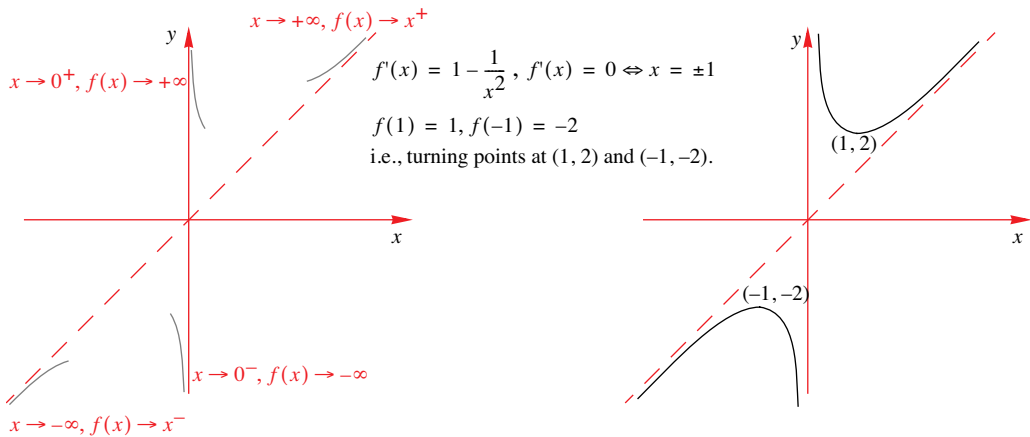

The same could be done with the function $f(x) = x + \frac{1}{x^2}$:

As $x \rightarrow +\infty, f(x) \rightarrow x^+$ and as $x \rightarrow -\infty, f(x) \rightarrow x^+$ (note that $f(x) \rightarrow x^+$ for both $x \rightarrow \pm\infty$).

Also, as $x \rightarrow 0^+, f(x) \rightarrow +\infty$ and as $x \rightarrow 0^-, f(x) \rightarrow +\infty$.

Next, we determine the stationary points: $f'(x) = 1 - \frac{1}{x^3} = 0 \Leftrightarrow x = 1$.

Then, when $x = 1, f(1) = 1 + 1 = 2$. That is there is a stationary point at $(1, 2)$ [which can be verified to be a local minimum].

Intercepts occur when $f(x) = 0 \Leftrightarrow x = -1$, i.e., curve passes through $(-1, 0)$.

Also, $x = 0$ corresponds to a vertical asymptote. We are now in a position to first pencil in our findings and then complete the sketch:

MATHEMATICS – Higher Level (Core)

pencil in information:

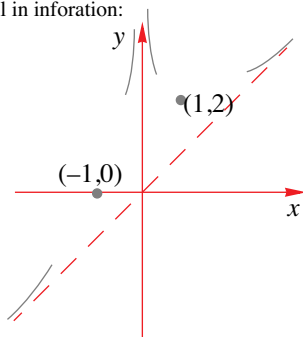

complete sketch:

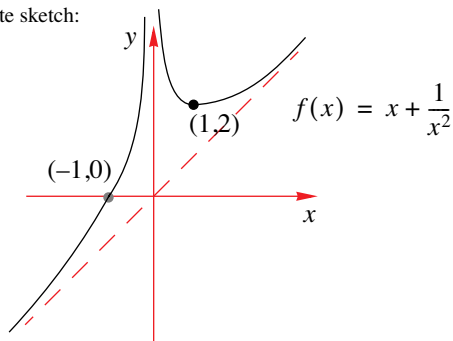

What if the function had been $f(x) = 4x^2 + \frac{1}{x}$?

Proceeding in the same way we have:

As $x \rightarrow +\infty, \frac{1}{x} \rightarrow 0^+ \therefore f(x) \rightarrow (4x^2)^+$ [i.e., $f(x)$ approaches the **curve** $y = 4x^2$ from above]

As $x \rightarrow -\infty, \frac{1}{x} \rightarrow 0^- \therefore f(x) \rightarrow (4x^2)^-$ [i.e., $f(x)$ approaches the **curve** $y = 4x^2$ from below]

The vertical asymptote is given by $x = 0$.

To find the x -intercept(s), set $f(x) = 0$, giving $x = -1$.

For stationary points, $f'(x) = 8x - \frac{1}{x^2} = 0 \Leftrightarrow x = \frac{1}{2}$. Giving a local min at $(\frac{1}{2}, 3)$.

Again, we use our two steps process, first pencil in the information and then complete the sketch.

pencil in information:

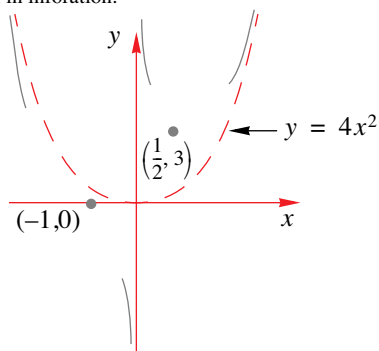

complete sketch:

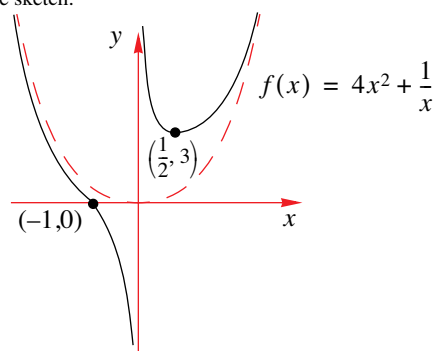

Summary:

Functions having the basic form $f(x) = ax^m + \frac{b}{x^n} + c$, where m and n are positive

integers have a vertical asymptote at $x = 0$ and an asymptote $y = ax^m + c$, which is

1. oblique if $m = 1, a \neq 0$ [i.e., straight line asymptote, $y = ax + c$].
2. curved if $m > 1, a \neq 0$ [e.g., $y = ax^2 + c$ has a parabolic asymptote].
3. horizontal if $a = 0$ [i.e., $y = c$].

The basic form of $f(x)$ can be easily extended, e.g., the function $f(x) = x - 2 + \frac{3}{x+1}$ would possess a vertical asymptote at $x = -1$ and an oblique asymptote, $y = x - 2$.

MATHEMATICS – Higher Level (Core)

- 7.** (a) Express $\frac{8x-5}{x-3}$ in the form $A + \frac{B}{x-3}$, where A and B are integers.

Hence, state the equations of the vertical and horizontal asymptotes of the function

$$f(x) = \frac{8x-5}{x-3}.$$

- (b) Sketch the graph of $f(x) = \frac{8x-5}{x-3}$ and use it to determine its range.

- 8.** On different sets of axes, sketch the graphs of $f(x) = 2 + \frac{1}{x}$ and $g(x) = \frac{1}{f(x)}$, stating their domains and ranges.

- 9.** Sketch the graph of the following functions, clearly labelling all asymptotes.

(a) $f(x) = 2x + \frac{1}{x}, x \neq 0$

(b) $g(x) = \frac{1}{2}x + \frac{1}{x^2}, x \neq 0$

(c) $g(x) = -x + \frac{1}{x}, x \neq 0$

(d) $f(x) = x - \frac{1}{x}, x \neq 0$

- 10.** Sketch the graph of the following functions, clearly labelling all asymptotes.

(a) $h(x) = x^2 + \frac{2}{x}, x \neq 0$

(b) $f(x) = x^2 + \frac{1}{x^2}, x \neq 0$

(c) $g(x) = x - \frac{1}{x^2}, x \neq 0$

(d) $f(x) = x^3 + \frac{3}{x}, x \neq 0$

- 11.** Sketch the graph of the following functions, clearly labelling all asymptotes.

(a) $f(x) = x + 3 + \frac{2}{x}, x \neq 0$

(b) $f(x) = -x + \frac{1}{x} + 2, x \neq 0$

(c) $g(x) = 2x + \frac{1}{x^2} - 2, x \neq 0$

(d) $f(x) = \frac{x^2 + 2x - 2}{x}, x \neq 0$

- 12.** (a) For the function $f(x) = 3 + \frac{1}{1-x} - x$

i. determine all axial intercepts and the coordinates of its stationary points.

ii. write down the equation of all the asymptotes.

- (b) Sketch the graph of $y = f(x)$ clearly labelling all the information from part (a).

- 13.** Sketch the graphs of i. $f(x) = \frac{x^2 - x - 1}{x - 2}, x \neq 2$.

ii. $g(x) = \frac{(x+2)^2(x-1)}{x^2}, x \neq 0$.

- 14.** Sketch the graphs of the following functions:

(a) $f(x) = \frac{2x-3}{x^2-3x+2}$

(b) $y = \frac{x^2+2x}{x^2+4}$

(c) $y = \frac{x^4+1}{x^2+1}$

- 15.** Sketch the graph of $f(x) = \frac{x+1}{\sqrt{x-1}}$, clearly identifying all asymptotes and turning points.

21.1 RATES OF CHANGE

21.1.1 DEFINITIONS

We saw in Chapter 18 that $\frac{dy}{dx}$ measures the **rate of change of a quantity y with respect to another quantity x** . In the same way, we have that

$\frac{dA}{dr}$ measures the rate of change of A with respect to r ,

$\frac{dV}{dt}$ measures the rate of change of V with respect to t and

$\frac{dP}{dV}$ measures the rate of change of P with respect to V .

For example, if $A \text{ m}^2$ measures the area of a circle of radius $r \text{ m}$, then $\frac{dA}{dr}$ (or $A'(r)$) measures the rate of change of the area A with respect to its radius r . Then, as $A = \pi r^2 \Rightarrow \frac{dA}{dr} = 2\pi r$.

We note that a rate of change statement needs to have two quantities specified:

1. what quantity is changing, and
2. what it is changing with respect to.

However, often we use the expression ‘*the rate of change of ...*’ with no reference to a second quantity. In such cases it can be assumed that we are referring to **the rate of change with respect to time**. So that “The rate of change of N ”, where N measures the population size of a herd of elephants, would be given by $\frac{dN}{dt}$, where t represents a unit of time.

EXAMPLE 21.1

Find the rate of change of the volume of a sphere with respect to its radius.

S
o
i
u
t
i
o
n

If we consider a sphere as having a volume $V \text{ units}^3$ for a corresponding radius $r \text{ units}$, then we are looking for the expression $\frac{dV}{dr}$.

In order to determine this rate we need to have V as an expression in terms of r .

The volume of a sphere of radius r is given by $V = \frac{4}{3}\pi r^3$.

And so, we have that $\frac{dV}{dr} = \frac{4}{3}\pi \times 3r^2 = 4\pi r^2$.

Notice that a sphere of radius r has a surface area given by $S = 4\pi r^2$ and so, we have that $\frac{dV}{dr} = S$. That is, the rate of change of the volume of a sphere with respect to its radius is equal to its surface area! Are there other shapes for which this result is true?

21.1.2 RATES OF CHANGE AND THEIR SIGN

The following information relates to a quantity y as it varies with respect to the quantity x .

If we have a positive rate over some interval (a, b) then y **increases** over the interval (a, b) .

i.e., if $\frac{dy}{dx} > 0$ on the interval (a, b) , then the values of y **increase** as the values of x increase on the interval (a, b) .

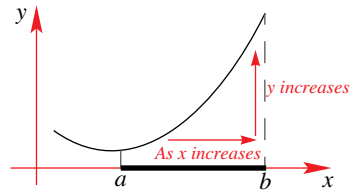

If we have a negative rate over some interval (a, b) then y **decreases** over the interval (a, b) .

i.e., if $\frac{dy}{dx} < 0$ on the interval (a, b) , then the values of y **decrease** as the values of x increase on the interval (a, b) .

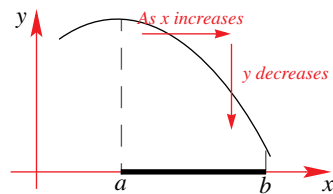

If we have a zero rate over some interval (a, b) , then y **is constant** over the interval (a, b) .

i.e., if $\frac{dy}{dx} = 0$ on the interval (a, b) , then the values of y **remain constant** for all values of x on the interval (a, b) .

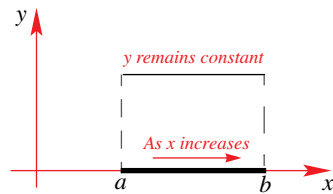

EXERCISES 21.1

1. Identify on the following graphs the values of x for which the function is
- | | | |
|---------------|----------------|---------------|
| i. increasing | ii. decreasing | iii. constant |
| (a) | (b) | (c) |

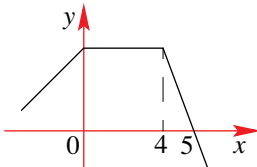

(d)

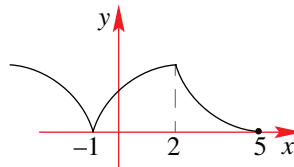

(e)

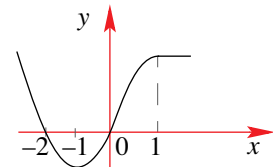

(f)

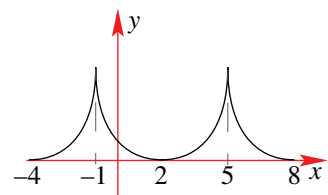
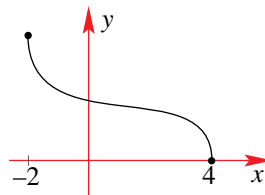
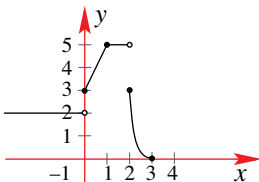

21.2 APPLIED RATES OF CHANGE

Applications of rates of change can be found in many situations. In this section we make use of a number of examples to highlight the diversity for which rates of change are useful.

EXAMPLE 21.2

The number, $N(t)$, of bacteria in a colony is given by the function

$$t \mapsto 1.25t^2 + 20t + 980, t \geq 0, \text{ where } t \text{ is measured in hours.}$$

- Find the rate of growth of the colony when $t = 4$.
- Show that $N(t)$ is an increasing function.

Solution

- Let $N(t) = 1.25t^2 + 20t + 980, t \geq 0$. The rate of growth is given by $\frac{dN}{dt}$ or $N'(t)$,

and so, $N'(t) = 2.5t + 20$. Then, when $t = 4$, $N'(4) = 2.5 \times 4 + 20 = 30$.

That is, the colony is growing at a rate of 30 bacteria per hour (when $t = 4$).

- To show that $N(t)$ is an increasing function, we need to show that its derivative is positive over its given domain. That is, we need to show that $N'(t) > 0$ (for $t \geq 0$).

Now, $N'(t) = 2.5t + 20$,

so that for $t \geq 0$, $N'(t) \geq 20$.

Therefore we have that

$$N'(t) > 0 \text{ for } t \geq 0,$$

$\therefore N(t)$ is an increasing function.

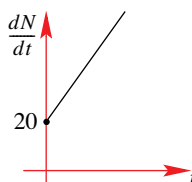

Graphical approach:

The graph of $N'(t)$ shows that

$N'(t) > 0$ for $t \geq 0$, and so,

$N(t)$ is an increasing function

(for $t \geq 0$).

EXAMPLE 21.3

The population size of mosquitoes in a controlled laboratory experiment is modelled by the equation $P(t) = 250e^{0.09t}, t \geq 0$, where t is measured in days. Find the growth rate of the mosquito population after 5 days.

Solution

The rate of change of P with respect to t is given by $\frac{dP}{dt} = 250 \times 0.09e^{0.09t} = 22.5e^{0.09t}$

Therefore, when $t = 5$, $\frac{dP}{dt} = 22.5e^{0.09 \times 5} = 35.2870$.

That is, after five days, the number of mosquitoes is **increasing** at a rate of 35.29 mosquitoes per day (or 35 to the nearest whole number).

EXAMPLE 21.4

A hot metal bar is placed in an environment where the temperature remains constant at 34°C . The temperature of the metal bar, $T^\circ\text{C}$, is modelled by the equation

$$T = 34 + 90e^{-0.2t}, t \geq 0,$$

where t is measured in minutes.

Find the rate of change of the temperature of the bar 10 minutes after it is placed in this environment.

S Given that $T = 34 + 90e^{-0.2t}$ then $\frac{dT}{dt} = 90 \times -0.2e^{-0.2t}$
 $= -18.0e^{-0.2t}$.

i Therefore, when $t = 10$, we have $\frac{dT}{dt} = -18e^{-2} \approx -2.436$.

t That is, the rate of change of temperature is approximately -2.44°C per minute.

n This means that the temperature is **decreasing** at a rate of 2.44°C per minute.

EXAMPLE 21.5

The concentration, C mol/litre, of a drug in the blood t minutes after being administered is given by the equation

$$C = bt2^{-kt}, 0 \leq t \leq 30.$$

How long will it be before the concentration level in the blood starts to decrease?

S We need to determine $\frac{dC}{dt}$. Now, $C = bt2^{-kt}, 0 \leq t \leq 30$

i $\therefore \frac{dC}{dt} = \frac{d}{dt}(bt2^{-kt}) = b\left[\frac{d}{dt}(t) \times 2^{-kt} + t \times \frac{d}{dt}(2^{-kt})\right]$ [product rule]
 $= b[2^{-kt} + t \times -k(\ln 2)2^{-kt}]$
 $= b[1 - k(\ln 2)t]2^{-kt}$

t Then, $\frac{dC}{dt} = 0$ when $b[1 - k(\ln 2)t]2^{-kt} = 0 \Leftrightarrow [1 - k(\ln 2)t] = 0 \Leftrightarrow t = \frac{1}{k(\ln 2)}$.

Up until that time, the concentration of the drug in the blood is increasing and after that time the concentration of the drug in the blood is decreasing. A graph of this scenario best displays this.

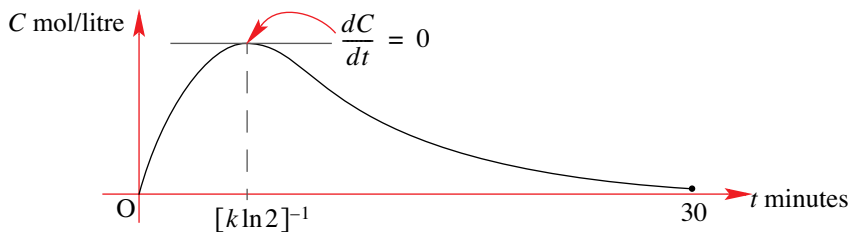

Application to economics

There are three important functions used in the area of manufacturing a commodity:

- 1.** The **Cost** function, $C(x)$
- 2.** The **Revenue** function, $R(x)$
- 3.** The **Profit** function, $P(x)$,

where x is the number of items produced.

The rates of change with respect to x for each of these functions, $\frac{dC}{dx}$, $\frac{dR}{dx}$ and $\frac{dP}{dx}$ are referred to as the **Marginal Cost**, the **Marginal Revenue** and the **Marginal Profit** respectively.

EXAMPLE 21.6

The cost in dollars of manufacturing x units of a product is given by

$$C(x) = x^3 - 20x^2 + 300x + 1000, x \geq 0.$$

If each item sells for \$300, find the marginal profit when 100 units are being manufactured.

S
o
l
u
t
i
o
n

First we need the profit equation:

Profit = Revenue – Cost,

$$P(x) = R(x) - C(x)$$

where the revenue, $R(x) = 300x$ (as each item sells for \$300).

Therefore we have

$$\begin{aligned} P(x) &= 300x - (x^3 - 20x^2 + 300x + 1000) \\ &= -x^3 + 20x^2 - 1000 \end{aligned}$$

So the marginal profit,

$$\frac{dP}{dx} = -3x^2 + 40x.$$

Then, for $x = 100$, we have that

$$\begin{aligned} \frac{dP}{dx} &= -3(100)^2 + 40(100) \\ &= -26,000. \end{aligned}$$

Application to kinematics

One important case of problems involving rates of change is kinematics. That is, the area concerned with the properties of motion, usually that of particles (or point masses). At this stage we will only provide two initial definitions and will leave a more detailed study of this topic until the next section.

Consider a particle having a **displacement**, $x(t)$ from a fixed point O at time t , then

its **instantaneous velocity**,

$$v(t) = \frac{dx}{dt} = x'(t) \text{ and}$$

its **instantaneous acceleration**,

$$a(t) = \frac{dv}{dt} = x''(t)$$

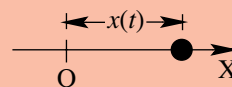

EXAMPLE 21.7

A body moves along the x -axis with displacement x cm where

$x(t) = 10(t - \ln(t + 1))$, $t \geq 0$ and t is the time in seconds. Find the object's velocity and acceleration after being in motion for 1 second.

S
o
l
u
t
i
o
n

Using our definitions we have, $v(t) = \frac{dx}{dt} = 10\left(1 - \frac{1}{t+1}\right) \therefore v(1) = 10\left(1 - \frac{1}{2}\right) = 5$

The acceleration is given by $a = v'(t) = \frac{10}{(t+1)^2} \therefore a(1) = \frac{10}{4} = 2.5$

i.e., the object has a velocity of 5 m/s and an acceleration of 2.5 m/s² after 1 second.

EXERCISES 21.2

- 1.** The number of deer, N , involved in a breeding program set up in a reserve has been modelled by the function $N = \frac{1}{10}t^2 + 4t + 50$, where t is measured in years since the program started. Find the rate at which the deer population is increasing 2 years after the program started.

- 2.** The volume, $V \text{ cm}^3$, of an object is given by the relation

$$V(t) = 0.5t^3 - 18t^2 + 216t + 200, t \geq 0,$$

where t is measured in days.

- (a) Find the initial volume of the object.
 (b) Find the rate of change of the volume when $t = 5$.
- 3.** The number of organisms, N , present in a culture of bacteria, t hours from when observations were first made, is given by $N(t) = 3t^2 + 15t + 800, t \geq 0$.
- (a) Find the rate of change of the number of organisms after 10 hours.
 (b) Show that the number of organisms will always increase. Is this a realistic model?

- 4.** The installation of a new electrical component into an existing product on an assembly line has an associated cost (per component), C dollars, that is closely approximated by the function

$$C = 8^3 \sqrt{(1.5t + 11.5)^4}, 0 \leq t \leq 7,$$

where t is measured in years.

- (a) What will the initial cost per component be?
 (b) Find the average rate at which the cost per component is changing over the first seven years.
 (c) Find the rate of change in cost per component after 4 years of operation.
- 5.** The number of sales, N thousand, made by a company is related to its advertising cost, x thousand dollars, by the equation

$$N = \frac{x^2}{9000}(300 - x), 0 \leq x \leq 200.$$

Find the rate of change of the number of sales (*with respect to the advertising cost*)

- for (i) $x = 50$ (ii) $x = 100$ (iii) $x = 150$

- 6.** The profit P made by an entertainment centre when selling x bags of lollies was modelled by the equation

$$P = 2.5x - \frac{1}{20000}x^2 - 3000, 0 \leq x \leq 50000.$$

- (a) For what values of x is the centre making a positive profit?
 (b) For what values of x is the profit
 i. increasing?
 ii. decreasing?
- 7.** The revenue equation for a product is given by $R = 59xe^{-0.000015x}, x \geq 0$. Find the value of x for which its marginal revenue is zero. Hence, determine the maximum revenue.

- 8.** The production strategy of a company manufacturing electrical components is based on the following models;

Demand equation: $x = 12000 - 30p$

where x is the number of components retailers are likely to buy per month at $\$p$ per component.

Cost equation: $C(x) = 50000 + 20x$

- Show that the revenue equation, $R(x)$, is given by $x \mapsto x\left(400 - \frac{x}{30}\right)$.
- Find the marginal revenue for a production level of 4000 units.
- Show that the profit, $P(x)$, is given by $x \mapsto 380x - \frac{1}{30}x^2 - 50000$.
- Determine the marginal profit when 5000 units are produced.
- For what values of x is the profit increasing?

- 9.** Based on classical economic theory, the demand, $D(x)$, for a commodity in a free market decreases as the price x increases. The number of items, $D(x)$ of a particular product that people are willing to buy per week in a given town at a price $\$x$ is given

by the function
$$D(x) = \frac{40000}{x^2 + 12x + 20}, \quad 5 \leq x \leq 18.$$

- Find the rate of change of demand with respect to price change.
- Find the rate of change of demand with respect to price change for $x = 10$.

- 10.** During the early days of learning theory, a model to describe success based on the amount of practice undertaken by a person was given by

$$S(x) = 100\left(\frac{x+2}{x+32}\right)$$

where $S(x)$ measured the percentage of successful attempts after x practice attempts.

- Determine the rate at which learning occurs with respect to the percentage of practices undertaken.
- For what values of x is $S(x)$
 - increasing?
 - decreasing?

- 11.** The function $P(t) = 100 - 20 \cos\left(\frac{5\pi}{3}t\right)$ approximates the blood pressure

P millimetres of mercury at time t seconds for a person at rest.

- Find the rate of change in blood pressure when (i) $t = 0$ (ii) $t = \frac{1}{5}$
- Find the longest time period for which the blood pressure is increasing.

- 12.** A particle moves in such a way that its displacement, x cm, t seconds after starting to move from a fixed point O is given by

$$x(t) = 10t + 20e^{-0.2t}, \quad t \geq 0.$$

- Determine the rate of change of its displacement at time $t = 5$.
- Will this particle ever maintain a constant velocity for a period of time?
- Will this particle ever maintain a constant acceleration for a period of time?

- 13.** Find the acceleration of a particle at $t = 1$, if its displacement at time t is $x = t^2e^{-t}$, $t \geq 0$.

21.3 KINEMATICS

We have seen how rates can be used to define certain quantities, and briefly mentioned velocity and acceleration at the end of §21.2. We also saw in Chapter 18 how the average rate of change of displacement (with respect to time) provided a measure of the average velocity. In this section we provide a more in-depth study of kinematics. In particular, we concentrate on the relationship between displacement, velocity and acceleration.

21.3.1 MOTION ALONG A STRAIGHT LINE

We will be concentrating on motion along a straight line, where a body is free to move either forwards and backwards or up and down. When an object moves along a straight line OX, its position from a fixed point O, referred to as the origin, is determined by its displacement OP.

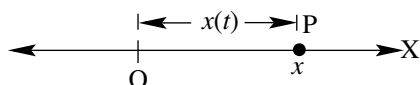

Usually the motion is along the x -axis and so its displacement is denoted by x , however, other representations, like s or h (usually for height) can be used. If the position of the body along the straight line can be specified at any instant, its displacement x can be written as a function of time, t units, so that $x = f(t)$ (or simply $x(t)$).

Representing a body's displacement–time relationship is often done by using a displacement–time graph. From such a graph, we can extend our initial definition of average velocity to that of instantaneous velocity:

average velocity

Average velocity, v_{ave} , is given by the gradient of the secant:

$$v_{ave} = \frac{\delta x}{\delta t} = \frac{x_2 - x_1}{t_2 - t_1}$$

instantaneous velocity

Instantaneous velocity, v , occurs when $t_2 \rightarrow t_1$. i.e., $\delta t \rightarrow 0$ and is given by the gradient of the tangent:

$$v = \lim_{\delta t \rightarrow 0} \frac{\delta x}{\delta t} = \frac{dx}{dt}$$

That is, the instantaneous velocity, v , at any time t is given by the first derivative of the displacement equation. Similarly, the average change in velocity gives the average acceleration,

i.e., $a_{ave} = \frac{v_2 - v_1}{t_2 - t_1} = \frac{\delta v}{\delta t}$. Then, as $t_2 \rightarrow t_1$, i.e., $\delta t \rightarrow 0$, we have $a = \lim_{\delta t \rightarrow 0} \frac{\delta v}{\delta t} = \frac{dv}{dt}$ which

gives the instantaneous acceleration at any time t . That is, the acceleration is given by the first derivative of the velocity or the second derivative of the displacement.

We must remember that we are considering **motion of a particle along a straight line**, even though the displacement-time graph is a two dimensional curve representing the motion. In short, the particle is **not** on what appears to be a ‘roller-coaster ride’ - it is always moving along a straight line. By projecting this curve onto the x -axis (as shown below on a parallel line) we can see where the particle is on this line at different times, which direction it is moving in, when and where its velocity is zero, and so on.

Projection of particle’s position onto the vertical straight line

We follow the particle as it moves from A to B to C to D to E and finally to F by projecting the corresponding points on the displacement-time curve onto the vertical axis.

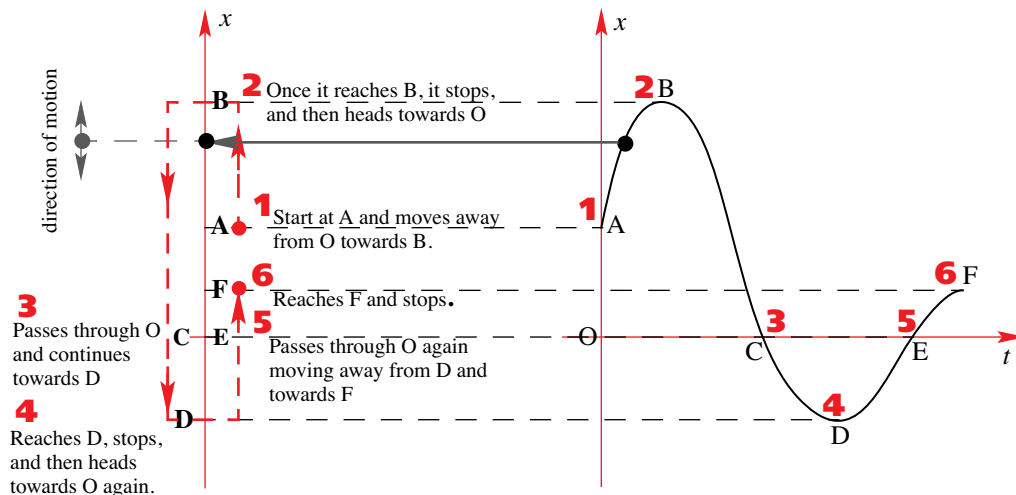

The relationships between displacement, velocity and acceleration are summarised as follows:

Velocity:

Velocity measures the rate of change of displacement.

So that if an object has a velocity v m/s and a displacement of x metres, then the relationship between v and x is given by

$$\frac{dx}{dt} = v$$

Acceleration:

Acceleration measures the rate of change of velocity.

So that if an object has an acceleration a m/s² and a velocity of v m/s, then the relationship between a and v is given by

$$\frac{dv}{dt} = a$$

Notice then that two other relationships can be derived:

1. From $a = \frac{dv}{dt}$, we have $a = \frac{dv}{dt} = \frac{d}{dt}(v) = \frac{d}{dt}\left(\frac{dx}{dt}\right) = \frac{d^2x}{dt^2}$.
2. From $a = \frac{dv}{dt}$, we have $a = \frac{dv}{dt} = \frac{dv dx}{dx dt} = v \frac{dv}{dx}$.

EXAMPLE 21.8

A particle is projected vertically upwards in such a way that it experiences resistance so that its height, x metres above the ground after time t seconds, is given by

$$x = 220(1 - e^{-0.2t}) - 20t, t \geq 0.$$

When will the particle reach its maximum height?

S
o
l
u
t
i
o
n

When the particle reaches its maximum height, it will momentarily stop, so that its velocity will

be zero. That is $\frac{dx}{dt} = 0$. So, $x = 220(1 - e^{-0.2t}) - 20t \Rightarrow \frac{dx}{dt} = 220(0.2e^{-0.2t}) - 20$

$$= 44e^{-0.2t} - 20$$

So, $\frac{dx}{dt} = 0 \Rightarrow 44e^{-0.2t} - 20 = 0 \Leftrightarrow e^{-0.2t} = \frac{20}{44} \Leftrightarrow -0.2t = \log_e\left(\frac{5}{11}\right) \therefore t \approx 3.94$

Checking the nature of the stationary point (to verify the particle has in fact reached its maximum height):

For $t = 3.9$, $\frac{dx}{dt} = 0.17$ and for $t = 4.0$, $\frac{dx}{dt} = -0.23$.

Therefore there is a local maximum when $t = 3.94$. This means that the particle reaches its maximum height after approximately 3.94 seconds.

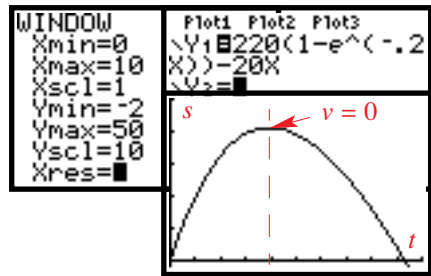

A sketch of the graph of the function x confirms this result.

When discussing velocity, acceleration and displacement as functions of t , it is also important to understand the significance of their signs. This can be summarised by the diagram below:

Displacement:

If $x > 0$, then P is to the right of O.
 If $x < 0$, then P is to the left of O.
 If $x = 0$, then P is at O.

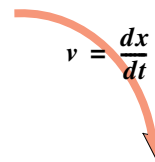

Velocity:

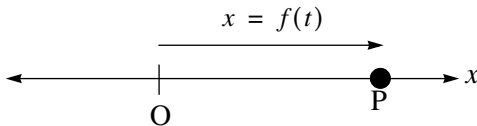

If $v > 0$, then P is moving to the right.
 If $v < 0$, then P is moving to the left.
 If $v = 0$, then P is stationary.

Acceleration:

If $a > 0$, then velocity of P is increasing.
 If $a < 0$, then velocity of P is decreasing.
 If $a = 0$, then velocity of P has a stationary value.

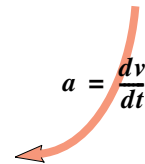

Note also that if both $v > 0$ and $a > 0$ (or $v < 0$ and $a < 0$) i.e., they have the **same sign**, then the

speed of the particle is **increasing**. Whereas, if they have **opposite signs**, then the **speed** of the particle is **decreasing**.

EXAMPLE 21.9

A particle moving in a straight line relative to some origin O, has its displacement, s metres, after being in motion for t seconds, governed by the equation

$$s = t^3 - 4t + 2.$$

- (a) Find the particle's velocity and acceleration at any time t seconds.
- (b) Describe the particle's motion for $t \geq 0$.

Solution

(a) Given that $s = t^3 - 4t + 2$, then the velocity $v = \frac{ds}{dt} = 3t^2 - 4$.

Similarly, its acceleration $a = \frac{dv}{dt} = 6t$.

- (b) We make use of the TI-83 to help us describe the motion of the particle. We first make use of the displacement–time graph:

From the graph we see that the particle started 2 metres to the right of O and then started to move to the left, i.e., $v < 0$.

After passing O, the particle kept moving left until it was stationary, at which point it started to move to the right. It passed the point O again and kept going.

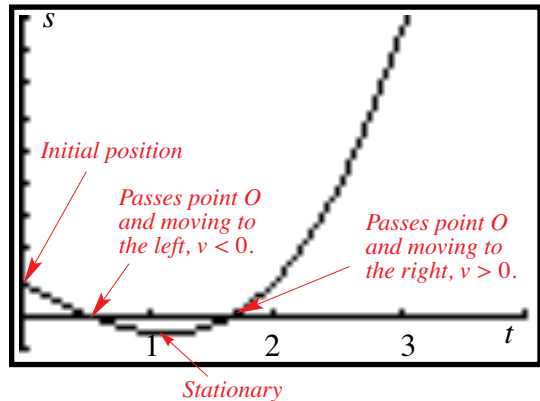

Although this is a basic descriptive account of the particle's motion, more details can be included:

1. Solving for $s = 0$, will tell us when the particle reached the origin.
2. Solving for $v = 0$ will also tell us when the particle was stationary. Which we can then use to determine how far away from the origin it was before returning towards O.

1. Solving for $s = 0 \Rightarrow t^3 - 4t + 2 = 0$. Making use of the **CALC** command on the TI-83, we have that $s = 0$ when $t = 0.54$ and $t = 1.68$. That is, press **2nd CALC** then use the arrow keys to provide two suitable intervals over which a good guess can be made.

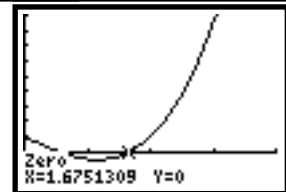
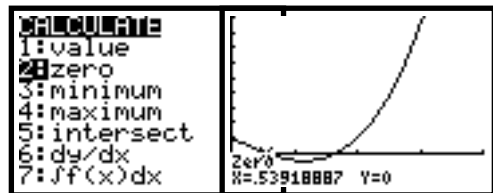

Also note that for $0 < t < 1$, the gradient of the displacement-time curve is negative, i.e., $v < 0$. Then, for $t > 1$, the gradient of the displacement-time curve is positive, i.e., $v > 0$.

MATHEMATICS – Higher Level (Core)

Alternatively we could use the **Solve** option under the **MATH** menu:
Either way, we can quote the result accurately to 2 decimal places.

```
solve(Y1,X,0)
.5391888728
solve(Y1,X,1.5)
1.675130871
```

2. Solving for $v = 0$, is slightly easier in this example as we end up solving a quadratic. That is, $v = 0 \Rightarrow 3t^2 - 4 = 0$, so that

$$t = \pm \sqrt{\frac{4}{3}} \approx \pm 1.15.$$

However, $t \geq 0$, therefore we have that the particle becomes stationary after 1.15 seconds (and then moves to the right).

Note: For $0 \leq t < 1.15$, $v < 0$ but $a > 0$, meaning that the particle is slowing down.

However, for $t > 1.15$, $v > 0$ and $a > 0$, meaning that the particle is speeding up.

EXAMPLE 21.10

A particle's displacement, x metres, from an origin O is defined by the equation $x(t) = \sin 4t - \cos 4t$ at time t seconds.

- Show that the particle's acceleration is proportional to its displacement.
- What is the particle's maximum speed?
- Describe the particle's motion.

Solutions

- (a) We first find the particle's velocity: $v = \frac{dx}{dt} = 4 \cos 4t + 4 \sin 4t$

We then differentiate the velocity equation to obtain the acceleration equation:

$$a = \frac{dv}{dt} = -16 \sin 4t + 16 \cos 4t$$

Now, $a = -16 \sin 4t + 16 \cos 4t = -16(\sin 4t - \cos 4t) = -16x$. Then, as the acceleration is given in terms of x by the relation $a = -16x \Rightarrow a \propto x$, with a constant of proportionality of -16 .

- (b) The maximum speed will occur when the acceleration is zero.

That is, when $a = 0 \Leftrightarrow -16x = 0 \Leftrightarrow x = 0 \Leftrightarrow \sin 4t - \cos 4t = 0$.

Now, $\sin 4t - \cos 4t = 0 \Leftrightarrow \sin 4t = \cos 4t \Leftrightarrow \frac{\sin 4t}{\cos 4t} = 1 \Leftrightarrow \tan 4t = 1$.

$$\therefore 4t = \frac{\pi}{4}, \pi + \frac{\pi}{4}, 2\pi + \frac{\pi}{4}, \dots$$

$$\Leftrightarrow t = \frac{\pi}{16}, \frac{5\pi}{16}, \frac{9\pi}{16}, \dots$$

We can use a graph of the velocity function to help us determine which critical value(s) lead to a maximum and which ones lead to a minimum. However, it is important to understand the difference between speed and velocity. Velocity is a vector quantity and so has a direction associated with it, whereas speed is simply the magnitude of the velocity.

```
WINDOW
Xmin=0
Xmax=6.2831853...
Xscl=.78539816...
Ymin=-6
Ymax=6
Yscl=1
Xres=■
```

($= 2\pi$)
($= \frac{\pi}{4}$)

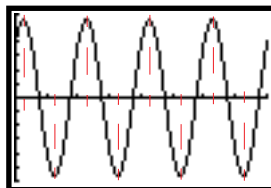

The maximum speed will then occur at all critical values (as we are only interested in the magnitude of the velocity).

So, at $t = \frac{\pi}{16}$, $v = 4\cos\left(\frac{4\pi}{16}\right) + 4\sin\left(\frac{4\pi}{16}\right) = 4 \times \frac{1}{\sqrt{2}} + 4 \times \frac{1}{\sqrt{2}} = \frac{8}{\sqrt{2}} = 4\sqrt{2}$ and so the

maximum speed is $4\sqrt{2}$ m/s.

Had we selected $t = \frac{5\pi}{16}$, then $v = 4\cos\left(\frac{20\pi}{16}\right) + 4\sin\left(\frac{20\pi}{16}\right) = -4\sqrt{2}$ and so, although the

velocity is $-4\sqrt{2}$ m/s, the speed is still $4\sqrt{2}$ m/s. Notice that in this case, the minimum speed is in fact 0 m/s!

(c) Using a displacement-time graph we see that the particle is moving back and forth about the origin O in a periodic manner. Particles describing this type of motion are said to undergo simple harmonic motion (S.H.M).

Its maximum distance from the origin is $\sqrt{2}$ m, which can be verified from the displacement-time equation as follows:

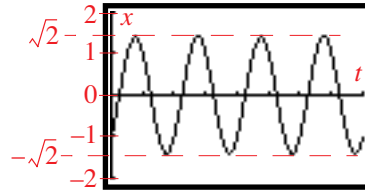

$$x(t) = \sin 4t - \cos 4t \Rightarrow \frac{dx}{dt} = 4\cos 4t + 4\sin 4t \therefore \frac{dx}{dt} = 0 \Leftrightarrow 4\cos 4t + 4\sin 4t = 0$$

$$\Leftrightarrow \sin 4t = -\cos 4t$$

$$\Leftrightarrow \tan 4t = -1$$

$$\text{i.e., } 4t = \frac{3\pi}{4}, \frac{7\pi}{4}, \dots$$

$$\therefore t = \frac{3\pi}{16}, \frac{7\pi}{16}, \dots$$

$$\text{At } t = \frac{3\pi}{16}, x = \sin 4\left(\frac{3\pi}{16}\right) - \cos 4\left(\frac{3\pi}{16}\right) = \sin\left(\frac{3\pi}{4}\right) - \cos\left(\frac{3\pi}{4}\right) = \frac{1}{\sqrt{2}} - \left(-\frac{1}{\sqrt{2}}\right) = \frac{2}{\sqrt{2}} = \sqrt{2}.$$

$$\text{At } t = \frac{7\pi}{16}, x = \sin 4\left(\frac{7\pi}{16}\right) - \cos 4\left(\frac{7\pi}{16}\right) = \sin\left(\frac{7\pi}{4}\right) - \cos\left(\frac{7\pi}{4}\right) = -\frac{1}{\sqrt{2}} - \frac{1}{\sqrt{2}} = -\frac{2}{\sqrt{2}} = -\sqrt{2}.$$

The particle's extreme displacements are $\pm\sqrt{2}$ m and it is undergoing S.H.M with a period of $\frac{\pi}{4}$.

EXAMPLE 21.11

A particle is moving in a straight line. At time t seconds its position, s m from an origin O, is defined by the equation $s(t) = 2^t - 2\log_2 t$, $t \geq 0$.

(Give your answers to 2 decimal places.)

- What is the closest that the particle will get to the origin?
- Find its velocity after 2 seconds.

S
o
l
u
t
i
o
n

(a) We start by sketching the displacement-time graph:

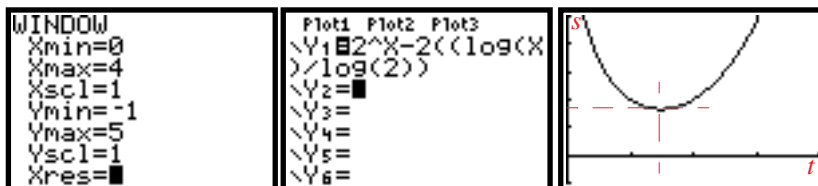

MATHEMATICS – Higher Level (Core)

To determine the closest it gets to the origin we need to determine the minimum value of s .

$$\text{So, given that } s(t) = 2^t - 2\log_2 t \Rightarrow \frac{ds}{dt} = (\ln 2)2^t - \frac{2}{(\ln 2)t}.$$

$$\text{Then, } \frac{ds}{dt} = 0 \Leftrightarrow (\ln 2)2^t - \frac{2}{(\ln 2)t} = 0 \Leftrightarrow (\ln 2)^2 2^t t - 2 = 0 \Leftrightarrow 2^t t = \frac{2}{(\ln 2)^2}.$$

For which there is no exact solution. However, using the graphics calculator and the **Solve** function gives $t = 1.4860\dots$, and then substituting this value of t back into the displacement equation to obtain the minimum value of s . However, we could use the **fMin** function in the **MATH** menu and then find the value of the function for that particular value of t :

Notice that we used the graph to provide an indication of the domain where the minimum value would most likely be – i.e., the lower bound ($t = 1$) and upper bound ($t = 2$).

```
fMin(Y1,X,1,2)
1.486049961
Y1(Ans)
1.658244407
```

Therefore, the closest the particle will get to the origin is 1.66 m.

(b) The velocity, v , is given by $\frac{ds}{dt} = (\ln 2)2^t - \frac{2}{(\ln 2)t}$.

$$\text{So, when } t = 2, \frac{ds}{dt} = (\ln 2)2^2 - \frac{2}{2(\ln 2)} = 4\ln 2 - \frac{1}{\ln 2} \approx 1.3298\dots = 1.33 \text{ (2 d.p.)}$$

Again, the TI-83 is very useful in problems such as these. Simply set Y_2 to be the derivative of Y_1 , i.e., use the **nDeriv**(option in the **MATH** menu and then evaluate Y_2 for $t = 2$:

That is, the particle's velocity after 2 s is 1.33 m/s

```
Plot1 Plot2 Plot3
Y1=2^X-2((log(X)
)/log(2))
Y2=nDeriv(Y1,X,
X)
Y3=
Y4=
Y5=
Y2(2)
1.329893783
```

EXERCISES 21.3

1. Find
 - i. the velocity equation
 - ii. the acceleration equation
 for the following displacement equations
 - (a) $x = \frac{t}{t-1}, t > 1$
 - (b) $x = (e^t - e^{-t})^2, t \geq 0$
 - (c) $s = \text{Sin}^{-1}\left(\frac{t}{2}\right) - \text{Cos}^{-1}\left(\frac{t}{2}\right), 0 \leq t \leq 2$
 - (d) $s = t \log_{10}(t+1), t \geq 0$
 - (e) $x = at + be^{-t^2}, t \geq 0$
 - (f) $x = 2^{t+1} - 3^t, t \geq 0$

2. A particle moving in a straight line is such that its displacement in metres from some origin O at time t seconds is given by $s = t^2 + 4t - 5, t \geq 0$.
 - (a) What is the particle's velocity after travelling for 2 seconds?
 - (b) When is the particle at rest?
 - (c)
 - i. Where is the particle (relative to O) when its motion begins?
 - ii. What is the particle's initial velocity?

- (d) What is the furthest this particle gets from O during the first 5 seconds of motion?
- (e) Sketch the displacement-time graph for this particle.

3. A particle moves in a straight line so that its displacement, s metres, from a fixed origin after t seconds, is given by the formula $s = t^3 - 2t^2 + t$, $t \geq 0$.

- (a) What is the particle's initial velocity?
- (b) How many times will the particle pass through the origin?
- (c) When will the particle be stationary?
- (d) What is the particle's acceleration after 4 seconds?

4. A particle moving in a straight line has its displacement governed by the equation

$$s = -2t^3 + 12t - 1, t \geq 0,$$

where s is measured in metres and t in seconds.

- (a) Find the particle's velocity and acceleration at time t .
- (b) When will the particle come to rest?
- (c) How often does the particle change its direction of motion?
- (d) Sketch a displacement-time graph for this particle.

5. A particle has its displacement defined by $s = 4 \sin t + 3 \cos t$, $t \geq 0$.

- (a) What is the particle's initial position?
- (b) i. What is the particle's maximum displacement from the origin?
ii. What is the particle's maximum displacement from its initial position?
- (c) What is the particle's maximum speed?
- (d) Show that its acceleration, a , is given by $a = -s$.
- (e) Describe the motion of this particle.

6. The displacement of an object from an origin O is given by $s = \frac{g}{k} \left(t + \frac{1}{k} e^{-kt} - \frac{1}{k} \right)$, $t \geq 0$.

- (a) Show that its velocity is given by $v = \frac{g}{k} (1 - e^{-kt})$, $t \geq 0$.
- (b) Show that its acceleration is given by $g - kv$.

7. A particle moving along a straight line has its displacement, x metres, from a fixed origin O, at time t seconds, governed by the equation

$$x = t^3 - 17t^2 + 80t - 100, t \geq 0$$

- (a) Find the particle's initial position.
- (b) How many times will the particle pass through the origin?
- (c) Find the particle's initial i. velocity. ii. acceleration.
- (d) Find the particle's maximum displacement from the origin for $0 \leq t \leq 10$.

8. A particle travelling in a straight line has its displacement from an origin O, given by the equation

$$x = 3 \cos(2t - \pi) + 2, t \geq 0.$$

- (a) Find the maximum and minimum displacement.
- (b) How long is it between successive times when the particle is at rest?
- (c) Find the particle's acceleration i. in terms of t .
ii. in terms of its displacement.

MATHEMATICS – Higher Level (Core)

- 9.** A body is projected vertically upward so that its height, h metres, from ground level at any time t seconds is given by

$$h(t) = 15(1 - e^{-0.25t}) - 3t, t \geq 0.$$

- (a) Find its position from ground level 1 second after being projected.
- (b) Find the body's i. velocity, $v \text{ ms}^{-1}$ ii. acceleration, $a \text{ ms}^{-2}$ at any time t seconds.
- (c) What is the maximum height reached by the body?
- (d) Find an expression for the acceleration in terms of its velocity.
- 10.** A particle is moving along a straight line in such a way that its displacement, s metres, from a fixed point O at time t seconds is given by $s(t) = 2t^3 - 3t^2, t \geq 0$. Find the times for which
- (a) the particle's speed is increasing.
- (b) the particle's velocity is increasing.
- (c) the particle is at least 1 metre from O over the first 5 seconds.
- 11.** Two particles, A and B, are moving along adjacent parallel straight tracks, so that their displacements are given by the equations $x_A = 4 - e^{0.3t}, t \geq 0$ and $x_B = 10te^{-t}, t \geq 0$.
- (a) Describe the motion of each particle.
- (b) How many times will the particles pass each other?
- (c) At what times will the particles pass each other? Give your answer to two decimal places.
- (d) Find an expression for the velocity of particle i. A ii. B
- (e) Will the particles ever have the same speed at the same time?
- 12.** A particle moving in a straight line has its displacement, x m, from a fixed point O given by $x(t) = \sqrt{t^2 + 4} - \sqrt{2}t, 0 \leq t \leq 10$, where t is measured in seconds.
- (a) Find the particle's initial position.
- (b) When will the particle first
- i. reach the origin.
- ii. come to rest.
- (c) Find the particle's acceleration after 5 seconds.
- 13.** A particle's position along a straight line is governed by the equation

$$x = 5 \sin\left(2t - \frac{\pi}{2}\right) + 9, 0 \leq t \leq 3\pi$$

where x is measured in metres from a fixed origin O and time t is measured in seconds.

- (a) Sketch the displacement-time graph for this particle.
- (b) For what proportion of time will the particle be at least 12 metres from the origin?

- 14.** A particle moving in a straight line has its displacement, x m, from a fixed point O given by $x(t) = 5t - 5^{\frac{1}{2}t}, t \geq 0$, where t is measured in seconds.

- (a) Sketch the displacement-time graph for this particle.
- (b) Find the particle's i. velocity ii. acceleration after 5 seconds.
- (c) When will the particle come to rest?
- (d) What is the furthest that the particle travels to the right of O?

21.4 RELATED RATES

So far we have only dealt with rates of change that involve one independent variable. For example, the volume, V units³, of a sphere of radius r units is given by $V = \frac{4}{3}\pi r^3$. To find the rate of change of the volume with respect to its radius we differentiate with respect to r :

$$\text{i.e., } \frac{dV}{dr} = \frac{4}{3}\pi \times 3r^2 = 4\pi r^2.$$

Now consider this sphere being placed in an acid solution so that it dissolves in such a way that

1. it maintains its spherical shape, and
2. its radius is decreasing at a rate of 1 cm/hr.

How can we find the rate at which its volume is changing when the sphere's radius is 2 cm?

Note that we are looking for the *rate of change of volume* that is, we want to find $\frac{dV}{dt}$ (not $\frac{dV}{dr}$ as we found previously – when we specifically requested the rate of change with respect to r).

The difference here is that we want the rate of change of one quantity (in this case the volume) which is related to a second variable (in this case the radius r) which is itself changing.

Problems of this type are known as **related rates** problems and are usually solved by making use of the chain rule.

We now consider the problem at hand. We have:

Want: *rate of change of volume* that is, we want to find $\frac{dV}{dt}$.

When: when $r = 2$.

Given: radius is decreasing at a rate of 1 cm/hr – that is, $\frac{dr}{dt} = -1$

Need: This is the tricky bit. Knowing that we will need to use the chain rule, we start by writing down the chain rule with the information we have. Then we try to fill in the missing pieces.

This will often lead to what we need.

Step 1: $\frac{dV}{dt} = \boxed{\quad} \times \frac{dr}{dt}$

Step 2: Ask yourself the following question:
 “What do I need in the missing space to complete the chain rule?”

The missing piece of information in this case is $\frac{dV}{dr}$.

That is, we have $\frac{dV}{dt} = \frac{dV}{dr} \times \frac{dr}{dt}$, which works!

Step 3: Once you have decided on what you need, then find an equation that will enable you to differentiate.

Some warning! Step 3 is the tough bit in the question. Sometimes we are lucky and we know of an equation but sometimes we need to somehow ‘create’ the equation.

MATHEMATICS – Higher Level (Core)

In this case we do have an equation; $V = \frac{4}{3}\pi r^3 \therefore \frac{dV}{dr} = 4\pi r^2$. And so, using the chain rule we

have:
$$\frac{dV}{dt} = 4\pi r^2 \times \frac{dr}{dt}$$

Note: It is **very important** not to substitute any values until the very end.

The last step is to find $\frac{dV}{dt}$ at the specified radius with the given rate, $\frac{dr}{dt} = -1$. That is,

$\frac{dV}{dt} = 4\pi(2)^2 \times -1 = -16\pi$. So, the volume is decreasing at $16\pi \text{ cm}^3/\text{hr}$.

EXAMPLE 21.12

The radius of a circular oil patch is increasing at a rate of 1.2 cm per minute. Find the rate at which the surface area of the patch is increasing when the radius is 25 cm.

Solution

From the data, $\frac{dr}{dt} = 1.2$. This is the mathematical formulation of the statement ‘the radius of a circular oil patch is increasing at a rate of 1.2 cm per minute’ where r is the radius and t is the time (in the units given in the question). The radius is increasing and so the rate is positive. The next step is to identify the rate of change that we have been asked to calculate. In this case, the question asks: ‘find the rate at which the surface area of the patch is increasing’.

If we define the area as $A \text{ cm}^2$, the required rate is $\frac{dA}{dt}$.

So we have

Want:	$\frac{dA}{dt}$
When:	$r = 25$
Given:	$\frac{dr}{dt} = 1.2$

Need: We make use of the chain rule: $\frac{dA}{dt} = \boxed{} \times \frac{dr}{dt}$.

The missing piece must therefore be $\frac{dA}{dr}$!

Therefore, we have, $\frac{dA}{dt} = \frac{dA}{dr} \times \frac{dr}{dt}$. All we need to do is find an expression for A in terms of r .

This can be done by looking at the geometry of the situation. The oil patch is circular and so the area is given by $A = \pi r^2 \Rightarrow \frac{dA}{dr} = 2\pi r$.

Substituting into the chain rule gives: $\frac{dA}{dt} = 2\pi r \times \frac{dr}{dt}$.

Then, with $r = 25$ and $\frac{dr}{dt} = 1.2$ we have: $\frac{dA}{dt} = 2\pi(25) \times 1.2 = 60\pi \approx 188.5 \text{ cm}^2\text{min}^{-1}$.

That is, the area is increasing at approximately $188.5 \text{ cm}^2\text{min}^{-1}$.

Note: A useful check that the chain rule has been used appropriately is to make use of the units of the quantities involved. For example 21.12 we have that

$$\frac{dA}{dt} = \frac{dA}{dr} \times \frac{dr}{dt} = \text{cm}^2\text{cm}^{-1} \times \text{cm}^1\text{min}^{-1} = \text{cm}^2\text{min}^{-1} \text{ which is the correct unit for } \frac{dA}{dt}.$$

EXAMPLE 21.13

The volume of a cube is increasing at $24 \text{ cm}^3\text{s}^{-1}$. At what rate are the side lengths increasing when the volume is 1000 cm^3 ?

Solution

We start by determining what variables are involved and see if a diagram might be helpful – usually one is (even if it's only used to visualise the situation). In this case we are talking about a volume and a length, so we let $V \text{ cm}^3$ denote the volume of the cube of side length $x \text{ cm}$.

Giving us the expression $V = x^3$.

Next we list all of the information according to our *want, when, given* and *need*:

Want: $\frac{dx}{dt}$

When: $V = 1000$

Given: $\frac{dV}{dt} = 24$

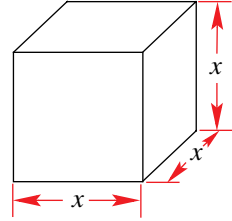

Need: Using the chain rule we have: $\frac{dx}{dt} = \boxed{\quad} \times \frac{dV}{dt}$ and so, we need $\frac{dx}{dV}$.

So that $\frac{dx}{dt} = \frac{dx}{dV} \times \frac{dV}{dt}$. However, we have V as a function of x and so it will be easier to first find

$$\frac{dV}{dx} \text{ and then use the fact that } \frac{dx}{dV} = \frac{1}{\frac{dV}{dx}}. \text{ Then, as } V = x^3 \Rightarrow \frac{dV}{dx} = 3x^2 \Rightarrow \frac{dx}{dt} = \frac{1}{3x^2} \times \frac{dV}{dt},$$

We know $\frac{dV}{dt} = 24$ but, still need a value for x . From $V = x^3$ we have $1000 = x^3 \therefore x = 10$.

$$\text{So, } \frac{dx}{dt} = \frac{1}{3(10)^2} \times 24 = \frac{8}{100} = 0.08. \text{ That is, the side lengths are increasing at } 0.08 \text{ cm s}^{-1}.$$

It is important to realise that when we reach the ‘**Need:**’ stage there are more ways than one to use the chain rule.

For example, with Example 21.13, rather than using $\frac{dx}{dt} = \frac{dx}{dV} \times \frac{dV}{dt}$ and then realising that we

need to find $\frac{dV}{dx}$ and then invert it, we could have used the chain rule as follows:

$$\frac{dV}{dt} = \frac{dV}{dx} \times \frac{dx}{dt} \text{ so that } 24 = 3x^2 \times \frac{dx}{dt} \Leftrightarrow \frac{dx}{dt} = \frac{24}{3x^2}.$$

Using the chain rule in this manner has a certain ‘logical flow’ to it, in that everything seems to ‘fit nicely’. But remember, as long as the chain rule expression contains the ‘*need*’, ‘*want*’ and ‘*given*’ it should not make much difference at the end. All that we can say is that as you solve more and more of these problems you will be able to make the ‘best’ decision available at the time.

EXAMPLE 21.14

The angle contained by two sides of fixed lengths 10 cm of a triangle is decreasing at 0.1π rad/sec. Find the rate at which the side length opposite this angle is changing at the instant when the angle is 30° .

Solution

For this problem we will need to

1. introduce some variables
2. draw a diagram

Let the angle in question be θ radians and the side length opposite this angle be x cm.

Next, we go through our list:

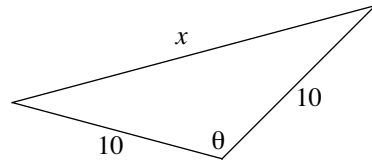

Want: $\frac{dx}{dt}$

When: $\theta = 30 \times \frac{\pi}{180} = \frac{\pi}{6}$ [Note that we needed to convert to radians]

Given: $\frac{d\theta}{dt} = -0.1\pi$ [Notice the negative sign. This is because θ is decreasing]

Need: Using the chain rule we have: $\frac{dx}{dt} = \boxed{-}$ $\times \frac{d\theta}{dt}$ and so, we need $\frac{dx}{d\theta}$.

The next step then is to find an expression for x in terms of θ . Using our diagram, it appears that the cosine rule would be useful. For this triangle we have:

$$x^2 = 10^2 + 10^2 - 2 \times 10 \times 10 \times \cos \theta \text{ i.e., } x^2 = 200 - 200 \cos \theta \therefore x = \pm \sqrt{200 - 200 \cos \theta}.$$

However, as $x > 0$, we have that $x = \sqrt{200 - 200 \cos \theta}$ and so,

$$\begin{aligned} \frac{dx}{d\theta} &= \frac{1}{2} \cdot (200 \sin \theta) \cdot (200 - 200 \cos \theta)^{-1/2} \\ &= \frac{100 \sin \theta}{\sqrt{200 - 200 \cos \theta}} \end{aligned}$$

[Note: $\sqrt{200 - 200 \cos \theta} = \sqrt{100(2 - 2 \cos \theta)} = 10\sqrt{2 - 2 \cos \theta}$]

We can now continue with the chain rule:

$$\begin{aligned} \frac{dx}{dt} &= \frac{dx}{d\theta} \times \frac{d\theta}{dt} = \frac{100 \sin \theta}{\sqrt{200 - 200 \cos \theta}} \times -0.1\pi = -\frac{10\pi \sin \theta}{10\sqrt{2 - 2 \cos \theta}} \\ &= -\frac{\pi \sin \theta}{\sqrt{2 - 2 \cos \theta}} \end{aligned}$$

Again, we do not substitute the ‘when’ part of the problem until we have an expression for $\frac{dx}{dt}$.

$$\text{Now, when } \theta = \frac{\pi}{6}, \frac{dx}{dt} = -\frac{\pi \times \sin \frac{\pi}{6}}{\sqrt{2 - 2 \cos \frac{\pi}{6}}} = -\frac{\pi \times \frac{1}{2}}{\sqrt{2 - 2 \times \frac{\sqrt{3}}{2}}} = -\frac{\pi}{2\sqrt{2 - \sqrt{3}}} \approx -3.0345.$$

So, the side opposite the angle is **decreasing** at 3.03 cm/s (answer given to 2 d.p).

Can you come up with a shorter solution? Hint: show that $x = 20 \sin\left(\frac{1}{2}\theta\right)$.

We now consider problems that require us to draw at least one diagram to help us find a solution. For problems such as these we draw one diagram to help us get a feel for the situation, then draw a second that only includes information that we will use to obtain relationships between the variables. In fact, in order to determine relationships between variables that deal with geometrical shapes we often draw a cross section of the shape in question. Once that is done, and we have labelled the diagram with the variables, it becomes easier to decide what geometrical relationships should be used, e.g., Pythagoras's rule, similar triangles, distance formula and so on.

EXAMPLE 21.15

A container in the shape of an inverted right circular cone of base radius 10 cm and height 50 cm has water poured into it at a rate of $5 \text{ cm}^3 \text{ min}^{-1}$. Find the rate at which the level of the water is rising when it reaches a height of 10 cm.

**S
o
l
u
t
i
o
n**

Let the water level at time t min have a height h cm with a corresponding radius r cm and volume $V \text{ cm}^3$.

We now list our requirements:

Want: $\frac{dh}{dt}$

When: $h = 10$

Given: $\frac{dV}{dt} = 5$

Need: Using the chain rule we have: $\frac{dV}{dt} = \frac{dV}{dh} \times \frac{dh}{dt}$ and so, we need $\frac{dV}{dh}$.

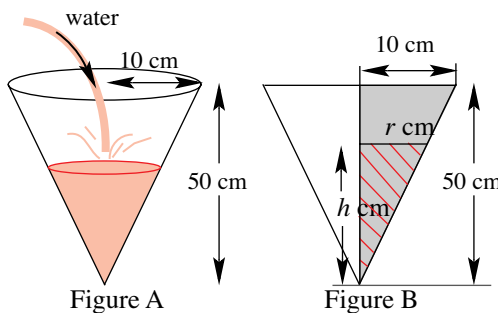

Before we can find $\frac{dV}{dh}$ we will need to find an expression for V in terms of h . We do this by making use of Figure B – a cross section of the inverted cone. The information in Figure B prompts us to make use of similar triangles.

We then have, $\frac{50}{10} = \frac{h}{r} \Leftrightarrow r = \frac{1}{5}h$. The volume of water in the cone when it reaches a height

h cm is given by $V = \frac{1}{3}\pi r^2 h$. Then, substituting the expression $r = \frac{1}{5}h$ into the volume equation

we have that $V = \frac{1}{3}\pi\left(\frac{1}{5}h\right)^2 h = \frac{\pi}{75}h^3 \Rightarrow \frac{dV}{dh} = \frac{\pi}{25}h^2$.

We can now complete the chain rule: $\frac{dV}{dt} = \frac{dV}{dh} \times \frac{dh}{dt} \therefore \frac{dV}{dt} = \frac{\pi}{25}h^2 \times \frac{dh}{dt}$

$$5 = \frac{\pi}{25}h^2 \times \frac{dh}{dt}$$

$$\Leftrightarrow \frac{dh}{dt} = \frac{125}{\pi h^2}$$

Then, when $h = 10$, we have $\frac{dh}{dt} = \frac{125}{100\pi} \approx 0.3978$. i.e., approximately 0.4 cms^{-1} .

That is, the water level is rising at 0.4 cms^{-1} .

EXAMPLE 21.16

A ladder 8 metres long is leaning against a vertical wall. If the top of the ladder is slipping down from the wall at 0.4 m/s, how fast is the bottom of the ladder sliding along the ground when the bottom of the ladder is 3 m from the wall?

Solution

We start with an appropriate diagram and then we introduce the variables.

Let the top of the ladder be y m from the ground at any time t seconds and let the bottom of the ladder be x m from the wall at time t seconds. We now list our requirements:

Want: $\frac{dx}{dt}$

When: $x = 3$

Given: $\frac{dy}{dt} = -0.4$ [It is a negative rate because y is decreasing]

Need: Using the chain rule we have: $\frac{dx}{dt} = \boxed{-}$ $\times \frac{dy}{dt}$ and so, we need $\frac{dx}{dy}$.

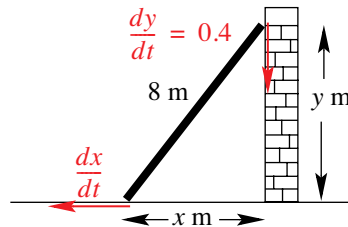

To find $\frac{dx}{dy}$ we need to obtain an expression for x in terms of y . From the diagram, an ‘obvious’

approach is to use Pythagoras’s Theorem. So that $8^2 = x^2 + y^2$. i.e., $x^2 + y^2 = 64$.

Then, if $x^2 + y^2 = 64 \Rightarrow x = \pm\sqrt{64 - y^2}$.

But, $x \geq 0$, therefore, $x = \sqrt{64 - y^2}$.

This then gives $\frac{dx}{dy} = \frac{1}{2} \cdot (-2y) \cdot (64 - y^2)^{-1/2} = -\frac{y}{\sqrt{64 - y^2}}$

We then have that $\frac{dx}{dt} = -\frac{y}{\sqrt{64 - y^2}} \times \frac{dy}{dt} = -\frac{y}{\sqrt{64 - y^2}} \times -0.4 = \frac{0.4y}{\sqrt{64 - y^2}}$.

Then, when $x = 3$, $3^2 + y^2 = 64 \Leftrightarrow y^2 = 55 \therefore y = \pm\sqrt{55}$, but, $y \geq 0$ therefore, $y = \sqrt{55}$.

Substituting this into the expression for $\frac{dx}{dt}$ we have: $\frac{dx}{dt} = \frac{0.4\sqrt{55}}{\sqrt{9}} = 0.4\sqrt{\frac{55}{9}} \approx 0.9888$.

That is, the bottom of the ladder is moving away from the wall at approximately 0.99 m/s.

We now solve Example 21.16 using a different approach. This time we will make use of implicit differentiation. Using the relationship between x and y , that is, $x^2 + y^2 = 8^2$, we proceed by differentiating both sides with respect to t :

$$x^2 + y^2 = 64 \therefore \frac{d}{dt}(x^2 + y^2) = \frac{d}{dt}(64) \Rightarrow 2x \cdot \frac{dx}{dt} + 2y \cdot \frac{dy}{dt} = 0$$

We know that $\frac{dy}{dt} = -0.4$ and that when $x = 3$, $y = \sqrt{55}$.

From $2x \cdot \frac{dx}{dt} + 2y \cdot \frac{dy}{dt} = 0$ we have: $2 \times 3 \times \frac{dx}{dt} + 2\sqrt{55} \cdot (-0.4) = 0 \Rightarrow \frac{dx}{dt} = \frac{2 \times \sqrt{55} \times 0.4}{2 \times 3}$

That is, $\frac{dx}{dt} = \frac{0.4\sqrt{55}}{3} \approx 0.9888$ (giving us the same answer as before).

The use of implicit differentiation in related rates problems can often reduce the work and provide a somewhat more elegant solution.

EXAMPLE 21.17

A weight is attached to a rope 20 m long which passes over a pulley that is 8 m above the ground level. The other end of the rope is attached to a point on a bike 1 m above ground level. If the bike moves away from the pulley and along the ground at a constant rate of 4 m/s, how fast is the weight rising when it is 4 m above the ground level?

S

- Let y m denote the distance from the ground that the weight has been raised after t seconds and let x m be the horizontal distance the bike has moved along the ground. Let the weight be located at A , the pulley at B and the bike at C .

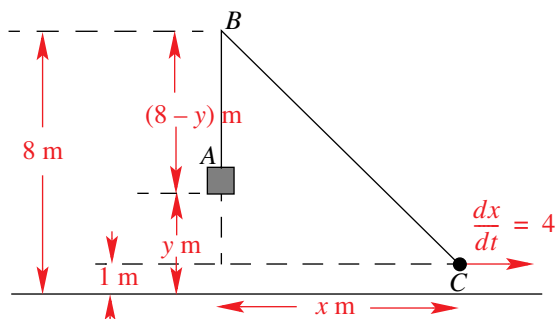

We now list our requirements:

Want: $\frac{dy}{dt}$

When: $y = 4$

Given: $\frac{dx}{dt} = 4$

Need: Using the chain rule we have: $\frac{dy}{dt} = \boxed{-}$ $\times \frac{dx}{dt}$ and so, we need $\frac{dy}{dx}$.

Our task is to find an expression for y in terms of x . Using the above diagram we have that

$$x^2 + 7^2 = (BC)^2$$

Then, as the rope has a fixed length of 20 m it must be the case that $AB + BC = 20$.

That is, $(8 - y) + BC = 20 \Leftrightarrow BC = 20 - (8 - y)$

$$\therefore BC = 12 + y$$

So, we now have that

$$x^2 + 49 = (12 + y)^2$$

However, rather than expressing y in terms of x , we use implicit differentiation, i.e., differentiate both sides with respect to t :

$$\frac{d}{dt}(x^2 + 49) = \frac{d}{dt}[(12 + y)^2]$$

$$\therefore 2x \cdot \frac{dx}{dt} = 2 \cdot (12 + y) \cdot \frac{dy}{dt}$$

$$\Rightarrow \frac{dy}{dt} = \frac{x}{12 + y} \cdot \frac{dx}{dt}$$

When $y = 4$, we have $x^2 + 49 = (12 + 4)^2 \Rightarrow x = \sqrt{207}$ (as $x > 0$) and with $\frac{dx}{dt} = 4$ we have

$$\frac{dy}{dt} = \frac{\sqrt{207}}{12 + 4} \times 4 = \frac{1}{4}\sqrt{207} \approx 3.5969. \text{ The weight is moving up at approximately 3.6 m/s.}$$

EXAMPLE 21.18

A lighthouse located 200 metres from a straight shoreline emits a beam which makes 1 revolution every minute. How fast, in m/s, is the beam moving along the shoreline when it

- (a) is at a right angle to the shoreline?
- (b) is 50 metres along the shoreline from the point directly opposite the lighthouse?

S
o
I
u
t
i
o
n

In this problem we need to create a ‘model’ of the situation – that is, we will need to make some assumptions and simplifications about the situation. We do this by drawing a diagram to represent the location of the lighthouse, the shoreline and the direction of rotation of the beam. From our diagram we see that the angle θ is increasing when the beam reaches point C. Had we drawn it so that it was rotating clockwise, θ would be decreasing. We now list our requirements:

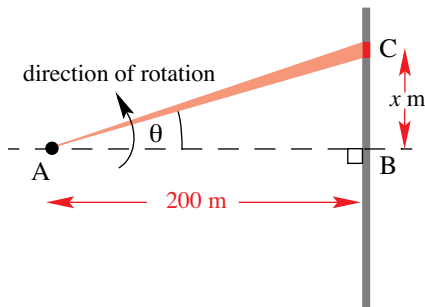

Want: $\frac{dx}{dt}$

When: θ to be determined

Given: $\frac{d\theta}{dt} = 1 \text{ revs/minute} = 1 \times \frac{2\pi}{60} \text{ radians/sec}$ [We must first convert to rad/s]
 $= \frac{\pi}{30} \text{ rad/s}$

Need: Using the chain rule we have: $\frac{dx}{dt} = \boxed{\quad} \times \frac{d\theta}{dt}$ and so, we need $\frac{dx}{d\theta}$.

We need to find an expression for x in terms of θ .

From our diagram we have:

$$\tan \theta = \frac{BC}{AB} = \frac{x}{200} \Leftrightarrow x = 200 \tan \theta \Rightarrow \frac{dx}{d\theta} = 200 \times \sec^2 \theta$$

From the chain rule we have $\frac{dx}{dt} = (200 \times \sec^2 \theta) \times \left(\frac{\pi}{30}\right) = \frac{20\pi}{3} \sec^2 \theta$.

(a) When the beam is at a right angle to the shoreline $\theta = 0$. $\therefore \frac{dx}{dt} = \frac{20\pi}{3} \sec^2(0) = \frac{20\pi}{3}$

That is, $\frac{dx}{dt} \approx 20.9439$. So the beam is moving at approximately 20.9 m/s.

(b) When the beam is 50 metres along the shoreline (as in the diagram), $\tan \theta = \frac{50}{200} = \frac{1}{4}$.

Using the identity $\tan^2 \theta + 1 = \sec^2 \theta$ we have $\sec^2 \theta = 1 + (0.25)^2 = 1.0625 = \frac{17}{16}$.

Then, substituting into $\frac{dx}{dt} = \frac{20\pi}{3} \sec^2 \theta$ we have, $\frac{dx}{dt} = \frac{20\pi}{3} \times \frac{17}{16} = \frac{85\pi}{12} \approx 22.25$. That is, the beam is moving along the shore line at approximately 22.25 m/s.

EXAMPLE 21.19

A solid sphere is dissolving uniformly in such a way that its radius is decreasing at a rate of 2% per second. At what % rate is its volume decreasing?

S
o
l
u
t
i
o
n

Let the sphere have a volume $V \text{ cm}^3$ and radius $r \text{ cm}$ at any time t seconds.

We list our requirements:

Want: $\frac{dV}{dt}$

When: Answer to be given as a % of the volume, V .

Given: $\frac{dr}{dt} = -2\%$ of r , i.e., $\frac{dr}{dt} = -\frac{2}{100}r$.

Need: Using the chain rule we have: $\frac{dV}{dt} = \frac{dV}{dr} \times \frac{dr}{dt}$ and so, we need $\frac{dV}{dr}$.

Now, $V = \frac{4}{3}\pi r^3 \Rightarrow \frac{dV}{dr} = 4\pi r^2$ and so, $\frac{dV}{dt} = 4\pi r^2 \times \frac{dr}{dt}$.

Then, $\frac{dV}{dt} = 4\pi r^2 \times -\frac{2}{100}r = -\frac{8}{100}\pi r^3$

But, $\pi r^3 = \frac{3}{4} \times \frac{4}{3}\pi r^3 = \frac{3}{4}V \therefore \frac{dV}{dt} = -\frac{8}{100} \times \frac{3}{4}V = -\frac{6}{100}V$.

The volume is decreasing at 6% per second.

EXAMPLE 21.20

Air is leaking at a rate of $5 \text{ cm}^3 \text{ min}^{-1}$ from a spherical balloon. Find the rate at which the surface area of the balloon is changing when the radius is 10 cm.

S
o
l
u
t
i
o
n

Let the sphere have a volume $V \text{ cm}^3$, surface area $A \text{ cm}^2$ and radius $r \text{ cm}$ at any time t minutes.

We list our requirements:

Want: $\frac{dA}{dt}$

When: $r = 10$

Given: $\frac{dV}{dt} = -5$

Need: Using the chain rule we have: $\frac{dA}{dt} = \frac{dA}{dV} \times \frac{dV}{dt}$ and so, we need $\frac{dA}{dV}$.

To find $\frac{dA}{dV}$ we use the chain rule again, i.e., $\frac{dA}{dV} = \frac{dA}{dr} \times \frac{dr}{dV}$. This means that we need to have an expression for A in terms of r and V in terms of r .

For a sphere these are known:

$$A = 4\pi r^2 \Rightarrow \frac{dA}{dr} = 8\pi r \text{ and } V = \frac{4}{3}\pi r^3 \Rightarrow \frac{dV}{dr} = 4\pi r^2.$$

And so, we have $\frac{dA}{dV} = \frac{dA}{dr} \times \frac{dr}{dV} = \frac{dA}{dr} \times \frac{1}{\left(\frac{dV}{dr}\right)} = 8\pi r \times \frac{1}{4\pi r^2} = \frac{2}{r}$.

MATHEMATICS – Higher Level (Core)

Then, going back to our first chain rule expression we have:

$$\frac{dA}{dt} = \frac{2}{r} \times \frac{dV}{dt} = \frac{2}{r} \times -5 = -\frac{10}{r}.$$

So, when $r = 10$, $\frac{dA}{dt} = -1$. i.e., the surface area is decreasing at $1 \text{ cm}^2\text{s}^{-1}$.

Note: the units of this problem are: $\frac{dA}{dV} = \frac{dA}{dr} \times \frac{dr}{dV} = \frac{dA}{dr} \div \left(\frac{dV}{dr}\right) = \frac{\text{cm}^2}{\text{cm}} \div \left(\frac{\text{cm}^3}{\text{cm}}\right) = \text{cm}^{-1}$

which confirms the units of the answer which was $\frac{2}{r}$.

$\frac{dA}{dt} = \frac{dV}{dt} \times \frac{dA}{dV} = \text{cm}^3\text{min}^{-1} \times \text{cm}^{-1} = \text{cm}^2\text{min}^{-1}$, the correct unit for the final answer.

EXAMPLE 21.21

A spherical tank of radius 15 cm is initially half full of water. The liquid leaks out through a hole at the bottom of the tank at a rate proportional to the square root of the depth of the water at that instant. Find the rate at which the water level is dropping when it reaches a depth of 9 cm. Assume a constant of proportionality of 0.3.

Solution

Let the volume of water in the tank when it reaches a depth h cm at time t seconds be given by $V \text{ cm}^3$. Also, let r cm be the radius of the circular surface area of water when it reaches a depth of h cm.

We list our requirements:

Want: $\frac{dh}{dt}$

When: $h = 9$

Given: $\frac{dV}{dt} = -k\sqrt{h} = -0.3\sqrt{h}$

Need: Using the chain rule we have:

$$\frac{dV}{dt} = \boxed{-} \times \frac{dh}{dt} \text{ and so, we need } \frac{dV}{dh}.$$

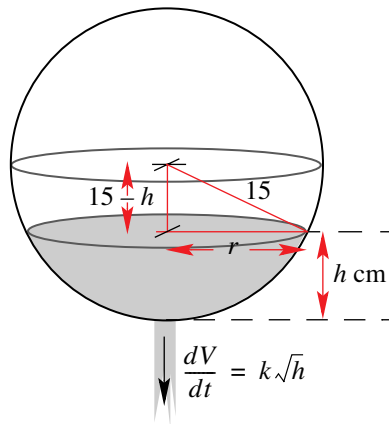

As we do not have a ready made formula for the volume of water in the tank in terms of its depth h , we will need to obtain an expression from ‘scratch’.

Note: We cannot use the formula for the volume of a sphere or a hemisphere because the shape that contains the water is not a sphere or a hemisphere, but rather a ‘cap’.

Consider an element of volume, $\delta V \text{ cm}^3$, for some small ‘increment’ in height, $\delta h \text{ cm}$, then we have a cylindrical

element with volume $\delta V \approx \pi r^2 \delta h \Leftrightarrow \frac{\delta V}{\delta h} \approx \pi r^2$.

Then, as $\delta h \rightarrow 0$ we have, $\lim_{\delta h \rightarrow 0} \frac{\delta V}{\delta h} = \frac{dV}{dh} = \pi r^2$

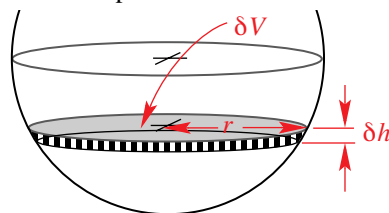

We now have an expression for $\frac{dV}{dh}$. All that remains is to find an expression for r in terms of h .

From our first diagram, we have $15^2 = (15 - h)^2 + r^2$ [Pythagoras's Theorem]

So that, $15^2 = 15^2 - 30h + h^2 + r^2 \Leftrightarrow r^2 = 30h - h^2$

And so, $\frac{dV}{dh} = \pi r^2 = \pi(30h - h^2)$.

Substituting into $\frac{dV}{dt} = \frac{dV}{dh} \times \frac{dh}{dt}$ we have: $\frac{dV}{dt} = \pi(30h - h^2) \times \frac{dh}{dt}$

$$\therefore -0.3\sqrt{h} = \pi(30h - h^2) \times \frac{dh}{dt}$$

$$\Leftrightarrow \frac{dh}{dt} = -\frac{0.3\sqrt{h}}{\pi(30h - h^2)}$$

Therefore, when $h = 9$ we have $\frac{dh}{dt} = -\frac{0.3\sqrt{9}}{\pi(30 \times 9 - 9^2)} = -\frac{1}{210\pi} \approx 0.0015157$.

That is, the depth of water is decreasing at approximately 0.0015 cm/s

EXERCISES 21.4

- The radius of a circle is increasing at 2 cm/s. Find the rate at which
 - its area is increasing.
 - its circumference is increasing.
- The side lengths of a square are increasing at a rate of 3 cm/s. Find the rate at which the area of the square is increasing when its side length is 1 cm.
- The sides of an equilateral triangle are decreasing at a rate of $\sqrt{6}$ cm/s. Find the rate of change of
 - the area of the triangle.
 - the altitude of the triangle.
- A solid 400 gm metal cube of side length 10 cm expands uniformly when heated. If the length of its sides expand at 0.5 cm/hr, find the rate at which, after 5 hours,
 - its volume is increasing.
 - its surface area is increasing.
 - its density is changing.
- A drinking glass is shaped in such a way that the volume of water in the glass when it reaches a height h cm is given by $V = \frac{1}{5}h^3$ cm³. Water is poured into the glass at 2 cm³s⁻¹. At what rate is the water level rising when the depth of water is 3 cm?
- An ice cube, while retaining its shape, is melting and its sidelengths are decreasing at 0.02 cm/min. Find the rate at which the volume is changing when the sides are 2 cm.

MATHEMATICS – Higher Level (Core)

- 7.** A liquid is pumped into an upright cylindrical tank of radius 1.5 m at a rate of $0.25 \text{ m}^3\text{s}^{-1}$. At what rate is the depth of the liquid increasing when it reaches
- (a) a depth of 1.25 m? (b) a volume of $10\pi \text{ m}^3$?

- 8.** A conical pile of sand with a constant vertical angle of 90° is having sand poured onto the top. If the height is increasing at the rate of 0.5 cm min^{-1} , find the rate at which sand is being poured when the height is 4 cm, giving an exact answer.

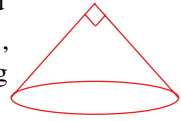

- 9.** An aeroplane flies over an airport at an altitude of 10000 metres and at a speed of 900 kmhr^{-1} . Find the rate at which the actual distance from the airport is increasing 2 minutes after the aeroplane was directly over the airport, correct to the nearest whole number.

- 10.** The temperature inside a chemical reaction vessel, initially 35°C is rising at 7°C per hour. The rate at which the reaction happens is modelled by the function:

rate = $\frac{t}{12} + 3$ where t is the temperature of the reaction vessel in $^\circ\text{C}$. Find the rate at which the reaction is occurring after 5 hours.

- 11.** A racing car, travelling at 180 km per hour, is passing a television camera on a straight road. The camera is 25 metres from the road. If the camera operator follows the car, find the rate (in radians per second) at which the camera must pan (rotate) at the moment when the car is at its closest to the camera.

- 12.** The diagram shows a water trough. Water is being poured into this trough at 2.4 cubic metres per minute.
- (i) Find an expression for the volume of water in the trough in terms of its depth.
- (ii) Find the rate at which the water level is rising when the depth is 0.5 metres.
- (iii) Find the rate at which the exposed surface area of the water is increasing after 1 minute.

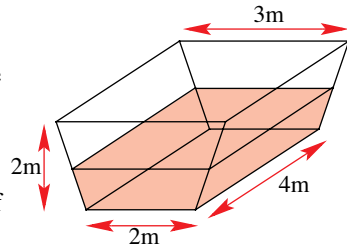

- 13.** A square based pyramid with a fixed height of 20 metres is increasing in volume at $2 \text{ m}^3 \text{ min}^{-1}$. Find the rate at which the side length of the base is increasing when the base has an area of 10 m^2 . Give an exact answer with a rational denominator.

- 14.** The length of the edge of a regular tetrahedron is increasing at 2.5 cm s^{-1} . Find the rate at which the volume is increasing when the edge is 4 cm.

- 15.** A man 1.8 m tall is walking directly away from a street lamp 3.2 m above the ground at a speed of 0.7 m/s. How fast is the length of his shadow increasing?

- 16.** A ladder 10 m long rests against a vertical wall. The bottom of the ladder, while maintaining contact with the ground, is being pulled away from the wall at 0.8 m/s. How fast is the top of the ladder sliding down the wall, when it is 2 m from the ground?

- 17.** A solid ball of radius 30 cm is dissolving uniformly in such a way that its radius is x cm, and is decreasing at a constant rate of 0.15 cm/s, t seconds after the process started.

- (a) Find an expression for the radius of the ball at any time t seconds.
 (b) Find the domain of x .
 (c) Find the rate of change of
 i. the volume of the ball 10 seconds after it started to dissolve.
 ii. the surface area when the ball has a volume of $100\pi \text{ cm}^3$.
 (d) Sketch a graph of the volume of the ball at time t seconds.

- 18.** A fisherman is standing on a jetty and is pulling in a boat by means of a rope passing over a pulley. The pulley is 3 m above the horizontal line where the rope is tied to the boat. At what rate is the boat approaching the jetty if the rope is being hauled at 1.2 m/s, when the rope measures 12 m?

- 19.** A trough, 4 m long, has a cross section in the shape of an isosceles triangle. Water runs into the trough at $0.2 \text{ m}^3\text{s}^{-1}$. Find the rate at which the water level is rising after 10 seconds, if the tank is initially empty.

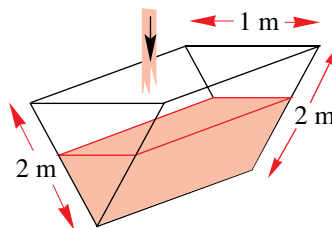

- 20.** A line, 12 m long, meets the x -axis at A and the y -axis at B. If point A, initially 5 m from O, is approaching the origin, O, at 2 m/s, find

- (a) an expression for y in terms of the time, t seconds, since point A started to move.
 (b) the rate at which B is moving when A has travelled 2 m.

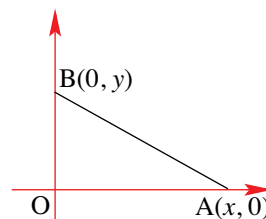

- 21.** The volume $V \text{ cm}^3$ of water in a container at time t seconds, when the depth of water in the container is $x \text{ cm}$ is given by the relationship

$$V = \frac{1}{3}(x + 3)^3 - 9, 0 \leq x \leq 5.$$

- (a) Find the rate at which the water level is increasing after 5 seconds if water flows into the container at $1.2 \text{ cm}^3\text{s}^{-1}$.
 (b) Find the rate of change of the area of the surface of the water after 5 seconds if water is still flowing into the container at $1.2 \text{ cm}^3\text{s}^{-1}$.

- 22.** Two cars, A and B, leave their hometown, T, at the same time but on different freeways. The freeways are straight and at 120° to each other and the cars are traveling at 70 km/h and 80 km/hr respectively. Given that $x \text{ km}$ and $y \text{ km}$ are the distances travelled by the cars A and B respectively t hours after they leave T

- (a) find an expression in terms of t for the distance travelled by car
 i. A ii. B
 (b) find an expression in terms of t for the distance apart cars A and B are after t hours.
 (c) How fast are cars A and B moving apart after 5 hours?
 (d) After travelling for 5 hours, the driver of car B decides to head back to T. How fast are the cars moving apart 3 hours after car B turns back?

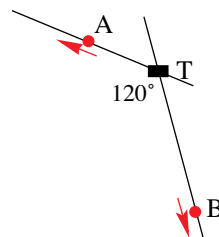

MATHEMATICS – Higher Level (Core)

- 23.** A girl approaches a tower 75 m high at 5 km/hr. At what rate is her distance from the top of the tower changing when she is 50 m from the foot of the tower?
- 24.** Jenny is reeling in her kite, which is maintaining a steady height of 35 m above the reel. If the kite has a horizontal speed of 0.8 m/s towards Jenny, at what rate is the string being reeled in when the kite is 20 m horizontally from Jenny?
- 25.** A kite 60 metres high, is being carried horizontally away by a wind gust at a rate of 4 m/s. How fast is the string being let out when the string is 100 m long?
- 26.** Grain is being released from a chute at the rate of 0.1 cubic metres per minute and is forming a heap on a level horizontal floor in the form of a circular cone that maintains a constant semi-vertical angle of 30° . Find the rate at which the level of the grain is increasing 5 minutes after the chute is opened.
- 27.** A radar tracking station is located at ground level vertically below the path of an approaching aircraft flying at 850 km/h and maintaining a constant height of 9000 m. At what rate in degrees is the radar rotating while tracking the plane when the horizontal distance of the plane is 4 km from the station.
- 28.** A weather balloon is released at ground level and 2500 m from an observer on the ground. The balloon rises straight upwards at 5 m/s. If the observer is tracking the balloon from his fixed position, find the rate at which the observer's tracking device must rotate so that it can remain in-line with the balloon when the balloon is 400m above ground level.
- 29.** The radius of a uniform spherical balloon is increasing at 3% per second.
(a) Find the % rate at which its volume is increasing.
(b) Find the % rate at which its surface area is increasing.
- 30.** A manufacturer has agreed to produce x thousand 10-packs of high quality recordable compact discs and have them available for consumers every week with a wholesale price of $\$k$ per 10-pack. The relationship between x and k has been modelled by the equation
$$x^2 - 2.5kx + k^2 = 4.8$$
At what rate is the supply of the recordable compact discs changing when the price per 10-pack is set at $\$9.50$, 4420 of the 10-pack discs are being supplied and the wholesale price per 10-pack is increasing at 12 cents per 10-pack per week?
- 31.** It has been estimated that the number of housing starts, N millions, per year over the next 5 years will be given by $N(r) = \frac{8}{1 + 0.03r^2}$, where $r\%$ is the mortgage rate. The government believes that over the next t months, the mortgage rate will be given by $r(t) = \frac{8.6t + 65}{t + 10}$. Find the rate at which the number of housing starts will be changing 2 years from when the model was proposed.
- 32.** The volume of a right circular cone is kept constant while the radius of the base of the cone is decreasing at 2% per second. Find the % rate at which the height of the cone is changing.
- 33.** The radius of a sector of fixed area is increasing at 0.5 m/s. Find the rate at which the angle in radians of the sector is changing when the ratio of the radius to the angle is 4.

21.5 APPLIED MAXIMA AND MINIMA PROBLEMS

21.5.1 MAXIMA-MINIMA PROBLEMS

The techniques and theories that have been developed in previous sections and chapters can be applied to practical problems in which the maximum or minimum value of a quantity is required.

Problems that require the use of this theory can be found in many real life situations: manufacturers wanting to minimize their costs, designers wanting to maximize the available space to be used (under specific constraints), farmers wanting to maximize the area of a paddock at a minimum cost, etc. These types of problems often require the construction of an appropriate function that models a particular situation, from which some optimum quantity can be derived or a critical value found for which this optimum quantity exists. We now consider a number of examples to highlight how differential calculus can be used to solve such problems.

EXAMPLE 21.22

Mirko had won at a raffle ticket draw. His prize was to be land. However he had to work hard for this plot of land. The rules specified that the winner was to be given 60 m of rope with which he could enclose a rectangular plot of land that ran along a straight river. Mirko thought for a while and then, with the rope in hand he mapped out his enclosure using the river bank as one side of his plot. What is the maximum land area that Mirko can enclose?

S
o
I
u
t
i
o
n

The object here is to determine the maximum possible area under the constraint that the total available rope measures 60 m. In order to solve problems such as these we need to introduce variables.

Let the dimensions of this plot of land be x m by y m and let the area enclosed by the rope be given by A m².

Then, we have that $A = xy$ – Eq. (1)

The constraint, that the rope is 60 m long, provides another equation: $2x + y = 60$ – Eq. (2)

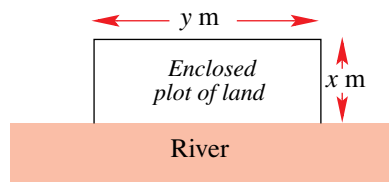

From (2) we have that $y = 60 - 2x$. Then, substituting into (1), we have $A = x(60 - 2x)$.

It is important to realise that we need to express the quantity we wish to optimise in terms of one variable and so, more often than not, we will need two equations: one that defines the quantity that we want to optimise and the second which provides a relationship between the variables that have been introduced.

We also need to determine the implied domain for our function. The physical restrictions are

$$1. x \geq 0 \text{ and } 2. y \geq 0 \Rightarrow 60 - 2x \geq 0 \Leftrightarrow x \leq 30$$

Combining these restrictions we have:

$$A(x) = x(60 - 2x), 0 \leq x \leq 30$$

We are now in a position to determine the stationary points of this function:

$$A(x) = 60x - 2x^2 \Rightarrow A'(x) = 60 - 4x \therefore A'(x) = 0 \Leftrightarrow 60 - 4x = 0 \Leftrightarrow x = 15$$

That is, we have a stationary point at $x = 15$.

MATHEMATICS – Higher Level (Core)

As this value lies inside our domain we now check the nature of this stationary point, i.e., will this critical value provide a maximum or a minimum value of A ?

Using the sign test (of the first derivative) we have:

$$x = 15, A'(15) = 0$$

$$x > 15 \text{ (say } x = 15.1), A'(15.1) = -0.4 < 0.$$

$$x < 15 \text{ (say } x = 14.9), A'(14.9) = 0.4 > 0.$$

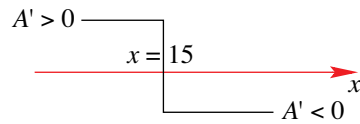

Using the sign of the first derivative we confirm that there exists a local maximum at $x = 15$.

$$\text{So, when } x = 15, A = 15 \times (60 - 2 \times 15) = 450.$$

That is, the maximum area that Mirko can enclose is 450 m^2 .

A graph of the area function can verify this result.

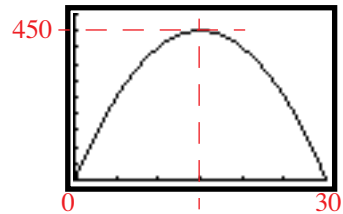

EXAMPLE 21.23

The points PQR form the corner of a house, where angle PQR is a right angle. Running parallel to these walls is a garden patch. There is only 20 metres of fencing available to create the enclosure PUTSRQ, where $PU = RS = x$ and $PQ = QR = y$.

- Express ST in terms of x and y .
- Find an expression for y in terms of x .
- What area does this garden patch cover (give your answer in terms of x)?
- Find the maximum area enclosed by this fence and the walls. Justify your answer.

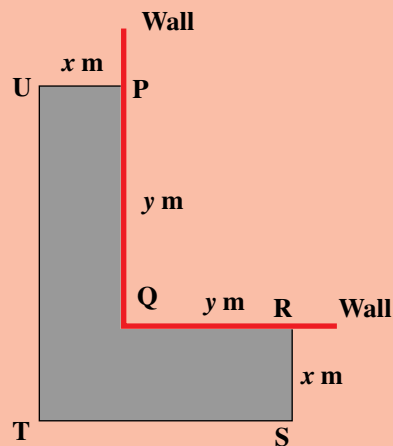

Solution

- $ST = UP + QR = x + y$.
- There is 20 m of fencing available, therefore, $PU + UT + TS + SR = 20$

That is,

$$2x + 2(x + y) = 20$$

and so

$$y = 10 - 2x \text{ - Eq.1.}$$

Note: As $y \geq 0 \Rightarrow 10 - 2x \geq 0 \Leftrightarrow x \leq 5$. We must also have that $x \geq 0$.

That is, there is a restriction on x , namely $0 \leq x \leq 5$.

- The required area, $A \text{ m}^2$, is found by breaking the area into three sections. So that $A = xy + xy + x^2$

$$= 2xy + x^2$$

$$= 2x(10 - 2x) + x^2, \text{ given that } y = 10 - 2x$$

$$= 20x - 3x^2$$

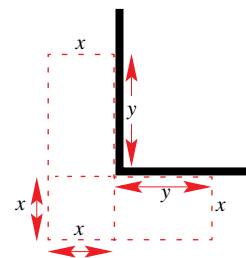

Therefore, we have that $A = 20x - 3x^2, 0 \leq x \leq 5$

(d) To find stationary points we first determine $\frac{dA}{dx} = 20 - 6x$

Then, solve $\frac{dA}{dx} = 0 \Leftrightarrow 20 - 6x = 0 \Leftrightarrow x = \frac{10}{3}$.

Using the sign test we see that a local maximum does occur at $x = \frac{10}{3}$.

(Note: For $x = 0, A = 0$ and for $x = 5, A = 25$.)

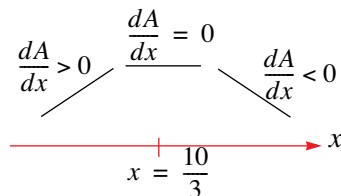

Substituting $x = \frac{10}{3}$ into the area equation, we have that the maximum area in

square metres is $A = 20\left(\frac{10}{3}\right) - 3\left(\frac{10}{3}\right)^2 = \frac{100}{3}$.

Note that in this problem we did not make use of the function A to determine the domain. If we had only considered $A = 20x - 3x^2$ and then solved for $A \geq 0$, (i.e., make the assumption that an area is always positive) we would have obtained the inequalities

$20x - 3x^2 \geq 0 \Leftrightarrow x(20 - 3x) \geq 0 \Leftrightarrow 0 \leq x \leq \frac{20}{3}$. However, it would not be possible for

$x = \frac{20}{3}$, for even at the extreme where $y = 0$, the largest value x can have is 5. [Which

depicts the situation where the garden patch is a square with a vertex making contact with the corner of the walls PQ and QR].

EXAMPLE 21.24

A rectangular sheet of cardboard measures 10 cm by 7 cm. Small squares of equal area are cut from each of the four corners of the sheet. The remaining sides are then folded to form an open box. Find the maximum volume that the box can have.

S We start by drawing a diagram in the hope that it will help us introduce appropriate variables.
I From the diagram it seems reasonable that we
u should have variables to represent the dimensions
t of the box. This seems even more appropriate, given
i that we want to maximise the volume of the box, and
o in order to determine the volume we will need the
n width, length and height of the box.

If we let the side length of the squares that are being cut out be x cm, then the length of the remaining sides will be of length $(7 - 2x)$ cm and $(10 - 2x)$ cm. We then complete our diagram by folding the sheet into an open box. Note that the length x cm on the original rectangular sheet becomes the height of the box.

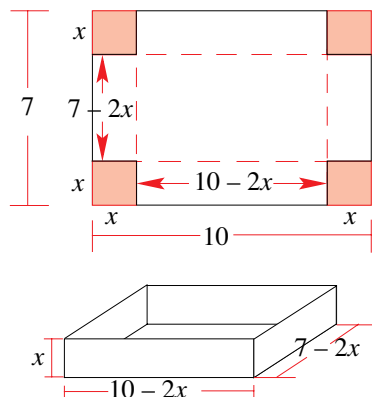

The next step is to decide what values of x we can use – i.e. we need to find the largest possible domain. This is usually done by considering the physical restrictions that are placed on the variables. In this case, all we know is that the lengths must be greater than (or equal to) zero.

MATHEMATICS – Higher Level (Core)

- Looking at each dimension we have:
1. $x \geq 0$
 2. $10 - 2x \geq 0 \Leftrightarrow 10 \geq 2x \Leftrightarrow x \leq 5$
 3. $7 - 2x \geq 0 \Leftrightarrow 7 \geq 2x \Leftrightarrow x \leq 3.5$

Therefore, the largest set of values for x that satisfy all three inequalities is $0 \leq x \leq 3.5$.

Now that we have the domain we need to find an expression for the volume, call it $V \text{ cm}^3$.

As the volume of a box is given by length \times width \times height we have:

$$\begin{aligned} V(x) &= (10 - 2x) \times (7 - 2x) \times x \\ &= 4x^3 - 34x^2 + 70x \end{aligned}$$

And so, our volume function is defined by

$$V(x) = 4x^3 - 34x^2 + 70x, 0 \leq x \leq 3.5$$

Next we search for turning points, i.e., we need to find those values of x for which $V'(x) = 0$.

So, $V'(x) = 12x^2 - 68x + 70$

Then, $V'(x) = 0 \Leftrightarrow 12x^2 - 68x + 70 = 0 \Leftrightarrow x = \frac{68 \pm \sqrt{(-68)^2 - 4 \times 12 \times 70}}{2 \times 12}$

$$= \frac{68 \pm \sqrt{1264}}{24}$$

Then, as $0 \leq x \leq 3.5$ we have to choose $x = \frac{68 - 4\sqrt{79}}{24} \approx 1.3519$

Next, we determine the nature of this turning point. We do this by using the second derivative:

$$V''(x) = 24x - 68 \therefore V''(1.3519) = -35.553 < 0 \Rightarrow \text{local maximum at } x = 1.3519$$

We also need to check the end points, i.e., we need to find $V(0) = 0$ and $V(3.5) = 0$. So, the local maximum is also the absolute maximum.

Therefore, the maximum volume is given by

$$V(1.3519) = 4(1.3519)^3 - 34(1.3519)^2 + 70(1.3519) = 42.3765 \approx 42.38 \text{ (to 2 d.p.)}$$

Obviously, Example 21.24 required a fair amount of work, so we now look at how it could have been solved using a graphics calculator. Note however, the difficult part of the problem is finding the expression for the volume and the restrictions on x . The rest of the solution is fairly standard.

Using the TI-83, we first enter the equation $Y_1 = 4X^3 - 34X^2 + 70X$, use the domain $[0, 3.5]$ and then based on a sketch of the graph, we use the **fMax**(function from the **MATH** menu:

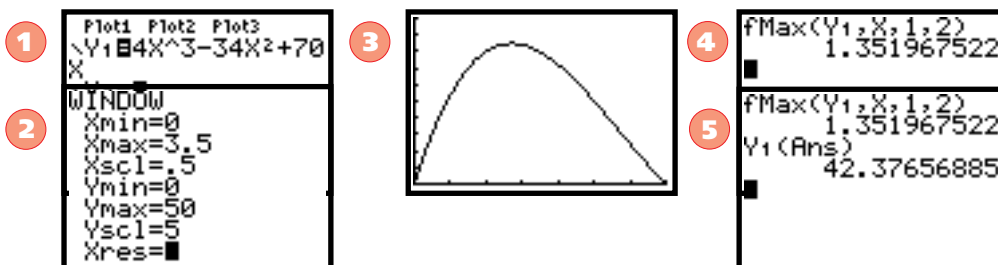

Five rather easy steps! However, often we are asked to find exact values, and a graphics calculator might not be able to provide such results, e.g., if the exact answer happens to be $\sqrt{20} - 4$, it

might only be able to quote the answer as 0.47213. . . And so, to provide exact answers, we must develop our skills in solving such problems by classical means.

EXAMPLE 21.25

Find the point on the curve $y = x^2$ that is closest to the point $(10,0)$.

**S
o
l
u
t
i
o
n**

We start by drawing a diagram:

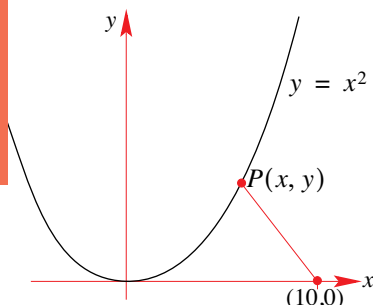

Consider some point $P(x, y)$ on the curve $y = x^2$.

By closest, we mean the shortest distance from the point P to the point $(10,0)$.

In this case we use the formula for the distance between two

points: $L = \sqrt{(x_2 - x_1)^2 + (y_2 - y_1)^2}$,

where L is the distance from (x_1, y_1) to (x_2, y_2) .

Using the points $P(x, y)$ and $(10,0)$ we have:

$$\begin{aligned} L &= \sqrt{(x - 10)^2 + (y - 0)^2} \\ &= \sqrt{(x - 10)^2 + y^2} \end{aligned}$$

However, we know that $y = x^2$ (as P lies on the curve). Therefore the distance from P to $(10,0)$ (in terms of x) is given by

$$\begin{aligned} L &= \sqrt{(x - 10)^2 + (x^2)^2} = \sqrt{(x - 10)^2 + x^4} \\ \therefore L &= (x^2 - 20x + 100 + x^4)^{1/2} \end{aligned}$$

Differentiating, we have: $\frac{dL}{dx} = \frac{1}{2}(2x - 20 + 4x^3)(x^2 - 20x + 100 + x^4)^{-1/2}$

$$= \frac{(x - 10 + 2x^3)}{\sqrt{x^2 - 20x + 100 + x^4}}$$

For stationary points we have $\frac{dL}{dx} = 0 \Rightarrow \frac{(x - 10 + 2x^3)}{\sqrt{x^2 - 20x + 100 + x^4}} = 0 \Leftrightarrow x - 10 + 2x^3 = 0$.

We make use of a graphics calculator.

In this instance we sketch the graph

of $y = x - 10 + 2x^3$ and then we can

concentrate on where it crosses the x -axis:

Using the **TRACE** function on the TI-83, we see that the intercept occurs where $x \approx 1.6$.

Or, we could have simply used the **Solve** function on the TI-83

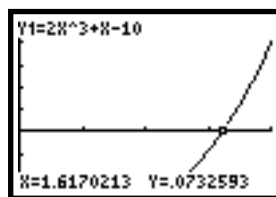

Notice:

Using the **CALC** function and **Zero** subcommand we obtain the value $x = 1.612$.

Now, use the sign of the first derivative to check the nature of the stationary point:

$$\left. \begin{array}{l} x = 1.8 \quad \frac{dL}{dx} > 0 \\ x = 1.4 \quad \frac{dL}{dx} < 0 \end{array} \right\} \therefore \text{we have a local maximum at } x = 1.6$$

Therefore, the point on the curve $y = x^2$ that is closest to the point $(10,0)$ is $(1.6, 2.56)$.

Note that the x -value is provided to only one decimal place. Using $x = 1.6126$, $y = 2.600$.

MATHEMATICS – Higher Level (Core)

There is a very important observation to be made with Example 21.25. When we are looking to find the minimum value of $L = \sqrt{x^2 - 20x + 100 + x^4}$, rather than finding the critical value(s) of L , we could in fact find the critical values of L^2 . **The critical values of L and L^2 will be the same!**

Note: The values of L and L^2 are not the same, only their critical values are.

We verify this now. $L = \sqrt{x^2 - 20x + 100 + x^4} \therefore L^2 = x^2 - 20x + 100 + x^4$.

Then,
$$\frac{d}{dx}(L^2) = 2x - 20 + 4x^3$$

So that, $\frac{d}{dx}(L^2) = 0 \Leftrightarrow 2x - 20 + 4x^3 = 0 \Leftrightarrow x - 10x + 2x^3 = 0$, which will produce the same solutions as when we solved for $\frac{dL}{dx} = 0$. Using this approach is much quicker (and neater).

We can show why this will always work for functions of the form $y = \sqrt{f(x)}$.

Using $y = \sqrt{f(x)}$:

$$\frac{dy}{dx} = \frac{1}{2} \times f'(x) \times \frac{1}{\sqrt{f(x)}} = \frac{f'(x)}{2\sqrt{f(x)}} \therefore \frac{dy}{dx} = 0 \Leftrightarrow \frac{f'(x)}{2\sqrt{f(x)}} \Leftrightarrow f'(x) = 0$$

Using $y^2 = f(x)$:

$$\frac{d}{dx}(y^2) = f'(x) \therefore 2y \frac{dy}{dx} = f'(x) \Leftrightarrow \frac{dy}{dx} = \frac{f'(x)}{2y} \therefore \frac{dy}{dx} = 0 \Leftrightarrow \frac{f'(x)}{2y} = 0 \Leftrightarrow f'(x) = 0.$$

That is, in both instances we solve the same equation, namely, $f'(x) = 0$.

EXAMPLE 21.26

In the lead up to the Christmas shopping period, a toy distributor has produced the following cost and revenue models for one of his toys.

$$\text{Cost: } C(x) = 2.515x - 0.00015x^2, 0 \leq x \leq 6500,$$

$$\text{Revenue: } R(x) = 7.390x - 0.0009x^2, 0 \leq x \leq 6500,$$

where x is the number of units produced.

What is the maximum profit that the distributor can hope for using these models?

Solution

The profit is found by determining the Cost – Revenue, so, letting \$ $P(x)$ denote the profit made for producing x units, we have

$$\begin{aligned} P(x) &= R(x) - C(x) \\ &= (7.390x - 0.0009x^2) - (2.515x - 0.00015x^2) \\ &= 4.875x - 0.00075x^2 \end{aligned}$$

To find the maximum value of $P(x)$, we first need to find the critical value(s) of $P(x)$:

$$\text{Now, } P'(x) = 4.875 - 0.0015x \therefore P'(x) = 0 \Leftrightarrow 4.875 - 0.0015x = 0 \Leftrightarrow x = \frac{4.875}{0.0015} = 3250.$$

$$\text{So, when } x = 3250, P(3250) = 4.875(3250) - 0.00075(3250)^2 = 7921.875.$$

Using the second derivative to check the nature of this turning point, we have:

$P''(x) = -0.0015$ and so, as $P''(x) < 0$ for all $x \in [0, 6500]$ we have a local maximum at $(3250, 7921.875)$ and so, the maximum profit the distributor will make is $\$7921.875 \approx \7922

Once again, we solve the previous example using a graphics calculator.

We enter the cost function as Y_1 , the revenue function as Y_2 and the profit function as

$Y_3 = Y_2 - Y_1$. The rest follows:

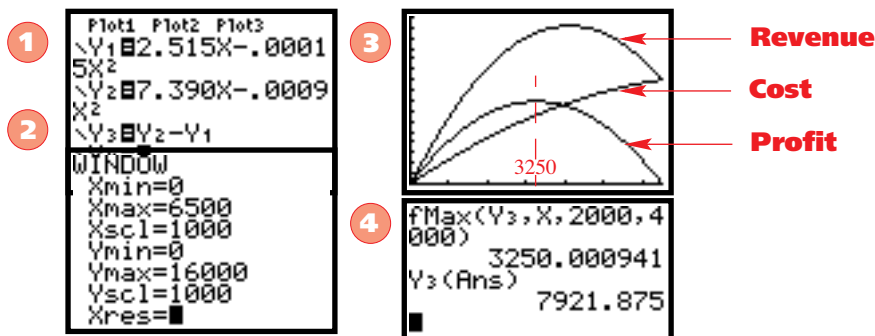

EXAMPLE 21.27

Two heavy industrial plants are located 12 kilometres apart. It is found that the concentration of particulate matter in parts per million in the pollution created at a plant varies as the reciprocal of the square of the distance from the source. If plant 1 emits eight times the particulate matter of plant 2, the combined concentration, C , of particulate matter at any point between the two plants is found to be modelled by $C(x) = \frac{8}{x^2} + \frac{1}{(12-x)^2}$, $0.5 \leq x \leq 11.5$.

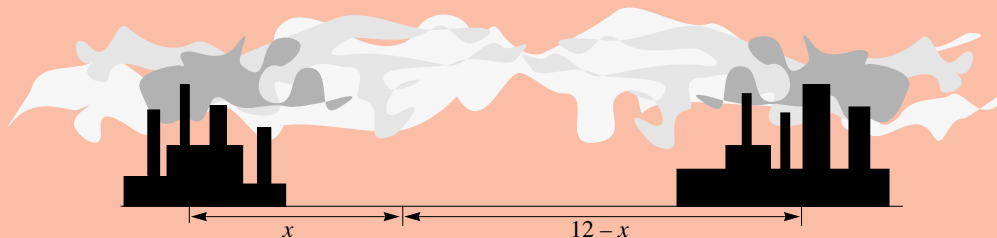

What is the minimum concentration of particulate matter that there can be between the two plants? How far from Plant 1 will this occur?

S
o
l
u
t
i
o
n

We need to determine where the stationary points occur, that is, we solve for $C'(x) = 0$.

$$\text{Now, } C(x) = \frac{8}{x^2} + \frac{1}{(12-x)^2} = 8x^{-2} + (12-x)^{-2} \Rightarrow C'(x) = -16x^{-3} + 2(12-x)^{-3}$$

$$\text{Next, } C'(x) = 0 \Rightarrow -16x^{-3} + 2(12-x)^{-3} = 0 \Leftrightarrow -\frac{16}{x^3} + \frac{2}{(12-x)^3} = 0$$

$$\Leftrightarrow \frac{2}{(12-x)^3} = \frac{16}{x^3}$$

$$\Leftrightarrow \frac{x^3}{(12-x)^3} = 8$$

Taking the cube root of both sides we have:

$$\frac{x}{(12-x)} = 2 \Leftrightarrow 24 - 2x = x$$

$$\Leftrightarrow 3x = 24$$

$$\Leftrightarrow x = 8$$

That is, there is only one stationary point, at $x = 8$. Next we need to check the nature of this stationary point:

Sign of the first derivative:

$$\left. \begin{array}{l} x = 7 \quad C'(7) = -\frac{16}{343} + \frac{2}{125} = -0.03 \\ x = 9 \quad C'(9) = -\frac{16}{729} + \frac{2}{27} = 0.05 \end{array} \right\}$$

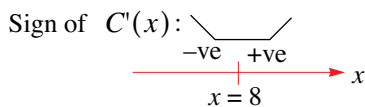

Therefore we have a local minimum at $x = 8$.

To find the minimum concentration we substitute $x = 8$ in the concentration equation.

Minimum concentration is $C(8) = \frac{8}{(8)^2} + \frac{1}{(12-8)^2} = \frac{8}{64} + \frac{1}{16} = \frac{3}{16}$.

So the minimum concentration is $\frac{3}{16}$ parts per million and occurs 8 km from Plant 1.

EXAMPLE 21.28

A non-uniform metal chain hangs between two walls. The height above ground level of this chain is given by the equation

$$h(x) = e^{-2x} + e^x, 0 \leq x \leq 2,$$

where x is the distance along the ground from the left wall.

How close to the ground will the chain get?

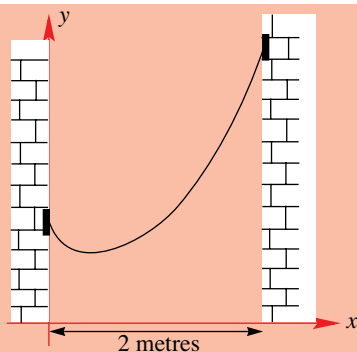

**S
o
l
u
t
i
o
n**

We start by finding the critical values:

$$h(x) = e^{-2x} + e^x \Rightarrow h'(x) = -2e^{-2x} + e^x$$

Now,

$$h'(x) = 0 \Rightarrow -2e^{-2x} + e^x = 0$$

$$\Leftrightarrow 2e^{-2x} = e^x$$

$$\Leftrightarrow \frac{2}{e^{2x}} = e^x$$

$$\Leftrightarrow 2 = e^{3x}$$

$$\Leftrightarrow 3x = \log_e 2$$

$$\Leftrightarrow x = \frac{1}{3} \log_e 2 (\approx 0.23)$$

Checking the nature of this stationary point (using the second derivative) we have:

$$h''(x) = 4e^{-2x} + e^x \therefore h''\left(\frac{1}{3} \log_e 2\right) = 4e^{-2 \times \frac{1}{3} \log_e 2} + e^{\frac{1}{3} \log_e 2} = 4 \times 2^{-2/3} + 2^{1/3} \approx 3.8 > 0$$

Therefore there is a local minimum point at $x = \frac{1}{3} \log_e 2$.

To find how close to the ground the chain gets we substitute this value into the equation:

$$h\left(\frac{1}{3} \log_e 2\right) = e^{-2 \times \frac{1}{3} \log_e 2} + e^{\frac{1}{3} \log_e 2} = 2^{-2/3} + 2^{1/3} \approx 1.89$$

Therefore the chain comes within 1.89 metres of the ground.

EXAMPLE 21.29

A box is to be constructed in such a way that it must have a fixed volume of 800 cm^3 and a square base. If the box is to be open ended at one end, find the dimensions of the box that will require the least amount of material.

S
o
l
u
t
i
o
n

Let the square base have side lengths $x \text{ cm}$ and the let the height be $h \text{ cm}$.

Therefore the volume of the box is $x^2h \text{ cm}^3$.

As the volume is 800 cm^3 , we have $x^2h = 800$ – Eq. 1.

Next we denote the surface area of the box by $S \text{ cm}^2$.

Therefore $S = x^2 + 4xh$ – Eq. 2.

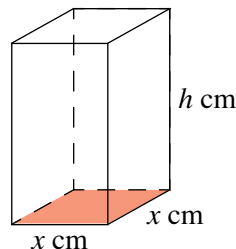

We wish to minimize S , therefore we need to find the critical point(s) of S . However, we must first obtain an expression for S in terms of x (exclusively).

From Eq. 1., we have that $h = \frac{800}{x^2}$ – Eq. 3.

Substituting Eq. 3. into Eq. 2. we have $S(x) = x^2 + 4x \times \frac{800}{x^2} = x^2 + \frac{3200}{x}$

Differentiating, we have, $S'(x) = 2x - \frac{3200}{x^2}$

For stationary points we need to solve $S'(x) = 0$, i.e., $2x - \frac{3200}{x^2} = 0 \Leftrightarrow 2x = \frac{3200}{x^2}$

$$\Leftrightarrow x^3 = 1600$$

$$\Leftrightarrow x = \sqrt[3]{1600} (\approx 11.70)$$

Next, we check the nature of the stationary point.

For $x = 12$, $S'(12) > 0$ and for $x = 11$, $S'(11) < 0$.

Therefore there is a local minimum at $x = 11.70$ and the amount of material required is least when $x = 11.70$ and $h = 5.85$.

EXAMPLE 21.30

A fisherman needs to go by the quickest route from pier A on one side of a strait to pier B on the other side of the strait. The fisherman can get across the strait at 8 km/hr and then run on land at 10 km/hr . Assuming that the banks of the strait are parallel straight lines, 12 km apart and pier B is 26 km along the bank from pier A, where should the fisherman aim to land on the other side of the strait to get to pier B as fast as possible?

S
o
l
u
t
i
o
n

In this problem we assume that the person is moving in a straight line. so, we start by drawing a diagram to represent this situation:

Next we introduce appropriate variables:

Let the fisherman land at Y, $y \text{ km}$ down the river after having travelled $x \text{ km}$ in the river from A to Y.

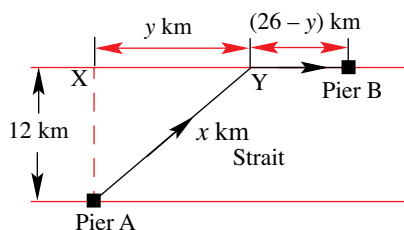

As we are looking for “*as fast as possible*.” we will need to derive an expression for the time

MATHEMATICS – Higher Level (Core)

taken to get from A to B. The journey is from A to Y and then from Y to B. Therefore, the total time taken is the time taken to get from A to Y plus the time taken to get from Y to B. Letting the total time taken be T hr, we have that $T = \frac{AY}{8} + \frac{YB}{10}$.

Now, $AY = x$ and $YB = 26 - y$, therefore, $T = \frac{x}{8} + \frac{26 - y}{10}$.

To proceed any further we will need to express y in terms of x . So, using Pythagoras's Theorem on $\triangle AXY$ we have: $x^2 = (AX)^2 + (XY)^2 \therefore x^2 = 12^2 + y^2 \therefore y = \sqrt{x^2 - 144}$ (as $y \geq 0$)

We now have a function for the time, T hr, in terms of one variable, x . Before we continue, we need to find the largest domain possible so that T is well defined. The smallest value of x occurs if the fisherman crosses straight to X, so that, $x \geq 12$. The largest value of x occurs if the fisherman heads straight to B and so, $x \leq \sqrt{12^2 + 26^2} = 2\sqrt{205}$.

We then have
$$T(x) = \frac{x}{8} + \frac{26 - \sqrt{x^2 - 144}}{10}, 12 \leq x \leq 2\sqrt{205}.$$

To locate the critical values we solve $T'(x) = 0$:

$$\begin{aligned} T'(x) &= \frac{1}{8} + \left[-\frac{1}{10} \times \frac{1}{2} \times 2x \times \frac{1}{\sqrt{x^2 - 144}} \right] \\ &= \frac{1}{8} - \frac{x}{10\sqrt{x^2 - 144}} \end{aligned}$$

Then, $T'(x) = 0 \Leftrightarrow \frac{1}{8} - \frac{x}{10\sqrt{x^2 - 144}} = 0 \Leftrightarrow \frac{x}{\sqrt{x^2 - 144}} = \frac{10}{8} \Leftrightarrow 4x = 5\sqrt{x^2 - 144}$

Solving for x we have:

$$16x^2 = 25(x^2 - 144) \Leftrightarrow 9x^2 = 25 \times 144 \Leftrightarrow x = \pm \sqrt{\frac{25 \times 144}{9}} = \pm \frac{5 \times 12}{3} = \pm 20$$

As $x \geq 12$ this means that the only valid solution is $x = 20$.

Using a sign diagram for $T'(x)$ we have:

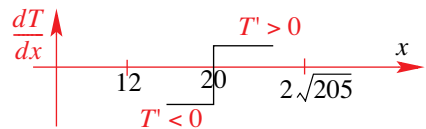

From the graph of $T(x)$ we can also see that the minimum time occurs when $x = 20$.

Therefore, $y = \sqrt{20^2 - 144} = 16$.

The fisherman should land 10 km from the pier.

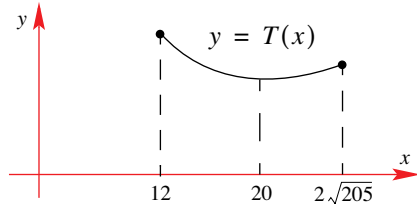

EXAMPLE 21.31

A tourist decides to take a photo of a statue, 12 metres tall on a pillar that is also 12 metres tall. How far from the base of the pillar should the tourist stand so as to have the statue subtend the largest possible angle at their camera lens. You may assume that the camera is held at 1.70 metres above the horizontal and level ground.

Solution

We start by drawing a diagram and letting the statue subtend an angle θ at the lens of the camera. Let the camera be x m from the foot of the pillar.

From the diagram we have that

$$\tan \alpha = \frac{24 - 1.7}{x} = \frac{22.3}{x} \quad \text{Eq. (1)}$$

$$\tan \beta = \frac{12 - 1.7}{x} = \frac{10.3}{x} \quad \text{Eq. (2)}$$

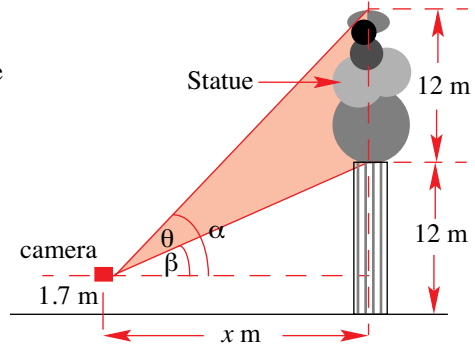

Then, to find an expression for θ we use the identity $\tan \theta = \tan(\alpha - \beta) = \frac{\tan \alpha - \tan \beta}{1 + \tan \alpha \tan \beta}$.

Substituting the results of Eq. (1) and Eq. (2) we have:

$$\tan \theta = \frac{\frac{22.3}{x} - \frac{10.3}{x}}{1 + \left(\frac{22.3}{x}\right)\left(\frac{10.3}{x}\right)} = \frac{\frac{12}{x}}{1 + \frac{229.69}{x^2}} = \frac{\frac{12}{x}}{\frac{x^2 + 229.69}{x^2}} = \frac{12x}{x^2 + 229.69}$$

This provides us with an implicit function for θ in terms of x . So, differentiating both sides with respect to x , we have:

$$\begin{aligned} \frac{d}{dx}(\tan \theta) &= \frac{d}{dx} \left[\frac{12x}{x^2 + 229.69} \right] \therefore \sec^2 \theta \times \frac{d\theta}{dx} = \frac{12(x^2 + 229.69) - 12x(2x)}{(x^2 + 229.69)^2} \\ &= \frac{2756.28 - 12x^2}{(x^2 + 229.69)^2} \end{aligned}$$

Solving for $\frac{d\theta}{dx} = 0$ we have $\frac{2756.28 - 12x^2}{(x^2 + 229.69)^2} = 0 \Leftrightarrow 12x^2 = 2756.28 \Leftrightarrow x^2 = 229.69$.

What happened to the “ $\sec^2 \theta$ ” term?

Now, as $x \geq 0$, $x = \sqrt{229.69} = 15.155\dots \approx 15.16$.

That is, the tourist must stand 15.16 metres from the foot of the pillar in order to obtain the largest possible angle, which subtends the statue at their camera lens.

This time we will not use the sign test of the first or second derivative to check the nature of this stationary point but rather look at the relevant graph.

In this case, sketching the graph of $\tan \theta$ vs x as opposed to θ vs x will not make any difference in determining the critical value of θ . In this instance we deal with the graph of $\tan \theta$ vs x as this is the easier option. Otherwise we would need to sketch the graph of $\theta = \arctan\left(\frac{12x}{x^2 + 229.69}\right)$.

So, let's treat $\tan \theta$ as the variable T (say) and then sketch the graph of T vs x where

$$T = \frac{12x}{x^2 + 229.69}, x \geq 0.$$

Why does this work? Would the same thing apply if we had been using the expression

$$\sin \theta = \frac{12x}{x^2 + 229.69} \quad \text{or} \quad \cos \theta = \frac{12x}{x^2 + 229.69} \quad ? \quad \text{What about } \ln(\theta) = \frac{12x}{x^2 + 229.69} \quad ?$$

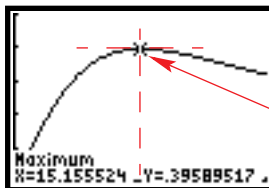
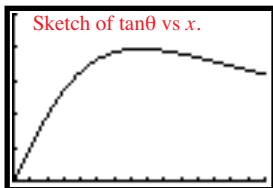
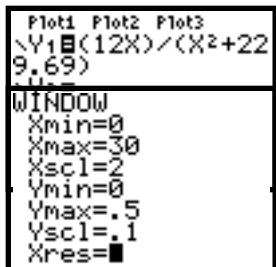

From the graph it is clear that the maximum occurs at $x \approx 15.16$

Notice that when $x = 15.61$, $\tan \theta = 0.3958$, so that $\theta = \arctan(0.3958) = 21.59^\circ$. That is, the angle which the statue subtends at the camera lens when $x = 15.61$ is 21.59° . Had we sketched the graph of θ vs x , then the shape of the graph would be the same but the y -values would differ, in fact, at $x = 15.16$, we would have a θ -value of 0.3769 radians (which is equal to 21.59°).

21.5.2 END POINT MAXIMA/MINIMA PROBLEMS

So far we have dealt with problems that involved locating the stationary point via setting the first derivative to zero, solving and then verifying the nature of the stationary point (or turning point). We now consider, as we did in §20.4.3, problems where locating stationary points using our standard approach might only provide a local optimum whereas in fact, the optimum might exist at an endpoint. We now illustrate how to solve such questions.

EXAMPLE 21.32

A square sheet of cardboard of side length 12 cm has squares of side length x cm cut from each corner so that the remainder can be folded to form an open box. The four squares are then put together to form a hollow box (that is, open at both ends).

Show that the combined volume of the boxes, $V(x)$ cm³, is given by

$$V(x) = 4x(6 - x)^2 + x^3, 0 \leq x \leq 6.$$

Hence find the maximum possible volume.

S
O
L
I
T
I
O
N

We start by drawing a diagram to help us visualise the situation.

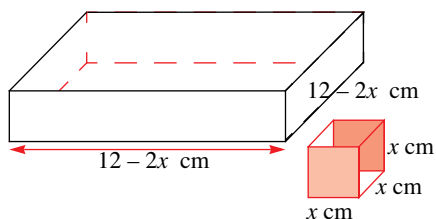
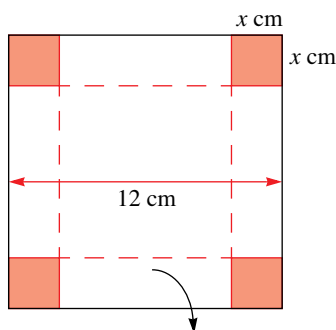

From the diagram, we have the combined volume

$$\begin{aligned} V(x) &= x(12 - 2x)(12 - 2x) + x^3 \\ &= x \times 2(6 - x) \times 2(6 - x) + x^3 \\ &= 4x(6 - x)^2 + x^3 \end{aligned}$$

Now, as a length cannot be negative, we must have that $x \geq 0$ and $12 - 2x \geq 0$ so that $0 \leq x \leq 6$.

Therefore, $V(x) = 4x(6 - x)^2 + x^3, 0 \leq x \leq 6$ as required.

Next, to determine the maximum volume, the normal course of action would be to find the stationary points, i.e., solve for $V'(x) = 0$.

$$\begin{aligned} \text{Now, } V(x) &= 4x(6 - x)^2 + x^3 = 5x^3 - 48x^2 + 144x \\ \therefore V'(x) &= 15x^2 - 96x + 144 \end{aligned}$$

Setting $V'(x) = 0$ we have $15x^2 - 96x + 144 = 0 \Leftrightarrow x = 4$ or $x = 2.4$.

Using the sign of the first derivative we find that;

at $x = 4$ we have a local minimum,

at $x = 2.4$ we have a local maximum.

Now, $V(4) = 128$ and $V(2.4) = 138.24$, leading us to believe that the maximum volume would be 138.24 cm^3 .

However, the graph of the function $V(x) = 4x(6-x)^2 + x^3$, $0 \leq x \leq 6$, tells a different story:

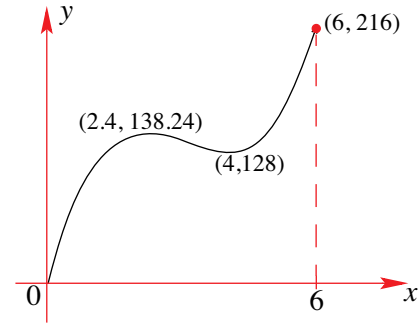

From the graph, it is clear that the maximum volume is in fact 216 cm^3 and not 138.24 cm^3 (as was thought).

This is an example of an **end-point maximum**.

This highlights the importance of the restrictions placed on the domain. For example, if the problem had been to find the maximum value of $V(x)$, where

$$V(x) = 4x(6-x)^2 + x^3, 0 \leq x \leq 4,$$

then, the maximum value would have been 138.24 cm^3 .

EXAMPLE 21.33

Two shops, A and B linked by a straight road, R1, are 4 kilometres apart. A second straight road, R2, bisects R1 at right angles. One kilometre along R2 from where it bisects R1 a third shop, C, can be found. A bus stop is to be placed on R2, somewhere between shop C and R1. Where should the bus stop be placed so that the sum of the direct distances from the shops to the bus stop is a minimum?

S
o
l
u
t
i
o
n

Let P be the location of the bus stop and x km the distance from R1 to P along R2. This means that $x \geq 0$ ($x = 0$ if on R1) but $x \leq 1$ ($x = 1$ if at C)

Let the sum of the distances be S km, then,

$$S = AP + PC + BP$$

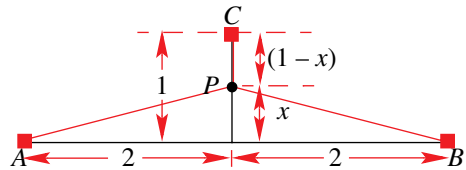

Using Pythagoras's Theorem we have:

$$AP^2 = 2^2 + x^2 \therefore AP = \sqrt{4 + x^2}, \text{ as } AP \geq 0.$$

Similarly, $BP^2 = 2^2 + x^2 \therefore BP = \sqrt{4 + x^2}, \text{ as } BP \geq 0.$

Therefore, $S = 2\sqrt{4 + x^2} + (1 - x), 0 \leq x \leq 1$.

$$\text{Now, } \frac{dS}{dx} = 2 \times \frac{1}{2} \times 2x \times \frac{1}{\sqrt{4 + x^2}} + (-1) = \frac{2x}{\sqrt{4 + x^2}} - 1$$

$$\therefore \frac{dS}{dx} = \frac{2x - \sqrt{4 + x^2}}{\sqrt{4 + x^2}}$$

$$\text{And so, } \frac{dS}{dx} = 0 \Leftrightarrow \frac{2x - \sqrt{4 + x^2}}{\sqrt{4 + x^2}} = 0 \Leftrightarrow 2x - \sqrt{4 + x^2} = 0 \therefore 4x^2 = 4 + x^2$$

$$\text{That is, } 3x^2 = 4 \therefore x = \pm \frac{2}{\sqrt{3}} = \pm \frac{2\sqrt{3}}{3} \approx \pm 1.1547.$$

MATHEMATICS – Higher Level (Core)

However, neither one of these critical values lies in the domain $S (= [0, 1])$. This means that we will need to look at an endpoint minimum.

When $x = 0$, $S = 2\sqrt{4} + (1) = 5$, giving us a maximum.

When $x = 1$, $S = 2\sqrt{4 + 1^2} + (1 - 1) = 2\sqrt{5}$.

Hence, the minimum value of S occurs at $x = 1$ and has a

value of $2\sqrt{5}$ km (approx. 4.47 km). Therefore, bus stop should be placed at stop C.

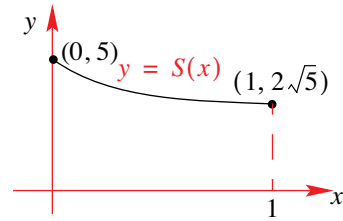

21.5.3 OPTIMISATION FOR INTEGER VALUED VARIABLES

When determining critical values, we do not always place importance on what they end up being. We simply quote an answer without further consideration to what the value is representing. For example, if we want to know how many globes need to be produced in order to maximise the profit, we might quote an answer of 2457.47... where in fact we know that the actual answer can only be an integer. We now consider such a problem – where the variables involved are integers.

EXAMPLE 21.34

Light and Co. purchase plastic components for their printing needs. They estimate that they will be using 800 such components every year. Each time they place an order for these plastic parts it costs them \$22. If they place an order x times per year, then, on average, they store $\frac{400}{x}$ units. Each stored unit costs \$8 to store. How often should they place an order so as to minimise their ordering and storage costs?

Solution

After placing x orders, the company's costs are made up of the ordering cost, \$ $22x$ and the storage cost \$ $\frac{400}{x} \times 8 = \$ \frac{3200}{x}$. We denote this cost by \$ $C(x)$, so that their expenses for

ordering and storage are given by $C(x) = 22x + \frac{3200}{x}$, $x > 0$.

Next we determine the stationary point(s) for the cost function:

$$C'(x) = 22 - \frac{3200}{x^2}, x > 0.$$

$$\text{Setting, } C'(x) = 0 \Rightarrow 22 - \frac{3200}{x^2} = 0 \Leftrightarrow 22 = \frac{3200}{x^2} \Leftrightarrow x^2 = \frac{3200}{22}.$$

As $x > 0$, we choose the positive square root, so that the critical value occurs at $x = \sqrt{\frac{1600}{11}}$.

To check the nature of this stationary point, we use the second derivative: $C''(x) = \frac{6400}{x^3}$.

Then, at $x = \sqrt{\frac{1600}{11}}$, $C''(x) > 0$ and so we have a local minimum at $x = \sqrt{\frac{1600}{11}}$.

However, $x = \sqrt{\frac{1600}{11}} \approx 12.06...$ does not provide us with an integer value, and the company can only make integer valued orders, for example, it cannot make 3.87 orders per year, it must make

either 3 orders or 4 orders. So, we now need to find the minimum value of $C(x)$ for a positive integer – obviously, the positive integer we are looking for will lie in the vicinity of $x = 12.06$.

We now sketch the graph of $C(x)$ for integer values of x :

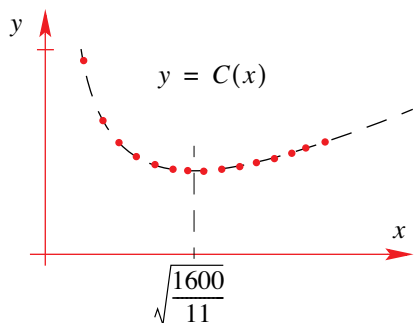

Using a table of values we have:

$$C(11) = 532.91$$

$$C(12) = 530.67$$

$$C(13) = 532.15,$$

and so, the minimum cost occurs when $x = 12$.

X	Y1
8	576
9	553.56
10	540
11	532.91
12	530.67
13	532.15
14	536.57

X=14

Therefore, they should place 12 orders per year in order to minimise their costs.

EXERCISES 21.5

- A ball is thrown upwards and after t seconds reaches a height of h m above the ground. The height of the ball at time t is given by the equation $h = 19.6t - 4.9t^2 + 3$. What is the maximum height that the ball will reach from the ground?
- The running cost, \$ C per kilometre for a new car is modelled by the equation $C = 20 + 0.2v^2 - 0.6v$, where v km/h is the average speed of the car during a trip.

 - At what speed should the car be driven to minimise the running cost per km?
 - What is the minimum running cost per km for this car?
 - Comment on your answers.
- The total revenue, \$ R , that a company can expect after selling x units of its product – GIZMO – can be determined by the equation $R = -x^3 + 510x^2 + 72000x$, $x \geq 0$.

 - How many units should the company produce to maximise their revenue?
 - What is the maximum revenue to be made from the sales of GIZMOs?
- A retailer has determined that the monthly costs, \$ C , involved for ordering and storing x units of a product can be modelled by the function $C(x) = 2.5x + \frac{7500}{x}$, $0 < x \leq 250$.

What is the minimum monthly cost that the retailer can expect? Note that x is an integer value.
- The marketing department at DIBI Ltd. have determined that the demand, at \$ d per unit, for a product can be modelled by the equation, $d = \frac{80}{\sqrt{x}}$, where x is the number of units produced and sold. The total cost, \$ C , of producing x items given by $C = 200 + 0.2x$. What price will yield a maximum profit?

MATHEMATICS – Higher Level (Core)

- 6.** The cross-section of a small hill is modelled by the curve with equation

$$y = \frac{1}{8}x^2 \sin\left(\frac{1}{2}x\right), 0 \leq x \leq 2\pi,$$

where x metres is the horizontal distance from the point O and y metres is the corresponding height. What is the maximum height of the hill?

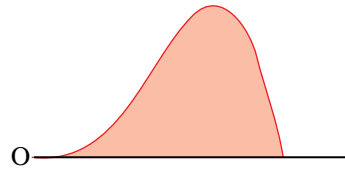

- 7.** A 10 metres long sheet of tin of width 60 centimetres is to be bent to form an open gutter having a rectangular cross-section. Find the maximum volume of water that this 10 metres stretch of guttering can carry.

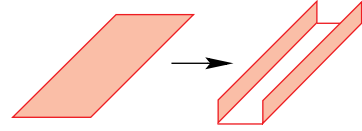

- 8.** A 20 metre long piece of wire is bent into a rectangular shape. Find the dimensions of the rectangle that encloses the maximum area.

- 9.** If $x + y = 8$ find the minimum value of $N = x^3 + y^3$.

- 10.** A swimming pool is constructed as a rectangle and a semicircle of radius r m.

The perimeter of the pool is to be 50 metres. Find the value of r and the dimensions of the rectangular section of the pool if the surface area of the pool is to be a maximum.

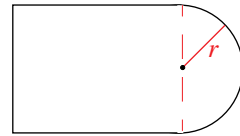

- 11.** A roof gutter is to be made from a long flat sheet of tin 21 cm wide by turning up sides of 7 cm so that it has a trapezoidal cross-section as shown in the diagram.

Find the value of θ that will maximise the carrying capacity of the gutter.

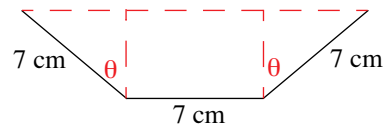

- 12.** At the Happy Place amusement park, there is a roller coaster ride named 'The Not-So-Happy Ride'. A section of this ride has been created using a scaled version of the model

given by the equation $y = \sin x + \frac{1}{2} \sin 2x, 0 \leq x \leq 2\pi$.

- Sketch the graph of this curve.
- What is the maximum drop that this ride provides?
- At what point(s) along the ride will a person come to the steepest part(s) of the ride?

- 13.** A rectangle is cut from a circular disc of radius 18 metres. Find the maximum area of the rectangle.

- 14.** Two real numbers x and y are such that $x + y = 21$. Find the value of x for which

- the product, xy , is a maximum.
- the product xy^3 is a maximum.

- 15.** If $x + y = 12$, find the minimum value that $x^2 + y^2$ can have.

- 16.** A farmer wishes to fence off a rectangular paddock using an existing stretch of a river as one side. The total length of wiring available is 100 m. Let x m and y m denote the length and width of this rectangular paddock respectively, and let A m² denote its area.
- Obtain an expression for y in terms of x .
 - Find an expression for A in terms of x , stating any restrictions on x .
 - Determine the dimensions which will maximize the area of the paddock.

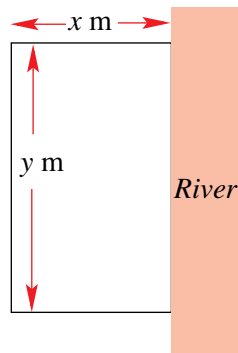

- 17.** A closed rectangular box with square ends is to be constructed in such a way that its total surface area is 400 cm². Let x cm be the side length of the ends and y cm its height.
- Obtain an expression for y in terms of x , stating any restrictions on x .
 - Find the largest possible volume of all such boxes.

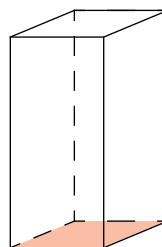

- 18.** A barrel is being filled with water in such a way that the volume of water, V ml, in the barrel after time t seconds is given by

$$V(t) = \frac{2}{3} \left(20t^2 - \frac{1}{6}t^3 \right), 0 \leq t \leq 120.$$

- Find the rate of flow into the barrel after 20 seconds.
 - When will the rate of flow be greatest?
 - Sketch the graph of $V(t)$, $0 \leq t \leq 120$.
- 19.** The total cost, \$ C , for the production of x items of a particular product is given by the linear relation $C = 600 + 20x$, $0 \leq x \leq 100$, whilst its total revenue, \$ R , is given by $R = x(100 - x)$, $0 \leq x \leq 100$.
- Sketch the graphs of the cost function and revenue function on the same set of axes.
 - Determine the break-even points on your graph.
 - For what values of x will the company be making a positive profit?
 - Find an expression that gives the profit made in producing x items of the product and hence determine the maximum profit.

- 20.** Find the points on the graph of $y = 9 - x^2$ that are closest to the point $(0, 3)$.

- 21.** A rectangle is bounded by the semi-circle with equation $y = \sqrt{25 - x^2}$, $-5 \leq x \leq 5$ and the x -axis. Find the dimensions of the rectangle having the largest area.

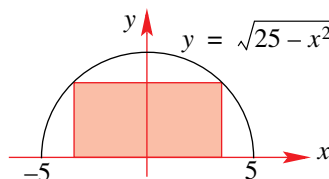

MATHEMATICS – Higher Level (Core)

- 22.** A rectangle is bounded by the positive x -axis the positive y -axis and the line with equation

$$y = \frac{2}{3}(8 - x)$$

Find the dimensions of the rectangle having the largest area.

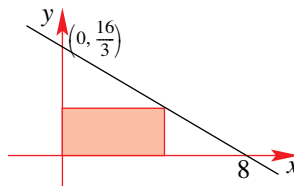

- 23.** A certificate is to be printed on a page having an area of 340 cm^2 . The margins at the top and bottom of the page are to be 2 cm and, on the sides, 1 cm.
- (a) If the width of the page is $x \text{ cm}$, show that the area, $A \text{ cm}^2$ where printed material is to appear is given by $A = 348 - \frac{680}{x} - 4x$.
- (b) Hence, determine the maximum area of print.

- 24.** Find the minimum value of the sum of a positive integer and its reciprocal.

- 25.** A closed circular cylinder is to have a surface area of $20\pi \text{ cm}^2$. Determine the dimensions of the cylinder which will have the largest volume.

- 26.** A right circular cylinder of radius $r \text{ cm}$ and height $h \text{ cm}$ is to have a fixed volume of 30 cm^3 .

- (a) Show that the surface area, $A \text{ cm}^2$ of such a cylinder is given by $A = 2\pi r\left(r + \frac{30}{\pi r^2}\right)$.
- (b) Determine the value of r that will yield the minimum surface area.

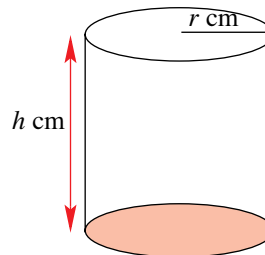

- 27.** A rectangular container is made by cutting out squares from the corners of a 25 cm by 40 cm rectangular sheet of metal and folding the remaining sheet to form the container.

- (a) If the squares that are cut out are $x \text{ cm}$ in length, show that the volume, $V \text{ cm}^3$ of the container is given by

$$V = x(25 - 2x)(40 - 2x), 0 < x < \frac{25}{2}$$

- (b) What size squares must be cut out in order to maximize the volume of the container?

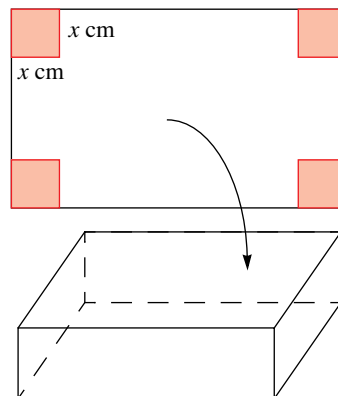

- 28.** A right-circular cone of radius $r \text{ cm}$ contains a sphere of radius 12 cm.

- (a) If the height of the cone is $h \text{ cm}$, express h in terms of r .
- (b) If $V \text{ cm}^3$ denotes the volume of the cone, find an expression for V in terms of r .
- (c) Find the dimensions of the cone with the smallest volume.

- 29.** For a closed cylinder of radius $r \text{ cm}$ and height $h \text{ cm}$, find the ratio $r : h$ which will produce the smallest surface area for a fixed volume.

- 30.** Find the coordinates of the point on the curve with equation $y = x^2 + 1$ that is closest to the point $(2, 0)$.

- 31.** A piece of wire is bent in the form of a sector of a circle of radius r metres containing an angle θ° . The total length of the wire is 10 metres.
- (a) Show that $\theta = \frac{2}{r}(5 - r)$.
- (b) Find the value of r for which the area of this sector is a maximum.
- 32.** Find the altitude of the cylinder with the largest volume that can be inscribed in a right circular cone.
- 33.** A window is designed so that it has an equilateral triangle mounted on a rectangular base. If the perimeter totals 7 metres, what is the maximum area, that will allow the maximum amount of light to pass through the window?
- 34.** A cone is formed by joining the two straight edges of a sector from a circle of radius r . If the angle contained by the two straight edges is α° find the value of α° which makes the volume of the cone a maximum.
- 35.** Two houses in a new housing estate need to have cable connected to a distribution box, P, located somewhere along a straight path XY. House A is located a m from the path while house B is located b m from the path. The cost of installing the cable is \$ $6(AP + BP)$. Where should the box be placed so as to minimise the cost involved?

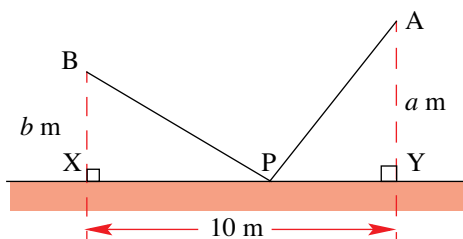

- 36.** Felicity and Jane start walking at the same time towards an intersection of two roads that meet at right angles.

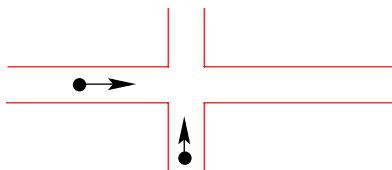

Felicity starts at 9 km from the intersection while Jane starts at 13 km from the intersection. Their speeds are 4 km/h and 3 km/h respectively. What is the closest that Felicity and Jane will get?

- 37.** For an open cylinder of radius r cm and height h cm, find the ratio $r : h$ which will produce the smallest surface area for a fixed volume.
- 38.** Find the height of a right-circular cone which can be inscribed in a sphere of radius 1 m, if this cone is to have the largest possible volume.

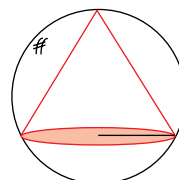

MATHEMATICS – Higher Level (Core)

- 39.** A piece of wire 30 cm long is cut into 2 pieces. One of the pieces is bent into a square while the other is bent into a circle. Find the ratio of the side length of the square to the radius of the circle which provides the smallest area sum.

- 40.** A cylindrical tin with no lid is to be made from a sheet of metal measuring 100 cm^2 . Given that the radius of the base of the tin is $r \text{ cm}$ show that its volume, $V \text{ cm}^3$, is given by

$$V = \frac{1}{2}(100r - \pi r^3)$$

Determine the value of r that will give the greatest volume.

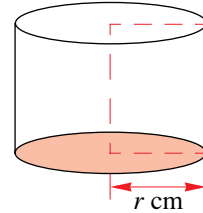

- 41.** The last leg of a triathlon requires that you get from a point O, 2 km from the nearest point P on a straight beach to a point Q, 3 km down the coast.

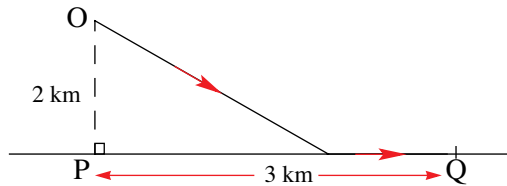

You may swim to any point on the beach and then run the rest of the way to point Q. If you can swim at a rate of 2 km/hr and run at 5 km/hr, where should you land on the beach so that you reach point Q in the least possible time?

- 42.** A right circular cylinder is inscribed in a sphere of radius 6 cm. If α is the angle subtended at the centre of the sphere by the radius of the circular base of the cylinder,
- show that the curved surface area, $S \text{ cm}^2$, of the cylinder is given by $72\pi \sin 2\alpha$;
 - find the radius and height of the cylinder having the largest curved surface area.

- 43.** A person in a boat 4 km from the nearest point P on a straight beach, wishes to get to a point Q 8 km along the beach from P.

The person rows in a straight line to some point on the beach at a constant rate of 5 km/h. Once on the beach the person walks towards Q at a steady rate of 6 km/hr.

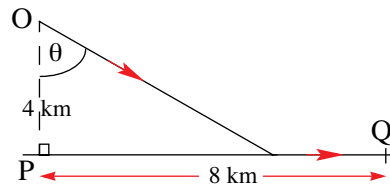

- (a) Show that the total time in hours taken for the trip is

$$T(\theta) = \frac{4 \sec \theta}{5} + \frac{8 - 4 \tan \theta}{6}, \theta \in \left[0, \frac{\pi}{2}\right) \text{ and } \tan \theta \leq 2$$

- (b) Where should the person land so that the trip takes the least amount of time?

- 44.** A mast l metres tall erected on a building k metres tall, subtends an angle θ at a point on the ground x metres from the base.

- Find an expression for $\tan \theta$ in terms of x .
- Find the value of x that maximizes the value of θ .

[Hint: As $\theta \in \left[0, \frac{\pi}{2}\right)$, θ is a maximum when $\tan \theta$ is a maximum.]

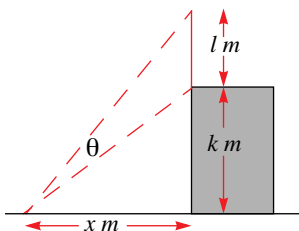

- 45.** A person in a boat l km from the nearest point P on a straight beach, wishes to get to a point Q kl km along the beach from P. The person rows in a straight line to some point on the shore at a constant rate of v km/h. Once on the beach the person walks towards Q at a steady rate of u km/hr where ($v < u$).

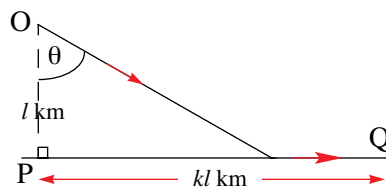

- (a) Show that the total time in hours taken for the trip is

$$T(\theta) = \frac{l \sec \theta}{v} + \frac{kl - l \tan \theta}{u}, \theta \in \left[0, \frac{\pi}{2}\right) \text{ and } \tan \theta \leq k.$$

- (b) Show that if the person is to reach point Q in the least possible time, then $\sin \theta = \frac{v}{u}$ where $k \geq c$, c being a particular constant.
- (c) What would happen if $k < c$?

- 46.** A closed tin is to be constructed as shown in the diagram. It is made up of a cylinder of height h cm and radius base r cm which is surmounted by a hemispherical cap.

- (a) Find an expression in terms of r and h for
- its volume, $V \text{ cm}^3$.
 - its surface area, $A \text{ cm}^2$.
- (b) Given that $V = \pi k^3$, $k > 0$, show that its surface area is given by $A = 2\pi k^3 \frac{1}{r} + \frac{5\pi}{3} r^2$.
- (c) Find the ratio $r : h$ for A to be a minimum.

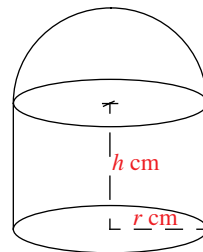

- 47.** A ladder is to be carried horizontally around a corner from a corridor a m wide into a corridor b m wide.

What is the maximum length that the ladder can be?

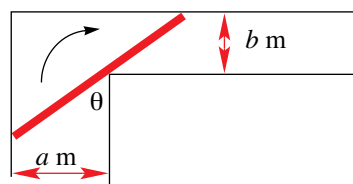

- 48.** A man in a boat is 3 km from the nearest point of a straight beach. The man is to get to a point 6 km along the beach. The man can row at 4 km/hr and walk at 5 km/hr.

- (a) Show that the time, T hours, taken to get to his destination is given by

$$T = \frac{\sqrt{x^2 + 9}}{4} + \frac{6-x}{5}, 0 \leq x \leq 6$$

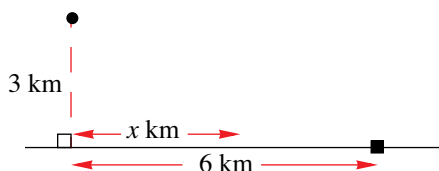

- (b) Where should the man row to along the beach if he is to reach his destination in the least possible time?
- (c) After some further training, the man finds that he can now row at 4.5 km/hr. Where should he now row to along the beach to minimise the time taken?

MATHEMATICS – Higher Level (Core)

- 49.** The relationship between the number of spawners, S , and the number of recruits, R , in a cod farm is modelled by the equation $R = \alpha S 2^{-\beta S}$, $S \geq 0$ and the constants $\alpha > 0$, $\beta > 0$.
- Sketch the graphs of $R = S$ and $R = \alpha S 2^{-\beta S}$ on the same set of axes.
 - For what value of S will the number of spawners first outnumber the number of recruits?
 - Show that the value of S that maximises $(R - S)$ satisfies the equation $2^{\beta S} = \alpha(1 - \beta S \ln 2)$.

- 50.** While cruising the waters, you spot a tower 150 m tall standing on the edge of a vertical cliff 150 m high (from sea level). How far from the base of the cliff should you stand to have the tower subtend the largest possible angle at your camera lens, if the camera is in a position 5 metres above sea level?

- 51.** The point P is joined to the ends of the diameter AB of a circle having a radius r , so that ABP forms a triangle. If P is to always remain on the circumference, what type of triangle will ABP be if

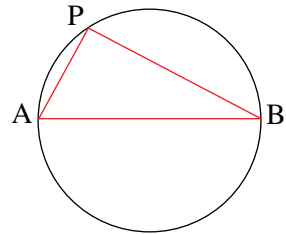

- the area of triangle ABP is a maximum?
- the perimeter of triangle ABP is a maximum?

- 52.** An isosceles triangle ABC , where $AB = AC$ and $\angle BAC = 2\alpha$ is inscribed in a circle of radius r . Show that the area of the triangle ABC is a maximum if $\alpha = \frac{\pi}{6}$. What would the maximum area of the triangle ABC be if $0 < \alpha \leq \frac{\pi}{12}$?

- 53.** A square $PQRS$ of side length 1 m has three points, A , B , C on the sides QR , RS and SP such that $QA = l$ m, $RB = kl$ m and $SC = kl$ m where $0 < l < 1$ and $0 < kl < 1$. If k is a constant, find the minimum value of the area of the quadrilateral $PABC$.

- 54.** A variable isosceles triangle is circumscribed about a given circle of fixed radius r as shown in the diagram.

- State the value of c .
- Show that $b = \frac{r(a+r)}{\sqrt{a^2-r^2}}$.
- Show that the area of the triangle is a minimum when the triangle is equilateral.

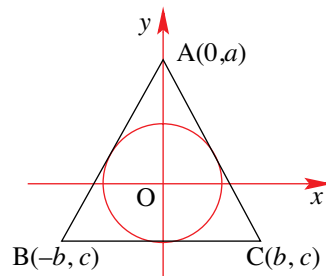

REVISION SET D - PAPER 1 & PAPER 2 STYLE QUESTIONS

- 1.** Differentiate (a) $\sqrt{x^2 + 4}$ (b) $(2x - 1)\cos 2x$
- 2.** A cup of tea, initially at a temperature of 80°C is left to cool. Its temperature, $\theta^\circ\text{C}$, after t minutes is given by $\theta = 20 + 60e^{-0.04t}$, $t \geq 0$.
- (a) How many degrees will its temperature fall in the first 10 minutes?
 (b) At what rate, in degrees per minute, is its temperature falling at the end of 10 minutes?
 (c) How many minutes will it take for its temperature to drop from 80°C to 50°C ?
 (Give all these answers correct to 1 decimal place.)

- 3.** Let the function f be defined by $f(x) = x - 3 + \frac{4}{x^2}$, $x \neq 0$

- (a) Find the values of x for which $f(x) \geq 0$.
 (b) Find the values of x for which $f'(x) \geq 0$.

- 4.** A tree trunk of length 12 metres is a truncated cone, the radii of the ends being 0.30 metres and 0.18 metres. If r metres is the radius of the cross-section at a distance h metres from the wider end, prove that

$$h = 100(0.3 - r)$$

A beam of uniform square cross-section is cut from the tree trunk, the centre line of the beam being along the axis of the cone.

If $V \text{ m}^3$ is the volume of the widest beam of length h metres which can be cut from the trunk, prove that

$$V = 2r^2h.$$

Find the length of the beam of greatest volume which can be cut from the trunk.

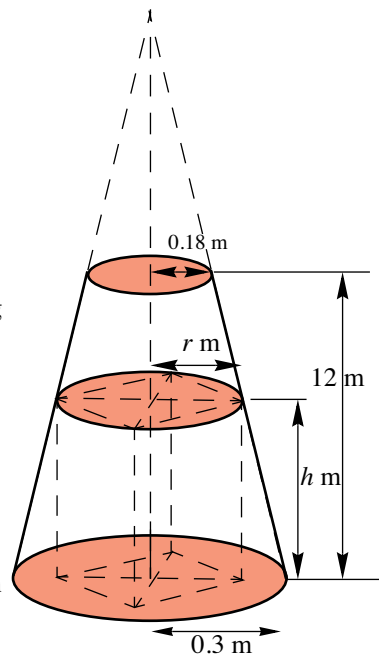

- 5.** Find $f'(x)$ if (a) $f(x) = \frac{x^2 - 1}{x^2 + 1}$ (b) $f(x) = \cos^2 2x$

- 6.** Let $f(x) = \sqrt{x}$ and $g(x) = 4 - x^2$.
- (a) Find i. $f(g(2))$ ii. $g(f(2))$
 (b) State all values of x for which $f(g(x))$ is defined.
 (c) State all values of x for which $g(f(x))$ is defined.
 (d) If $h(x) = f(g(x))$ find $h'(x)$.

MATHEMATICS – Higher Level (Core)

- 7.** Let P and Q be the points on the curve $y = \frac{1}{x^2}$ at which $x = 1$ and $x = 1 + h$ respectively.
- (a) Express the gradient of the line [PQ] in terms of h .
- (b) Hence find the gradient of the tangent to the curve at $x = 1$.
- 8.** A small object is oscillating up and down at the end of a vertical spring. The object is h metres above its starting point at time t seconds, where $h(t) = \frac{1}{2}\left(1 - e^{-0.05t} \cos\left(\frac{3\pi}{2}t\right)\right)$. Find the rate at which the object is rising (or falling) 2.5 seconds after the motion starts.
- 9.** (a) Sketch the graph of $y = 4(x^2 - x^4)$, locating the stationary points and giving their coordinates.
- (b) Sketch on the same set of axes the graph of $y = \frac{1}{4(x^2 - x^4)}$
- Label both graphs clearly.

10. Find $f'(x)$ if i. $f(x) = \sin^3 2x$. ii. $f(x) = \frac{x}{\sqrt{2x+3}}$.

- 11.** (a) Sketch the graph of $y = \frac{1}{9}(4x^3 - x^4)$. Identify all intercepts with the axes and all stationary points, and state their coordinates.
- (b) Find (correct to the nearest degree) the angle at which the graph cuts the positive x -axis.

- 12.** A sheet of cardboard measures 10 cm by 16 cm. Squares x cm by x cm are cut from two corners, and strips x cm by $(x + y)$ cm are cut from two sides, as shown in the diagram. (The shaded regions are removed).

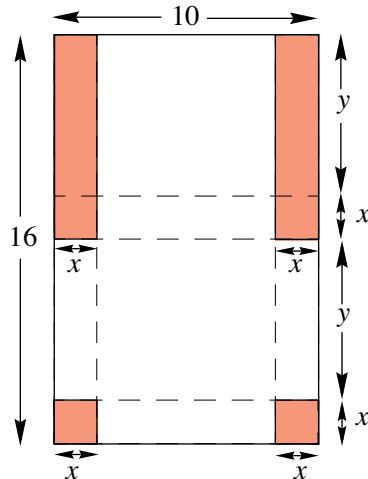

The cardboard is then folded along the dotted lines to form a rectangular box with a lid.

- (a) Express y in terms of x , and hence show that the volume, $V \text{ cm}^3$, of the box is given by
- $$V = 2x^3 - 26x^2 + 80x.$$
- (b) i. Find the value of x such that the volume of the box is a maximum. Justify that you have obtained a maximum by considering the sign of $V'(x)$.
- ii. Find the maximum volume of the box.

13. Find $f'(x)$ if i. $f(x) = \sqrt{1-3x^2}$ ii. $f(x) = \frac{e^x}{1+e^x}$

- 14.** The graph of the function $y = f(x)$ is shown alongside.
Sketch the graph of $y = f'(x)$.

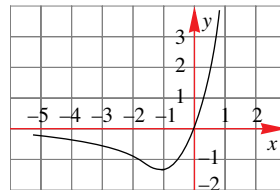

- 15.** A closed cylindrical tin can is being designed. Its volume is to be 1000 cm^3 . Its curved surface is to be shaped from a rectangular piece of tin sheet. Each of its circular ends (of radius r cm) is to be cut from a square of tin sheet, as shown, with the shaded sections being wasted.

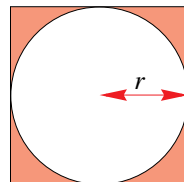

- (a) If h cm is the height of the can, express h in terms of r .
Hence show that the area, $A \text{ cm}^2$, of tin sheet needed for a can is given by
- $$A = \frac{2000}{r} + 8r^2$$
- (b) Find the radius and height of the can for which the area of tin sheet needed is a minimum.
Justify that you have obtained a minimum by considering the sign of the first derivative.

- 16.** Given that $f(x) = x^3$
- (a) Find $f(x+h) - f(x)$.
- (b) Simplify $\frac{f(x+h) - f(x)}{h}$, $h \neq 0$.
- (c) Find $\lim_{h \rightarrow 0} \frac{f(x+h) - f(x)}{h}$ and hence state $f'(x)$.

- 17.** In a certain country which has a controlling birth rate and an ageing population, the predicted population P million, t years after 1980, is given by

$$P = 27.5 + 0.8te^{-0.02t}, t \geq 0.$$

- (a) Find $\frac{dP}{dt}$.
- (b) What is the predicted population for the year 2080?
- (c) i. In the year 2080, will the population be increasing or decreasing?
ii. At what rate, in millions per year, will it be changing?
- (d) In what year is it predicted that the population will reach a maximum, and what will this maximum population be?

- 18.** A piece of airline baggage is in the shape of a cuboid of width x centimetres, length $3x$ centimetres and depth h centimetres.

If the sum of its width and its length and its depth is 140 centimetres (the maximum allowed by the airline), find its greatest possible volume.

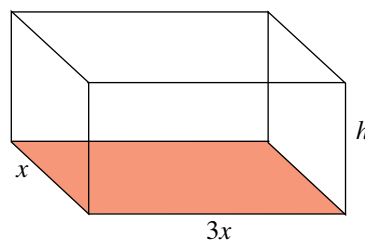

MATHEMATICS – Higher Level (Core)

19. Find $f'(x)$ if i. $f(x) = \frac{x}{1 + \cos x}$ ii. $f(x) = \log_e \sqrt{x^2 + 1}$

- 20.** Let P and Q be the points on the curve $y = x^3$ at which $x = 2$ and $x = 2 + h$, respectively.
- (a) Express the gradient of the line [PQ] in terms of h .
- (b) Hence find the gradient of the tangent to the curve $y = x^3$ at $x = 2$.

- 21.** In a competition, a surf lifesaver has to race from a starting point S on the beach, at the edge of the water, to a buoy B which is 200 metres along the water's edge from S. He can run along the beach at an average speed of 4 metres per second and he can swim through the water at an average speed of 1 metre per second. Assume that he starts swimming as soon as he enters the water.
- (a) How long will the lifesaver take
- i. to swim in a straight line from S to B?
- ii. to run along the beach to A and then swim straight out to B?
- (b) Show that, if the lifesaver runs x metres along the beach to C and then swims in a straight line to B, the time taken will be T seconds, where

$$T = \frac{x}{4} + \sqrt{80000 - 400x + x^2}$$

- (c) Hence find, to the nearest second, the shortest possible time for the lifesaver to go from S to B.

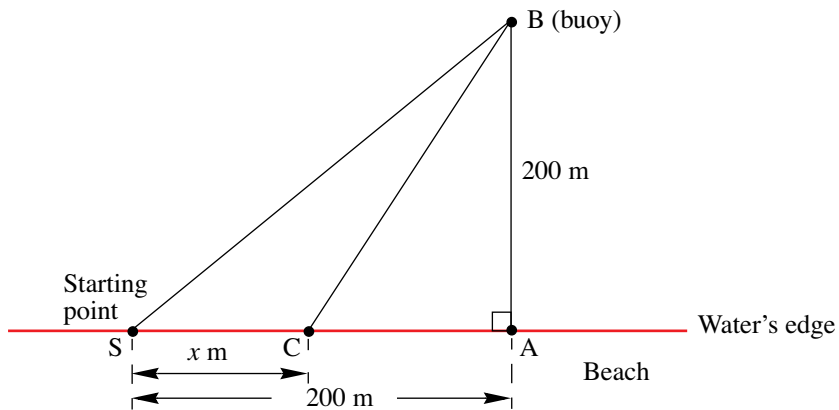

- 22.** The graph of $y = ax^3 + bx^2 + cx$ passes through the point $(-1, 16)$ and has a stationary point at $(1, -4)$. Find the values of a , b and c .

- 23.** (a) Find $f'\left(\frac{\pi}{6}\right)$ if $f(x) = \log_e(\tan x)$.
- (b) Find the derivative of i. $\cos^2 3x$. ii. $\sin^{-1} \sqrt{x}$.

- 24.** For the curve with equation $x^3 + xy^2 + 2y^3 = 0$, find the equation of the normal through the point $(1, -1)$.

- 25.** Find the maximum and minimum values of $y = (x - 1)(x - 4)^3$, for $0 \leq x \leq 5$.

- 26.** Differentiate i. $\sqrt{2 - 3 \sin x}$ ii. $e^{2x} \cos \frac{1}{2}x$ iii. $\frac{\ln x}{x}, x > 0$

- 27.** A capsule is to be constructed by closing the ends of a circular cylinder, of height h and radius r , with hemispherical caps of radius r .

- (a) Express the volume, V , of the capsule in terms of r and h .
 (b) If the cylindrical part of the capsule can be made at a cost of k dollars per unit area of surface and the spherical parts at a cost of $\frac{3}{2}k$ dollars per unit area of surface, and the total cost of making the capsule is P dollars, express P in terms of k , r and h .

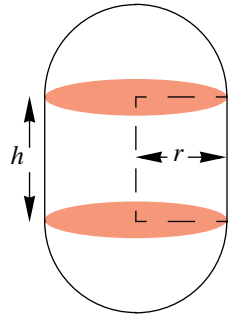

[The surface area of a sphere of radius r is $4\pi r^2$]

- (c) If V is constant, express P as a function of r .
 (d) What is the domain of this function?
 (e) Find the value of r for which P is a minimum, and hence show that the least expensive capsule is one whose total length is twice its diameter.
- 28.** ABCD is a square sheet of cardboard, with side a units. Creases [WZ] and [XY] are made parallel to [AD] as shown in diagram (i), to form flaps of width x units. These flaps are folded up to form a triangular prism with open ends. (see diagram (ii)).

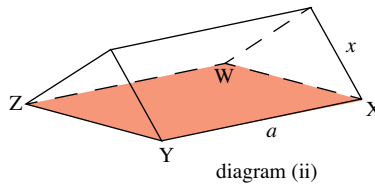
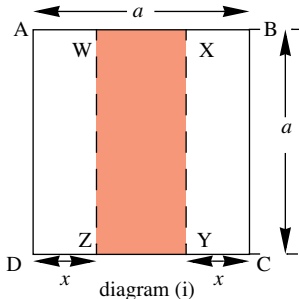

- (a) Show that the volume, V cubic units, of the prism is given by

$$V = \frac{a}{4}(a - 2x)\sqrt{4ax - a^2}.$$

- (b) State the domain of this function.
 (c) Find the maximum volume of the prism. Justify your answer.
- 29.** A saucepan (without a lid) is in the shape of a cylinder with handle attached. The cylindrical part has an internal base radius r cm an internal height h cm and is to be lined with a non-stick coating whose cost is proportional to the internal surface area.

If the saucepan must be able to hold a fixed volume, V cm³, show that the cost of lining it is a minimum when its height is equal to its base radius.

- 30.** Differentiate with respect to x :
- $\cos^3 2x$
 - $x\sqrt{1-x^2}$

- 31.** Find the equation of the tangent to the curve $x^2 + 2xy + 2y^2 = 8$ at the point $(0, 2)$.

- 32.** The volume of a cube is increasing at a rate of 54 cm³ s⁻¹. Find the rate of increase of the length of an edge of the cube when the volume of the cube is 216 cm³.

MATHEMATICS – Higher Level (Core)

- 33.** When a bus travels along a straight road from one stop to the next, its velocity-time function for the trip is described by $v(t) = \frac{1}{10}t(5 - t)$.

- State the domain of this function.
- Sketch the graph of the function.
- Find the maximum value of v .
- Find a rule for the acceleration of the bus between the stops.
- Sketch the acceleration-time graph for this bus.

- 34.** A closed capsule is to be constructed as shown in the diagram. It consists of a cylinder of height h which has a flat base of radius r and is surmounted by a hemispherical cap.

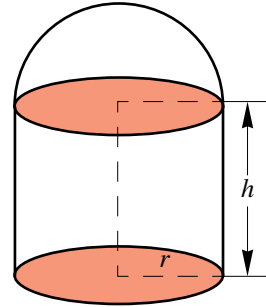

- Show that the volume, V , and the total surface area, A , are given by
 - $V = \pi r^2 h + \frac{2}{3}\pi r^3$.
 - $A = 2\pi r h + 3\pi r^2$.
- If $V = \pi a^3$, where a is a positive constant, show that $A = \frac{2\pi}{r}a^3 + \frac{5\pi}{3}r^3$.
- Hence find in terms of a the minimum and maximum surface area of the capsule, if its overall height (including the cap) must not be more than twice its diameter.

- 35.** Find the derivatives with respect to x of each of the following:

- $e^{-x} \cos x$
- $\sqrt[3]{x^3 + 3x^2 + 3x + 1}$

- 36.** A filter paper is in the form of an inverted cone, with base radius 6 centimetres and height 9 centimetres. Water is flowing out at the bottom at a constant rate of 40 cm^3 per minute.

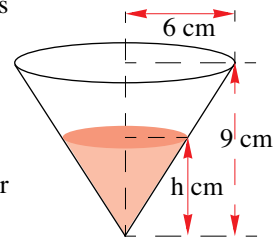

- If $V \text{ cm}^3$ is the volume of liquid in the cone when the depth of the liquid is h centimetres, find an expression for V in terms of h .
- Find, correct to the nearest second, the time which it takes for the level of the liquid in the cone to fall from 6 centimetres above the vertex of the cone to 5 centimetres above the vertex.
- Find the rate at which the level of the liquid in the cone is falling when the depth of the liquid is 5 centimetres, giving your answer correct to two decimal places.

- 37.** For what values of x will the function $f(x) = 2x + \frac{1}{2x}$, $x \neq 0$
- be increasing?
 - be decreasing?

- 38.** A curve has equation $2xy^3 + 4x^2 - y^2 = 1$. Find the gradient of the normal to the curve at the point $(-1, 1)$.

- 39.** (a) Use the definition $\tan \theta = \frac{\sin \theta}{\cos \theta}$ and the quotient rule to show $\frac{d}{d\theta}(\tan \theta) = \sec^2 \theta$.
- (b) A rectangular prison is surrounded by a high stone wall 400 m long and 250 m wide. At night, this wall is kept under constant surveillance by a search light placed on a tower at O , the exact centre of the prison. This light has a narrow beam, which rotates at the constant rate of 0.1 radian per second.

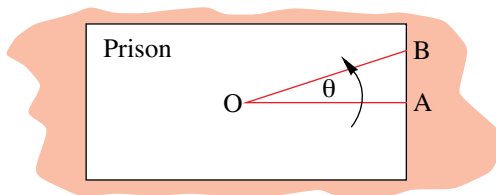

- If B is the position of a variable point along one of the shorter (250m) walls find an expression (in terms of θ) for the distance AB (where A is the centre of the same wall).
 - Find also an expression (in m/s) for the rate at which the beam is moving along the wall when it passes B .
 - At which point is the beam moving along the wall at the slowest speed?
 - In an attempt to escape, one of the prisoners has managed to position himself at A . He knows that it will take him a full minute to scale the wall. Will he be able to successfully complete his escape in the time available between successive rotations of the beam?
- 40.** Differentiate (a) $x \sin^{-1}(x)$ (b) $\frac{\ln(x^2 + 1)}{x}$
- 41.** For the graph of $y = \frac{(3-x)^2}{2-x}$
- find the coordinates of the points where it meets the coordinate axes.
 - find the equation of all asymptotes.
 - find the coordinates of any turning points.
 - sketch the graph.
- 42.** (a) If $y = \ln(2x^2 + 3)$, find $\frac{d^2y}{dx^2}$. (b) Find $f'\left(\frac{\pi}{6}\right)$ if $f(x) = \sec^2 x$.
- 43.** (a) The equations of the tangents to the hyperbola $y^2 - x^2 = 4$ pass through the point $(0, 1)$. Find the equations of these tangents.
- (b) Find the coordinates of the points of contact of these tangents with the hyperbola.
- 44.** (a) i. Sketch the graph of $f: [-2, 2] \rightarrow \mathbb{R}$, where $f(x) = -\sqrt{4-x^2}$.
- ii. State why f^{-1} does not exist.
- (b) Given that $f_1: [c, 0] \rightarrow \mathbb{R}$, where $f_1(x) = f(x)$ is its own inverse function, find c .
- (c) Let $g: \mathbb{R} \rightarrow \mathbb{R}$, where $g(x) = 2 \cos x$.
- Given that $f \circ g$ exists, find $f \circ g$, giving its domain, range and rule.
 - State the domain of $(f \circ g)'$.

MATHEMATICS – Higher Level (Core)

- 45.** Noriko, whose eyes are 1.5 m above the ground walks towards a lamp-post which is 6.5 m high at a speed of 4 ms^{-1} . Find the rate at which the angle of elevation of the top of the lamp-post to the horizontal level of her eyes changes with time when she is a horizontal distance of 10 m from the lamp-post.
- 46.** Find the equation of the tangent to the curve $y = e^{x-2}$ at the point where $x = 1$.
- 47.** For the graph with equation $y = \frac{2x}{1-x^2}$
- find the equations of all asymptotes,
 - show that the gradient is always positive,
 - sketch the graph, showing clearly how it approaches its asymptotes.
- 48.** Find $\frac{d^2y}{dx^2}$ for (a) $y = e^{-x}\cos 2x$ (b) $\frac{\cos^{-1}x}{x}$
- 49.** Find the equation of the tangent at the specified point for each of the following
- $y = 3^x, (1, 3)$
 - $y = \log_2(x+2), (-1, 0)$
- 50.** Find the domain and range of $f'(x)$ where $f(x) = |x+4| + |x|$.
- 51.** Two straight roads [OA] and [OB] intersect at 60° at O. A man walks towards O along [AO] at the rate of 10 km hr^{-1} . Given that $OB = 8 \text{ km}$, find the rate at which the man is approaching a house at B at the instant when he is 6 km from O.
- 52.** A right circular cone is such that its height is equal to the radius of its base. The axis of the cone is vertical and its vertex is downwards. A liquid is poured steadily into the cone at a rate of $0.01 \text{ m}^3\text{s}^{-1}$. Find the rate at which the level of liquid in the cone is rising when the liquid level reaches a height of 0.5 m.
- 53.** A box is attached to a taut rope 15 metres long passing over a fixed pulley 5 metres above the ground level. The other end of the rope is attached to a point on a scooter 1 metre above the ground level. The scooter heads off at a rate of 3 ms^{-1} away from the pulley. How fast is the box rising when it is 2 metres above ground level.
- 54.** Cars A and B are stationary on a straight road, standing side by side. Car A moves off with an acceleration of 1 ms^{-2} , which is maintained for twenty seconds, after which it continues to move with constant speed. Twenty seconds after A starts, B sets off in pursuit of A with constant acceleration 2 ms^{-2} , until it draws level with A. Find
- the time taken by B in pursuit, correct to the nearest second.
 - the distance travelled by B in pursuit, correct to the nearest metre.
- 55.** A book is being prepared for publication. Each page has height y cm, width x cm and a fixed total area of 294 cm^2 . Each page has 3 cm margin at both top and bottom and a 2 cm margin on each side. Let A be the area of that part of the page which is available for printing.
- Express A in terms of x . What restrictions are there on the values of x .
 - Find the dimensions of a page which will provide maximum space for printing.

56. The graph of $y = \frac{x^2 - 3x - 4}{x - 3}$ is shown alongside.

- Find the values of a , b and c .
- Show that $k = 1$ and $m = 3$.
- Using the first derivative of y , show that the graph is always increasing.

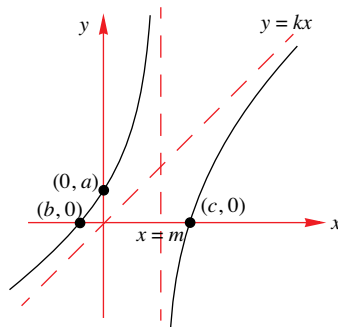

57. A piece of wire of length L units can be used in any of the following ways:

- the total length can be bent to form an equilateral triangle;
- the total length can be bent to form a circle;
- the wire can be cut so that part of the wire is bent to form an equilateral triangle and the remainder is bent to form a circle.

Let $3x$ represent the length of wire used to form an equilateral triangle irrespective of which of the three ways is chosen.

- State the possible values which x can take.
 - Show that the total area, A sq. units, of the total region or regions enclosed by the wire is given by

$$A(x) = \frac{x^2\sqrt{3}}{4} + \frac{(L-3x)^2}{4\pi}$$

- For what value of x does the graph of $y = A(x)$ have a stationary point?
 - Determine the nature of this stationary point.
 - Sketch the graph of $y = A(x)$.
- Find the value of x for which the total area enclosed by the wire is
 - a minimum.
 - a maximum.

58. (a) Find $\frac{d^2y}{dx^2}$ i. if $y = \tan^{-1}\left(\frac{1}{x}\right)$ ii. if $y = \frac{x-3}{3x+2}$

(b) Find the equation of the normal to the curve $y = 4 \times 5^x$ at the point $(1, 20)$.

(c) Find gradient of the curve $y = 2\log_4(x-2)$ where it crosses the x -axis.

(d) The position of an object from O is x m at time t seconds where $x = \frac{2^{2t} + 1}{2^t}$, $t > 0$.

Find the object's velocity after 1 second.

59. For the local fisherman the height of the water in the Port Campbell estuary has been known to follow the rule $H(t) = a + 3\cos(bt)$, where H m, is the height of the water and t hours the time after midnight. On the 9th August 2004 the height of the water at midnight was 11 metres and the height at 5:30 am was 5 metres.

- Using the above information find the values of a and b .
- Sketch the graph of H for an 11 hour period starting midnight on the 9th Aug 2004.

MATHEMATICS – Higher Level (Core)

For this particular estuary the speed of the current in and out of the estuary is directly proportional to the rate of change of height of the water.

- (c) Find an expression for the rate of change of height and explain why some of the values can be negative.
- (d) At 2:45 am it is known that the speed of the current out of the estuary reaches its maximum speed of 8 m/s. Find an expression for the speed of the current at time t .

- 60.** In response to the number of boating accidents during the last summer the local government is testing a new ‘Stay-bright’ flare.

Light from a flare at A shines on a small plate at B which is horizontal. It is observed that the intensity, I , of the light is directly proportional to $\frac{\cos \theta}{d^2}$, where d is the distance from A to B, and θ is the angle of incidence as shown in the diagram below.

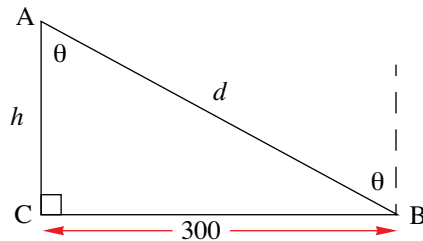

At time t seconds the flare is h metres above point C on the horizontal and C is 300 metres from B.

- (a) Show that $I = k \cos \theta \sin^2 \theta$ for some constant k .
- (b) If $I = 72$ when $h = 400$, evaluate k .
- (c) Find an expression for $\frac{dI}{d\theta}$.
- (d) Find, to the nearest metre, the height h at which I is greatest.
- (e) What is the maximum value of I ?

The flare is falling vertically at a constant rate of 5 metres per second.

- (f) i. Show that $\frac{d\theta}{dt} = \frac{1}{60} \sin^2 \theta$
- ii. Find $\frac{dI}{dt}$ when $\theta = \frac{\pi}{3}$

- 61.** A search light is located at ground level vertically below the path of an approaching aircraft, which is flying at a constant speed of 400 ms^{-1} , at a height of 10,000 m. If the light is continuously directed at the aircraft, find the rate, in degrees per second, at which the searchlight is turning at the instant when the aircraft is at a horizontal distance of 5000 m from the searchlight. Give your answer to three **significant** figures.

22.1 INTEGRATION

22.1.1 ANTIDIFFERENTIATION & THE INDEFINITE INTEGRAL

As the name suggests— **Anti differentiation** is the reverse process of differentiation. We are then searching for the answer to the following:

Given an expression $f'(x)$ (i.e., the derivative of the function $f(x)$), what must the original function $f(x)$ have been?

For example, if $f'(x) = 2x$ then $f(x) = x^2$ is a *possible expression* for the original function. Why do we say ‘... is a possible expression for the original function.’?

Consider the following results:

- i. $f(x) = x^2 + 3 \Rightarrow f'(x) = 2x$
- ii. $f(x) = x^2 - 5 \Rightarrow f'(x) = 2x$

From i., and ii., we see that given an expression $f'(x)$, there are a number of possible different original functions, $f(x)$. This is due to the fact that the derivative of a constant is zero and so when we are given an expression for $f'(x)$, there is no real way of knowing if there was a constant in the original function or what that constant might have been (unless we are given some extra information).

The best that we can do at this stage is to write the following:

$$\text{Given that } f'(x) = 2x, \text{ then } f(x) = x^2 + c,$$

where c is some real number that is yet to be determined (it could very well be that $c = 0$).

The antidifferentiation process described above can be summarised as follows:

Given that $\frac{dy}{dx} = f'(x)$, then (after antidifferentiating) $y = f(x) + c$, where $c \in \mathbb{R}$.

We say that $y = f(x) + c$, where $c \in \mathbb{R}$ is the **antiderivative** of $f'(x)$.

22.1.2 LANGUAGE AND NOTATION

The set of all antiderivatives of a function $h(x)$ is called the **indefinite integral** of $h(x)$, and is denoted by $\int h(x)dx$.

The symbol \int is called the **integral sign**,
the function $h(x)$ is the **integrand** of the integral
and x is the **variable of integration**.

MATHEMATICS – Higher Level (Core)

Once we have found an antiderivative (or indefinite integral) of $h(x)$, $H(x)$ (say) we can then write

$$\int h(x)dx = H(x) + c, \text{ where } c \in \mathbb{R}.$$

The constant c is called the **constant of integration**. The above result is read as:

‘The **antiderivative** of $h(x)$ with respect to x is $H(x) + c$, where $c \in \mathbb{R}$ ’.
 or
 ‘The **indefinite integral** of $h(x)$ with respect to x is $H(x) + c$, where $c \in \mathbb{R}$ ’.

22.1.3 DETERMINING THE INDEFINITE INTEGRAL

So — how do we find the indefinite integral of $h(x)$?

We approach this problem by searching for a pattern (pretty much as we did when dealing with the derivative of a function). Recall the following results (when were searching for a rule to find the derivative of a function):

$h(x)$	x	x^2	x^3	x^4	x^5	\dots	x^n
$h'(x)$	1	$2x$	$3x^2$	$4x^3$	$5x^4$	\dots	nx^{n-1}

The differentiation process was then described using the following ‘progress’ diagram:

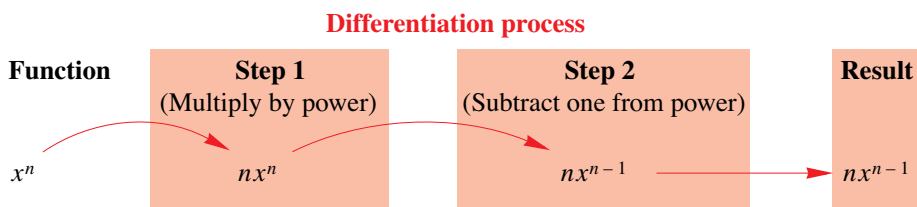

Finding the indefinite integral requires that we ‘*reverse the process*’ (i.e., carry out the inverse operation). Again this can be illustrated using a ‘progress’ diagram:

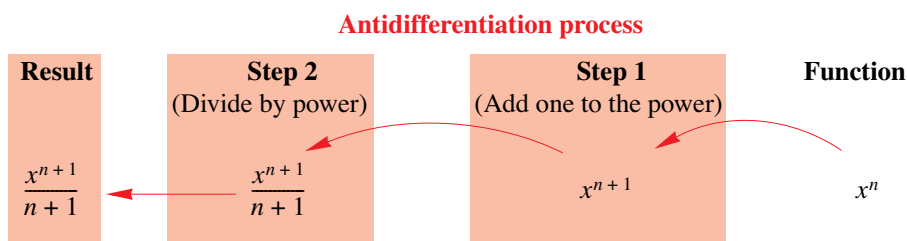

However, as we discussed previously, we must add a real constant to complete the process of antidifferentiation. We then have the general result:

$$\int x^n dx = \frac{x^{n+1}}{n+1} + c \text{ or } \frac{1}{n+1}x^{n+1} + c \text{ as long as } n \neq -1.$$

A slightly more general result is one where we have ax^n rather than simply x^n . In this case we have that

$$\int ax^n dx = \frac{ax^{n+1}}{n+1} + c \quad \text{or} \quad \frac{a}{n+1}x^{n+1} + c \quad \text{as long as } n \neq -1.$$

EXAMPLE 22.1

Find the indefinite integral of the following

- (a) $4x^2$ (b) x^{-3} (c) $5\sqrt{x}$ (d) $\sqrt[5]{x^3}$

S
o
l
u
t
i
o
n

In each case we use the ‘progress’ diagram on the previous page. That is, we first increase the power by one and then divide by the new power.

$$(a) \quad \int 4x^2 dx = \frac{4}{2+1}x^{2+1} + c, c \in \mathbb{R} = \frac{4}{3}x^3 + c, c \in \mathbb{R}$$

$$(b) \quad \int x^{-3} dx = \frac{1}{-3+1}x^{-3+1} + c, c \in \mathbb{R} = -\frac{1}{2}x^{-2} + c, c \in \mathbb{R} \\ = -\frac{1}{2x^2} + c, c \in \mathbb{R}$$

$$(c) \quad \int 5\sqrt{x} dx = \int 5x^{\frac{1}{2}} dx = \frac{5}{\frac{1}{2}+1}x^{\frac{1}{2}+1} + c, c \in \mathbb{R} \\ = \frac{5}{(3/2)}x^{3/2} + c, c \in \mathbb{R} \\ = \frac{10}{3}\sqrt{x^3} + c, c \in \mathbb{R}$$

Notice that before we can start the antidifferentiation process we must express the integrand in the form ax^n , i.e., in power form.

$$(d) \quad \int \sqrt[5]{x^3} dx = \int x^{\frac{3}{5}} dx = \frac{1}{\frac{3}{5}+1}x^{\frac{3}{5}+1} + c, c \in \mathbb{R} \\ = \frac{1}{(8/5)}x^{\frac{8}{5}} + c, c \in \mathbb{R} \\ = \frac{5}{8}\sqrt[5]{x^8} + c, c \in \mathbb{R}$$

Although we have been working through examples that are made up of only one integrand, we can determine the indefinite integral of expressions that are made up of several terms.

EXAMPLE 22.2

Find the integral of

- (a) $\int (2x^2 + x^3 - 4) dx$ (b) $\int (x-1)(x^4 + 3x) dx$ (c) $\int \frac{z^4 - 2z^2 + 3}{z^2} dz$

$$\begin{aligned} \text{(a)} \quad \int(2x^2 + x^3 - 4)dx &= \int 2x^2 dx + \int x^3 dx - \int 4 dx = \frac{2}{2+1}x^{2+1} + \frac{1}{3+1}x^{3+1} - 4x + c \\ &= \frac{2}{3}x^3 + \frac{1}{4}x^4 - 4x + c, c \in \mathbb{R} \end{aligned}$$

When determining the indefinite integral of 4, we have actually thought of ‘4’ as ‘ $4x^0$ ’. So that

$$\int 4 dx = \int 4x^0 dx = \frac{4}{0+1}x^{0+1} = 4x.$$

$$\text{(b)} \quad \int(x-1)(x^4+3x)dx = \int(x^5-x^4+3x^2-3x)dx = \frac{1}{6}x^6 - \frac{1}{5}x^5 + x^3 - \frac{3}{2}x^2 + c, c \in \mathbb{R}.$$

$$\begin{aligned} \text{(c)} \quad \int \frac{z^4 - 2z^2 + 3}{z^2} dz &= \int \left(\frac{z^4}{z^2} - \frac{2z^2}{z^2} + \frac{3}{z^2} \right) dz = \int (z^2 - 2 + 3z^{-2}) dz \\ &= \frac{1}{3}z^3 - 2z + \frac{3}{-1}z^{-1} + c \\ &= \frac{1}{3}z^3 - 2z - \frac{3}{z} + c, c \in \mathbb{R} \end{aligned}$$

Notice that in part (b) it was necessary to first multiply out the brackets **before** we could integrate. Similarly, for part (c) we had to first carry out the division **before** integrating.

22.1.4 PROPERTIES OF THE INDEFINITE INTEGRAL

In many of the above examples we made use of the following properties

Properties	Examples
1. $\int h'(x)dx = h(x) + c$	$\int \frac{d}{dx}(x^2)dx = \int (2x)dx = x^2 + c$
2. $\frac{d}{dx}(\int h(x)dx) = h(x)$	$\frac{d}{dx}(\int (x^3)dx) = \frac{d}{dx}\left(\frac{1}{4}x^4 + c\right) = x^3$
3. $\int kh(x)dx = k\int h(x)dx$	$\begin{aligned} \int 12x^3 dx &= 12\int x^3 dx = 12 \times \left(\frac{1}{4}x^4 + c\right) \\ &= 3x^4 + C \end{aligned}$
4. $\int (h(x) \pm f(x))dx = \int h(x)dx \pm \int f(x)dx$	$\begin{aligned} \int (2x - 3x^2)dx &= \int 2x dx - \int 3x^2 dx \\ &= x^2 - x^3 + c \end{aligned}$

EXERCISES 22.1

1. Find the indefinite integral of the following:

- | | | | |
|------------|------------|------------|----------------------|
| (a) x^3 | (b) x^7 | (c) x^5 | (d) x^8 |
| (e) $4x^2$ | (f) $7x^5$ | (g) $9x^8$ | (h) $\frac{1}{2}x^3$ |

2. Find:

(a) $\int 5dx$ (b) $\int 3dx$ (c) $\int 10dx$ (d) $\int \frac{2}{3}dx$

(e) $\int -4dx$ (f) $\int -6dx$ (g) $\int -\frac{3}{2}dx$ (h) $\int -dx$

3. Find:

(a) $\int (1-x)dx$ (b) $\int (2+x^2)dx$ (c) $\int (x^3-9)dx$

(d) $\int \left(\frac{2}{5} + \frac{1}{3}x^2\right)dx$ (e) $\int \left(\frac{2}{4}\sqrt{x} - \frac{1}{x^2}\right)dx$ (f) $\int \left(\frac{5}{2}\sqrt{x^3} + 8x\right)dx$

(g) $\int x(x+2)dx$ (h) $\int x^2\left(3 - \frac{2}{x}\right)dx$ (i) $\int (x+1)(1-x)dx$

4. Find the antiderivative of the following:

(a) $(x+2)(x-3)$ (b) $(x^2-3x)(x+1)$ (c) $(x-3)^3$

(d) $(x+2x^3)(x+1)$ (e) $(1-\sqrt{x})(1+x)$ (f) $\sqrt{x}(x+1)^2-2$

5. Find:

(a) $\int \frac{x^2-3x}{x}dx$ (b) $\int \frac{4u^3+5u^2-1}{u^2}du$ (c) $\int \frac{(x+2)^2}{x^4}dx$

(d) $\int \frac{x^2+5x+6}{x+2}dx$ (e) $\int \frac{x^2-6x+8}{x-2}dx$ (f) $\int \left(\frac{t^2+1}{t}\right)^2 dt$

6. Find the indefinite integral of the following:

(a) $\sqrt[4]{x^3} + \frac{1}{\sqrt{x}} - 5$ (b) $\sqrt{x}(\sqrt{x}-2x)(x+1)$ (c) $\frac{1}{z^3} - \frac{2}{z^2} + 4z + 1$

(d) $\left(2t + \frac{3}{t^2}\right)\left(t^2 - \frac{1}{t}\right) + \frac{3}{t^3}$ (e) $\frac{(t-2)(t-1)}{\sqrt{t}} - \frac{2}{\sqrt{t}}$ (f) $\frac{u^3+6u^2+12u+8}{u+2}$

7. Given that $f(x) = ax^n$, $n \neq -1$ and $g(x) = bx^m$, $m \neq -1$ show that

(a) $\int [f(x) + g(x)]dx = \int f(x)dx + \int g(x)dx$

(b) $\int [f(x) - g(x)]dx = \int f(x)dx - \int g(x)dx$

(c) $\int kf(x)dx = k\int f(x)dx$

(d) $\int f(x)g(x)dx \neq (\int f(x)dx)(\int g(x)dx)$, $n+m \neq -1$.

(e) $\int \frac{f(x)}{g(x)}dx \neq \frac{\int f(x)dx}{\int g(x)dx}$, $n-m \neq -1$

8. (a) Show that $\frac{d}{dx}((2x+3)^4) = 8(2x+3)^3$. Hence find $\int (2x+3)^3 dx$.

(b) Show that $\frac{d}{dx}(\sqrt{x^2+4}) = \frac{x}{\sqrt{x^2+4}}$. Hence find $\int \frac{3x}{\sqrt{x^2+4}} dx$.

22.2 SOLVING FOR “C”

Although we have already discussed the reason for ‘adding’ a constant, c , when finding the indefinite integral, it is important that we can also determine the value of c .

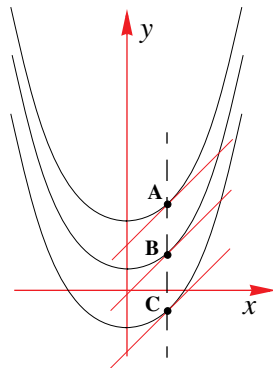

Given that $\frac{dy}{dx} = 2x$, upon antidifferentiating, we have $y = x^2 + c$.

This result is known as the **general solution**.

Some of the possible curves, $y = x^2 + c$, are shown, and we observe that at A, B and C, for a particular value of x , the gradients are equal.

To determine which of these curves is the one that we actually require, we must be provided with some extra information. In this case we would need to be given the coordinates of a point on the curve.

EXAMPLE 22.3

Find $f(x)$ given that $f'(x) = 2x$ and that the curve passes through the point $(2,9)$.

Solution

As $f'(x) = 2x \Rightarrow f(x) = x^2 + c$.

Using the fact that at $x = 2, y = 9$, or that $f(2) = 9$, we have $9 = 2^2 + c \Leftrightarrow c = 5$.

Therefore, of all possible solutions of the form $y = x^2 + c$, the function satisfying the given information is $f(x) = x^2 + 5$.

EXAMPLE 22.4

Find $f(x)$ given that $f''(x) = 6x - 2$ and that the gradient at the point $(1,5)$ is 2.

Solution

From the given information we have that $f'(1) = 2$ and $f(1) = 5$.

As $f''(x) = 6x - 2$ we have $f'(x) = 3x^2 - 2x + c_1$ — (1).

But, $f'(1) = 2 \therefore 2 = 3(1)^2 - 2(1) + c_1 \Leftrightarrow c_1 = 1$. [i.e., substituting into (1)]

Therefore, we have $f'(x) = 3x^2 - 2x + 1$.

Next, from $f'(x) = 3x^2 - 2x + 1$ we have $f(x) = x^3 - x^2 + x + c_2$ — (2).

But, $f(1) = 5 \therefore 5 = (1)^3 - (1)^2 + (1) + c_2 \Leftrightarrow c_2 = 4$. [i.e., substituting into (2)]

Therefore, $f(x) = x^3 - x^2 + x + 4$

Sometimes, information is not given in the form of a set of coordinates. Information can also be ‘hidden’ in the context of the problem.

EXAMPLE 22.5

The rate of change in pressure, p units, at a depth x cm from the surface of a liquid is given by $p'(x) = 0.03x^2$. If the pressure at the surface is 10 units, find the pressure at a depth of 5 cm.

**S
o
l
u
t
i
o
n**

Antidifferentiating both sides with respect to x , we have $\int p'(x)dx = \int 0.03x^2 dx$.

$$\therefore p(x) = 0.01x^3 + c \quad (1)$$

At $x = 0$, $p = 10$. Substituting into (1) we have $10 = 0.01(0)^3 + c \Leftrightarrow c = 10$

Therefore, the equation for the pressure at a depth of x cm is $p(x) = 0.01x^3 + 10$.

At $x = 5$, we have $p(5) = 0.01(5)^3 + 10 = 11.25$. That is, the pressure is 11.25 units.

EXAMPLE 22.6

The growth rate of a city's population has been modelled by the equation $\frac{dN}{dt} = 400t^{1.05}$, $t \geq 0$ where t is the time in years after 1995 and N is the population size. In the year 2000 the population numbered 32,000. What will the population be in 2010?

**S
o
l
u
t
i
o
n**

We start by determining N :

$$\frac{dN}{dt} = 400t^{1.05} \Rightarrow \int \frac{dN}{dt} dt = \int 400t^{1.05} dt \quad [\text{i.e., antidiff. b.s. w.r.t. } t]$$

$$\therefore N = \frac{400}{2.05} t^{2.05} + c$$

$$= \frac{8000}{41} t^{2.05} + c$$

We are given that when $t = 5$, $N = 32000$.

$$\therefore 32000 = \frac{8000}{41}(5)^{2.05} + c \Leftrightarrow c = 26713.18$$

Therefore, we have that $N = \frac{8000}{41} t^{2.05} + 26713.18$.

Then, when $t = 15$, $N = \frac{8000}{41}(15)^{2.05} + 26713.18 = 76981.36$.

So, in 2010 the population would be 7,6981.

EXERCISES 22.2

- Find the equation of the function in each of the following:
 - $f'(x) = 2x + 1$, given that the curve passes through (1,5).
 - $f'(x) = 2 - x^2$ and $f(2) = \frac{7}{3}$.

MATHEMATICS – Higher Level (Core)

(c) $\frac{dy}{dx} = 4\sqrt{x} - x$, given that the curve passes through (4,0).

(d) $f'(x) = x - \frac{1}{x^2} + 2$, and $f(1) = 2$

(e) $\frac{dy}{dx} = 3(x+2)^2$, given that the curve passes through (0,8).

(f) $\frac{dy}{dx} = \sqrt[3]{x} + x^3 + 1$, given that the curve passes through (1,2).

(g) $f'(x) = (x+1)(x-1) + 1$, and $f(0) = 1$

(h) $f'(x) = 4x^3 - 3x^2 + 2$, and $f(-1) = 3$

- 2.** Find the equation of the function $f(x)$ given that it passes through the point $(-1,2)$ and is such that $f'(x) = ax + \frac{b}{x^2}$, where $f(1) = 4$ and $f'(1) = 0$.
- 3.** The marginal cost for producing x units of a product is modelled by the equation $C'(x) = 30 - 0.06x$. The cost per unit is \$40. How much will it cost to produce 150 units?
- 4.** If $\frac{dA}{dr} = 6 - \frac{1}{r^2}$, and $A = 4$ when $r = 1$, find A when $r = 2$.
- 5.** The rate, in cm^3/sec , at which the volume of a sphere is increasing is given by the relation $\frac{dV}{dt} = 4\pi(2t+1)^2$, $0 \leq t \leq 10$. If initially the volume is $\pi \text{ cm}^3$, find the volume of the sphere when $t = 2$.
- 6.** The rate of change of the number of deer, N , in a controlled experiment, is modelled by the equation $\frac{dN}{dt} = 3\sqrt{t^3} + 2t$, $0 \leq t \leq 5$. There are initially 200 deer in the experiment. How many deer will there be at the end of the experiment.
- 7.** If $\frac{dy}{dx} \propto \sqrt{x}$, find an expression for y , given that $y = 4$ when $x = 1$ and $y = 9$ when $x = 4$.
- 8.** A function with gradient defined by $\frac{dy}{dx} = 4x - m$ at any point P on its curve passes through the point $(2,-6)$ with a gradient of 4. Find the coordinates of its turning point.
- 9.** The marginal revenue is given by $\frac{dR}{dx} = 25 - 10x + x^2$, $x \geq 0$, where R is the total revenue and x is the number of units demanded. Find the equation for the price per unit, $P(x)$.
- 10.** The rate of growth of a culture of bacteria is modelled by the equation $200t^{1.01}$, $t \geq 0$, t hours after the culture begins to grow. Find the number of bacteria present in the culture at time t hours if initially there were 500 bacteria.

11. Sketch the graph of $y = f(x)$ for each of the following:

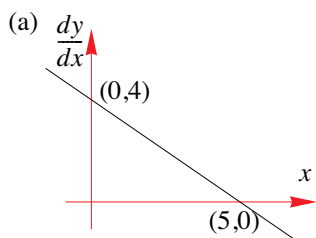

Where the curve passes through the point $(5, 10)$.

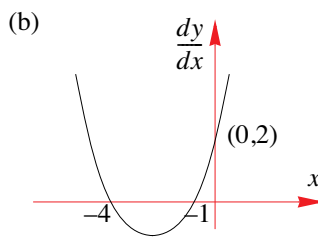

Where the curve passes through the point $(0, 0)$.

12. Find $f(x)$ given that $f''(x) = 12x + 4$ and that the gradient at the point $(1, 6)$ is 12.
13. Find $f(x)$ given that $f'(x) = ax^2 + b$, where the gradient at the point $(1, 2)$ is 4 and that the curve passes through the point $(3, 4)$.
14. The rate at which a balloon is expanding is given by $\frac{dV}{dt} = kt^{4.5}$, $t \geq 0$, where t is the time in minutes since the balloon started to be inflated and $V \text{ cm}^3$ is its volume. Initially the balloon (which may be assumed to be spherical) has a radius of 5 cm. If the balloon has a volume of 800 cm^3 after 2 minutes, find its volume after 5 minutes.
15. The area, $A \text{ cm}^2$, of a healing wound caused by a fall on a particular surface decreases at a rate given by the equation $A'(t) = -\frac{35}{\sqrt{t}}$ where t is the time in days. Find the initial area of such a wound if after one day the area measures 40 cm^2 .

22.3 STANDARD INTEGRALS

In the same way that there are rules for differentiating functions other than those of the form ax^n , we also have standard rules for integrating functions other than the ones that we have been dealing with so far. That is, there are standard rules for finding the indefinite integral of circular trigonometric functions, exponential functions and logarithmic functions.

We can deduce many such antiderivatives using the result $\int \frac{d}{dx}(h(x))dx = h(x) + c$ – (1).

For example, if we consider the derivative $\frac{d}{dx}(e^{2x}) = 2e^{2x}$,

We can write $\int \frac{d}{dx}(e^{2x})dx = \int 2e^{2x}dx$. But from (1) we have $\int \frac{d}{dx}(e^{2x})dx = e^{2x}$.

Therefore, $e^{2x} + c = \int 2e^{2x}dx$.

Or, we could write $e^{2x} + c = 2\int e^{2x}dx \Leftrightarrow \int e^{2x}dx = \frac{1}{2}(e^{2x} + c) = \frac{1}{2}e^{2x} + C$

MATHEMATICS – Higher Level (Core)

Similarly, $\frac{d}{dx}(\ln x) = \frac{1}{x}$ and so, antidifferentiating both sides we have $\int \frac{d}{dx}(\ln x) dx = \int \frac{1}{x} dx$.

Then, as $\int \frac{d}{dx}(\ln x) dx = \ln x$, we can write, $\ln x + c = \int \frac{1}{x} dx$.

We summarise these rules in the table below:

$f(x)$	$\int f(x) dx$	Examples
$ax^n, n \neq -1$	$\frac{a}{n+1} x^{n+1} + c, n \neq -1$	$\int 2x^2 dx = \frac{2}{3} x^3 + c$
$\frac{1}{x}, x \neq 0$	$\log_e x + c, x \neq 0$ or $\log_e x + c, x > 0$	$\int \frac{6}{x} dx = 6 \int \frac{1}{x} dx = 6 \log_e x + c, x > 0$
$\sin(kx)$	$-\frac{1}{k} \cos(kx) + c$	$\int \sin(5x) dx = -\frac{1}{5} \cos(5x) + c$
$\cos(kx)$	$\frac{1}{k} \sin(kx) + c$	$\int \cos\left(\frac{x}{4}\right) dx = \int \cos\left(\frac{1}{4}x\right) dx = \frac{1}{\left(\frac{1}{4}\right)} \sin\left(\frac{x}{4}\right) + c$ $= 4 \sin\left(\frac{x}{4}\right) + c$
$\sec^2(kx)$	$\frac{1}{k} \tan(kx) + c$	$\int \sec^2(2x) dx = \frac{1}{2} \tan(2x) + c$
e^{kx}	$\frac{1}{k} e^{kx} + c$	$\int e^{-3x} dx = -\frac{1}{3} e^{-3x} + c$

NB: In the above table (and from here on), the constant c is assumed to be a real number.

General power rule

The indefinite integral of $f(ax + b)$:

If $\int f(x) dx = F(x) + c$, then $\int f(ax + b) dx = \frac{1}{a} F(ax + b) + c$.

This means that all of the integrals in the table above can be generalised further.

In particular we consider the generalised power rule:

- $\int (ax + b)^n dx = \frac{1}{a(n+1)} (ax + b)^{n+1} + c, n \neq -1$
- $\int \frac{1}{ax + b} dx = \frac{1}{a} \log_e(ax + b) + c, ax + b > 0$

EXAMPLE 22.7

Find the antiderivative of

(a) $(3x + 7)^4$ (b) $3(4 - 2x)^5$ (c) $\sqrt{5x + 1}$ (d) $\frac{4}{(2x - 3)^2}$

Solution

 This question requires the use of the result: $\int (ax + b)^n dx = \frac{1}{a(n+1)}(ax + b)^{n+1} + c, n \neq -1$

(a)
$$\int (3x + 7)^4 dx = \frac{1}{3 \times (4 + 1)}(3x + 7)^{4+1} + c$$

$$= \frac{1}{15}(3x + 7)^5 + c$$

(b)
$$\int 3(4 - 2x)^5 dx = 3 \int (4 - 2x)^5 dx = 3 \times \frac{1}{(-2) \times (5 + 1)}(4 - 2x)^{5+1} + c$$

$$= \frac{3}{-2 \times 6}(4 - 2x)^6 + c$$

$$= -\frac{1}{4}(4 - 2x)^6 + c$$

(c)
$$\int \sqrt{5x + 1} dx = \int (5x + 1)^{1/2} dx$$
 [Note: we must first convert into power form!]

$$= \frac{1}{5 \times \left(\frac{1}{2} + 1\right)}(5x + 1)^{\frac{1}{2} + 1} + c$$

$$= \frac{2}{15}(5x + 1)^{\frac{3}{2}} + c$$

(d)
$$\int \frac{4}{(2x - 3)^2} dx = 4 \int (2x - 3)^{-2} dx$$

$$= 4 \times \frac{1}{2 \times (-2 + 1)}(2x - 3)^{-2+1} + c$$

$$= -2 \times (2x - 3)^{-1} + c$$

$$= -\frac{2}{(2x - 3)} + c$$

EXAMPLE 22.8

Find the antiderivative of

(a) $\sin 4x$ (b) $\cos\left(\frac{1}{2}x\right)$ (c) $\sec^2(3x)$

Solution

(a)
$$\int \sin 4x dx = -\frac{1}{4} \cos 4x + c.$$
 [Using $\int \sin(kx) dx = -\frac{1}{k} \cos(kx) + c$]

(b)
$$\int \cos\left(\frac{1}{2}x\right) dx = \frac{1}{\left(\frac{1}{2}\right)} \sin\left(\frac{1}{2}x\right) + c = 2 \sin\left(\frac{1}{2}x\right) + c.$$
 [Using $\int \cos(kx) dx = \frac{1}{k} \sin(kx) + c$]

(c) $\int \sec^2(3x)dx = \frac{1}{3}\tan(3x) + c$. [Using $\int \sec^2(kx)dx = \frac{1}{k}\tan(kx) + c$]

We can extend the results for the antiderivatives of circular trigonometric functions as follows:

$f(x)$	$\int f(x)dx$	Examples
$\sin(ax + b)$	$-\frac{1}{a}\cos(ax + b) + c$	$\int \sin(5x + 2)dx = -\frac{1}{5}\cos(5x + 2) + c$
$\cos(ax + b)$	$\frac{1}{a}\sin(ax + b) + c$	$\int \cos\left(\frac{x}{4} - 1\right)dx = \int \cos\left(\frac{1}{4}x - 1\right)dx$ $= 4\sin\left(\frac{x}{4} - 1\right) + c$
$\sec^2(ax + b)$	$\frac{1}{a}\tan(ax + b) + c$	$\int \sec^2(2x + 3)dx = \frac{1}{2}\tan(2x + 3) + c$

EXAMPLE 22.9

Find the antiderivative of

- (a) e^{2x} (b) $5e^{-3x}$ (c) $4x - 2e^{\frac{1}{3}x}$ (e) $\frac{5}{x}$ (f) $\frac{2}{3x+1}$

S
O
L
V
E
S
E
S
S
O
N

- (a) $\int e^{2x}dx = \frac{1}{2}e^{2x} + c$. [Using $\int e^{kx}dx = \frac{1}{k}e^{kx} + c$]
- (b) $\int 5e^{-3x}dx = 5\int e^{-3x}dx = 5 \times \frac{1}{-3}e^{-3x} + c = -\frac{5}{3}e^{-3x} + c$ [Using $\int e^{kx}dx = \frac{1}{k}e^{kx} + c$]
- (c) $\int (4x - 2e^{\frac{1}{3}x})dx = \int 4xdx - 2\int e^{\frac{1}{3}x}dx = 4 \times \frac{1}{2}x^2 - 2 \times \frac{1}{\left(\frac{1}{3}\right)}e^{\frac{1}{3}x} + c$ "
 $= 2x^2 - 6e^{\frac{1}{3}x} + c$
- (d) $\int \frac{5}{x}dx = 5\int \frac{1}{x}dx = 5\ln(x) + c, x > 0$
- (e) $\int \frac{2}{3x+1}dx = 2\int \frac{1}{3x+1}dx = \frac{2}{3}\ln(3x+1) + c, x > -\frac{1}{3}$ [$\int \frac{1}{ax+b}dx = \frac{1}{a}\log_e(ax+b) + c$]

As we have just done for the circular trigonometric functions, we can extend the antiderivative of the exponential function to

$$\int e^{ax+b}dx = \frac{1}{a}e^{ax+b} + c$$

EXAMPLE 22.10

Find

(a) $\int 2(4x-1)^6 dx$

(b) $\int \frac{7}{4-3x} dx$

(c) $\int \frac{3}{\sqrt{2x+1}} dx$

(d) $\int e^{-2x+3} dx$

(d) $\int (e^{-4x} + \sqrt[5]{3x+2}) dx$

(e) $\int \left(\cos\left(\frac{\pi}{2}x\right) - \frac{2}{6x+5} \right) dx$

S
o
l
u
t
i
o
n

(a) We have $n = 6$, $a = 4$ and $b = -1$, $\therefore \int 2(4x-1)^6 dx = \frac{2}{4(6+1)}(4x-1)^{6+1} + c$
 $= \frac{1}{14}(4x-1)^7 + c$

 (b) This time we use the case for $n = -1$, with $a = -3$ and $b = 4$, giving

$$\int \frac{7}{4-3x} dx = 7 \int \frac{1}{4-3x} dx = -\frac{7}{3} \log_e(4-3x) + c, x < \frac{4}{3}$$

(c) We first rewrite the indefinite integral in power form: $\int \frac{3}{\sqrt{2x+1}} dx = \int 3(2x+1)^{-\frac{1}{2}} dx$

 So that $a = 2$, $b = 1$ and $n = -\frac{1}{2}$. Therefore we have that

$$\begin{aligned} \int \frac{3}{\sqrt{2x+1}} dx &= \int 3(2x+1)^{-\frac{1}{2}} dx = \frac{3}{2\left(-\frac{1}{2}+1\right)}(2x+1)^{-\frac{1}{2}+1} + c \\ &= \frac{3}{2 \times \frac{1}{2}}(2x+1)^{\frac{1}{2}} + c \\ &= 3\sqrt{2x+1} + c \end{aligned}$$

(d) $\int e^{-2x+3} dx = -\frac{1}{2}e^{-2x+3} + c$

(e)
$$\begin{aligned} \int (e^{-4x} + \sqrt[5]{3x+2}) dx &= \int \left(e^{-4x} + (3x+2)^{\frac{1}{5}} \right) dx = -\frac{1}{4}e^{-4x} + \frac{1}{3\left(\frac{6}{5}\right)}(3x+2)^{\frac{6}{5}} + c \\ &= -\frac{1}{4}e^{-4x} + \frac{5}{18}\sqrt[5]{(3x+2)^6} + c \end{aligned}$$

(f)
$$\begin{aligned} \int \left(\cos\left(\frac{\pi}{2}x\right) - \frac{2}{6x+5} \right) dx &= \frac{1}{\frac{\pi}{2}} \sin\left(\frac{\pi}{2}x\right) - \frac{2}{6} \ln(6x+5) + c \\ &= \frac{2}{\pi} \sin\left(\frac{\pi}{2}x\right) - \frac{1}{3} \ln(6x+5) + c \end{aligned}$$

EXAMPLE 22.11

The gradient at any point on the curve $y = f(x)$ is given by the equation

$\frac{dy}{dx} = \frac{1}{\sqrt{x+2}}$. The curve passes through the point (2,3). Find the equation of this curve.

S
o
l
u
t
i
o
n

Integrating both sides of $\frac{dy}{dx} = \frac{1}{\sqrt{x+2}}$ with respect to x , we have $\int \frac{dy}{dx} dx = \int \frac{1}{\sqrt{x+2}} dx$.

But, $\int \frac{1}{\sqrt{x+2}} dx = \int (x+2)^{-1/2} dx = 2(x+2)^{1/2} + c$ [Using the general power rule.]

Therefore, we have $y = f(x) = 2\sqrt{x+2} + c$.

Now, $f(2) = 3 \Rightarrow 3 = 2\sqrt{4} + c \Leftrightarrow c = -1$.

Therefore, $f(x) = 2\sqrt{x+2} - 1$.

EXAMPLE 22.12

The gradient at any point on the curve $y = f(x)$ is given by $5\sin(2x+3)$.

The curve passes through the point $(0, \frac{3}{2}\cos 3)$. Find the equation of this curve.

S
o
l
u
t
i
o
n

Given that $f'(x) = 5\sin(2x+3)$, then $f(x) = -\frac{5}{2}\cos(2x+3) + c$.

Now, we are given that $f(0) = \frac{3}{2}\cos 3 \therefore \frac{3}{2}\cos 3 = -\frac{5}{2}\cos(2 \times 0 + 3) + c$

$$\Leftrightarrow c = \frac{8}{2}\cos 3$$

Therefore, $f(x) = -\frac{5}{2}\cos(2x+3) + 4\cos 3$.

EXAMPLE 22.13

The rate of decay of a radioactive substance, Q , is given by $-200ke^{-kt}$.

Initially there were 200 milligrams of this substance. If the half-life of the substance is 1200 years, find the amount of the substance left after 2000 years. Sketch a graph of $Q(t)$.

S
o
l
u
t
i
o
n

We are given that $\frac{dQ}{dt} = -200ke^{-kt} \therefore Q = \frac{-200k}{-k}e^{-kt} + c$

$$Q = 200e^{-kt} + c$$

When $t = 0$, $Q = 200$, therefore $200 = 200 + c \Leftrightarrow c = 0$.

So that $Q(t) = 200e^{-kt}$, $t \geq 0$.

A half-life of 1200 years, this means that when $t = 1200$, $Q = 100$ (half its initial quantity).

That is, $100 = 200e^{-1200k} \Leftrightarrow e^{-1200k} = 0.5$

Therefore, $-1200k = \ln\left(\frac{1}{2}\right) \Leftrightarrow k = \frac{1}{1200}\ln 2$. That is, $Q(t) = 200e^{-\left(\frac{1}{1200}\ln 2\right)t}$, $t \geq 0$

$$\begin{aligned} \text{Then, when } t = 2000, Q(t) &= 200e^{-\left(\frac{1}{1200}\ln 2\right) \times 2000} \\ &= 200e^{-\frac{5}{3}\ln 2} \\ &= 62.996 \end{aligned}$$

That is, there will be approximately 63 milligrams.

EXERCISES 22.3

1. Find the indefinite integral of

- | | | | |
|----------------|------------------|------------------------|------------------|
| (a) e^{5x} | (b) e^{3x} | (c) e^{2x} | (d) $e^{0.1x}$ |
| (e) e^{-4x} | (f) $4e^{-4x}$ | (g) $0.1e^{-0.5x}$ | (h) $2e^{1-x}$ |
| (i) $5e^{x+1}$ | (j) $-2e^{2-2x}$ | (k) $e^{\frac{1}{3}x}$ | (l) $\sqrt{e^x}$ |

2. Find the indefinite integral of

- | | | | |
|--------------------|--------------------------------------|--|---------------------|
| (a) $\frac{4}{x}$ | (b) $-\frac{3}{x}$ | (c) $\frac{2}{5x}$ | (d) $\frac{1}{x+1}$ |
| (e) $\frac{1}{2x}$ | (f) $\left(1 - \frac{1}{x}\right)^2$ | (g) $\left(\sqrt{x} - \frac{1}{\sqrt{x}}\right)^2$ | (h) $\frac{3}{x+2}$ |

3. Find the indefinite integral of

- | | | | |
|----------------|----------------|------------------|----------------|
| (a) $\sin(3x)$ | (b) $\cos(2x)$ | (c) $\sec^2(5x)$ | (d) $\sin(-x)$ |
|----------------|----------------|------------------|----------------|

4. Find the indefinite integral of

- | | | |
|--|---|---|
| (a) $\sin(2x) + x$ | (b) $6x^2 - \cos(4x)$ | (c) e^{5x} |
| (d) $4e^{-3x} + \sin\left(\frac{1}{2}x\right)$ | (e) $\cos\left(\frac{x}{3}\right) - \sin(3x)$ | (f) $e^{2x} + \frac{4}{x} - 1$ |
| (g) $(e^x + 1)^2$ | (h) $-5\sin(4x) + \frac{x-1}{x}$ | (i) $\sec^2(3x) - \frac{2}{x} + e^{\frac{1}{2}x}$ |
| (j) $(e^x - e^{-x})^2$ | (k) e^{2x+3} | (l) $\sin(2x + \pi)$ |
| (m) $\cos(\pi - x)$ | (n) $\sin\left(\frac{1}{4}x + \frac{\pi}{2}\right)$ | (o) $\frac{e^x - 2}{\sqrt{e^x}}$ |

5. Using the general power rule, find the indefinite integral of

- | | | |
|------------------|------------------|-----------------|
| (a) $(4x - 1)^3$ | (b) $(3x + 5)^6$ | (c) $(2 - x)^4$ |
|------------------|------------------|-----------------|

MATHEMATICS – Higher Level (Core)

- (d) $(2x + 3)^5$ (e) $(7 - 3x)^8$ (f) $\left(\frac{1}{2}x - 2\right)^9$
 (g) $(5x + 2)^{-6}$ (h) $(9 - 4x)^{-2}$ (i) $(x + 3)^{-3}$
 (j) $\frac{1}{x + 1}$ (k) $\frac{2}{2x + 1}$ (l) $\frac{4}{3 - 2x}$
 (m) $\frac{-3}{5 - x}$ (n) $\frac{9}{3 - 6x}$ (o) $\frac{5}{3x + 2}$

6. Find the antiderivative of

- (a) $\sin(2x - 3) - 2x$ (b) $3 \cos\left(2 + \frac{1}{2}x\right) + 5$ (c) $\frac{1}{2} \cos\left(2 - \frac{1}{3}x\right) - \frac{2}{2x + 1}$
 (d) $\sec^2(0.1x - 5) - 2$ (e) $\frac{4}{2x + 3} - e^{-\frac{1}{2}x + 2}$ (f) $\frac{4}{(2x + 3)^2} - e^{2x - \frac{1}{2}}$
 (g) $\frac{x + 2}{x + 1} - \frac{4}{x + 2}$ (h) $\frac{2x + 1}{x + 2} + \frac{1}{2x + 1}$ (i) $\frac{2}{(2x + 1)^2} + \frac{2}{2x + 1}$

7. Find $f(x)$ given that

- (a) $f'(x) = \sqrt{4x + 5}$ where $f(-1) = \frac{1}{6}$.
 (b) $f'(x) = \frac{8}{4x - 3}$ where $f(1) = 2$.
 (c) $f'(x) = \cos(2x + 3)$ where $f\left(\pi - \frac{3}{2}\right) = 1$.
 (d) $f'(x) = 2 - e^{-2x + 1}$ where $f(0) = e$.

8. A bacteria population, N thousand, has a growth rate modelled by the equation

$$\frac{dN}{dt} = \frac{4000}{1 + 0.5t}, t \geq 0$$

where t is measured in days. Initially there are 250 bacteria in the population. Find the population size after 10 days.

9. The acceleration, in m/s^2 of a body in a medium is given by $\frac{dv}{dt} = \frac{3}{t + 1}, t \geq 0$.

The particle has an initial speed of 6 m/s, find the speed (to 2 d.p) after 10 seconds.

10. The rate of change of the water level in an empty container, t seconds after it started to be filled from a tap is given by the relation $\frac{dh}{dt} = 0.2\sqrt[3]{t + 8}, t \geq 0$, where h cm is the water level. Find the level of water after 6 seconds.**11.** The gradient function of the curve $y = f(x)$ is given by $e^{0.5x} - \cos(2x)$. Find the equation of the function, given that it passes through the origin.**12.** (a) Given that $\frac{d}{dx}(e^{ax}(p \sin bx + q \cos bx)) = e^{ax} \sin bx$, express p and q in terms of a and b .

(b) Hence find $\int e^{2x} \sin 3x dx$.

- 13.** The rate of change of the charge, Q , in coulombs, retained by a capacitor t minutes after charging is given by $\frac{dQ}{dt} = -ake^{-kt}$. Using the graph shown, determine the charge remaining after

- (a) one hour.
 (b) 80 minutes.

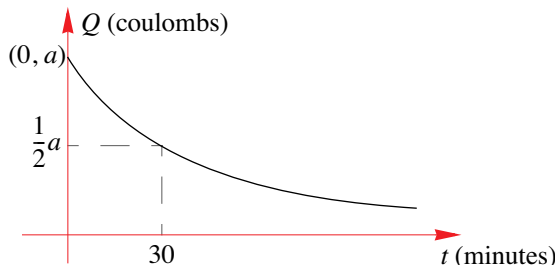

- 14.** (a) Show that $\frac{d}{dx}(x \ln(x+k)) = \frac{x}{x+k} + \ln(x+k)$, where k is a real number.
 (b) For a particular type of commercial fish, it is thought that a length-weight relationship exists such that their rate of change of weight, w kg, with respect to their length, x m, is modelled by the equation $\frac{dw}{dx} = 0.2 \ln(x+2)$.

Given that a fish in this group averages a weight of 650 gm when it is 20 cm long, find the weight of a fish measuring 30 cm.

- 15.** The rate of flow of water, $\frac{dV}{dt}$ litres/hour, pumped into a hot water system over a 24-hour period from 6:00 am, is modelled by the relation $\frac{dV}{dt} = 12 + \frac{3}{2} \cos \frac{\pi}{3} t$, $t \geq 0$.

- (a) Sketch the graph of $\frac{dV}{dt}$ against t .
 (b) For what percentage of the time will the rate of flow exceed 11 litres/hour?
 (c) How much water has been pumped into the hot water system by 8:00 am?

- 16.** The rates of change of the population size of two types of insect pests over a 4-day cycle, where t is measured in days, has been modelled by the equations

$$\frac{dA}{dt} = 2\pi \cos \pi t, t \geq 0$$

and
$$\frac{dB}{dt} = \frac{3}{4} e^{0.25t}, t \geq 0$$

where A and B represent the number of each type of pest in thousands. Initially there were 5000 insects of type A and 3000 insects of type B .

- (a) On the same set of axes sketch the graphs, $A(t)$ and $B(t)$ for $0 \leq t \leq 4$.
 (b) What is the maximum number of insects of type A that will occur?
 (c) When will there first be equal numbers of insects of both types?
 (d) For how long will the number of type B insects exceed the number of type A insects during the four days?

22.4 THE DEFINITE INTEGRAL

22.4.1 WHY THE DEFINITE INTEGRAL?

Unlike the previous section where the indefinite integral of an expression resulted in a new expression, when finding the **definite integral** we produce a **numerical value**.

Definite integrals are important because they can be used to find different types of measures, for example, areas, volumes, lengths and so on. It is, in essence, an extension of the work we have done in the previous sections.

22.4.2 LANGUAGE AND NOTATION

If the function $f(x)$ is continuous at every point on the interval $[a,b]$ and $F(x)$ is any

antiderivative of $f(x)$ on $[a,b]$, then $\int_a^b f(x)dx$ is called the **definite integral** and is equal to

$$F(b) - F(a) . \text{ That is, } \int_a^b f(x)dx = F(b) - F(a) .$$

Which is read as:

“the integral of $f(x)$ with respect to x from a to b is equal to $F(b) - F(a)$.”

Usually we have an intermediate step to aid in the evaluation of the definite integral, this provides a somewhat ‘compact recipe’ for the evaluation process. This intermediate step is written as

$$[F(x)]_a^b .$$

We therefore write

$$\int_a^b f(x)dx = [F(x)]_a^b = F(b) - F(a)$$

The process is carried out in 4 steps:

- Step 1** Find an indefinite integral of $f(x)$, $F(x)$ (say).
- Step 2** Write your result as $[F(x)]_a^b$.
- Step 3** Substitute a and b into $F(x)$
- Step 4** Subtract: $F(b) - F(a)$ to obtain the numerical value

Notice that the constant of integration c is omitted. This is because it would cancel itself out upon carrying out the subtraction: $(F(b) + c) - (F(a) + c) = F(b) - F(a)$.

In the expression $\int_a^b f(x)dx$, x is called the **variable of integration**, and a and b are called the

lower limit and **upper limit** respectively. It should also be noted that there is no reason why the number b need be greater than the number a when finding the definite integral. That is, it is just

as reasonable to write $\int_2^{-3} f(x)dx$ as it is to write $\int_{-3}^2 f(x)dx$, both expressions are valid.

EXAMPLE 22.14

Evaluate the following

$$\begin{array}{lll}
 \text{(a)} \quad \int_3^5 \frac{1}{x} dx & \text{(b)} \quad \int_2^4 \left(x + \frac{1}{x}\right)^2 dx & \text{(c)} \quad \int_0^1 \left(e^{2x} + \frac{3}{x+1}\right) dx \\
 \text{(d)} \quad \int_{\frac{\pi}{6}}^{\frac{\pi}{2}} \sin 3x dx & \text{(e)} \quad \int_5^2 (3x-4)^4 dx & \text{(f)} \quad \int_{-2}^0 (x - e^{-x}) dx
 \end{array}$$

Solution

$$\text{(a)} \quad \int_3^5 \frac{1}{x} dx = [\log_e x]_3^5 = \log_e 5 - \log_e 3 = \log_e \left(\frac{5}{3}\right) \approx 0.511$$

$$\begin{aligned}
 \text{(b)} \quad \int_2^4 \left(x + \frac{1}{x}\right)^2 dx &= \int_2^4 \left(x^2 + 2 + \frac{1}{x^2}\right) dx = \left[\frac{1}{3}x^3 + 2x - \frac{1}{x}\right]_2^4 \\
 &= \left(\frac{1}{3}(4)^3 + 2(4) - \frac{1}{4}\right) - \left(\frac{1}{3}(2)^3 + 2(2) - \frac{1}{2}\right) \\
 &= \left(\frac{64}{3} + 8 - \frac{1}{4}\right) - \left(\frac{8}{3} + 4 - \frac{1}{2}\right) \\
 &= \frac{275}{12} \quad (\approx 22.92)
 \end{aligned}$$

$$\begin{aligned}
 \text{(c)} \quad \int_0^1 \left(e^{2x} + \frac{3}{x+1}\right) dx &= \left[\frac{1}{2}e^{2x} + 3\log_e(x+1)\right]_0^1 = \left(\frac{1}{2}e^2 + 3\log_e 2\right) - \left(\frac{1}{2}e^0 + 3\log_e 1\right) \\
 &= \frac{1}{2}e^2 + 3\log_e 2 - \frac{1}{2} \\
 &\approx 5.27
 \end{aligned}$$

$$\text{(d)} \quad \int_{\frac{\pi}{6}}^{\frac{\pi}{2}} \sin 3x dx = \left[-\frac{1}{3}\cos 3x\right]_{\frac{\pi}{6}}^{\frac{\pi}{2}} = -\frac{1}{3}[\cos 3x]_{\frac{\pi}{6}}^{\frac{\pi}{2}} = -\frac{1}{3}\left(\cos\left(\frac{3\pi}{2}\right) - \cos\left(\frac{3\pi}{6}\right)\right) = 0$$

$$\text{(e)} \quad \int_5^2 (3x-4)^4 dx = \left[\frac{1}{3(5)}(3x-4)^5\right]_5^2 = \frac{1}{15}((2)^5 - (11)^5) = -\frac{161019}{15} = -10734.6$$

$$\text{(f)} \quad \int_{-2}^0 (x - e^{-x}) dx = \left[\frac{1}{2}x^2 + e^{-x}\right]_{-2}^0 = (0 + e^0) - \left(\frac{1}{2}(-2)^2 + e^2\right) = -1 - e^2 \approx -8.39$$

EXAMPLE 22.15

Differentiate $y = e^{x^2+3}$. Hence find the exact value of $\int_0^1 5xe^{x^2+3} dx$.

S
o
l
u
t
i
o
n

Differentiating we have, $\frac{d}{dx}(e^{x^2+3}) = 2xe^{x^2+3}$.

$$\begin{aligned} \text{Therefore, } \int_0^1 5xe^{x^2+3} dx &= \frac{5}{2} \int_0^1 2xe^{x^2+3} dx = \frac{5}{2} \int_0^1 \frac{d}{dx}(e^{x^2+3}) dx \\ &= \frac{5}{2} [e^{x^2+3}]_0^1 = \frac{5}{2}(e^4 - e^3) \end{aligned}$$

Notice that in this case we made use of the fact that if $f'(x) = g(x)$ then $\int g(x) dx = f(x) + c$.

The above definite integrals can also be found using the **fnInt** function on the TI-83, although it would not provide an exact answer.

First, use the **MATH** menu and then select the **fnInt** command. Enter the equation of the integrand, the variable, and then the lower and upper limits.

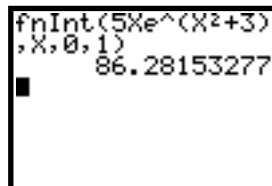
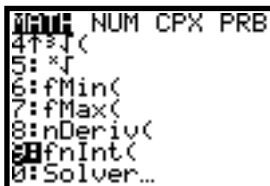

EXAMPLE 22.16

The production rate for radios by the average worker at Bat-Rad Pty Ltd t hours after starting work at 7:00 am, is given by $N'(t) = -2t^2 + 8t + 10, 0 \leq t \leq 4$. How many units can the average worker assemble in the second hour of production.

S
o
l
u
t
i
o
n

The second hour starts at $t = 1$ and ends at $t = 2$. Therefore, the number of radios assembled by the

average worker in the second hour of production is given by $N = \int_{t=1}^{t=2} N'(t) dt$

$$\begin{aligned} \text{That is, } N &= \int_1^2 (-2t^2 + 8t + 10) dt = \left[-\frac{2}{3}t^3 + 4t^2 + 10t \right]_1^2 \\ &= \left(-\frac{2}{3}(2)^3 + 4(2)^2 + 10(2) \right) - \left(-\frac{2}{3}(1)^3 + 4(1)^2 + 10(1) \right) \\ &= \frac{52}{3} \end{aligned}$$

Note that to evaluate the definite integral we made use of the graphics calculator:

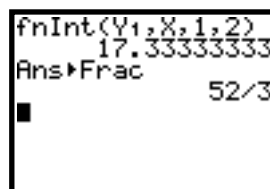
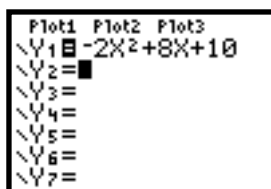

22.4.3 PROPERTIES OF THE DEFINITE INTEGRAL

There are a number of simple but very important properties of the definite integral (many of which we have already used). Some of these properties are summarised below (this list is not an exhaustive list) and it is assumed that the integrand, $f(x)$ is continuous on $[a, b]$ and that the

definite integral, $\int_a^b f(x) dx$ is finite.

Property	Examples
1. $\int_a^a f(x) dx = 0$	$\int_2^2 (x+1) dx = \left[\frac{x^2}{2} + x \right]_2^2 = \left(\frac{(2)^2}{2} + (2) \right) - \left(\frac{(2)^2}{2} + (2) \right) = 0$
2. $\int_a^b f(x) dx = -\int_b^a f(x) dx$	$\int_1^2 e^{3x} dx = \left[\frac{1}{3} e^{3x} \right]_1^2 = \frac{1}{3} (e^6 - e^3)$ $\int_2^1 e^{3x} dx = \left[\frac{1}{3} e^{3x} \right]_2^1 = \frac{1}{3} (e^3 - e^6) = -\frac{1}{3} (e^6 - e^3)$ $= -\int_1^2 e^{3x} dx$
3. $\int_a^b f(x) dx = \int_a^c f(x) dx + \int_c^b f(x) dx$ where $a \leq c \leq b$.	$\int_2^5 \frac{1}{x} dx = [\ln x]_2^5 = \ln 5 - \ln 2 = \ln 2.5$ $\int_2^3 \frac{1}{x} dx + \int_3^5 \frac{1}{x} dx = [\ln x]_2^3 + [\ln x]_3^5$ $= (\ln 3 - \ln 2) + (\ln 5 - \ln 3)$ $= \ln 5 - \ln 2 = \ln 2.5$
4. $\int_a^b kf(x) dx = k \int_a^b f(x) dx, k \in \mathbb{R}$	$\int_0^{\frac{\pi}{4}} 3 \cos(2x) dx = 3 \int_0^{\frac{\pi}{4}} \cos(2x) dx = 3 \left[\frac{1}{2} \sin(2x) \right]_0^{\frac{\pi}{4}} = \frac{3}{2}$
5. $\int_a^b (f(x) \pm g(x)) dx = \int_a^b f(x) dx \pm \int_a^b g(x) dx$	$\int_1^3 (x + e^{-2x}) dx = \left[\frac{1}{2} x^2 - \frac{1}{2} e^{-2x} \right]_1^3 = \frac{1}{2} (8 - e^{-6} + e^{-2})$ Similarly, $\int_1^3 x dx + \int_1^3 e^{-2x} dx = \left[\frac{1}{2} x^2 \right]_1^3 + \left[-\frac{1}{2} e^{-2x} \right]_1^3 = \frac{1}{2} (8 - e^{-6} + e^{-2})$

The use of these properties relies on your ability to recognise their appropriateness in any given situation.

EXAMPLE 22.17

Suppose that $f(x)$ and $g(x)$ are continuous functions on the interval $[1, 5]$

and that $\int_1^3 f(x)dx = -2$, $\int_1^5 f(x)dx = 7$, $\int_1^3 g(x)dx = 3$ and $\int_1^5 g(x)dx = 5$.

Evaluate the following

- (a) $\int_1^3 (3f(x) - g(x))dx$ (b) $\int_5^1 (f(x) - g(x))dx$ (c) $\int_1^3 (5 - 4f(x))dx$

S
o
l
u
t
i
o
n

- (a) $\int_1^3 (3f(x) - g(x))dx = \int_1^3 3f(x)dx - \int_1^3 g(x)dx = 3\int_1^3 f(x)dx - 3 = 3 \times (-2) - 3 = -9$
- (b) $\int_5^1 (f(x) - g(x))dx = \int_5^1 f(x)dx - \int_5^1 g(x)dx = -\int_1^5 f(x)dx - \left(-\int_1^5 g(x)dx\right) = -(7) + 5 = -2$
- (c) $\int_1^3 (5 - 4f(x))dx = \int_1^3 5dx - 4\int_1^3 f(x)dx = [5x]_1^3 - 4(-2) = (15 - 5) + 8 = 18$

EXAMPLE 22.18

Find the value(s) of m , where

- (a) $\int_0^m (2x - 4)dx = -4$ (b) $\int_0^m (2x - 4)dx = 5$

S
o
l
u
t
i
o
n

- (a) $\int_0^m (2x - 4)dx = -4 \Rightarrow [x^2 - 4x]_0^m = -4 \Leftrightarrow m^2 - 4m = -4$
 $\Leftrightarrow m^2 - 4m + 4 = 0$
 $\Leftrightarrow (m - 2)^2 = 0 \Leftrightarrow m = 2.$
- (b) $\int_0^m (2x - 4)dx = 5 \Leftrightarrow m^2 - 4m = 5 \Leftrightarrow m^2 - 4m - 5 = 0$
 $\Leftrightarrow (m - 5)(m + 1) = 0$
 $\Leftrightarrow m = 5$ or $m = -1$

Notice that **both** solutions must be given.

EXAMPLE 22.19

Evaluate

- (a) $\int_1^3 \sqrt{2x + 3} dx$ (b) $\int_0^k \frac{2}{(3 - 2x)^2} dx, k < \frac{3}{2}$

$$\begin{aligned}
 \text{(a)} \quad \int_1^3 \sqrt{2x+3} \, dx &= \int_1^3 (2x+3)^{1/2} \, dx = \left[\frac{1}{2 \times \left(\frac{1}{2} + 1\right)} (2x+3)^{\frac{1}{2}+1} \right]_1^3 \quad [\text{Using power rule}]. \\
 &= \left[\frac{1}{3} (2x+3)^{\frac{3}{2}} \right]_1^3 \\
 &= \frac{1}{3} [(9^{3/2}) - 5^{3/2}] \\
 &= \frac{1}{3} (27 - 5\sqrt{5})
 \end{aligned}$$

$$\begin{aligned}
 \text{(b)} \quad \int_0^k \frac{2}{(3-2x)^2} \, dx &= \int_0^k 2(3-2x)^{-2} \, dx = 2 \left[\frac{1}{-2 \times -1} (3-2x)^{-1} \right]_0^k = \left[\frac{1}{3-2x} \right]_0^k \\
 &= \frac{1}{3-2k} - \frac{1}{3} \\
 &= \frac{2k}{3(3-2k)}
 \end{aligned}$$

EXERCISES 22.4

1. Evaluate the following

$$\begin{array}{llll}
 \text{(a)} \quad \int_1^4 x \, dx & \text{(b)} \quad \int_4^9 \sqrt{x} \, dx & \text{(c)} \quad \int_2^3 \frac{2}{x^3} \, dx & \text{(d)} \quad \int_{16}^9 \frac{4}{\sqrt{x}} \, dx
 \end{array}$$

2. Evaluate the following definite integrals (giving exact answers)

$$\begin{array}{lll}
 \text{(a)} \quad \int_1^2 \left(x^2 - \frac{3}{x^4} \right) dx & \text{(b)} \quad \int_0^2 (x\sqrt{x} - x) dx & \text{(c)} \quad \int_0^2 (1 + 2x - 3x^2) dx \\
 \text{(d)} \quad \int_{-2}^1 (x+1) dx & \text{(e)} \quad \int_0^1 x^3(x+1) dx & \text{(f)} \quad \int_{-1}^1 (x+1)(x^2-1) dx \\
 \text{(g)} \quad \int_1^4 (\sqrt{x}-1)^2 dx & \text{(h)} \quad \int_1^2 \left(x - \frac{1}{x} \right)^2 dx & \text{(i)} \quad \int_1^3 \left(\frac{x^3 - x^2 + x}{x} \right) dx \\
 \text{(j)} \quad \int_{-1}^1 (x - x^3) dx & \text{(k)} \quad \int_1^4 \frac{x+1}{\sqrt{x}} dx & \text{(l)} \quad \int_1^4 \left(\sqrt{\frac{2}{x}} - \sqrt{\frac{x}{2}} \right) dx
 \end{array}$$

3. Use a graphics calculator to check your answers to Question 2.

MATHEMATICS – Higher Level (Core)

4. Evaluate the following definite integrals (giving exact values)

$$\begin{array}{lll}
 \text{(a)} & \int_0^1 (e^x + 1) dx & \text{(b)} & \int_1^2 \frac{4}{e^{2x}} dx & \text{(c)} & \int_{-1}^1 (e^x - e^{-x}) dx \\
 \text{(d)} & \int_{-1}^1 (e^x + e^{-x}) dx & \text{(e)} & \int_{-1}^1 (e^x + e^{-x})^2 dx & \text{(f)} & \int_2^0 e^{2x+1} dx \\
 \text{(g)} & \int_0^1 (\sqrt{e^x} - 1) dx & \text{(h)} & \int_0^1 (e^{\frac{1}{4}x} - e^{4x}) dx & \text{(i)} & \int_1^{-1} e^{1-2x} dx
 \end{array}$$

5. Use a graphics calculator to check your answers to Question 4.

6. Evaluate the following definite integrals (giving exact values)

$$\begin{array}{lll}
 \text{(a)} & \int_1^3 \frac{3}{x} dx & \text{(b)} & \int_0^4 \frac{2}{x+1} dx & \text{(c)} & \int_2^6 \frac{x+4}{x} dx \\
 \text{(d)} & \int_4^5 \left(x^2 + \frac{1}{x}\right)^2 dx & \text{(e)} & \int_{-1}^0 \frac{3}{1-2x} dx & \text{(f)} & \int_0^1 \frac{2}{x+1} dx \\
 \text{(g)} & \int_0^1 \frac{2}{(x+1)^3} dx & \text{(h)} & \int_2^4 \left(\sqrt{x} - \frac{2}{\sqrt{x}}\right)^2 dx & \text{(i)} & \int_3^4 \frac{2x+1}{2x^2-3x-2} dx
 \end{array}$$

7. Use a graphics calculator to check your answers to Question 6.

8. Evaluate the following definite integrals (giving exact values)

$$\begin{array}{lll}
 \text{(a)} & \int_0^{\frac{\pi}{2}} \sin(2x) dx & \text{(b)} & \int_{-\pi}^0 \cos\left(\frac{1}{3}x\right) dx & \text{(c)} & \int_{\frac{\pi}{6}}^{\frac{\pi}{3}} \sec^2 4x dx \\
 \text{(d)} & \int_0^{\pi} \left(\cos x - \sin\left(\frac{x}{2}\right)\right) dx & \text{(e)} & \int_0^{\frac{\pi}{4}} (x - \sec^2 x) dx & \text{(f)} & \int_0^{\frac{\pi}{2}} 2 \cos\left(4x + \frac{\pi}{2}\right) dx \\
 \text{(g)} & \int_{-\pi}^{\pi} \left(\sin\left(\frac{x}{2}\right) + 2 \cos(x)\right) dx & \text{(h)} & \int_0^{\frac{\pi}{12}} \sec^2\left(\frac{\pi}{4} - 2x\right) dx & \text{(i)} & \int_0^{\pi} \cos(2x + \pi) dx
 \end{array}$$

9. Evaluate the following definite integrals (giving exact values)

$$\begin{array}{lll}
 \text{(a)} & \int_0^1 (x+1)^4 dx & \text{(b)} & \int_1^3 \sqrt{2x+1} dx & \text{(c)} & \int_{-1}^2 (1-2x)^3 dx \\
 \text{(d)} & \int_0^1 \frac{1}{(x+2)^3} dx & \text{(e)} & \int_5^8 \frac{1}{\sqrt[3]{x-4}} dx & \text{(f)} & \int_0^1 \frac{x}{(1+x)} dx
 \end{array}$$

10. Show that $\frac{2x+6}{x^2+6x+5} \equiv \frac{1}{x+1} + \frac{1}{x+5}$. Hence evaluate $\int_0^2 \frac{2x+6}{x^2+6x+5} dx$

11. Find $\frac{d}{dx}(x \sin 2x)$. Hence find the exact value of $\int_0^{\pi} x \cos 2x dx$.

12. Given that $\int_a^b f(x)dx = m$ and $\int_a^b g(x)dx = n$, find

(a) $\int_a^b 2f(x)dx - \int_a^b g(x)dx$ (b) $\int_a^b (f(x) - 1)dx$ (c) $\int_b^a 3g(x)dx$

(d) $\int_a^b (af(x) - m)dx$ (e) $\int_a^b (b^2g(x) - 2nx)dx$

13. (a) Find $\frac{d}{dx}(xe^{0.1x})$. Hence, find $\int xe^{0.1x}dx$.

(b) Following an advertising initiative by the Traffic Authorities, preliminary results predict that the number of alcohol-related traffic accidents has been decreasing at a rate of $-12 - te^{0.1t}$ accidents per month, where t is the time in months since the advertising campaign started.

- i. How many accidents were there over the first six months of the campaign.
- ii. In the year prior to the advertising campaign there were 878 alcohol-related traffic accidents. Find an expression for the total number of accidents since the start of the previous year, t months after the campaign started.

14. The rate of Cable television subscribers in a city t years from 1995 has been modelled by the equation $\frac{2000}{\sqrt{(1 + 0.4t)^3}}$.

- (a) How many subscribers were there between 1998 and 2002?
- (b) If there were initially 40,000 subscribers, find the number of subscribers by 2010.

15. (a) Find $\frac{d}{dt}\left(\frac{800}{1 + 24e^{-0.02t}}\right)$.

(b) The rate at which the number of fruit flies appear when placed in an environment with limited food supply in an experiment was found to be approximated by the exponential model $\frac{384e^{-0.02t}}{(1 + 24e^{-0.02t})^2}$, $t \geq 0$, where t is the number of days since the experiment started. What was the increase in the number of flies after 200 days?

22.5 APPLICATIONS OF INTEGRATION

In Chapters 20 and 21 we saw that differentiation had a geometric meaning, that is, it provided a measure of the gradient of the curve at a particular point. We have also seen applications of the definite integral throughout the previous sections in this chapter. In this section we will investigate the geometric significance of the integral.

22.5.1 INTRODUCTION TO THE AREA BENEATH A CURVE

Consider the problem of finding the exact value of the shaded area, A sq. units, in the diagram shown.

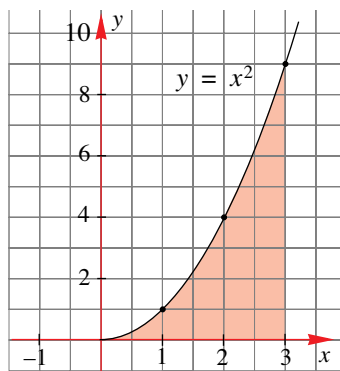

As a first step we make use of rectangular strips as shown below to obtain an approximation of the shaded area. We can set up a table of values, use it to find the area of each strip and then sum these areas.

In Figure 1, the rectangles lie below the curve, and so we call these the **lower rectangles**. In Figure 2, the rectangles lie above the curve, and so we call these the **upper rectangles**. Figure 3 shows that the true area (or exact area) lies somewhere between the sum of the areas of the lower rectangles, S_L , and the sum of the areas of the upper rectangles, S_U .

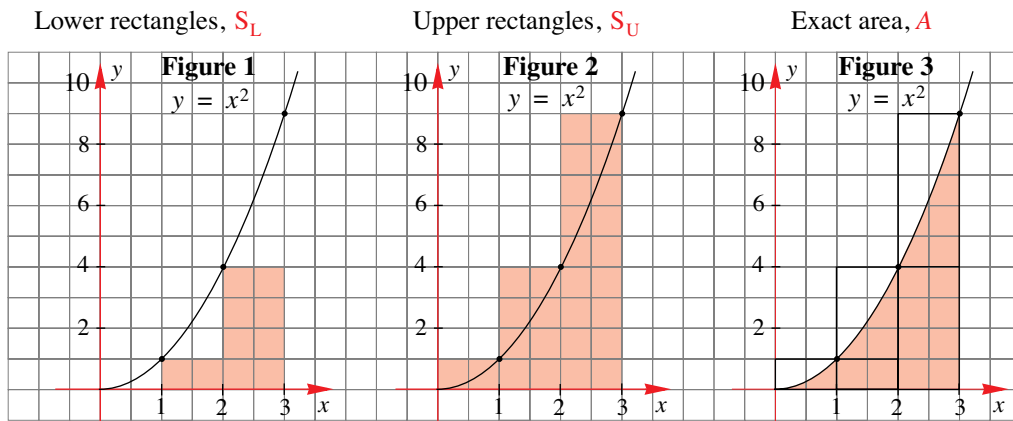

That is, we have that

$$\text{Lower Sum} = S_L < \text{Exact Area, } A < S_U = \text{Upper Sum}$$

In the case above we have that $S_L = 1 \times 1 + 1 \times 4 = 5$ and $S_U = 1 \times 1 + 1 \times 4 + 1 \times 9 = 14$.

Therefore, we can write $5 < A < 14$. However, this does seem to be a poor approximation as there is a difference of 9 sq. units between the lower approximation and the upper approximation. The problem lies in the fact that we have only used two rectangles for the lower sum and three rectangles for the upper sum. We can improve on our approximation by increasing the number of rectangles that are used. For example, we could use 5 lower rectangles and 6 upper rectangles, or 10 lower rectangles and 12 upper rectangles and so on.

22.5.2 IN SEARCH OF A BETTER APPROXIMATION

As shown in the diagrams below, as we increase the number of rectangular strips (or decrease the width of each strip) we obtain better approximations to the exact value of the area.

5 lower & 6 upper rectangles

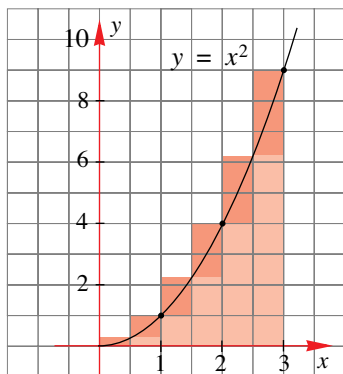

10 lower & 12 upper rectangles

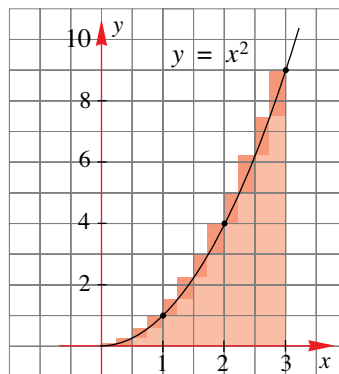

We can make use of a table of values to find the sum of the areas of the lower and upper rectangles:

Using intervals of width $\frac{1}{2}$ units.

X	Y_1	
0	0	
.5	.25	
1	1	
1.5	2.25	
2	4	
2.5	6.25	
3	9	
X=0		

Using intervals of width $\frac{1}{4}$ units.

X	Y_1	
0	0	
.25	.0625	
.5	.25	
.75	.5625	
1	1	
1.25	1.5625	
1.5	2.25	
X=0		

For intervals of width 0.5 we have:

$$S_L = \frac{1}{2} \times [0.25 + 1 + 2.25 + 4 + 6.25] = 6.875$$

$$S_U = \frac{1}{2} \times [0.25 + 1 + 2.25 + 4 + 6.25 + 9] = 11.375$$

} i.e., $6.88 < A < 11.38$

For intervals of width 0.25 we have:

$$S_L = \frac{1}{4} \times [0.25 + 0.5625 + 1 + 1.5625 + 2.25 + \dots + 7.5625] \approx 7.89$$

$$S_U = \frac{1}{4} \times [0.0625 + 0.25 + 0.5625 + \dots + 7.5625 + 9] \approx 10.16$$

} i.e., $7.89 < A < 10.16$

By continuing in this manner, the value of A will become *sandwiched* between a lower value and an upper value. Of course the more intervals we have the ‘tighter’ the sandwich will be! What we can say is that if we partition the interval $[0, 3]$ into n equal subintervals, then, as the number of rectangles increases, S_L increases towards the exact value A while S_U decreases towards the exact value A . That is,

$$\lim_{n \rightarrow \infty} S_L = A = \lim_{n \rightarrow \infty} S_U$$

As we have seen, even for a simple case such as $y = x^2$, this process is rather tedious. And as yet, we still have not found the exact area of the shaded region under the curve $y = x^2$ over the interval $[0, 3]$.

22.5.3 TOWARDS AN EXACT AREA

We can produce an algebraic expression to determine the exact area enclosed by a curve. We shall also find that the definite integral plays a large part in determining the area enclosed by a curve.

As a starting point we consider a single rectangular strip.

Consider the function $y = f(x)$ as shown:

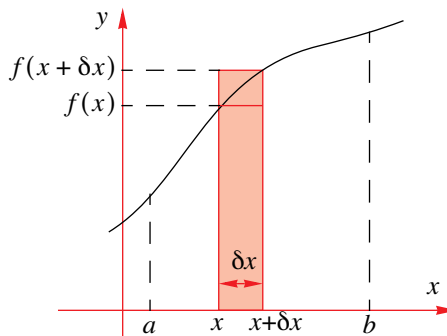

Divide the interval from $x = a$ to $x = b$ into n equal parts: $a = x_0, x_1, x_2, \dots, x_n = b$.

This means that each strip is of width $\frac{b-a}{n}$.

We denote this width by δx so that $\delta x = \frac{b-a}{n}$.

The area of the lower rectangle is $f(x) \times \delta x$ and that of the upper rectangle is $f(x + \delta x) \times \delta x$.

Then, the sum of the areas of the lower rectangles for $a \leq x \leq b$ is $S_L = \sum_{x=a}^{b-\delta x} f(x)\delta x$

and the sum of the areas of the upper rectangles for $a \leq x \leq b$ is $S_U = \sum_{x=a}^b f(x + \delta x)\delta x$

Then, if A sq units is the area under the curve $y = f(x)$ over the interval $[a, b]$ we have that

$$\sum_{x=a}^{b-\delta x} f(x)\delta x < A < \sum_{x=a}^b f(x + \delta x)\delta x$$

As the number of strips increase, that is, as $n \rightarrow \infty$ and therefore $\delta x \rightarrow 0$ the area, A sq units, approaches a common limit, i.e., S_L from below, and S_U from above. We write this result as:

$$A = \lim_{\delta x \rightarrow 0} \sum_{x=a}^b f(x)\delta x$$

In fact this result leads to the use of the integral sign as a means whereby we can find the required area.

That is,

$$\lim_{\delta x \rightarrow 0} \sum_{x=a}^b f(x)\delta x = \int_a^b f(x)dx$$

Notice that we've only developed an appropriate notation and a 'recognition' that the definite integral provides a numerical value whose geometrical interpretation is connected to the area enclosed by a curve, the x -axis and the lines $x = a$ and $x = b$. We leave out a formal proof of this result in preference to having developed an intuitive idea behind the concept and relationship between area and the definite integral.

We can now combine our results of the definite integral with its geometrical significance in relation to curves on a Cartesian set of axes.

22.5.4 THE DEFINITE INTEGRAL AND AREAS

If $y = f(x)$ is **positive** and **continuous** on the interval $[a, b]$, the area, A sq units, bounded by $y = f(x)$, the x -axis and the lines $x = a$ and $x = b$ is given by

$$\text{Area} = A = \int_a^b f(x) dx = \int_a^b y dx$$

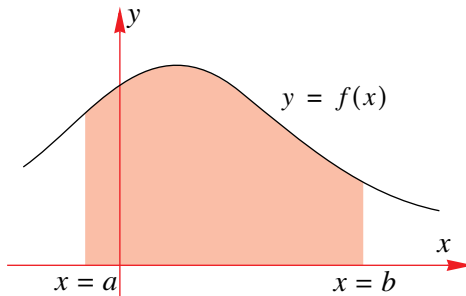
EXAMPLE 22.20

Find the area of the shaded region shown below.

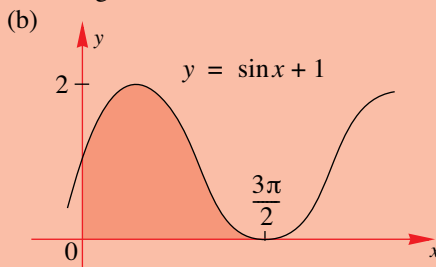
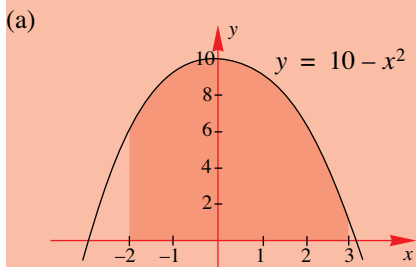

S
o
l
u
t
i
o
n

(a) $\text{Area} = \int_{-2}^3 (10 - x^2) dx = \left[10x - \frac{1}{3}x^3 \right]_{-2}^3 = \left((30 - 9) - \left(-20 + \frac{8}{3} \right) \right) = \frac{115}{3}$

Therefore, the shaded area measures $\frac{115}{3}$ square units.

(b) $\text{Area} = \int_0^{\frac{3\pi}{2}} (\sin x + 1) dx = [-\cos x + x]_0^{\frac{3\pi}{2}} = \left(-\cos\left(\frac{3\pi}{2}\right) + \frac{3\pi}{2} \right) - (-\cos(0) + 0)$
 $= \frac{3\pi}{2} + 1$

Therefore, the shaded area measures $\frac{3\pi}{2} + 1$ square units.

Apart from having the ability to ‘find’ an indefinite integral, or rather, sketch an indefinite integral, the TI-83 can also display the shaded regions required.

This is done by using the **Shade** command from the **DRAW** function.

```

0:QUIT POINTS STO
1:ClrDraw
2:Line(
3:Horizontal
4:Vertical
5:Tangent(
6:DrawF
7:Shade(
    
```

```

Shade(█
    
```

EXAMPLE 22.21

Find the area enclosed by the curve with equation $f(x) = 2 + x^2$, the x -axis and the lines $x = 1$ and $x = 3$.

S
o
l
u
t
i
o
n

Using the **DRAW** function, and then selecting **Shade**, we enter the required information, i.e., 0 (for $y = 0$, i.e., the x -axis), the equation of the function, the lower limit and then, the upper limit (do not forget to first enter the equation in the equation editor screen and to enter the appropriate window setting.) To find the measure of the area, we need to use the **fnInt** function:

1. Set up graph

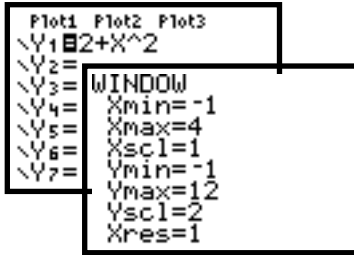

2. Display required region

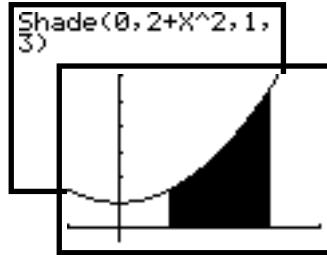

3. Find numerical value

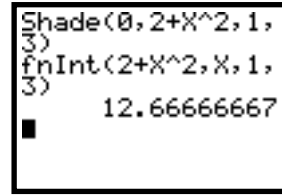

i.e., area is $12\frac{2}{3}$ sq units.

E
x
a
m
p
l
e
22.22

The area enclosed by the curve with equation $y = 4 - e^{-0.5x}$, the x -axis, the y -axis and the line $x = -2$, measures $k - 2e$ sq units. Find the value of k .

S
o
l
u
t
i
o
n

Using the TI-83 to first visualise the situation we have:

Therefore, we have $\int_{-2}^0 (4 - e^{-0.5x}) dx = k - 2e$

$$[4x + 2e^{-0.5x}]_{-2}^0 = k - 2e$$

$$2 - (-8 + 2e^1) = k - 2e$$

$$10 - 2e = k - 2e$$

Therefore, $k = 10$.

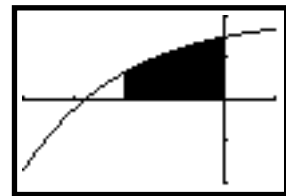

22.5.5 FURTHER OBSERVATIONS ABOUT AREAS

1. To find the area bounded by $y = f(x)$, the y -axis and the lines $y = a$ and $y = b$ we carry out the following process:

1. First you need to make x the subject, i.e., from $y = f(x)$ obtain the new equation $x = g(y)$.
2. Then find the definite integral,

$$\int_a^b x dy = \int_a^b g(y) dy \text{ sq units.}$$

which will give the shaded area.

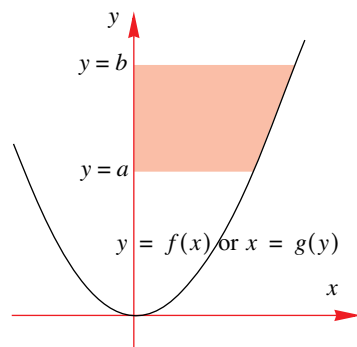

2. If f is **negative** over the interval $[a, b]$ (i.e. $f(x) < 0$ for $a \leq x \leq b$), then the integral $\int_a^b f(x) dx$ is a negative number.

We therefore need to write the area, A , as

$$A = -\int_a^b f(x) dx$$

or, use the **absolute value** of the integral:

$$A = \left| \int_a^b f(x) dx \right|.$$

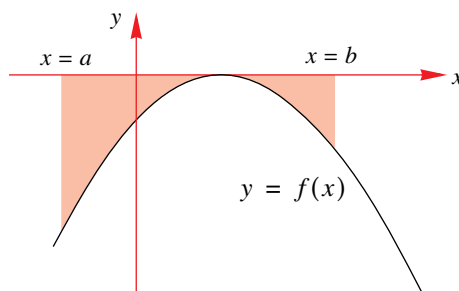

EXAMPLE 22.23

Find the area enclosed by the curve $y = \sqrt{x}$, the y -axis and the lines $y = 1$ and $y = 3$.

S
O
L
I
T
I
O
N

We begin by showing the required region on the cartesian plane:

Next we need an expression for x in terms of y :

That is, $y = \sqrt{x} \Rightarrow y^2 = x, x > 0$

Therefore, the area of the shaded region is

$$A = \int_1^3 x dy = \int_1^3 y^2 dy = \left[\frac{1}{3} y^3 \right]_1^3 = \frac{1}{3} (3^3 - 1^3) = \frac{26}{3}$$

So that the required area is $\frac{26}{3}$ sq units.

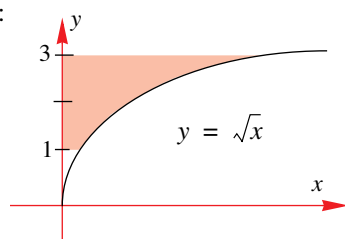

22.5.6 THE SIGNED AREA

It is possible for $y = f(x)$ to alternate between negative and positive values over the interval $x = a$ and $x = b$. That is there is at least one point $x = c$ where the graph crosses the x -axis, and so $y = f(x)$ changes sign when it crosses the point $x = c$.

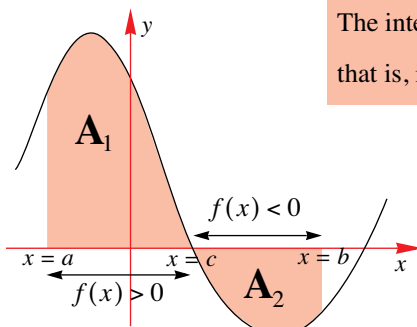

The integral $\int_a^b f(x) dx$ gives the **algebraic sum** of A_1 and A_2 , that is, it gives the **signed area**.

For example, if $A_1 = 12$ and $A_2 = 4$, then the definite

$$\text{integral } \int_a^b f(x) dx = 12 - 4 = 8.$$

This is because $\int_a^c f(x) dx = 12$, $\int_c^b f(x) dx = -4$ and so

$$\int_a^b f(x) dx = \int_a^c f(x) dx + \int_c^b f(x) dx = 12 + (-4) = 8$$

MATHEMATICS – Higher Level (Core)

As $\int_c^b f(x)dx$ is a negative value, finding the negative of $\int_c^b f(x)dx$, that is $\left(-\int_c^b f(x)dx\right)$,

would provide a positive value and therefore be a measure of the area of the region that is shaded below the x -axis.

The shaded area would then be given by $\int_a^c f(x)dx + \left(-\int_c^b f(x)dx\right)$.

This would provide the sum of two positive numbers.

22.5.7 STEPS FOR FINDING AREAS

It follows, that in order to find the area bounded by the curve $y = f(x)$, the x -axis and the lines $x = a$ and $x = b$, we first need to find where (and if) the curve crosses the x -axis at some point $x = c$ in the interval $a \leq x \leq b$. If it does, we must evaluate the area of the regions above and below the x -axis **separately**. Otherwise, evaluating $\int_a^b f(x)dx$ will provide the signed area (which only gives the correct area if the function lies above the x -axis over the interval $a \leq x \leq b$).

Therefore, we need to:

- 1.** **Sketch** the graph of the curve $y = f(x)$ over the interval $a \leq x \leq b$.
(In doing so you will also determine any x -intercepts).
- 2.** **Integrate** $y = f(x)$ **over each region separately** (if necessary).
(That is, regions above the x -axis and regions below the x -axis)
- 3.** Add the required (positive terms).

EXAMPLE 22.24

Find the area of the region enclosed by the curve $y = x^3 - 1$, the x -axis and $0 \leq x \leq 2$.

S
o
l
u
t
i
o
n

First sketch the graph of the given curve: x -intercepts (when $y = 0$): $x^3 - 1 = 0 \Leftrightarrow x = 1$.
 y -intercepts (when $x = 0$): $y = 0 - 1 = -1$.

From the graph we see that y is negative in the region $[0,1]$ and positive in the region $[1,2]$, therefore the area of the region enclosed is given by

$$\begin{aligned} A &= \left(-\int_0^1 (x^3 - 1)dx\right) + \int_1^2 (x^3 - 1)dx = \left(-\left[\frac{x^4}{4} - x\right]_0^1\right) + \left[\frac{x^4}{4} - x\right]_1^2 \\ &= -\left(-\frac{3}{4}\right) + \left((2) - \left(-\frac{3}{4}\right)\right) \\ &= 3.5 \end{aligned}$$

That is, the area measures 3.5 sq units.

Notice that $\int_0^2 (x^3 - 1)dx = \left[\frac{x^4}{4} - x\right]_0^2 = 2$ ($\neq 3.5$).

Using the **CALC** option after sketching the curve $y = x^3 - 1$ on the TI-83, we can visualise these results more readily.

Signed area:

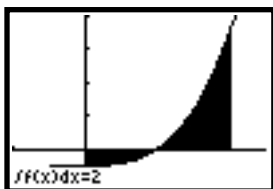

$$\int_0^2 (x^3 - 1) dx = 2$$

Actual area:

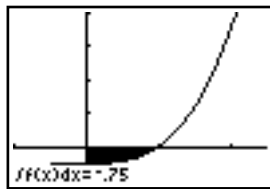

$$A = \left(-\int_0^1 (x^3 - 1) dx\right) + \int_1^2 (x^3 - 1) dx = -(-0.75) + 2.75 = 3.5$$



EXAMPLE 22.25

Find the area enclosed by the curve $y = x^3 - 3x^2 + 2x$, the x -axis and the lines $x = 0$ and $x = 3$.

S
o
l
u
t
i
o
n

First sketch the graph of the given curve:

x -intercepts (when $y = 0$): $x^3 - 3x^2 + 2x = 0 \Leftrightarrow x(x-2)(x-1) = 0 \therefore x = 0, 2, 1$

y -intercepts (when $x = 0$): $y = 0 - 0 + 0 = 0$.

From the diagram we have, Area = $A_1 - A_2 + A_3$.

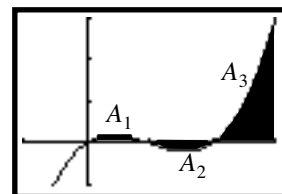

$$\text{Now, } A_1 = \int_0^1 (x^3 - 3x^2 + 2x) dx = \left[\frac{x^4}{4} - x^3 + x^2 \right]_0^1 = \frac{1}{4}$$

$$A_2 = \int_1^2 (x^3 - 3x^2 + 2x) dx = \left[\frac{x^4}{4} - x^3 + x^2 \right]_1^2 = -\frac{1}{4}$$

$$\text{and } A_3 = \int_2^3 (x^3 - 3x^2 + 2x) dx = \left[\frac{x^4}{4} - x^3 + x^2 \right]_2^3 = \frac{9}{4}$$

$$\text{NB: } \int_0^3 (x^3 - 3x^2 + 2x) dx = \frac{9}{4}$$

Therefore, the required area is $\frac{1}{4} - \left(-\frac{1}{4}\right) + \frac{9}{4} = \frac{11}{4}$ sq units.

22.5.8 AREA BETWEEN TWO CURVES

The use of the definite integral in finding the area of a region enclosed by a single curve can be extended to finding the area enclosed between two curves. Although we do have a compact formula to find such areas, in reality it is a simple geometrical observation.

Consider two continuous functions, $f(x)$ and $g(x)$ on some interval $[a, b]$, such that over this interval, $g(x) \geq f(x)$. The area of the region enclosed by these two curves and the lines $x = a$ and $x = b$ is shown next.

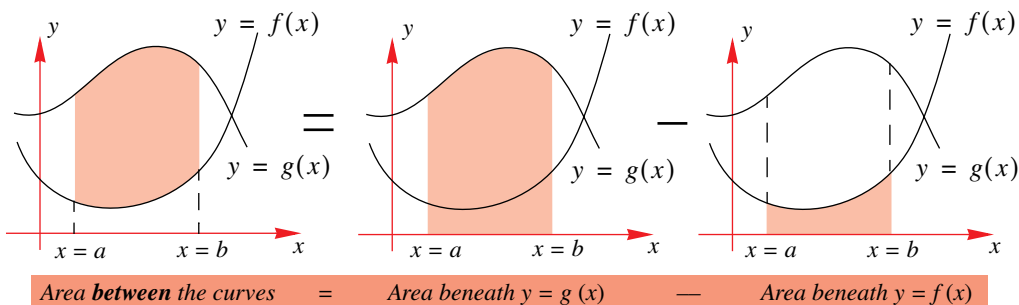

That is,

If $g(x) \geq f(x)$ on the interval $[a,b]$, then the area, A square units, enclosed by the two curves and the lines $x = a$ and $x = b$ is given by

$$A = \int_a^b g(x)dx - \int_a^b f(x)dx = \int_a^b (g(x) - f(x))dx$$

EXAMPLE 22.26

Find the area of the region enclosed by the curves $g(x) = x + 2$, $f(x) = x^2 + x - 2$ and the lines $x = -1$ and $x = 1$.

Solution

The first step is to sketch both graphs so that it is clear which one lies above the other. In this case, as $g(x) \geq f(x)$ on $[-1,1]$, we can write the required area, A sq units, as

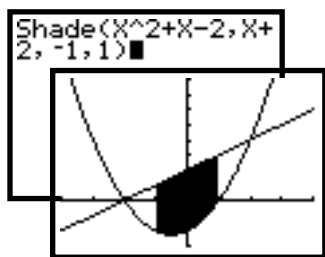

$$\begin{aligned} \int_{-1}^1 ((x + 2) - (x^2 + x - 2))dx &= \int_{-1}^1 (4 - x^2)dx \\ &= \left[4x - \frac{x^3}{3} \right]_{-1}^1 \\ &= \left(4 - \frac{1}{3} \right) - \left(-4 + \frac{1}{3} \right) \\ &= \frac{22}{3} \text{ sq units} \end{aligned}$$

Note: If the question had been stated simply as:

“Find the area enclosed by the curves $g(x) = x + 2$ and $f(x) = x^2 + x - 2$.”

This would indicate that we want the total area enclosed by the two curves, as shown:

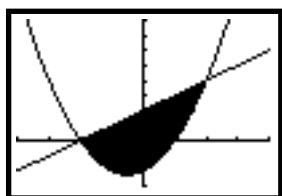

To find such an area we need first find the points of intersection:

$$\begin{aligned} x + 2 &= x^2 + x - 2 \Leftrightarrow x^2 - 4 = 0 \\ \therefore x &= \pm 2 \end{aligned}$$

$$\therefore \text{required area} = \int_{-2}^2 (4 - x^2)dx = \left[4x - \frac{x^3}{3} \right]_{-2}^2 = \frac{32}{3} \text{ sq units.}$$

EXAMPLE 22.27

 Find the area of the region enclosed by the curves $y = 4 - x$ and

$$y = \frac{2}{x-1}.$$

**S
o
l
u
t
i
o
n**

Again we first sketch both graphs so that we can see which one lies above the other:

Next, we find the points of intersection:

$$4 - x = \frac{2}{x-1} \Leftrightarrow (4-x)(x-1) = 2$$

$$\Leftrightarrow (x-3)(x-2) = 0$$

 Therefore, $x = 3$ or $x = 2$.

$$\text{Required area} = \int_2^3 \left((4-x) - \frac{2}{x-1} \right) dx$$

$$= \left[4x - \frac{x^2}{2} - 2\log_e(x-1) \right]_2^3$$

$$= \frac{3}{2} - 2\log_e 2 \text{ sq units}$$

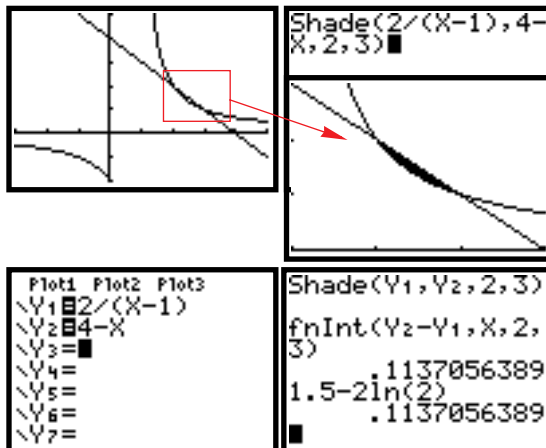
EXAMPLE 22.28

Find the exact value of the area of the region enclosed by the curves

 $y = \sin 2x$ and $y = \cos^2 x$ over the region $0 \leq x \leq \pi$.

**S
o
l
u
t
i
o
n**

 We start by sketching the graphs of $y = \sin 2x$ and $y = \cos^2 x$. Then determine the points of intersection.

$$\sin 2x = \cos^2 x \Leftrightarrow 2 \sin x \cos x = \cos^2 x$$

$$\Leftrightarrow \cos x (2 \sin x - \cos x) = 0$$

$$\Leftrightarrow \cos x = 0 \text{ or } \tan x = \frac{1}{2}$$

$$\text{i.e., } x = \frac{\pi}{2} \text{ or } x = \arctan\left(\frac{1}{2}\right)$$

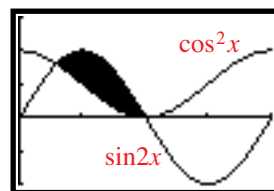
 Therefore, area of shaded region, A sq units, is given by

$$A = \int_{\arctan(\frac{1}{2})}^{\frac{\pi}{2}} [\sin 2x - \cos^2 x] dx = \int_{\arctan(\frac{1}{2})}^{\frac{\pi}{2}} \left[\sin 2x - \frac{1}{2}(\cos 2x + 1) \right] dx$$

$$= \left[-\frac{1}{2} \cos 2x - \frac{1}{4} \sin 2x - \frac{x}{2} \right]_{\arctan(\frac{1}{2})}^{\frac{\pi}{2}}$$

 We will need to evaluate $\cos 2x$ and $\sin 2x$ when $x = \arctan\left(\frac{1}{2}\right)$.

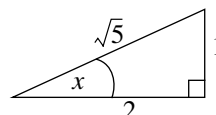
 We will need to construct a right-angled triangle for the given value of x :

MATHEMATICS – Higher Level (Core)

We first consider $\cos 2x$: Using the identity $\cos 2x = 2\cos^2 x - 1$ and the right-angled triangle

$$\text{we have that } \cos x = \frac{2}{\sqrt{5}} \therefore \cos 2x = 2\left(\frac{2}{\sqrt{5}}\right)^2 - 1 = \frac{8}{5} - 1 = \frac{3}{5}.$$

Next we consider $\sin 2x$: Using the identity $\sin 2x = 2\sin x \cos x$

$$\text{we have that } \sin x = \frac{1}{\sqrt{5}} \therefore \sin 2x = 2\left(\frac{1}{\sqrt{5}}\right)\left(\frac{2}{\sqrt{5}}\right) = \frac{4}{5}$$

$$\therefore A = \left[-\frac{1}{2} \cdot \cos \pi - \frac{1}{4} \cdot \sin \pi - \frac{\pi}{4} \right] - \left[-\frac{1}{2} \left(\frac{3}{5} \right) - \frac{1}{4} \left(\frac{4}{5} \right) - \frac{1}{2} \left(\arctan \left(\frac{1}{2} \right) \right) \right] \quad \text{Checking with TI-83:}$$

$$= \left[\frac{1}{2} - \frac{\pi}{4} \right] - \left[-\frac{3}{10} - \frac{1}{5} - \frac{1}{2} \arctan \left(\frac{1}{2} \right) \right]$$

$$= 1 + \frac{1}{2} \arctan \left(\frac{1}{2} \right) - \frac{\pi}{4}$$

i.e., area of shaded region is $1 + \frac{1}{2} \arctan \left(\frac{1}{2} \right) - \frac{\pi}{4}$ sq. units



EXERCISES 22.5

- Find the area of the region bounded by
 - $y = x^3$, the x -axis, and the line $x = 2$.
 - $y = 4 - x^2$, and the x -axis.
 - $y = x^3 - 4x$, the x -axis, and the lines $x = -2$ and $x = 0$.
 - $y = x^3 - 4x$, the x -axis, the line $x = 2$ and the line $x = 4$.
 - $y = \sqrt{x} - x$, the x -axis, and the lines $x = 0$ and $x = 1$.
- Find the area of the region bounded by
 - $f(x) = e^x + 1$, the x -axis, and the lines $x = 0$ and $x = 1$.
 - $f(x) = e^{2x} - 1$, the x -axis, the line $x = 1$ and the line $x = 2$.
 - $f(x) = e^x - e^{-x}$, the x -axis, the line $x = -1$ and the line $x = 1$.
 - $y = e^{\frac{1}{2}x+1} - x$, the x -axis, the line $x = 0$ and the line $x = 2$.
- Find the area of the region bounded by
 - $y = \frac{1}{x}$, the x -axis, the line $x = 4$ and the line $x = 5$.
 - $y = \frac{2}{x+1}$, the x -axis, the line $x = 0$ and the line $x = 4$.
 - $f(x) = \frac{3}{2-x}$, the x -axis, the line $x = -1$ and the line $x = 1$.
 - $f(x) = \frac{1}{x-1} + 1$, the x -axis, the line $x = -1$ and the line $x = \frac{1}{2}$.

- 4.** Find the area of the region bounded by
- $f(x) = 2 \sin x$, the x -axis, the line $x = 0$ and the line $x = \frac{\pi}{2}$.
 - $y = \cos(2x) + 1$, the x -axis, the line $x = 0$ and the line $x = \frac{\pi}{2}$.
 - $y = x - \cos\left(\frac{x}{2}\right)$, the x -axis, the line $x = \frac{\pi}{2}$ and the line $x = \pi$.
 - $f(x) = \cos(2x) - \sin\left(\frac{x}{2}\right)$, the x -axis, the line $x = \frac{\pi}{2}$ and the line $x = \pi$.
 - $y = 3 \sec^2\left(\frac{x}{2}\right)$, the x -axis, the line $x = -\frac{\pi}{3}$ and the line $x = \frac{\pi}{3}$.
- 5.** Verify your answers to Questions 1–4, using a graphics calculator.
- 6.** Find the area of the region enclosed by the curve $y = 8 - x^3$, the y -axis and the x -axis.
- 7.** Find the area of the region enclosed by the curve $y = x^2 + 1$, and the lines $y = 2$ and $y = 4$.
- 8.** Find the area of the region enclosed by the curve $f(x) = x + \frac{1}{x}$, the x -axis and the lines $x = -2$ and $x = -1$.
- 9.** Find the area of the region enclosed by the curve $y = x^2 - 1$, the x -axis, the line $x = 0$ and $x = 2$.
- 10.** Find the area of the region enclosed by the curve $y = x(x + 1)(x - 2)$ and the x -axis.
- 11.** Find the area of the region enclosed by the curve $f(x) = 1 - \frac{1}{x^2}$
- the x -axis, the line $x = 1$ and $x = 2$
 - the x -axis, the line $x = \frac{1}{2}$ and $x = 2$
 - and the lines $y = -\frac{1}{2}$ and $y = \frac{1}{2}$.
- 12.** The area of the region enclosed by the curve $y^2 = 4ax$ and the line $x = a$ is ka^2 sq units. Find the value of k .
- 13.** Differentiate the function $y = \log_e(\cos 2x)$. Hence find the area of the region enclosed by the curve $f(x) = \tan(2x)$, the x -axis and the lines $x = 0$ and $x = \frac{\pi}{8}$.
- 14.**
- Find the area of the region enclosed by the curve $y = |2x - 1|$ the x -axis, the line $x = -1$ and the line $x = 2$.
 - Find the area of the region enclosed by the curve $y = |2x| - 1$ the x -axis, the line $x = -1$ and the line $x = 2$.

MATHEMATICS – Higher Level (Core)

- 15.** Find the area of the region enclosed by the curve $f(x) = \frac{2}{(x-1)^2}$
- the x -axis, the lines $x = 2$ and $x = 3$,
 - the y -axis, the lines $y = 2$ and $y = 8$.
- 16.** (a) Differentiate the function $y = x \log_e x$, hence find $\int \log_e x dx$.
- (b) Find the area of the region enclosed by the curve $y = e^x$, the y -axis and the lines $y = 1$ and $y = e$.
- 17.** Find the area of the region bounded by the graphs of $y = x^2 + 2$ and $y = x$, over the interval $0 \leq x \leq 2$.
- 18.** (a) Find the area of the region bounded by the graphs of $y = 2 - x^2$ and $y = x$, over the interval $0 \leq x \leq 1$.
- (b) Find the area of the region bounded by the graphs of $y = 2 - x^2$ and $y = x$.
- 19.** (a) Find the area of the regions bounded by the following:
- $y = x^3$, $x = 1$, $x = 2$ and $y = 0$.
 - $y = x^3$, $y = 1$, $y = 8$ and $x = 0$.
- (b) How could you deduce part ii. from part i.?
- 20.** Find the area of the region bounded by the curves with equations $y = \sqrt{x}$, $y = 6 - x$ and the x -axis.
- 21.** (a) Sketch the graph of the function $f(x) = |e^x - 1|$.
- (b) Find the area of the region enclosed by the curve $y = f(x)$,
- the x -axis and the lines $x = -1$ and $x = 1$.
 - the y -axis and the line $y = e - 1$.
 - and the line $y = 1$. Discuss your findings for this case.
- 22.** (a) On the same set of axes, sketch the graphs of $f(x) = \sin\left(\frac{1}{2}x\right)$ and $g(x) = \sin 2x$ over the interval $0 \leq x \leq \pi$.
- (b) Find the area of the region between by the curves $y = f(x)$ and $y = g(x)$ over the interval $0 \leq x \leq \pi$, giving your answer correct to 2 decimal places.

- 23.** Consider the curve with equation $y^2 = x^3$ as shown in the diagram.
A tangent meets the curve at the point $A(a^2, a^3)$.

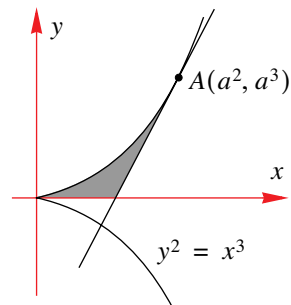

- Find the equation of the tangent at A.
- Find the area of the shaded region enclosed by the curve, the line $y = 0$ and the tangent.

- 24.** (a) On a set of axes, sketch the graph of the curve $y = e^{x-1}$ and find the area of the region enclosed by the curve, the x -axis and the lines $x = 0$ and $x = 1$.
- (b) Hence evaluate $\int_{e^{-1}}^1 (\ln x + 1) dx$.
- (c) Find the area of the region enclosed by the curves $y = e^{x-1}$ and $y = \ln x + 1$ over the $e^{-1} \leq x \leq 1$.

- 25.** The area of the shaded region enclosed by the y -axis, the tangent to the curve at $x = a$ and the curve $y^2 = x, y \geq 0$, as shown in the diagram below, measures $\frac{16}{3}$ sq. units.

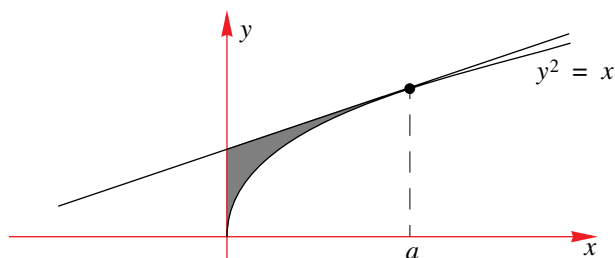

Find the exact value of a .

22.6 APPLICATIONS TO KINEMATICS

Another application of integration when relating it to areas is that of kinematics. Just as the gradient of the displacement–time graph produces the velocity–time graph, so too then, we have that the **area beneath the velocity–time graph** produces the **displacement–time** graph. Notice that the area provides the displacement (not necessarily the distance!).

Similarly with the acceleration–time graph, i.e., the **area under the acceleration–time graph** represents the **velocity**.

The displacement over the interval $[t_1, t_2]$ is given by

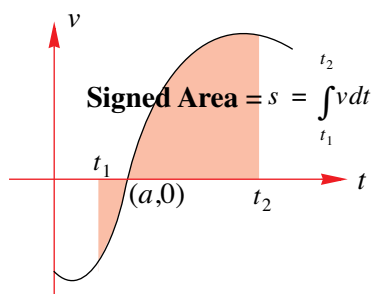

$$\text{Displacement} = s = \int_{t_1}^{t_2} v dt$$

However, the distance covered over the interval $[t_1, t_2]$ is given by

$$\text{Distance} = x = -\int_{t_1}^a v dt + \int_a^{t_2} v dt$$

EXAMPLE 22.29

The velocity of an object is v m/s after t seconds, where $v = 1 - 2 \sin 2t$.

- Find the object's displacement over the first $\frac{3\pi}{4}$ seconds.
- Find the distance travelled by the object over the first $\frac{3\pi}{4}$ seconds.

S
o
l
u
t
i
o
n

- It is always a good idea to sketch the velocity–time graph: The displacement is then given by

$$\begin{aligned} s &= \int_0^{\frac{3\pi}{4}} (1 - 2 \sin 2t) dt = \left[t + \cos 2t \right]_0^{\frac{3\pi}{4}} \\ &= \left(\frac{3\pi}{4} + \cos\left(\frac{6\pi}{4}\right) \right) - (0 + \cos(0)) \\ &= \frac{3\pi}{4} - 1 \\ &\approx 1.36 \end{aligned}$$

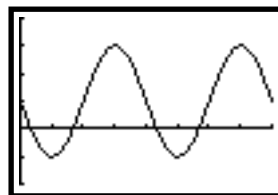

That is, the object's displacement measures (approx.) 1.36 metres.

Once we have sketched the velocity–time graph using the TI–83 we can make use of the $\int f(x) dx$ option under the **CALC** menu.

When prompted for the Lower and Upper Limits, enter the required x -values.

However, it must be understood that the $\int f(x) dx$ option provides the value of the signed area. In this case it provides the displacement not the distance (although sometimes these are the same). We now display this result:

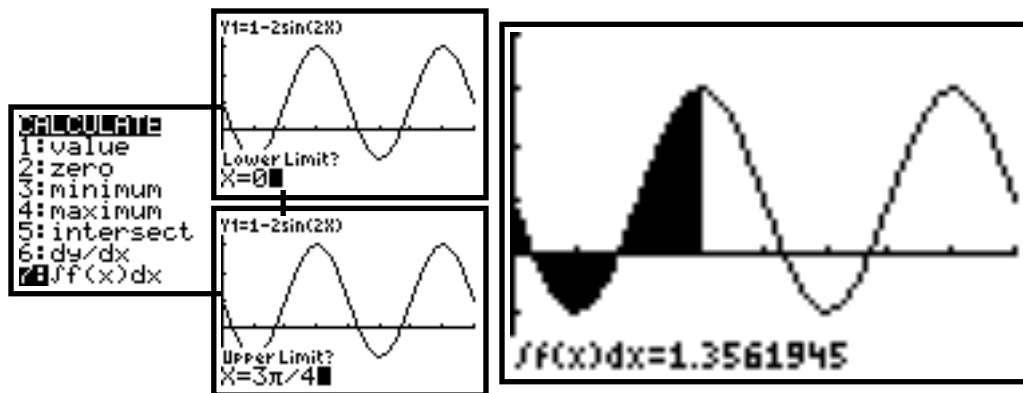

- (b) As part of the graph lies below the t -axis, when determining the distance travelled we use the same principle as that which differentiates between the signed area and the actual area enclosed by a curve and the horizontal axis. In short:

$$\begin{array}{l} \text{Displacement} = \text{Signed area} \\ \text{Distance} = \text{Area.} \end{array}$$

The first step is to determine the t -intercepts:

$$\text{Solving for } 1 - 2 \sin 2t = 0 \text{ we have, } \sin 2t = \frac{1}{2} \Rightarrow 2t = \frac{\pi}{6}, \frac{5\pi}{6}, \dots \therefore t = \frac{\pi}{12}, \frac{5\pi}{12}, \dots$$

Note that we only require the first two intercepts.

Therefore, the distance is given by

$$x = \int_0^{\frac{\pi}{12}} (1 - 2 \sin 2t) dt - \int_{\frac{\pi}{12}}^{\frac{5\pi}{12}} (1 - 2 \sin 2t) dt + \int_{\frac{5\pi}{12}}^{\frac{3\pi}{4}} (1 - 2 \sin 2t) dt$$

Evaluating this expression is rather lengthy, and—unless we require an exact value— we might as well make use of the graphics calculator.

There are a number of ways this can be done. Either we can make repeated use of the previous method i.e., using the $\int f(x) dx$ option in the **CALC** menu for each interval, or we could use the **9: fnInt**(option in the **MATH** menu.

$$\begin{aligned} \text{Distance travelled} \\ = 0.1278 - (-0.6849) + 1.9132 = 2.7259. \end{aligned}$$

That is, object travelled (approx.) 2.73 m.

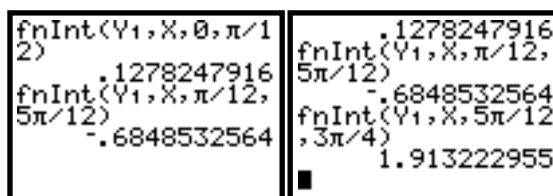

EXAMPLE 22.30

A rocket starts from rest and accelerates such that its acceleration is given by the formula $a(t) = 3t + t^2$, $0 \leq t \leq 10$ where distances are measured in metres and time in seconds. Find the distance travelled in the first ten seconds of the rocket's motion.

The information is given as an acceleration. We must find the indefinite integral of this function to get a rule to give us the velocity.

$$a(t) = 3t + t^2, 0 \leq t \leq 10 \Rightarrow v(t) = \int(3t + t^2)dt = \frac{3t^2}{2} + \frac{t^3}{3} + c$$

$$\text{Now, when } t = 0, v = 0 : 0 = 0 + 0 + c \Rightarrow c = 0$$

The constant is zero because we are told that the rocket starts from rest. The distance travelled is the area under this velocity time graph. Which must be found using definite integration. As the graph of $v(t)$ lies above the t -axis over the interval $0 \leq t \leq 10$, we have the distance D , given by

$$\begin{aligned} D &= \int_0^{10} \left(\frac{3t^2}{2} + \frac{t^3}{3} \right) dt = \left[\frac{t^3}{2} + \frac{t^4}{12} \right]_0^{10} \\ &= \frac{10^3}{2} + \frac{10^4}{12} \\ &= 1333\frac{1}{3} \text{ m} \end{aligned}$$

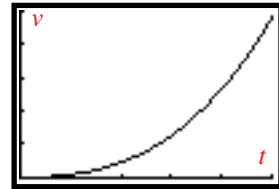

The technique described in this example is the basis of the inertial navigator. This senses acceleration and integrates it to infer velocity. The instrument then integrates a second time to calculate distance travelled. Of course, none of these quantities are generally expressed as exact mathematical formulae and the calculation has to be performed using numerical approximation.

EXERCISES 22.6

1. Find the displacement equation, $x(t)$, for each of the following

(a) $\frac{d^2x}{dt^2} = 6t$ where $\frac{dx}{dt} = 3$ and $x = 10$ when $t = 0$.

(b) $\frac{d^2x}{dt^2} = -(4\sin t + 3\cos t)$ where $\frac{dx}{dt} = 4$ and $x = 2$ when $t = 0$.

(c) $\frac{d^2x}{dt^2} = 2 - e^{-\frac{1}{2}t}$ where $\frac{dx}{dt} = 4$ and $x = 0$ when $t = 0$.

2. The acceleration, $a(t)$ ms^{-2} , of a body travelling in a straight line and having a displacement $x(t)$ m from an origin is governed by

$$a(t) = 6t - 2 \text{ where } \frac{dx}{dt} = 0 \text{ and } x = 0 \text{ when } t = 0.$$

- (a) Find the displacement of the body at any time t .
- (b) Find the displacement of the body after 5 seconds.
- (c) Find the distance the body has travelled after 5 seconds.

3. A body moves along a straight line in such a way that its velocity, v ms^{-1} , is given by

$$v(t) = -\sqrt{t+4} + 2.$$

After 5 seconds of motion the body is at the origin O.

- (a) Sketch the displacement-time graph for this body.
- (b) How far will the body have travelled after another 5 seconds.

- 4.** A particle starts from rest and moves with a velocity, $v \text{ ms}^{-1}$, where $v = t(t - 5)$. Find the distance travelled between the two occasions when the particle is at rest.
- 5.** A stone is thrown vertically upwards from ground level with a velocity of 25 ms^{-1} . If the acceleration of the stone is 9.8 ms^{-2} directed downwards, find the time taken before the stone reaches its highest point and the total distance travelled when the stone falls back to the ground.
- 6.** The velocity of a particle is given by $v(t) = 3 - 3 \sin 3t$, which is measured in m/s.
- Find when the particle first comes to rest.
 - Find the distance travelled by the particle from when it started to when it first comes to rest.
- 7.** An object, starting from rest, moves in a straight line with an acceleration that is given by $a(t) = \frac{12}{(t+1)^2} \text{ ms}^{-2}$. Find the distance travelled during the first 9 seconds.
- 8.** An object has its velocity governed by the equation $v(t) = 10 \sin\left(\frac{\pi}{16}t\right) \text{ m/s}$.
- Given that $s(0) = 0$, find its displacement equation.
 - Find its displacement after 20 seconds.
 - Find its displacement during the 20th second.
 - How far has it travelled in twenty seconds?
- 9.** A particle moving in a straight line has its acceleration, $a \text{ ms}^{-2}$, defined by the equation
- $$a = \frac{2k}{t^3} \text{ ms}^{-2}.$$
- At the end of the first second of motion, the particle has a velocity measuring 4 m/s .
- Find an expression for the velocity of the particle.
 - Given that its velocity approaches a limiting value of 6 m/s , find k .
 - Find the distance travelled by the particle after a further 9 seconds.
- 10.** (a) Show that $\frac{d}{dx} \left[\frac{e^{ax}}{a^2 + b^2} (a \cos bx + b \sin bx) \right] = e^{ax} \cos bx$.
- (b) The velocity of a vibrating bridge component is modelled by the function $V = e^{-2t} \cos(3t)$. $V \text{ ms}^{-1}$ is the velocity of the component and t is the time in seconds after the observations begin. Find the distance the component travels in the first tenth of a second.

22.7 APPLICATIONS TO PROBABILITY

22.7.1 CONTINUOUS RANDOM VARIABLES

The idea of a continuous variable was introduced in Chapter 17 when we met the idea that probability can be measured by finding the area under a curve – the normal curve. In this section, we will look at examples in which these areas are found by integration.

A **continuous probability density function** (or continuous probability distribution), $f(x)$, is a function satisfying the following properties:

1. The variable is continuous and can assume all real-valued numbers.
2. The function is non-negative, i.e., $f(x) \geq 0$.
3. The total area contained between the graph and the horizontal axis is 1.

$$\text{i.e., } \int_{-\infty}^{\infty} f(x) dx = 1$$

Often we have that the probability density function is defined over some interval, $a \leq x \leq b$, so that $f(x) \geq 0$ for $a \leq x \leq b$ and $f(x) = 0$ elsewhere. This means that $\int_{-\infty}^{\infty} f(x) dx = 1$ is rewritten as

$$\begin{aligned} \int_{-\infty}^{\infty} f(x) dx &= \int_{-\infty}^a f(x) dx + \int_a^b f(x) dx + \int_b^{\infty} f(x) dx = \int_{-\infty}^a 0 dx + \int_a^b f(x) dx + \int_b^{\infty} 0 dx \\ &= \int_a^b f(x) dx \end{aligned}$$

So that rather than using $\int_{-\infty}^{\infty} f(x) dx = 1$ we use $\int_a^b f(x) dx = 1$

EXAMPLE 22.31

Find the value of k such that the function: $f(x) = \begin{cases} k(2x - x^2) & 0 \leq x \leq 2 \\ 0 & \text{otherwise} \end{cases}$

is a probability density function.

S
o
l
u
t
i
o
n

It is generally a good idea to look at these problems graphically. In the present case, the graph is shown. There is a restricted domain. Outside the domain $0 \leq x \leq 2$, the graph runs along the x -axis.

If the function is to be a continuous probability density function, then the shaded area must be 1.

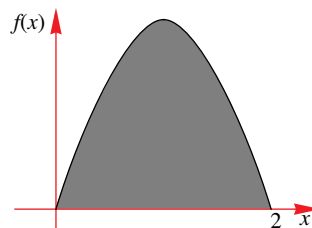

So, we have $\int_0^2 k(2x - x^2) dx = 1 \Leftrightarrow k \left[\frac{2x^2}{2} - \frac{x^3}{3} \right]_0^2 = 1$

$$\therefore k \left(4 - \frac{8}{3} \right) = 1 \Leftrightarrow k = \frac{3}{4}$$

Determining probabilities

When dealing with a discrete random variable X , we have seen, in Chapter 16, that the probability that X lies in the interval $a \leq X \leq b$ is evaluated by using $p(a \leq X \leq b) = \sum_{x=a}^{x=b} p(x)$. We have a similar expression for finding probabilities that involve a continuous random variable X :

Let the continuous random variable X have a pdf (probability density function), $f(x)$ defined over the interval $a \leq x \leq b$. Then, to find the probability that X lies in the interval $x_1 \leq X \leq x_2$, where $a \leq x_1 \leq X \leq x_2 \leq b$ we find the area of the region enclosed by the curve $y = f(x)$, the x -axis and the lines $x = x_1$ and $x = x_2$. That is,

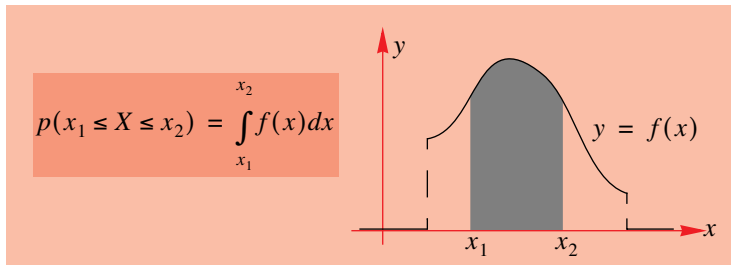

EXAMPLE 22.32

The continuous random variable X has a probability density function

$$\text{defined by } f(x) = \begin{cases} k(2-x)^2 & 0 \leq x \leq 2 \\ 0 & \text{elsewhere} \end{cases}.$$

- (a) Find k .
 (b) Find the probability that i. $0.5 < X \leq 1$ ii. $X > 1/X > 0.5$

S
o
l
u
t
i
o
n

(a) As $f(x)$ is a pdf, then $\int_0^2 f(x) dx = 1 \Rightarrow \int_0^2 k(2-x)^2 dx = 1$

$$\Leftrightarrow k \left[-\frac{1}{3}(2-x)^3 \right]_0^2 = 1$$

$$\Leftrightarrow k \left[0 + \frac{8}{3} \right] = 1$$

$$\Leftrightarrow k = \frac{3}{8}$$

(b) i. $p(0.5 < X \leq 1) = \int_{0.5}^1 \frac{3}{8}(2-x)^2 dx$
 $= \left[-\frac{1}{8}(2-x)^3 \right]_{0.5}^1$
 $= \frac{19}{64}$

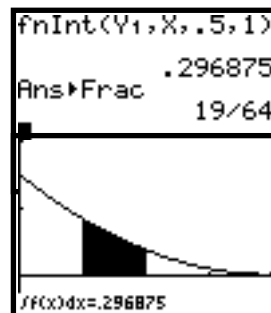

$$\text{ii. } p(X > 1 | X > 0.5) = \frac{p(\{X > 1\} \cap \{X > 0.5\})}{p(X > 0.5)} = \frac{P(X > 1)}{p(X > 0.5)}$$

$$\text{Now, } P(X > 1) = \int_1^2 \frac{3}{8}(2-x)^2 dx = \left[-\frac{1}{8}(2-x)^3 \right]_1^2 = \left[0 + \frac{1}{8} \right] = \frac{1}{8}$$

$$\text{and } p(X > 0.5) = \int_{0.5}^2 \frac{3}{8}(2-x)^2 dx = \left[-\frac{1}{8}(2-x)^3 \right]_{0.5}^2 = \left[0 + \frac{27}{64} \right] = \frac{27}{64}.$$

$$\text{Therefore, } p(X > 1 | X > 0.5) = \frac{(1/8)}{(27/64)} = \frac{8}{27}$$

Note that the use of the graphics calculator to evaluate these integrals is very useful for this type of calculation.

EXAMPLE 22.33

The time (t minutes) that Lennie finds that he has to wait in the supermarket

queue before being served is modelled by the function: $f(t) = \begin{cases} 0.03(5 + 4t - t^2) & 0 \leq t \leq 5 \\ 0 & \text{otherwise} \end{cases}$

- (a) Sketch the graph of the probability density function.
- (b) Find the probability that Lennie will have to wait between 1 and 3 minutes for service.

S
o
l
i
t
i
o
n

- (a) The graph is an inverted parabola. Note again that the domain is defined as the interval $[0,5]$ and that the function is zero elsewhere.
- (b) The required probability is a definite integral. As with other continuous variables, the probability that Lennie will have to wait *exactly* 3 minutes is zero. It only makes sense to calculate the probability that he will have to wait between two times or less than a given time or more than a given time.

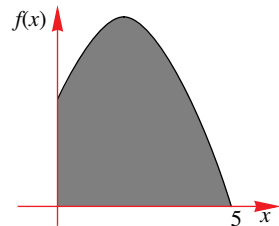

$$\begin{aligned} p(1 \leq T \leq 3) &= \int_1^3 0.03(5 + 4t - t^2) dt \\ &= 0.03 \left[5t + 2t^2 - \frac{t^3}{3} \right]_1^3 \\ &= 0.03 \left(\left(5 \times 3 + 2 \times 3^2 - \frac{3^3}{3} \right) - \left(5 \times 1 + 2 \times 1^2 - \frac{1^3}{3} \right) \right) \\ &= 0.03 \left(15 + 18 - 9 - 5 - 2 + \frac{1}{3} \right) \\ &= 0.52 \end{aligned}$$

If X is a continuous random variable then $p(X = a) = 0$. This then means that including or excluding the end points of an interval makes no difference to evaluating the integral.

That is, $p(a \leq X \leq b) = p(a < X \leq b) = p(a < X < b) = p(a \leq X < b)$.

EXERCISES 22.7.1

- 1.** Find the value of k such that $f(x) = \begin{cases} kx^2 & 0 \leq x \leq 3 \\ 0 & \text{otherwise} \end{cases}$ is a probability density function.

Find also $p(0 \leq X \leq 1)$.

- 2.** Prove that $f(x) = \begin{cases} 1 & 0 \leq x \leq 1 \\ 0 & \text{otherwise} \end{cases}$ is a probability density function. Find $p(0 \leq x \leq 0.1)$.

- 3.** Find the value of k such that $f(x) = \begin{cases} \frac{x}{k} & 0 \leq x \leq 4 \\ 0 & \text{otherwise} \end{cases}$ is a probability density function.

Find also $p(2 \leq x \leq 3)$.

- 4.** Prove that $f(x) = \begin{cases} \frac{\sin x}{2} & 0 \leq x \leq \pi \\ 0 & \text{otherwise} \end{cases}$ is a probability density function.

Find also $p(0.5 \leq x \leq 0.7)$ correct to 3 significant figures.

- 5.** The time (t minutes) between the arrivals of successive buses at a city bus stop is modelled

$$\text{by the function } f(t) = \begin{cases} \frac{e^{-t/2}}{2} & t > 0 \\ 0 & \text{otherwise} \end{cases}$$

- Prove that f represents a probability density function.
- Find the probability that, if I have just missed a bus, I will have to wait more than ten minutes for the next one.

- 6.** The function $f(x) = \begin{cases} \frac{k}{x+1} & 0 \leq x \leq 2 \\ 0 & \text{otherwise} \end{cases}$ represents the distribution of the amount by

which a machine tends to overfill 100 kilogram bags of cement, where x measures the number of kilograms that a bag has been overfilled.

- Find the value of k such that f represents a probability density function.
- Find the probability that a randomly chosen bag contains more than 101kg.

- 7.** The time (t minutes) spent by travellers waiting for an urban transit train at a particular

$$\text{station is modelled by the function } f(x) = \begin{cases} 2e^{-2t} & t > 0 \\ 0 & \text{otherwise} \end{cases}.$$

MATHEMATICS – Higher Level (Core)

- i. Prove that f represents a probability density function.
- ii. Find the probability that a randomly chosen passenger will have to wait more than 1 minute.
- iii. Find the percentage of passengers that will have to wait more than 2 minutes.
- iv. It is estimated that passengers who have to wait more than 4 minutes at the station will complain to the staff. If the station handles 10000 passengers per day, how many complaints could the staff expect to receive per day?

- 8.** The errors in timing races at the athletics meeting are represented by the function

$$f(t) = \begin{cases} k(1-t^2) & -1 < t < 1 \\ 0 & \text{otherwise} \end{cases} \text{ where } t \text{ is the error in making the measurement with}$$

positive t sec representing measured times that were longer than those actually taken and negative values representing measured times that were less than the time actually taken.

- i. Find the value of k such that f represents a probability density function.
- ii. Find the probability that the error in time measurement of a given race was between 0.1 and 0.5 seconds.
- iii. Find the proportion of the races in which the absolute error in the measurement of the time was less than one tenth of a second.
- iv. The 100 metres sprint was timed at 13.7 seconds. What is the probability that the time actually taken for the race was more than 13.6 seconds?

- 9.** Prove that the function $f(x) = \begin{cases} ke^{-kx} & x > 0 \\ 0 & \text{otherwise} \end{cases}$ represents a continuous distribution for all values of k where $k > 0$.

- 10.** Find the exact value of a such that the function $f(x) = \begin{cases} x^3 & 0 < x < a \\ 0 & \text{otherwise} \end{cases}$ represents a continuous distribution.

22.7.2 MODE, MEAN, MEDIAN AND VARIANCE

The main measures of central tendency and spread can be calculated for continuous random variables in the same way as for discrete random variables - Chapter 16. We provide a summary of these definitions, noting the analogies between the expressions used for continuous random variables and discrete counterparts.

Mode

The **mode**, m_d , of a distribution is the value of the variable where the probability density is largest. Graphically, the mode is that value of x which provides the maximum value of the probability density function.

The mode may be found using calculus if the maximum point is not obvious from the graph. That is, solving the equation

$$f'(m_d) = 0.$$

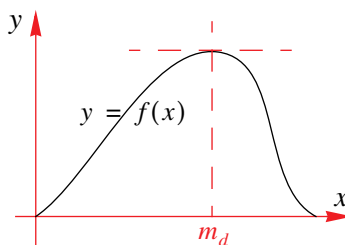

Mean (Expected value)

The **mean**, $\mu = E(X)$, is defined in a way similar to that used in statistics where we calculate $\sum x \times f$, the sum of the product of the data values and their frequencies. For a probability function (equivalent to frequency), this becomes $E(X) = \int_{-\infty}^{\infty} x \times f(x) dx$. In practice, the terminals of the integral will be the end-points of the domain of the function.

Median

The **median**, m , is the value of the variable such that half the probability is below that value and half above.

As probability is interpreted as area, this means that we are looking for a value of the variable that has half the area to the left of the value.

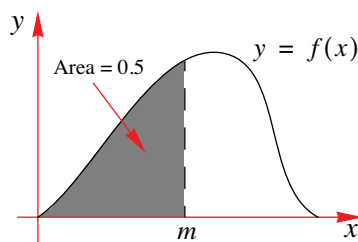

That is, we want the value(s) m such that $\int_{-\infty}^m f(x) dx = \frac{1}{2}$

Variance

The **variance**, $Var(X) = \sigma^2$, is calculated using a formula similar to the statistical formula $\sigma^2 = E(X^2) - [E(X)]^2$. For a probability function, the variance is given by:

$$\sigma^2 = \int_{-\infty}^{\infty} x^2 \times f(x) dx - \mu^2.$$

The **standard deviation**, σ , of the distribution is the square root of the variance:

$$\sigma = \sqrt{\sigma^2} = \sqrt{\int_{-\infty}^{\infty} x^2 \times f(x) dx - \mu^2}$$

EXAMPLE 22.34

Find the mode, mean, median, variance and standard deviation of the

$$\text{probability function } f(x) = \begin{cases} \frac{6x^2 - 3x^3}{4} & 0 \leq x \leq 2 \\ 0 & \text{otherwise} \end{cases}$$

The **mode** is that value of the random variable that produces the maximum point on the probability function. In this case, we will need to use calculus to find this:

$$f(x) = \frac{6x^2 - 3x^3}{4} \Rightarrow f'(x) = 3x - \frac{9}{4}x^2. \text{ Then, } f'(x) = 0 \Leftrightarrow 3x - \frac{9}{4}x^2 = 0$$

$$\therefore 3x \left(1 - \frac{3}{4}x\right) = 0$$

$$\Leftrightarrow x = 0, \frac{4}{3}$$

A graph will establish which of these values provides that maximum value of $f(x)$:

MATHEMATICS – Higher Level (Core)

From the graph, it can be seen that the maximum value of the function occurs when $x = \frac{4}{3}$. We can conclude that the mode is $m_d = \frac{4}{3}$.

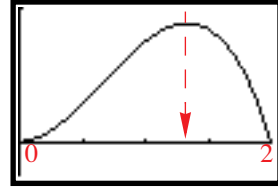

The **mean** is calculated using the formula: $\int_{-\infty}^{\infty} x \times f(x) dx$

$$\begin{aligned} \therefore E(X) &= \int_0^2 \left(x \times \frac{6x^2 - 3x^3}{4} \right) dx = \int_0^2 \left(\frac{3}{2}x^3 - \frac{3}{4}x^4 \right) dx \\ &= \left[\frac{3}{8}x^4 - \frac{3}{20}x^5 \right]_0^2 \\ &= \frac{3}{8} \times 2^4 - \frac{3}{20} \times 2^5 - 0 \\ &= 1.2 \end{aligned}$$

This result is a bit less than the mode. Non-symmetric distributions such as this do not necessarily have the same values for mode, mean and median.

Let m be the **median** of $f(x)$, then, the median satisfies the equation $\int_{-\infty}^m f(x) dx = \frac{1}{2}$. All that is now required, is to solve for m :

$$\int_{-\infty}^m f(x) dx = \frac{1}{2} \Leftrightarrow \int_0^m \frac{6x^2 - 3x^3}{4} dx = \frac{1}{2} \text{ or } \int_0^m 6x^2 - 3x^3 dx = 2 \text{ [multiplying b.s. by 4]}$$

$$\text{Now, } \int_0^m 6x^2 - 3x^3 dx = \left[2x^3 - \frac{3}{4}x^4 \right]_0^m = 2m^3 - \frac{3}{4}m^4.$$

$$\text{Therefore, we need to solve } 2m^3 - \frac{3}{4}m^4 = 2.$$

$$\text{So, } 2m^3 - \frac{3}{4}m^4 = 2 \Leftrightarrow 3m^4 - 8m^3 + 8 = 0$$

However, this cannot be solved directly and so we make use of the graphics calculator. Using the **solve**(option, we have:
Therefore, the median is $m = 1.2285$ (to 4 d.p).

```
solve(3x^4-8x^3+
8,x,{0,2})
1.228544864
```

Finally, to calculate the **variance** (and the standard deviation) of the function, we must evaluate: $\sigma^2 = \int_{-\infty}^{\infty} x^2 \times f(x) dx - \mu^2$

$$\begin{aligned} \sigma^2 &= \int_0^2 x^2 \times \frac{6x^2 - 3x^3}{4} dx - \mu^2 = \int_0^2 \frac{6x^4 - 3x^5}{4} dx - 1.2^2 \\ &= \left[\frac{3x^5}{10} - \frac{x^6}{8} \right]_0^2 - 1.2^2 \\ &= 1.6 - 1.2^2 \end{aligned}$$

Therefore, the variance, $\text{Var}(X) = 0.16$.

The **standard deviation** is $\sigma = \sqrt{0.16} = 0.4$

EXAMPLE 22.35

A continuous random variable X has a probability density function defined

$$\text{by } f(x) = \begin{cases} ax^k & \text{for } x \in [0, 2] \\ 0 & \text{elsewhere} \end{cases}, \text{ where } a \text{ and } k \text{ are positive real constants. Find, in terms of } k,$$

the expected value and the median of X .

S
o
l
u
t
i
o
n

$$\text{As } f(x) \text{ is a pdf, then } \int_0^2 ax^k dx = 1 \Leftrightarrow a \left[\frac{1}{k+1} x^{k+1} \right]_0^2 = 1$$

$$\therefore a \left[\frac{2^{k+1}}{k+1} - 0 \right] = 1$$

$$a = \frac{k+1}{2^{k+1}}$$

$$\begin{aligned} \text{Now, } E(X) &= \int_0^2 xf(x) dx = \int_0^2 ax^{k+1} dx = a \left[\frac{1}{k+2} x^{k+2} \right]_0^2 \\ &= a \left[\frac{2^{k+2}}{k+2} - 0 \right] \\ &= \frac{k+1}{2^{k+1}} \times \frac{2^{k+2}}{k+2} \\ &= 2 \left(\frac{k+1}{k+2} \right) \end{aligned}$$

Next, the median, m , is found by solving $\int_0^m f(x) dx = \frac{1}{2}$.

$$\begin{aligned} \text{So, we have } \int_0^m ax^k dx &= a \left[\frac{1}{k+1} x^{k+1} \right]_0^m = a \left[\frac{1}{k+1} m^{k+1} - 0 \right] = \frac{k+1}{2^{k+1}} \times \frac{1}{k+1} m^{k+1} \\ &= \left(\frac{m}{2} \right)^{k+1} \end{aligned}$$

$$\text{Then, as } \left(\frac{m}{2} \right)^{k+1} = \frac{1}{2} \Rightarrow \frac{m}{2} = \sqrt[k+1]{\frac{1}{2}} \therefore m = 2 \times \sqrt[k+1]{\frac{1}{2}} = 2 \times 2^{-\frac{1}{k+1}} = 2^{\frac{k}{k+1}}.$$

That is, the median, $m = 2^{\frac{k}{k+1}}$

EXERCISES 22.7.2

1. For the probability function: $f(x) = \begin{cases} 1 & 0 \leq x \leq 1 \\ 0 & \text{otherwise} \end{cases}$, find:

- The mean and median.
- The variance and standard deviation.

MATHEMATICS – Higher Level (Core)

2. For the probability function: $f(x) = \begin{cases} 3x^2 & 0 \leq x \leq 1 \\ 0 & \text{otherwise} \end{cases}$, find:

- i. The mode, mean and median.
- ii. The variance and standard deviation.

3. The weights, w grams, of a species of mollusc are distributed according to the function:

$$f(x) = \begin{cases} \frac{3(-24 + 10x - x^2)}{4} & 4 \leq x \leq 6 \\ 0 & \text{otherwise} \end{cases} .$$

- i. Calculate the mode, mean and median weights.
- ii. Find the standard deviation of the weights.
- iii. Assuming that approximately 95% of the weights will lie within 2 standard deviations of the mean, find this 95% confidence interval for the weights of this species of mollusc.

4. The time, t sec, taken to test an electronic circuit is a variable distributed according to the

function $f(t) = \begin{cases} \frac{t}{2} & 0 \leq t \leq 2 \\ 0 & \text{otherwise} \end{cases} .$

- i. Calculate the mode, mean and median times.
- ii. Find the standard deviation of the times.
- iii. If one of the measures of central tendency was to be used to estimate the amount of time that it would take to test ten thousand of these circuits, which measure would give the best estimate.

5. The time intervals, t seconds, between the arrivals of customers at a large supermarket is a

continuous random variable modelled by the function $f(t) = \begin{cases} 0.2e^{-0.2t} & t \geq 0 \\ 0 & \text{otherwise} \end{cases}$

- i. Find the modal time between arrivals.
- ii. Find the median time between customer arrivals.
- iii. Find the mean time between arrivals. Use an approximate method of integration.
- iv. Find the standard deviation of the times between arrivals, using an approximate method of integration.
- v. Using an approximate 95% confidence interval, what is the longest time between arrivals of customers that is likely to occur?

6. Find the mode, mean and median of the probability distribution

$$f(x) = \begin{cases} \frac{(1 - \cos x)}{2\pi} & 0 \leq x \leq 2\pi \\ 0 & \text{otherwise} \end{cases}$$

- 7.** Find the mean and variance of the lengths (cm) of the tails of a species of bird if these lengths are distributed according to the probability function:

$$f(x) = \begin{cases} \frac{6(-66 + 17x - x^2)}{125} & 6 \leq x \leq 11 \\ 0 & \text{otherwise} \end{cases}$$

- 8.** The life span of a species of reptiles has been found to have a probability distribution

$$\text{given by } f(t) = \begin{cases} \frac{1}{80}e^{-t/80} & \text{for } t \geq 0 \\ 0 & \text{elsewhere} \end{cases}.$$

- (a) Find the 25th percentile of the life distribution for this species of reptile.
 (b) Find an expression for $F(t) = p(T \leq t)$, for $t \geq 0$. $F(t)$ is known as the cumulative distribution of the random variable T .
 (c) Sketch the graph of $F(t)$.

- 9.** The random variable X has a probability density function given by

$$f(x) = \begin{cases} ax(b-x) & \text{for } x \in [0, 2] \\ 0 & \text{elsewhere} \end{cases}$$

where a and b are positive constants.

- (a) Show that
 i. $b \geq 2$.
 ii. $a = \frac{3}{6b-8}$.
 (b) If $E(X) = \frac{8}{7}$, find a and b .
 (c) Find the mode of X .

- 10.** The time, t days, until recovery after a certain medical procedure is a continuous random

$$\text{variable having a probability density function } f(t) = \begin{cases} \frac{k}{\sqrt{t-2}} & \text{for } 3 \leq t \leq 7 \\ 0 & \text{elsewhere} \end{cases}.$$

- (a) Find k .
 (b) Find the probability that it will take a patient at least 5 days to recover.
 (c) What is the median recovery time for patients undergoing this procedure?
 (d) Find the expected recovery time, giving your answer to two decimal places.

- 11.** (a) Differentiate the function $h(x) = x(1-x)^{3/2}$.
 (b) The random variable X has a probability density function

$$f(x) = \begin{cases} a\sqrt{1-x} & \text{for } x \in [0, 1] \\ 0 & \text{elsewhere} \end{cases}$$

where a is a positive real constant.

- i. Find the value of a .
 ii. Find the median and mode of X .
 iii. Find the exact value of the mean of X .

22.8 VOLUMES (SOLID OF REVOLUTION)

A **solid of revolution** is formed by revolving a plane region about a line – called the **axis of revolution**. In this section we will only be using the x -axis or the y -axis.

For example, in the diagram alongside, if we revolve the triangular plane region about the vertical axis as shown, we obtain a cone.

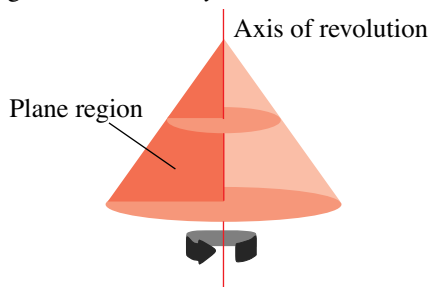

It is important to realise that depending on the axis of revolution, we can obtain very different shapes. For example, if a region bounded by the curve $y = x^2, x \geq 0$ is rotated about the x - and y -axes, two distinct solid shapes are formed:

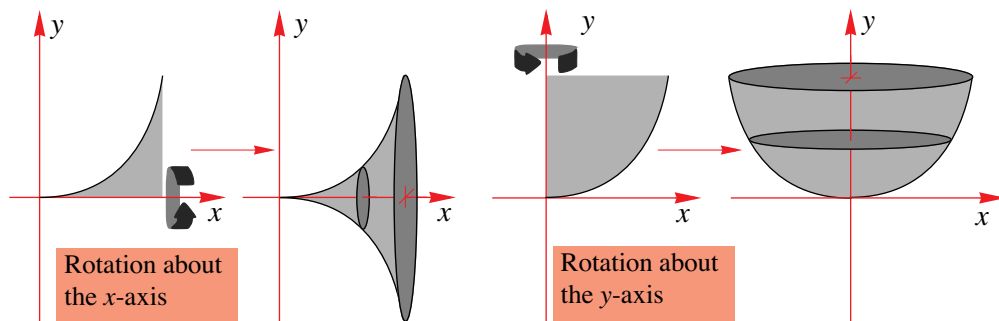

When the plane region (enclosed by the curve and the x -axis) is rotated about the x -axis, the solid object produced is rather like the bell of a trumpet (with a very narrow mouth piece!) or a Malay hat on its side. However, when the plane region (enclosed by the curve and the y -axis) is rotated about the y -axis, then the solid produced is like a bowl.

Using the same approach as that used when finding the area of a region enclosed by a curve, the x -axis and the lines $x = a$ and $x = b$ we have:

Then, the volume, V units³, of such a solid can be cut up into a large number of slices (i.e., discs) each having a width δx and radius $f(x_i)$. The volume produced is then the sum of the volumes of these discs, i.e.,

$$V \approx \sum_{i=0}^{i=n-1} \pi [f(x_i)]^2 \delta x, \text{ where } \delta x = \frac{b-a}{n}$$

So, as $n \rightarrow \infty, \delta x \rightarrow 0$ and so,

$$V = \lim_{\delta x \rightarrow 0} \sum_{i=0}^{i=n-1} \pi [f(x_i)]^2 \delta x = \int_a^b \pi [f(x)]^2 dx$$

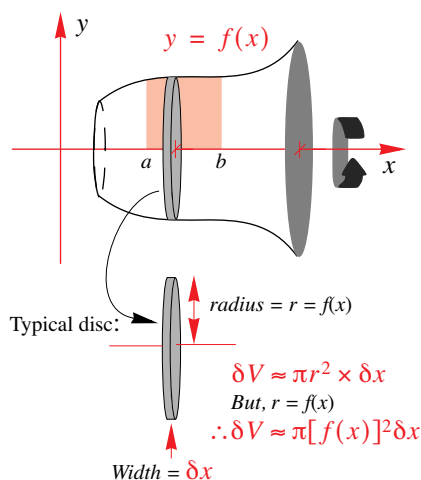

Therefore, we have:

The volume, V units³, of a solid of revolution is given by

$$V = \pi \int_{x=a}^{x=b} [f(x)]^2 dx \quad \left[\text{or } V = \pi \int_a^b y^2 dx \right]$$

when a plane region enclosed by the curve, $y = f(x)$ and the lines $x = a$ and $x = b$ is revolved about the x -axis.

$$V = \pi \int_{y=e}^{y=f} [f^{-1}(y)]^2 dy \quad \left[\text{or } V = \pi \int_e^f x^2 dy \right]$$

when a plane region enclosed by the curve, $y = f(x)$ and the lines $y = e$ and $y = f$ is revolved about the y -axis.

EXAMPLE 22.36

The curve $y = \sqrt{x-1}$, $1 \leq x \leq 5$ is rotated about the x -axis to form a solid of revolution. Sketch this solid and find its volume.

If the same curve is rotated about the y -axis, a different solid is formed. Sketch this second solid and find its volume.

S
o
l
u
t
i
o
n

The curve has a restricted domain and is rotated about the x -axis, so, the solid formed has a volume given by

$$\begin{aligned} V &= \pi \int_1^5 (\sqrt{x-1})^2 dx = \pi \int_1^5 (x-1) dx \\ &= \pi \left[\frac{x^2}{2} - x \right]_1^5 \\ &= \pi \left(\frac{5^2}{2} - 5 - \left(\frac{1^2}{2} - 1 \right) \right) \\ &= 8\pi \end{aligned}$$

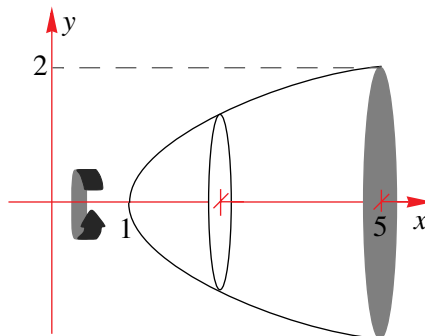

Therefore, the volume generated is 8π units³.

If the curve is rotated about the y -axis, the solid formed looks like this:

The volume can now be found using the second formula.

It is important to realise that the integral limits are in terms of the y variable and so are 0 and 2.

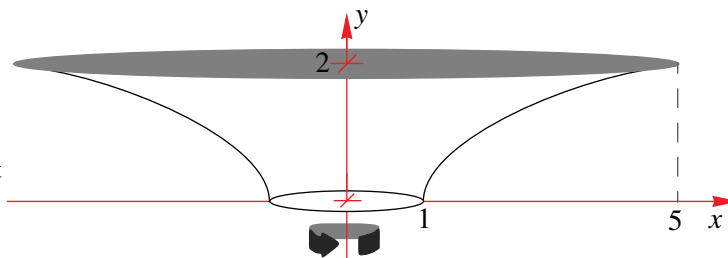

Also, x must be made the subject of the rule for the curve:

$$y = \sqrt{x-1} \Rightarrow y^2 = x-1 \Rightarrow x = y^2 + 1$$

When $x = 1$, $y = 0$ and when $x = 5$, $y = 2$, entering these values into the formula gives:

$$\begin{aligned} V &= \pi \int_0^2 (y^2 + 1)^2 dy = \pi \int_0^2 (y^4 + 2y^2 + 1) dy = \pi \left[\frac{y^5}{5} + \frac{2y^3}{3} + y \right]_0^2 \\ &= \pi \left(\frac{2^5}{5} + \frac{2(2^3)}{3} + 2 \right) \\ &= 13 \frac{11}{15} \pi \end{aligned}$$

i.e., required volume is $13 \frac{11}{15} \pi$ units³

EXAMPLE 22.37

Find the volume of a circular cone whose semi-vertical angle is α and has a height h cm.

- S** A circular cone of height h can be generated by revolving the region enclosed by an oblique straight line about the y -axis from $y = 0$ to $y = h$:
I Our first task is to find the equation of the straight line.
u From the diagram, the straight line has equation
t $y = mx$
i To find m we note that $m = \tan \theta$ where θ is the angle that the line makes with the positive x -axis, therefore we
n have that $\theta = \frac{\pi}{2} - \alpha$ and so, $m = \tan\left(\frac{\pi}{2} - \alpha\right) = \cot \alpha$.

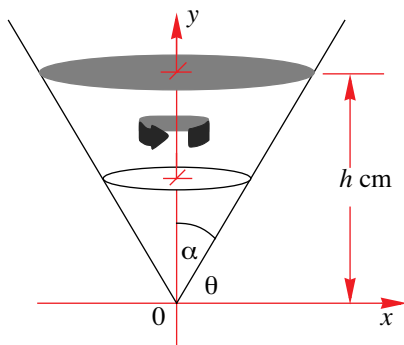

Therefore, the equation of the straight line is

$$y = (\cot \alpha)x$$

Next, as we are revolving the plane about the y -axis, we

use the expression
$$V = \pi \int_a^b x^2 dy$$

with $a = 0$, $b = h$ and from $y = (\cot \alpha)x$ we have, $x = \frac{y}{\cot \alpha}$ or $x = (\tan \alpha)y$.

That is,
$$\begin{aligned} V &= \pi \int_0^h [(\tan \alpha)y]^2 dy = \pi \tan^2 \alpha \int_0^h y^2 dy \\ &= \pi \tan^2 \alpha \left[\frac{1}{3} y^3 \right]_0^h \\ &= \pi \tan^2 \alpha \left[\frac{1}{3} h^3 - 0 \right] \\ &= \frac{1}{3} (\pi \tan^2 \alpha) h^3 \end{aligned}$$

i.e., the volume is $\frac{1}{3} (\pi \tan^2 \alpha) h^3$ cm³.

EXAMPLE 22.38

Find the volume of the solid formed by revolving the region enclosed by the curve with equation $f(x) = \sqrt{25 - x^2}$ and the line $g(x) = 3$ about the x -axis.

**S
o
l
u
t
i
o
n**

We start by drawing a diagram of this situation:

It is a bead.

Next we determine the points of intersection.

Setting $f(x) = g(x)$ we have

$$\sqrt{25 - x^2} = 3$$

$$\therefore 25 - x^2 = 9$$

$$\Leftrightarrow x^2 = 16$$

$$\therefore x = \pm 4$$

The solid formed is hollow inside, i.e., from $-3 \leq y \leq 3$.

Next, we find the difference between the two volumes generated (a little bit like finding the area between two curves)

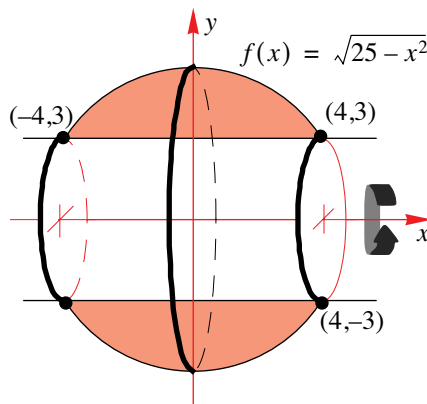

$$\begin{aligned} V &= V_{f(x)} - V_{g(x)} = \pi \int_{-4}^4 [f(x)]^2 dx - \pi \int_{-4}^4 [g(x)]^2 dx \\ &= \pi \int_{-4}^4 ([f(x)]^2 - [g(x)]^2) dx \\ &= 2\pi \int_0^4 ([f(x)]^2 - [g(x)]^2) dx \quad \text{[by symmetry]} \end{aligned}$$

Therefore,

$$\begin{aligned} V &= 2\pi \int_0^4 ([\sqrt{25 - x^2}]^2 - [3]^2) dx \\ &= 2\pi \int_0^4 (16 - x^2) dx \\ &= 2\pi \left[16x - \frac{1}{3}x^3 \right]_0^4 \\ &= \frac{256}{3}\pi \end{aligned}$$

i.e., required volume is $\frac{256}{3}\pi$ units³.

Finding volumes of revolution is an application of definite integration. Your only restriction will be the limitations on your ability to find integrals.

In the following exercise, you will need to draw on all the techniques you have learned in the preceding sections.

EXERCISES 22.8

* Unless stated otherwise, all answers should be given as an exact value.

1. The part of the line $y = x + 1$ between $x = 0$ and $x = 3$ is rotated about the x -axis. Find the volume of this solid of revolution.
2. A curve is defined by $y = \frac{1}{\sqrt{x}}$, $x \in [1, 5]$. If this curve is rotated about the x -axis, find the volume of the solid of revolution formed.
3. The curve $y = \frac{1}{x}$ between the x values $\frac{1}{5}$ and 1 is rotated about the y -axis. Find the volume of the solid of revolution formed in this way.
4. Find the volume of the solid of revolution formed by rotating the part of the curve $y = e^x$ between $x = 1$ and $x = 5$ about the x -axis.
5. A solid is formed by rotating the curve $y = \sin x$, $x \in [0, 2\pi]$ about the x -axis. Find the volume of this solid.
6. The part of the curve $y = \frac{1}{1-x}$ between the x values 2 and 3 is rotated about the x -axis. Find the volume of this solid.
7. The part of the line $y = \frac{x-1}{2}$ between $x = 5$ and $x = 7$ is rotated about the y -axis. Find the volume of the solid of revolution formed in this way.
8. The part of the curve $y = \frac{x}{1+x}$ between the x values 0 and 2 is rotated about the x -axis. Find the volume of the solid formed in this way.
9. Find the equation of the straight line that passes through the origin and through the point (h, r) . Hence use calculus to prove that the volume of a right circular cone with base radius r and height h is given by $V = \frac{1}{3}\pi r^2 h$.
10. Find the equation of a circle of radius r . Use calculus to prove that the volume of a sphere is given by the formula $V = \frac{4}{3}\pi r^3$.

11. The diagram shows a shape known as a frustum. Use calculus to prove that its volume is given by the formula

$$V = \frac{h}{3}(B_1 + B_2 + \sqrt{B_1 B_2})$$

where B_1 and B_2 are the areas of the circular top and base respectively

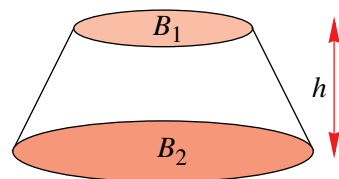

- 12.** The part of the curve $f(x) = \sin \frac{x}{10}$ between $x = 0$ and $x = 5$ is rotated about the x -axis. Find the volume of this solid of revolution.
- 13.** The part of the curve $f(x) = x^2 - x + 2$ between $x = 1$ and $x = 2$ is rotated about the x -axis. Find the volume of this solid of revolution.
- 14.** (a) Find the volume generated by the region between by the y -axis and that part of the parabola $y = x^2$ from $x = 1$ to $x = 3$ when it is rotated about the y -axis.
 (b) Find the volume generated by the region between by the x -axis and that part of the parabola $y = x^2$ from $x = 1$ to $x = 3$ when it is rotated about the x -axis.
- 15.** Find the volume of the solid of revolution that is formed by rotating the region bounded by the curves $y = \sqrt{x}$ and $y = \sqrt{x^3}$ about
 (a) the y -axis (b) the x -axis.
- 16.** Find the volume of the solid of revolution that is formed when the region bounded by the curve with equation $y = 4 - x^2$ and the line $y = 1$ is rotated about
 (a) the y -axis (b) the x -axis.
- 17.** Find the volume of the solid generated by rotating the region bounded by the curves $y^2 = x^3$ and $y^2 = 2 - x$ about the x -axis.
- 18.** The volume of the solid formed when the region bounded by the curve $y = e^x - k$, the x -axis and the line $x = \ln 3$ is rotated about the x -axis is $\pi \ln 3$ units³. Find k .
- 19.** Find the volume of the solid of revolution formed by rotating the region bounded by the axes and the curve $y = \sqrt{3}a \sin x + a \cos x$, $0 \leq x \leq 2\pi$, $a > 0$ about the x -axis.
- 20.** If the curve of the function $f(\theta) = \sin k\theta$, $k > 0$, $\theta > 0$ is rotated about the θ -axis, a string of sausages is made. Find k such that the volume of each sausage is π units³.
- 21.** (a) On the same set of axes, sketch the curves $y = ax^2$ and $y = 1 - \frac{x^2}{a}$ where $a > 0$.
 (b) Find the volume of the solid of revolution formed when the region enclosed by the curves in (a) is i. rotated about the y -axis ii. rotated about the x -axis.
- 22.** (a) On the same set of axes sketch the two sets of points $\{(x, y) : (x - 2)^2 + y^2 \leq 4\}$ and $\{(x, y) : (x - a)^2 + y^2 \leq 4, a \in]-2, 6[\}$. The intersection of these two sets is rotated about the x -axis to generate a solid. Find a if the volume of this solid is π units³. Give your answer to three decimal places.
 (b) A donut is formed by rotating the curve $\{(x, y) : (x - a)^2 + y^2 = 1, |a| > 1\}$ about the y -axis. Find a if the volume of the donut is 100π units³.

Extension Problems

- 23.** Find the volume of the solid of revolution generated when the shaded region shown below is revolved about the line $y = 2$.

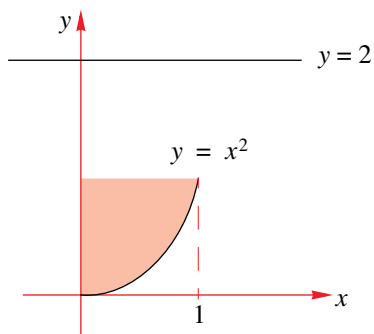

- 24.** Find the volume of the solid of revolution generated by revolving the region enclosed by the curve $y = 4 - x^2$ and $y = 0$ about
- the line $y = -3$.
 - the line $x = 3$.
 - the line $y = 7$.
- In each case, draw the shape of the solid of revolution.

- 25.** Using an argument similar to that found in Section 22.5 show why the **arc length**, L units, of a curve from $x = a$ to $x = b$ is given by $L = \int_a^b \sqrt{1 + [f'(x)]^2} dx$.

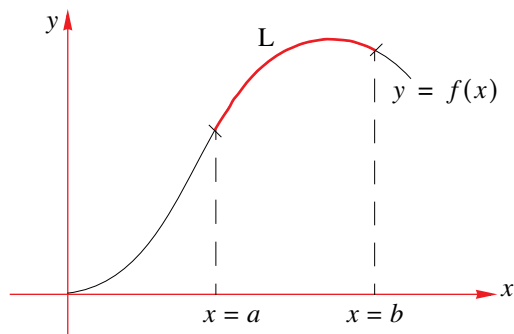

23.1 INTEGRATION BY SUBSTITUTION

23.1.1 INDEFINITE INTEGRALS

In Chapter 22 we saw how to obtain the antiderivative, $F(x) + c$, of a function $f(x)$ based on the results that $\frac{d}{dx}(F(x)) = f(x)$. That is,

$$\text{If } \frac{d}{dx}(F(x)) = f(x) \text{ then } \int f(x)dx = F(x) + c$$

For example, if we know that $\frac{d}{dx}(\sin 5x) = 5 \cos 5x$, then, $\int 5 \cos 5x dx = \sin 5x + c$.

Similarly, if $\frac{d}{dx}(\ln(x^2 + 1)) = \frac{2x}{x^2 + 1}$, then, $\int \frac{2x}{x^2 + 1} dx = \ln(x^2 + 1) + c$.

Basically, we are using **recognition** to obtain antiderivatives. Such a skill is crucial to become successful at finding more complex antiderivatives.

One particularly important result is based on the chain rule, from which we obtained the generalised ‘power rule’ for differentiation; $\frac{d}{dx}([f(x)]^n) = nf'(x)[f(x)]^{n-1}$.

From this result we have $\int \frac{d}{dx}([f(x)]^n) dx = \int nf'(x)[f(x)]^{n-1} dx$

so that $\int nf'(x)[f(x)]^{n-1} dx = [f(x)]^n + c$

This leads to the result

$$\int g'(x)[g(x)]^n dx = \frac{1}{n+1}[g(x)]^{n+1} + c$$

The use of this result is dependent on an ability to recognise the expressions $g(x)$ and its derivative $g'(x)$ within the integrand. We consider a number of examples.

EXAMPLE 23.1

Find the indefinite integral of the following

(a) $2x(x^2 + 9)^5$ (b) $(3x^2 + 1)(x^3 + x)^2$ (c) $-2x\sqrt{1-x^2}$

S
o
l
u
t
i
o
n

(a) We observe that $2x(x^2 + 9)^5$ can be written as $g'(x)[g(x)]^5$ with $g(x) = x^2 + 9$.

$$\begin{aligned} \text{Therefore, by recognition we have } \int 2x(x^2 + 9)^5 dx &= \frac{1}{5+1}(x^2 + 9)^{5+1} + c \\ &= \frac{1}{6}(x^2 + 9)^6 + c \end{aligned}$$

We observe that $\frac{1}{x+1}[\ln(x+1)]^{1/2}$ can be written as $g'(x)[g(x)]^{1/2}$ with $g(x) = \ln(x+1)$.

$$\begin{aligned} \text{By recognition we have } \int \frac{1}{x+1}[\ln(x+1)]^{1/2} dx &= \frac{1}{\frac{1}{2}+1} [\ln(x+1)]^{\frac{1}{2}+1} + c \\ &= \frac{2}{3} [\ln(x+1)]^{3/2} + c \\ &= \frac{2}{3} \sqrt{[\ln(x+1)]^3} + c \end{aligned}$$

What if the expression is not exactly in the form $\int g'(x)[g(x)]^n dx$, but only differs by some multiple. That is, what happens when we have $\int x(x^2+3)^4 dx$ or $\int 5x(x^2+3)^4 dx$ rather than $\int 2x(x^2+3)^4 dx$?

As the expressions only differ by a multiple, we manipulate them so that they transform into $\int g'(x)[g(x)]^n dx$. For example:

$$\int x(x^2+3)^4 dx = \frac{1}{2} \int 2x(x^2+3)^4 dx = \frac{1}{2} \times \frac{1}{5} (x^2+3)^5 + c = \frac{1}{10} (x^2+3)^5 + c$$

[i.e., multiply and divide by 2.]

$$\int 5x(x^2+3)^4 dx = 5 \int x(x^2+3)^4 dx = \frac{5}{2} \int 2x(x^2+3)^4 dx = \frac{5}{2} \times \frac{1}{5} (x^2+3)^5 + c$$

[i.e., 'take' 5 outside the integral sign, then multiply and divide by 2.]

$$= \frac{1}{2} (x^2+3)^5 + c$$

These manipulation skills are essential for successfully determining indefinite integrals by recognition.

We continue with some more examples.

EXAMPLE 23.3

Find the indefinite integral of the following

(a) $3 \cos 3x \sin^4 3x$ (b) $3 \sec^2 4x \tan^2 4x$ (c) $\sin \frac{1}{2} x \sqrt{1 + \cos \frac{1}{2} x}$

S
O
L
U
T
I
O
N

(a) We observe that $3 \cos 3x \sin^4 3x = 3 \cos 3x (\sin 3x)^4$ can be written as $g'(x)[g(x)]^4$ with $g(x) = \sin 3x$.

$$\begin{aligned} \text{Then, by recognition we have, } \int 3 \cos 3x (\sin 3x)^4 dx &= \frac{1}{4+1} (\sin 3x)^{4+1} + c \\ &= \frac{1}{5} (\sin 3x)^5 + c \end{aligned}$$

(b) Now, $3 \sec^2 4x \tan^2 4x = 3 \sec^2 4x (\tan 4x)^2$ which is **nearly** in the form $g'(x)[g(x)]^2$. So our first task is to 'convert' it into the required form.

With $g(x) = \tan 4x$ we have $g'(x) = 4 \sec^2 4x$, meaning that we only differ by a multiple.

MATHEMATICS – Higher Level (Core)

$$\int 3 \sec^2 4x (\tan 4x)^2 dx = 3 \int \sec^2 4x (\tan 4x)^2 dx = \frac{3}{4} \int 4 \sec^2 4x (\tan 4x)^2 dx$$

[i.e., ‘take’ 3 outside the integral sign, then multiply and divide by 4.]

$$= \frac{3}{4} \times \frac{1}{3} (\tan 4x)^3 + c$$

$$= \frac{1}{4} \tan^3 4x + c$$

(c) We observe that $\sin \frac{1}{2}x \sqrt{1 + \cos \frac{1}{2}x} = \sin \frac{1}{2}x \left(1 + \cos \frac{1}{2}x\right)^{1/2}$ which is **nearly** in the form $g'(x)[g(x)]^{1/2}$. So our first task is to ‘convert’ it into the required form.

With $g(x) = 1 + \cos \frac{1}{2}x$ we have that $g'(x) = -\frac{1}{2} \sin \frac{1}{2}x$, meaning that we only differ by a multiple.

$$\begin{aligned} \int \sin \frac{1}{2}x \left(1 + \cos \frac{1}{2}x\right)^{1/2} dx &= -2 \int \left(-\frac{1}{2} \sin \frac{1}{2}x \left(1 + \cos \frac{1}{2}x\right)^{1/2}\right) dx \quad \text{[multiply \& divide by -2]} \\ &= -2 \cdot \frac{2}{3} \left(1 + \cos \frac{1}{2}x\right)^{3/2} + c \\ &= -\frac{4}{3} \sqrt{\left(1 + \cos \frac{1}{2}x\right)^3} + c \end{aligned}$$

There is another group of expressions that belong to the ‘recognition’ group of integrands. These are based on the results of Chapter 19 when we obtained the generalised derivatives.

Derivatives	Antiderivatives
$\frac{d}{dx}[e^{f(x)}] = f'(x)e^{f(x)}$	$\int f'(x)e^{f(x)} dx = e^{f(x)} + c$
$\frac{d}{dx}[\ln f(x)] = \frac{f'(x)}{f(x)}$	$\int \frac{f'(x)}{f(x)} dx = \ln f(x) + c$
$\frac{d}{dx}[\sin f(x)] = f'(x)\cos f(x)$	$\int f'(x)\cos f(x) dx = \sin f(x) + c$
$\frac{d}{dx}[\cos f(x)] = -f'(x)\sin(f(x))$	$\int f'(x)\sin(f(x)) dx = -\cos f(x) + c$
$\frac{d}{dx}[\tan f(x)] = f'(x)\sec^2(f(x))$	$\int f'(x)\sec^2(f(x)) dx = \tan f(x) + c$

EXAMPLE 23.4

Find the indefinite integral of the following

(a) $3 \cos 2x e^{\sin 2x}$

(b) $2x^2 \sin(x^3)$

(c) $\frac{4x}{5 + 3x^2}$

Solution

$$(a) \quad \int 3 \cos 2x e^{\sin 2x} dx = 3 \int \cos 2x e^{\sin 2x} dx = \frac{3}{2} \int 2 \cos 2x e^{\sin 2x} dx \\ = \frac{3}{2} e^{\sin 2x} + c$$

$$(b) \quad \int 2x^2 \sin(x^3) dx = 2 \int x^2 \sin(x^3) dx = \left(-\frac{2}{3}\right) \int -3x^2 \sin(x^3) dx \\ = -\frac{2}{3} \cos(x^3) + c$$

$$(c) \quad \int \frac{4x}{5+3x^2} dx = 4 \int \frac{x}{5+3x^2} dx = \frac{4}{6} \int \frac{6x}{5+3x^2} dx \\ = \frac{2}{3} \ln(5+3x^2) + c$$

Finding the definite integral of expressions such as those we have just encountered is carried out in the same way as in Chapter 22.

EXAMPLE 23.5

Evaluate the following

$$(a) \quad \int_0^1 2x\sqrt{1+x^2} dx \quad (b) \quad \int_0^{\frac{\pi}{2}} \frac{\cos x}{1+2\sin x} dx \quad (c) \quad \int_e^{4e} \frac{1}{x} (\ln x)^3 dx$$

Solution

$$(a) \quad \int_0^1 2x\sqrt{1+x^2} dx = \int_0^1 2x(1+x^2)^{1/2} dx = \left[\frac{1}{\frac{1}{2}+1} (1+x^2)^{\frac{1}{2}+1} \right]_0^1 \quad [\text{using } \int g'(x)[g(x)]^n dx] \\ = \left[\frac{2}{3} (1+x^2)^{3/2} \right]_0^1 \\ = \frac{2}{3} \left[\sqrt{(1+x^2)^3} \right]_0^1 \\ = \frac{2}{3} [\sqrt{2^3} - \sqrt{1^3}] \\ = \frac{2}{3} (2\sqrt{2} - 1)$$

$$(b) \quad \int_0^{\frac{\pi}{2}} \frac{\cos x}{1+2\sin x} dx = \frac{1}{2} \int_0^{\frac{\pi}{2}} \frac{2\cos x}{1+2\sin x} dx = \frac{1}{2} \left[\ln(1+2\sin x) \right]_0^{\frac{\pi}{2}} \quad [\text{Of the form } \int \frac{f'(x)}{f(x)} dx] \\ = \frac{1}{2} \left[\ln\left(1+2\sin\frac{\pi}{2}\right) - \ln(1+2\sin 0) \right]$$

$$\text{i.e., } \int_0^{\frac{\pi}{2}} \frac{\cos x}{1+2\sin x} dx = \frac{1}{2} [\ln 3 - \ln 1] = \frac{1}{2} \ln 3$$

$$(c) \quad \int_e^{4e} \frac{1}{x} (\ln x)^3 dx = \left[\frac{1}{4} (\ln x)^4 \right]_e^{4e} = \frac{1}{4} [(\ln 4e)^4 - (\ln e)^4] \quad [\text{Of the form } \int g'(x)[g(x)]^n dx]$$

MATHEMATICS – Higher Level (Core)

We conclude this section by considering another set of indefinite integrals that rely on recognition – the inverse circular trigonometric functions. Based on the results of their derivatives we have:

Derivatives	Antiderivatives
$\frac{d}{dx}\left[\text{Sin}^{-1}\left(\frac{x}{a}\right)\right] = \frac{1}{\sqrt{a^2 - x^2}}$	$\int \frac{1}{\sqrt{a^2 - x^2}} dx = \text{Sin}^{-1}\left(\frac{x}{a}\right) + c$
$\frac{d}{dx}\left[\text{Cos}^{-1}\left(\frac{x}{a}\right)\right] = -\frac{1}{\sqrt{a^2 - x^2}}$	$\int \frac{-1}{\sqrt{a^2 - x^2}} dx = \text{Cos}^{-1}\left(\frac{x}{a}\right) + c$
$\frac{d}{dx}\left[\text{Tan}^{-1}\left(\frac{x}{a}\right)\right] = \frac{a}{a^2 + x^2}$	$\int \frac{a}{a^2 + x^2} dx = \text{Tan}^{-1}\left(\frac{x}{a}\right) + c$

EXAMPLE 23.6

Determine

(a) $\int \frac{3}{\sqrt{16 - x^2}} dx$ (b) $\int_1^2 \frac{2}{3 + x^2} dx$ (c) $\int -\frac{5}{\sqrt{9 - 4x^2}} dx$

**S
o
l
u
t
i
o
n**

(a) $\int \frac{3}{\sqrt{16 - x^2}} dx = 3 \int \frac{1}{\sqrt{16 - x^2}} dx = 3 \int \frac{1}{\sqrt{4^2 - x^2}} dx = 3 \text{Sin}^{-1}\left(\frac{x}{4}\right) + c.$

(b) $\int_1^2 \frac{2}{3 + x^2} dx = 2 \int_1^2 \frac{1}{(\sqrt{3})^2 + x^2} dx = \frac{2}{\sqrt{3}} \int_1^2 \frac{\sqrt{3}}{(\sqrt{3})^2 + x^2} dx = \frac{2}{\sqrt{3}} \left[\text{Tan}^{-1}\left(\frac{x}{\sqrt{3}}\right) \right]_1^2$
 $= \frac{2}{\sqrt{3}} \left[\text{Tan}^{-1}\left(\frac{2}{\sqrt{3}}\right) - \text{Tan}^{-1}\left(\frac{1}{\sqrt{3}}\right) \right]$
 $= \frac{2}{\sqrt{3}} \left[\text{Tan}^{-1}\left(\frac{2}{\sqrt{3}}\right) - \frac{\pi}{6} \right]$

(c) $\int -\frac{5}{\sqrt{9 - 4x^2}} dx = 5 \int \frac{-1}{\sqrt{9 - 4x^2}} dx = 5 \int \frac{-1}{\sqrt{4\left(\frac{9}{4} - x^2\right)}} dx = \frac{5}{2} \int \frac{-1}{\sqrt{\left[\left(\frac{3}{2}\right)^2 - x^2\right]}} dx$
 $= \frac{5}{2} \text{Cos}^{-1}\left(\frac{x}{(3/2)}\right) + c$
 $= \frac{5}{2} \text{Cos}^{-1}\left(\frac{2x}{3}\right) + c$

EXERCISES 23.1.1

For this set of exercises, use the method of recognition to determine the integrals.

1. Find the following indefinite integrals.

(a) $\int 10x\sqrt{5x^2 + 2} dx$ (b) $\int \frac{x^2}{(x^3 + 4)^2} dx$ (c) $\int -6x(1 - 2x^2)^3 dx$

(d)	$\int 3\sqrt{x}(9 + 2\sqrt{x^3})^4 dx$	(e)	$\int 6 \cdot x^3\sqrt{x^2 + 4} dx$	(f)	$\int \frac{2x + 3}{(x^2 + 3x + 1)^3} dx$
(g)	$\int \frac{4x}{\sqrt{x^2 + 2}} dx$	(h)	$\int \frac{x^3}{(1 - x^4)^4} dx$	(i)	$\int 3e^{3x}\sqrt{1 + e^{3x}} dx$
(j)	$\int \frac{x + 1}{(x^2 + 2x - 1)^2} dx$	(k)	$\int \frac{x^2 + 1}{\sqrt{x^3 + 3x + 1}} dx$	(l)	$\int x\sqrt{3 + 4x^2} dx$
(m)	$\int \frac{e^x}{\sqrt{e^x + 2}} dx$	(n)	$\int \frac{e^{-2x}}{(1 - e^{-2x})^3} dx$	(o)	$\int 10x^2(x^3 + 1)^4 dx$
(p)	$\int (x^3 + 2)(x^4 + 8x - 3)^5 dx$	(q)	$\int 2x^3\sqrt{(x^4 + 5)^3} dx$	(r)	$\int \frac{\cos 2x}{\sqrt{1 - \sin 2x}} dx$
(s)	$\int \cos x \sqrt{4 + 3 \sin x} dx$	(t)	$\int \frac{\sec^2 4x}{(1 + 3 \tan 4x)^2} dx$	(u)	$\int \frac{1 - \sin x}{\sqrt[3]{x + \cos x}} dx$
(v)	$\int \sin \frac{1}{2} x \cos^3 \frac{1}{2} x dx$	(w)	$\int \frac{x \cos x + \sin x}{\sqrt{1 + x \sin x}} dx$	(x)	$\int \frac{(\sqrt{x} + 1)^{1/2}}{\sqrt{x}} dx$

2. Find the antiderivative of the following

(a)	$2xe^{x^2+1}$	(b)	$\frac{3}{\sqrt{x}}e^{\sqrt{x}}$	(c)	$\sec^2 3x e^{\tan 3x}$
(d)	$(2ax + b)e^{-(ax^2 + bx)}$	(e)	$3 \sin \frac{1}{2} x e^{\cos \frac{1}{2} x}$	(f)	$\frac{4}{x^2} e^{4+x^{-1}}$
(g)	$e^x \sin(2e^x)$	(h)	$\frac{e^{2x}}{(1 - e^{2x})^2}$	(i)	$\frac{e^{-x}}{1 + e^{-x}}$
(j)	$\frac{5}{e^{-x} + 2}$	(k)	$e^{-ax}\sqrt{4 + e^{-ax}}$	(l)	$\frac{e^{2x}}{1 + e^{2x}} \ln(1 + e^{2x})$

3. Find the antiderivative of the following

(a)	$2x \sin(x^2 + 1)$	(b)	$\frac{5}{\sqrt{x}} \sin(\sqrt{x})$	(c)	$\frac{2}{x^2} \cos\left(2 + \frac{1}{x}\right)$
(d)	$\sin x \sqrt{\cos x}$	(e)	$\frac{\sin 3x}{\cos 3x}$	(f)	$\frac{4 \sec^2 3x}{1 + \tan 3x}$
(g)	$\frac{4 \sec^2 3x}{(1 + \tan 3x)^2}$	(h)	$\frac{2}{x} \cos(\ln x)$	(i)	$\sin x \cos x \sqrt{1 + \cos 2x}$
(j)	$e^x \cos(e^x)$	(k)	$3x^2 e^{-x^3+2}$	(l)	$\cot \frac{1}{2} x \ln\left(\sin \frac{1}{2} x\right)$
(m)	$\sin x \sec^2 x$	(n)	$\frac{1}{e^{-x} + 2} \ln(1 + 2e^x)$	(o)	$(x^2 - 3) \sec^2\left(\frac{1}{3}x^3 - 3x\right)$

4. Find the antiderivative of the following

(a)	$\frac{2}{4 + x^2}$	(b)	$\frac{3}{x^2 + 9}$	(c)	$\frac{\sqrt{5}}{5 + x^2}$
(d)	$\frac{1}{\sqrt{25 - x^2}}$	(e)	$\frac{1}{\sqrt{16 - x^2}}$	(f)	$-\frac{1}{\sqrt{9 - x^2}}$

MATHEMATICS – Higher Level (Core)

5. Find the following indefinite integrals

(a) $\int \frac{3}{1+x^2} dx$	(b) $\int \frac{5}{\sqrt{1-x^2}} dx$	(c) $\int \frac{1}{\sqrt{4-x^2}} dx$
(d) $\int \frac{1}{\sqrt{9-x^2}} dx$	(e) $\int \frac{1}{\sqrt{1-4x^2}} dx$	(f) $\int \frac{1}{\sqrt{9-4x^2}} dx$
(g) $\int \frac{1}{\sqrt{4-25x^2}} dx$	(h) $\int \frac{2}{1+4x^2} dx$	(i) $\int \frac{1}{9+4x^2} dx$
(j) $\int \frac{1}{9+16x^2} dx$	(k) $\int \frac{1}{9+5x^2} dx$	(l) $\int \frac{1}{\sqrt{3-5x^2}} dx$

6. Evaluate

(a) $\int_1^4 x^{1/2}(1+x^{3/2})^5 dx$	(b) $\int_0^1 \frac{e^x}{\sqrt{1+e^x}} dx$	(c) $\int_0^{\frac{3\pi}{4}} \frac{3 \sin x}{1+\cos x} dx$
(d) $\int_0^{\pi} \frac{8}{4+x^2} dx$	(e) $\int_{-1}^1 e^x \cos(e^x) dx$	(f) $\int_0^{\frac{\pi}{2}} \sqrt{x} \sin x^{3/2} dx$
(g) $\int_0^{\frac{\pi}{4}} \sqrt{\tan x} \sec^2 x dx$	(h) $\int_{-1}^1 3x^2 e^{x^3} dx$	(i) $\int_e^{e^2} \frac{1}{x \ln x} dx$
(j) $\int_3^4 x \sqrt{x^2-9} dx$	(k) $\int_{-2}^2 \frac{x}{\sqrt{9-x^2}} dx$	(l) $\int_1^2 \frac{4x}{(1+x^2)^2} dx$
(m) $\int_0^1 \frac{1}{x^2+1} dx$	(n) $\int_{-1}^1 \frac{1}{4+x^2} dx$	(o) $\int_0^3 \frac{1}{1+9x^2} dx$
(p) $\int_0^{1/3} \frac{1}{\sqrt{1-4x^2}} dx$	(q) $\int_{\frac{1}{3}}^{\frac{1}{2}} \frac{1}{\sqrt{1-4x^2}} dx$	(r) $\int_0^{\frac{1}{2}} \frac{1}{9x^2+1} dx$
(s) $\int_{\frac{1}{8}}^{\frac{1}{2}} \frac{1}{4+9x^2} dx$	(t) $\int_0^{\frac{\pi}{6}} \sin^3 x \cos x dx$	(u) $\int_0^{\frac{\pi}{4}} \sec x \tan^3 x dx$
(v) $\int_1^e \frac{(\ln x)^2}{x} dx$	(w) $\int_0^1 \frac{2-x^2}{\sqrt{1-x^2}} dx$	(x) $\int_{\frac{\pi}{3}}^{\frac{\pi}{6}} \frac{\cos 3x}{(4+\sin 3x)^2} dx$

23.1.2 SUBSTITUTION RULE

In the previous section we considered integrals that required the integrand to be of a particular form in order to carry out the antidifferentiation process.

For example, the integral $\int 2x\sqrt{1+x^2}dx$ is of the form $\int h'(x)[h(x)]^n dx$ and so we could

proceed by using the result $\int h'(x)[h(x)]^n dx = \frac{1}{n+1}[h(x)]^{n+1} + c$.

Next consider the integral $\int x\sqrt{x-1} dx$. This is not in the form $\int h'(x)[h(x)]^n dx$ and so we cannot rely on the recognition approach we have used so far. To determine such an integral we need to use a formal approach.

Indefinite integrals that require the use of the general power rule can also be determined by making use of a method known as the **substitution rule** (or **change of variable** rule). The name of the rule is pretty much indicative of the process itself, basically, we introduce a new variable, u (say), and substitute it for an appropriate part (or the whole) of the integrand. An important feature of this method is that it will enable us to find the integral of expressions that cannot be determined by the use of the general power rule.

We illustrate this process using a number of examples (remembering that the success of this method is in making the appropriate substitution). The basic steps in integration by substitution can be summarised as follows:

1. Define u (i.e., let u be a function of the variable which is part of the integrand).
2. Convert the integrand from an expression in *the original variable* to an expression in u (this means that you also need to convert the ' dx ' term to a ' du ' term – if the original variable is x).
3. Integrate and then rewrite the answer in terms of x (by substituting back for u).

NB: This is only a guide, you may very well skip steps or use a slightly different approach.

EXAMPLE 23.7

Find

$$(a) \int (2x+1)^4 dx \quad (b) \int 2x(x^2+1)^3 dx \quad (c) \int \frac{x^2}{\sqrt{x^3-4}} dx$$

S
o
i
l
u
t
i
o
n

- (a) Although this integral can be evaluated by making use of the general power rule, we use the substitution method to illustrate the process:

$$\text{In this case we let } u = 2x + 1 \Rightarrow \frac{du}{dx} = 2 \therefore dx = \frac{1}{2} du.$$

Having chosen u , we have also obtained an expression for dx , we are now in a position to carry out the substitution for the integrand:

$$\int (2x+1)^4 dx = \int u^4 \times \left(\frac{1}{2} du\right) = \frac{1}{2} \int u^4 du = \frac{1}{2} \times \frac{1}{5} u^5 + c = \frac{1}{10} u^5 + c$$

$$\text{Substituting back we obtain an expression in terms of } x: = \frac{1}{10} (2x+1)^5 + c$$

MATHEMATICS – Higher Level (Core)

- (b) This time, we let $u = x^2 + 1$.

Note the difference between this substitution and the one used in (a). We are making a substitution for a non-linear term!

$$\text{Now, } u = x^2 + 1 \Rightarrow \frac{du}{dx} = 2x \therefore \frac{1}{2}du = xdx.$$

Although there is an x attached to the dx term, hopefully, when we carry out the substitution, everything will fall into place.

$$\begin{aligned}\text{Now, } \int 2x(x^2 + 1)^3 dx &= \int 2(x^2 + 1)^3 x dx && \text{[We have moved the } x \text{ next to the } dx\text{.]} \\ &= \int 2u^3 \times \frac{1}{2} du && \text{[Substituting } xdx \text{ for } \frac{1}{2} du \text{.]} \\ &= \frac{1}{4} u^4 + c \\ &= \frac{1}{4} (x^2 + 1)^3 + c\end{aligned}$$

NB: A second (alternate) method is to obtain an expression for dx in terms of one or both variables. Make the substitution and then simplify. Although there is some dispute as to the ‘validity’ of this method, in essence it is the same. We illustrate this now:

- (c) Let $u = x^3 - 4 \Rightarrow \frac{du}{dx} = 3x^2 \therefore dx = \frac{1}{3x^2} du$, making the substitution for u and dx , we

$$\begin{aligned}\text{have: } \int \frac{x^2}{\sqrt{x^3 - 4}} dx &= \int \frac{\cancel{x^2}}{\sqrt{u}} \times \frac{1}{\cancel{3x^2}} du = \frac{1}{3} \int u^{-1/2} du \quad \text{[Notice the } x^2 \text{ terms cancel!]} \\ &= \frac{2}{3} u^{1/2} + c \\ &= \frac{2}{3} \sqrt{x^3 - 4} + c\end{aligned}$$

EXAMPLE 23.8

Find $\int x\sqrt{x-1} dx$.

S
i
u
t
i
o
n

Letting $u = x - 1 \Rightarrow \frac{du}{dx} = 1 \therefore du = dx$. This then gives $\int x\sqrt{x-1} dx = \int x\sqrt{u} du$.

We seem to have come at an impasse. After carrying out the substitution we are left with two variables, x and u , and we need to integrate with respect to u ! This is a type of integrand where not only do we substitute for the $x - 1$ term, but we must also substitute for the x term that has remained as part of the integrand, from $u = x - 1$ we have $x = u + 1$.

$$\begin{aligned}\text{Therefore, } \int x\sqrt{x-1} dx &= \int x\sqrt{u} du = \int (u + 1)u^{1/2} du = \int (u^{3/2} + u^{1/2}) du \\ &= \frac{2}{5} u^{5/2} + \frac{2}{3} u^{3/2} + c \\ &= \frac{2}{5} \sqrt{(x-1)^5} + \frac{2}{3} \sqrt{(x-1)^3} + c\end{aligned}$$

EXAMPLE 23.9

The gradient at any point on the curve $y = f(x)$ is given by the equation

$$\frac{dy}{dx} = \frac{1}{\sqrt{x+2}}. \text{ The curve passes through the point } (2,3). \text{ Find the equation of this curve.}$$

S
o
l
u
t
i
o
n

Integrating both sides of $\frac{dy}{dx} = \frac{1}{\sqrt{x+2}}$ with respect to x , we have $\int \frac{dy}{dx} dx = \int \frac{1}{\sqrt{x+2}} dx$.

Let $u = x+2 \Rightarrow \frac{du}{dx} = 1 \therefore du = dx$. So, $\int \frac{1}{\sqrt{x+2}} dx = \int \frac{1}{\sqrt{u}} du = \int u^{-1/2} du = 2\sqrt{u} + c$

Therefore, we have $y = f(x) = 2\sqrt{x+2} + c$.

Now, $f(2) = 3 \Rightarrow 3 = 2\sqrt{4} + c \Leftrightarrow c = -1$.

Therefore, $f(x) = 2\sqrt{x+2} - 1$.

EXAMPLE 23.10

Find the indefinite integral of the following

(a) $x^2 e^{x^3+4}$ (b) $e^x \cos(e^x)$ (c) $\frac{3x}{x^2+4}$ (d) $x^2 \sqrt{x+1}$

S
o
l
u
t
i
o
n

(a) Let $u = x^3 + 4 \Rightarrow \frac{du}{dx} = 3x^2 \therefore \frac{1}{3x^2} du = dx$.

$$\begin{aligned} \text{Substituting we have } \int x^2 e^{x^3+4} dx &= \int \cancel{x^2} e^u \times \frac{1}{\cancel{3x^2}} du = \frac{1}{3} \int e^u du \\ &= \frac{1}{3} e^u + c \\ &= \frac{1}{3} e^{x^3+4} + c \end{aligned}$$

(b) Let $u = e^x \Rightarrow \frac{du}{dx} = e^x \therefore dx = \frac{1}{e^x} du$.

$$\begin{aligned} \text{Substituting we have } \int e^x \cos(e^x) dx &= \int e^x \cos u \times \frac{1}{e^x} du = \int \cos u du \\ &= \sin u + c \\ &= \sin(e^x) + c \end{aligned}$$

(c) Let $u = x^2 + 4 \Rightarrow \frac{du}{dx} = 2x \therefore dx = \frac{1}{2x} du$.

$$\begin{aligned} \text{Substituting we have } \int \frac{3x}{x^2+4} dx &= \int \frac{\cancel{3x}}{u} \times \frac{1}{\cancel{2x}} du = \frac{3}{2} \int \frac{1}{u} du = \frac{3}{2} \ln u + c \\ &= \frac{3}{2} \ln(x^2+4) + c \end{aligned}$$

(d) Let $u = x+1 \Rightarrow \frac{du}{dx} = 1 \therefore dx = du$.

Substituting we have $\int x^2 \sqrt{x+1} dx = \int x^2 \sqrt{u} du$. Then, as there is still an x term in the

integrand we will need to make an extra substitution. From $u = x + 1$ we have $x = u - 1$.

$$\begin{aligned} \text{Therefore, } \int x^2 \sqrt{u} du &= \int (u - 1)^2 \sqrt{u} du = \int (u^2 - 2u + 1) u^{1/2} du \\ &= \int (u^{5/2} - 2u^{3/2} + u^{1/2}) du \\ &= \frac{2}{7} u^{7/2} - \frac{4}{5} u^{5/2} + \frac{2}{3} u^{3/2} + c \\ &= \frac{2}{7} (x + 1)^{7/2} - \frac{4}{5} (x + 1)^{5/2} + \frac{2}{3} (x + 1)^{3/2} + c \end{aligned}$$

EXAMPLE 23.11

Find the indefinite integral of the following

- (a) $\int \sin 3x \cos^2 3x \, dx$ (b) $\int \frac{\sin 2x}{5 + \cos 2x} \, dx$ (c) $\int \frac{\arctan x}{x^2 + 1} \, dx$

S
O
L
V
E
D
E
D
E
D

(a) Let $u = \cos 3x \Rightarrow \frac{du}{dx} = -3 \sin 3x \therefore dx = -\frac{1}{3 \sin 3x} du$.

Substituting we have $\int \sin 3x \cos^2 3x \, dx = \int \cancel{\sin 3x} u^2 - \frac{1}{\cancel{3 \sin 3x}} du$

$$\begin{aligned} &= -\frac{1}{3} \int u^2 du \\ &= -\frac{1}{3} \cdot \frac{1}{3} u^3 + c \\ &= -\frac{1}{9} \cos^3 3x + c \end{aligned}$$

(b) Let $u = 5 + \cos 2x \Rightarrow \frac{du}{dx} = -2 \sin 2x \therefore dx = -\frac{1}{2 \sin 2x} du$.

Substituting we have $\int \frac{\sin 2x}{5 + \cos 2x} \, dx = \int \frac{\cancel{\sin 2x}}{u} \times -\frac{1}{\cancel{2 \sin 2x}} du$

$$\begin{aligned} &= -\frac{1}{2} \int \frac{1}{u} du \\ &= -\frac{1}{2} \ln u + c \\ &= -\frac{1}{2} \ln(5 + \cos 2x) + c \end{aligned}$$

(c) Let $u = \arctan x \Rightarrow \frac{du}{dx} = \frac{1}{1 + x^2} \therefore dx = (1 + x^2) du$.

Substituting we have $\int \frac{\arctan x}{x^2 + 1} \, dx = \int \frac{u}{x^2 + 1} \times (1 + x^2) du = \int u du$

$$\begin{aligned} &= \frac{1}{2} u^2 + c \\ &= \frac{1}{2} (\arctan x)^2 + c \end{aligned}$$

When using the substitution method to evaluate a definite integral, it is generally more efficient to transform the terminals (limits) of the integral as well as the integrand. This process is illustrated by the following examples:

EXAMPLE 23.12

Evaluate

$$(a) \int_1^2 xe^{x^2} dx \quad (b) \int_1^3 \sqrt{2x+3} dx \quad (c) \int_0^2 \sqrt{4-x^2} dx$$

S
o
l
u
t
i
o
n

(a) $\int_1^2 xe^{x^2} dx$. This is solved using the substitution $u = x^2$, $\frac{du}{dx} = 2x$. The integrand is transformed to $\int xe^{x^2} dx = \int \frac{1}{2} e^u du = \frac{1}{2} e^{x^2} + c$.

Having established that the substitution will work, we can now use it to transform the terminals.

The lower terminal is $x = 1 \Rightarrow u = 1^2 = 1$ and the upper terminal is $x = 2 \Rightarrow u = 2^2 = 4$

$$\begin{aligned} \text{Thus: } \int_1^2 xe^{x^2} dx &= \int_1^4 \frac{1}{2} e^u du = \frac{1}{2} [e^u]_1^4 \\ &= \frac{1}{2} (e^4 - e) \end{aligned}$$

(b) $\int_1^3 \sqrt{2x+3} dx$. Use $u = 2x+3$, $\frac{du}{dx} = 2$ & $x = 1 \Rightarrow u = 5$, $x = 3 \Rightarrow u = 9$

$$\begin{aligned} \int_1^3 \sqrt{2x+3} dx &= \int_5^9 \frac{1}{2} u^{1/2} du = \frac{1}{2} \left[\frac{2}{3} u^{3/2} \right]_5^9 \\ &= \frac{1}{3} (9^{3/2} - 5^{3/2}) \\ &= \frac{1}{3} (27 - 5\sqrt{5}) \end{aligned}$$

(c) $\int_0^2 \sqrt{4-x^2} dx$. Let $x = 2 \sin \theta$, $\frac{dx}{d\theta} = 2 \cos \theta$.

The terminals transform to: $x = 0 \Rightarrow 0 = 2 \sin \theta \Rightarrow \theta = 0$

$$x = 2 \Rightarrow 2 = 2 \sin \theta \Rightarrow \theta = \frac{\pi}{2}.$$

$$\begin{aligned} \therefore \int_0^2 \sqrt{4-x^2} dx &= \int_0^{\pi/2} \sqrt{4-4\sin^2 \theta} \times 2 \cos \theta d\theta = \int_0^{\pi/2} 2\sqrt{1-\sin^2 \theta} \times 2 \cos \theta d\theta \\ &= 2 \int_0^{\pi/2} 2 \cos^2 \theta d\theta \\ &= 2 \int_0^{\pi/2} (1 + \cos 2\theta) d\theta \\ &= 2 \left[\theta + \frac{1}{2} \sin 2\theta \right]_0^{\pi/2} \\ &= \pi \end{aligned}$$

EXERCISES 23.1.2

1. Find the following, using the given u substitution

- | | |
|---|--|
| (a) $\int 2x\sqrt{x^2+1} dx, u = x^2+1$ | (b) $\int 3x^2\sqrt{x^3+1} dx, u = x^3+1$ |
| (c) $\int 2x^3\sqrt{4-x^4} dx, u = 4-x^4$ | (d) $\int \frac{3x^2}{x^3+1} dx, u = x^3+1$ |
| (e) $\int \frac{x}{(3x^2+9)^4} dx, u = 3x^2+9$ | (f) $\int 2xe^{x^2+4} dx, u = x^2+4$ |
| (g) $\int \frac{2z+4}{z^2+4z-5} dz, u = z^2+4z-5$ | (h) $\int t \cdot \sqrt[3]{2-t^2} dt, u = 2-t^2$ |
| (i) $\int \cos x e^{\sin x} dx, u = \sin x$ | (j) $\int \frac{e^x}{e^x+1} dx, u = e^x+1$ |
| (k) $\int \cos x \sin^4 x dx, u = \sin x$ | (l) $\int x\sqrt{x+1} dx, u = x+1$ |

2. Using the substitution method, find

- | | | |
|--------------------------------------|---------------------------------------|-------------------------------------|
| (a) $\int x\sqrt{2x-1} dx$ | (b) $\int x^2\sqrt{1-x} dx$ | (c) $\int (x+1)\sqrt{x-1} dx$ |
| (d) $\int \sec^2 x e^{\tan x} dx$ | (e) $\int \frac{4x}{(1-2x^2)} dx$ | (f) $\int \frac{4x}{(1-2x^2)^2} dx$ |
| (g) $\int \frac{1}{x} (\log_e x) dx$ | (h) $\int \frac{e^{-x}}{1+e^{-x}} dx$ | (i) $\int \frac{1}{x \log_e x} dx$ |

3. Using an appropriate substitution, evaluate the following (giving exact values)

- | | | |
|---|--|--|
| (a) $\int_{-1}^1 \frac{2x}{x^2+1} dx$ | (b) $\int_0^1 \frac{2x^2}{x^3+1} dx$ | (c) $\int_{10}^{12} \frac{2x+1}{x^2+x-2} dx$ |
| (d) $\int_0^{\frac{\pi}{2}} \frac{\cos x}{1+\sin x} dx$ | (e) $\int_0^{\frac{\pi}{12}} \frac{\sec^2 3x}{1+\tan 3x} dx$ | (f) $\int_0^1 \frac{x}{(1+x^2)^2} dx$ |
| (g) $\int_0^1 4x\sqrt{4+5x^2} dx$ | (h) $\int_{-1}^2 x\sqrt{x-1} dx$ | (i) $\int_{-1}^1 e^x\sqrt{e^x+1} dx$ |

4. Using an appropriate substitution, evaluate the following (giving exact values)

- | | | |
|------------------------------------|---|---|
| (a) $\int_1^2 x\sqrt{x^2+3} dx$ | (b) $\int_0^{\frac{\pi}{2}} 3x \sin(4x^2+\pi) dx$ | (c) $\int_{-1}^1 (3x+2)^4 dx$ |
| (d) $\int_{-2}^1 \frac{1}{x+3} dx$ | (e) $\int_0^{\frac{\pi}{2}} \frac{1}{1+\cos x} dx$ | (f) $\int_1^2 5xe^{(2x^2-3)} dx$ |
| (g) $\int_{-1}^1 (3-2x)^7 dx$ | (h) $\int_{\frac{1}{3}}^{\frac{1}{2}} \frac{1}{(1-x)\sqrt{1-x^2}} dx$ | (i) $\int_{\frac{\pi}{4}}^{\frac{\pi}{3}} \frac{1}{\sin 2x} dx$ |

5. Using an appropriate substitution, find (giving exact values where required)

$$(a) \int_0^{\frac{\pi}{2}} \sin^3 x \cos x dx \quad (b) \int_{\frac{\pi}{6}}^{\frac{\pi}{3}} \sin x \sec^2 x dx \quad (c) \int_0^{\frac{\pi}{3}} \cos^3 x \sin 2x dx$$

$$(d) \int_0^{\frac{\pi}{3}} \frac{\sin 2x}{\sqrt{\cos^3 x}} dx \quad (e) \int_0^{\frac{\pi}{2}} \frac{\sin 2x}{1 + \cos^2 x} dx \quad (f) \int_0^{\frac{\pi}{2}} \cos^3 x dx$$

6. Using an appropriate substitution, find (giving exact values where required)

$$(a) \int_{-2}^{-1} x \sqrt{x+2} dx \quad (b) \int_{-1}^2 x \sqrt{2-x} dx \quad (c) \int_3^6 \frac{x}{\sqrt{x-2}} dx$$

$$(d) \int_{-1}^0 \frac{x}{\sqrt{x+1}} dx \quad (e) \int_{-2}^0 (x-2) \sqrt{x+2} dx \quad (f) \int_2^5 \frac{x+1}{x-1} dx$$

7. Find the following indefinite integrals

$$(a) \int \frac{1}{x^2 + 6x + 10} dx \quad (b) \int \frac{1}{x^2 - x + 1} dx \quad (c) \int \frac{1}{\sqrt{1 + 4x - x^2}} dx$$

$$(d) \int \frac{3}{\sqrt{8 - 2x - x^2}} dx \quad (e) \int \frac{2}{\sqrt{5 + 3x - x^2}} dx \quad (f) \int \frac{x}{\sqrt{9 - x^4}} dx$$

$$(g) \int \frac{\arcsin x}{\sqrt{1 - x^2}} dx \quad (h) \int \frac{(\arccos x)^2}{\sqrt{1 - x^2}} dx \quad (i) \int \frac{1}{\arcsin^3 x \sqrt{1 - x^2}} dx$$

8. (a) Given that $\frac{2 - x^2}{(x^2 + 1)(x^2 + 4)} \equiv \frac{A}{x^2 + 1} + \frac{B}{x^2 + 4}$ find A and B.

(b) Hence show that $\int_0^1 \frac{2 - x^2}{(x^2 + 1)(x^2 + 4)} dx = \arctan\left(\frac{1}{3}\right)$

9. (a) Find $\int_0^k \frac{1}{x^2 + 1} dx, k > 0$.

(b) Evaluate the definite integral in (a) for i. $k = \frac{1}{\sqrt{3}}$ ii. $k = 1$

(c) Find $\lim_{k \rightarrow \infty} \int_0^k \frac{1}{x^2 + 1} dx$. Hence, find $\int_{-\infty}^{\infty} \frac{1}{x^2 + 1} dx$.

10. Find $\int \frac{1}{\sqrt{x+1}} dx$. Hence evaluate $\int_0^1 \frac{1}{\sqrt{x+1}} dx$.

11. If $z = cis\theta$, use the expansion of $\left(z - \frac{1}{z}\right)^4$ to show that $8\sin^4\theta = \cos 4\theta - 4\cos 2\theta + 3$.

Hence, using the substitution $x = k\sin^2\theta$, evaluate $\int_0^k x \sqrt{\frac{x}{k-x}} dx, 0 < \theta < \pi$.

12. Using the substitution $x = a(1 + \sin\theta)$ evaluate $\int_a^{2a} \sqrt{2ax - x^2} dx$.

23.2 INTEGRATION BY PARTS

23.2.1 THE BASICS

Consider the indefinite integral $\int x \cos x dx$. Applying any of the techniques we have been using so far will not help us determine the integral. Let us start the process by first finding the derivative of $x \sin x$:

$$\begin{aligned} \frac{d}{dx}(x \sin x) &= \frac{d}{dx}(x) \sin x + x \frac{d}{dx}(\sin x) \\ \therefore \frac{d}{dx}(x \sin x) &= \sin x + x \cos x \end{aligned} \quad \text{[Using product rule]}$$

We observe that the term $x \cos x$ has now appeared on the R.H.S. we can then write

$$\begin{aligned} x \cos x &= \frac{d}{dx}(x \sin x) - \sin x \\ \therefore \int x \cos x dx &= \int \left[\frac{d}{dx}(x \sin x) - \sin x \right] dx \\ &= x \sin x + \cos x + c \end{aligned}$$

Such a process requires considerable foresight. However, this integrand falls into a category of integrands that can be antidifferentiated via a technique known as **integration by parts**. The method is identical to that which we have just used in determining $\int x \cos x dx$. We develop a general expression for integrands that involve a **product** of two functions.

Step 1: Consider the product $u(x)v(x)$.

Step 2: Using the product rule for differentiation we have:

$$\frac{d}{dx}(u(x)v(x)) = u(x) \frac{dv}{dx} + v(x) \frac{du}{dx}.$$

Step 3: Integrating both sides with respect to x gives:

$$u(x)v(x) = \int u(x) \frac{dv}{dx} dx + \int v(x) \frac{du}{dx} dx$$

Step 4: Rearranging, to obtain $\int u(x) \frac{dv}{dx} dx$, we have

$$\int u(x) \frac{dv}{dx} dx = u(x)v(x) - \int v(x) \frac{du}{dx} dx$$

In the case above, we would set, $u(x) = x$ and $\frac{dv}{dx} = \cos x$ and the result would then follow through.

The success of this technique is dependent on your ability to identify the ‘correct’ $u(x)$ and $v(x)$. For example, had we used $u(x) = \cos x$ and $\frac{dv}{dx} = x$, we would have the expression

$$\int x \cos x dx = \frac{1}{2} x^2 \cos x - \int \frac{1}{2} x^2 (-\sin x) dx \text{ – which is not helpful.}$$

We now consider a number of examples to highlight the process involved.

EXAMPLE 23.13

Evaluate: (a) $\int x \cos x dx$ (b) $\int_3^x e^{2x} dx$

S
o
l
u
t
i
o
n

(a) $\int x \cos x dx$. Applying the parts formula with $u(x) = x$ and $\frac{dv}{dx} = \cos x$, from which it follows that $v(x) = \sin x$ gives:

$$\begin{aligned} \int u(x) \frac{dv}{dx} dx &= u(x)v(x) - \int v(x) \frac{du}{dx} dx \\ \int x \cos x dx &= x \times \sin x - \int \sin x \times 1 dx \\ &= x \sin x - (-\cos x) + c \\ &= x \sin x + \cos x + c \end{aligned}$$

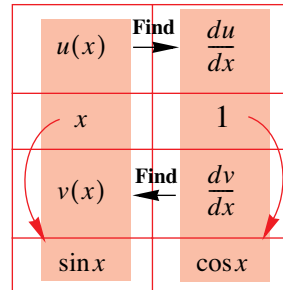

You should check that this is correct by differentiating the answer.

Many people remember the ‘parts formula’ by thinking of the question as consisting of two parts each of which are functions of the independent variable. One of these functions is to be integrated and the other differentiated. Obviously it pays to select a function that becomes simpler in derivative form to be the ‘part’ that is differentiated. Often, though not always, this will be the polynomial part.

(b) $\int_3^x e^{2x} dx$. In this case we choose the function to be differentiated as $u(x) = \frac{x}{3}$ and the function to be integrated as $\frac{dv}{dx} = e^{2x} \Rightarrow v(x) = \frac{1}{2}e^{2x}$

$$\begin{aligned} \int u(x) \frac{dv}{dx} dx &= u(x)v(x) - \int v(x) \frac{du}{dx} dx \\ \int \frac{x}{3} e^{2x} dx &= \frac{x}{3} \times \frac{1}{2} e^{2x} - \int \frac{1}{2} e^{2x} \times \frac{1}{3} dx \\ &= \frac{x}{6} e^{2x} - \frac{1}{12} e^{2x} + c \end{aligned}$$

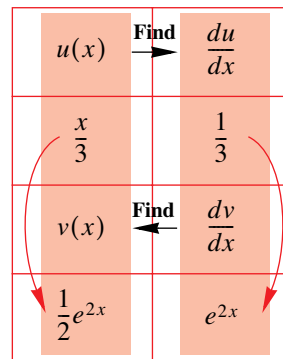

EXERCISES 23.2.1

1. Integrate the following expressions with respect to x :

- (a) $x \sin x$ (b) $x \cos \frac{x}{2}$ (c) $2x \sin \frac{x}{2}$ (d) xe^{-x}
 (e) $5xe^{-4x}$ (f) $\ln x$ (g) $x \ln x$ (h) $-x \cos(-5x)$
 (i) $4x \sin\left(-\frac{x}{3}\right)$ (j) $\frac{x}{\cos^2 x}$ (k) $\sqrt{x} \ln x$

2. Use integration by parts to antidifferentiate

- (a) $x\sqrt{x+1}$ (b) $x\sqrt{x-2}$ (c) $(x+1)\sqrt{x+2}$

3. Find

- (a) $\int \cos^{-1} x dx$ (b) $\int \tan^{-1} x dx$ (c) $\int \sin^{-1} x dx$

4. Find

- (a) $\int x \cos^{-1} x dx$ (b) $\int x \tan^{-1} x dx$ (c) $\int x \sin^{-1} x dx$

5. Find

- (a) $\int_0^{\frac{\pi}{4}} x \sin 2x dx$ (b) $\int_0^1 x e^{2x} dx$ (c) $\int_1^{(e-1)} x \ln(x+1) dx$
 (d) $\int_1^2 (x-1) \ln x dx$ (e) $\int_{\frac{\pi}{8}}^{\frac{\pi}{4}} x \cos 2x dx$ (f) $\int_1^e \frac{\ln x}{x} dx$

6. Find $\int_0^1 x^2 \tan^{-1} x dx$.

7. Show that $\frac{d}{dx}[\ln(\sec x + \tan x)] = \sec x$. Hence find $\int_0^{\frac{\pi}{4}} \sec^3 x dx$.

8. Find (a) $\int \cos(\ln x) dx$ (b) $\int \sin(\ln x) dx$ (c) $\int x^3 \sqrt{1-x^2} dx$

23.2.2 REPEATED INTEGRATION BY PARTS

In the set of Exercises 23.2.1., Q.7., required the repeated use of integration by parts. There will be occasions on which you will need to use the ‘parts’ formula more than once to evaluate an integral. We use the following examples to illustrate this process.

EXAMPLE 23.14

Evaluate: (a) $\int x^2 \cos 2x dx$ (b) $\int e^{2x} \sin \frac{x}{3} dx$

$$\begin{aligned}
 \text{(a)} \quad \int x^2 \cos 2x dx &= x^2 \times \frac{1}{2} \sin 2x - \int 2x \times \frac{1}{2} \sin 2x dx && \left[\text{using } u = x^2, \frac{dv}{dx} = \cos 2x \right] \\
 &= \frac{1}{2} x^2 \sin 2x - \int x \sin 2x dx && \text{Repeated use of} \\
 & && \text{'parts' formula.} \\
 &= \frac{1}{2} x^2 \sin 2x - \left(x \times \frac{1}{2} \cos 2x - \int \left(-\frac{1}{2} \cos 2x \right) dx \right) \\
 &= \frac{1}{2} x^2 \sin 2x + \frac{1}{2} x \cos 2x - \frac{1}{4} \sin 2x + c
 \end{aligned}$$

$$\begin{aligned}
 \text{(b)} \quad \int e^{2x} \sin \frac{x}{3} dx &= e^{2x} \times -3 \cos \frac{x}{3} - \int 2e^{2x} \times -3 \cos \frac{x}{3} dx && \left[\text{Leave constant out for now} \right] \\
 &= -3e^{2x} \cos \frac{x}{3} - \left(-18e^{2x} \sin \frac{x}{3} - \int -36e^{2x} \sin \frac{x}{3} dx \right) \\
 &= -3e^{2x} \cos \frac{x}{3} + 18e^{2x} \sin \frac{x}{3} - 36 \int e^{2x} \sin \frac{x}{3} dx
 \end{aligned}$$

The required integral appears on both sides of this equation, which rearranges to:

$$\begin{aligned}
 37 \int e^{2x} \sin \frac{x}{3} dx &= -3e^{2x} \cos \frac{x}{3} + 18e^{2x} \sin \frac{x}{3} \\
 \therefore \int e^{2x} \sin \frac{x}{3} dx &= -\frac{3}{37} e^{2x} \cos \frac{x}{3} + \frac{18}{37} e^{2x} \sin \frac{x}{3} + c
 \end{aligned}$$

EXERCISES 23.2.2

1. Find the following integrals (not all are best evaluated using the parts formula):

(a) $\int x^2 e^x dx$	(b) $\int 3x^2 \cos(2x) dx$	(c) $\int x^3 \ln(2x) dx$
(d) $\int e^x \sin(2x) dx$	(e) $\int x^2 \cos(3x) dx$	(f) $\int e^{-2x} \cos(2x) dx$
(g) $\int 4x^3 \sin \frac{x}{2} dx$	(h) $\int \frac{1}{x} \ln x dx$	(i) $\int (\ln(3x))^2 dx$
(j) $\int \cos x \sin(2x) dx$	(k) $\int e^{ax} \cos \frac{x}{a} dx$	(l) $\int x^2 \sqrt{x+2} dx$
(m) $\int x^3 \ln(ax) dx$	(n) $\int \frac{x^2}{\sqrt{4-x^2}} dx$	(o) $\int \frac{3x^2 dx}{\sqrt{x^2-9}}$
(p) $\int \frac{x}{x^2+4} dx$	(q) $\int \frac{x^2}{x^2+4} dx$	

2. Evaluate the following

(a) $\int_0^{\frac{\pi}{2}} x \cos^2 x dx$	(b) $\int_0^{\frac{\pi}{2}} x \sin x \cos x dx$	(c) $\int_{\frac{\pi}{2}}^{2\pi} e^x \cos x dx$
(d) $\int_0^{\ln 2} x^2 e^{-x} dx$	(e) $\int_{\frac{\pi}{b}}^{\frac{2\pi}{b}} e^{ax} \cos b x dx$	(f) $\int_1^e (\ln x)^2 dx$

23.3 APPLICATIONS

As we saw in Chapter 22, the applications of integration are many and varied. Although the applications do not vary, we are now in a position to evaluate a larger range of integrals using the techniques covered in this chapter. To this end, we provide a set of exercises that will require the techniques and theory that have been covered in this and the previous chapter.

EXERCISES 23.3

1. Find the area of the region enclosed by the curve $y = \frac{x^2}{x^3 + 1}$ and the lines $x = 0$ and $x = 2$.

2. The velocity, $v(t)$ ms^{-1} , of an object travelling along a straight line, at time t seconds is given by

$$v(t) = 10e^{-\frac{1}{2}t} \sin \frac{\pi}{2}t, 0 \leq t \leq 8.$$

- How far has the particle travelled in the first second of motion?
- What is the particle's displacement after 4 seconds of motion?
- How far has the particle travelled in its 8 seconds of motion?

3. Find the volume of the solid of revolution generated when the plane bounded by the curve $y = \frac{\ln x}{\sqrt{x}}$, and the lines $x = 1$ and $x = e$ is rotated about the x -axis.

- On the same set of axes sketch the graphs of the functions $f(x) = \sin^{-1}x$ and $g(x) = \cos^{-1}x$.
- Show that $\{x : \cos^{-1}x = \sin^{-1}x\} = \{x : x = \sqrt{1 - x^2}\}$.
- Find the area of the region enclosed by the curves and the x -axis.
 - Find the area of the region enclosed by the curves and the y -axis.
- Find the volume of the solid of revolution generated when the plane defined in part (c) ii., is rotated about the y -axis.

- Find the area of the region bounded by the curve $y = e^{-x} \cos \frac{1}{2}x, 0 \leq x \leq 4\pi$ and the x -axis.
 - Find the volume of the solid of revolution generated when the plane defined in part (a) is rotated about the x -axis.

6. The probability density function is defined by $f(x) = \begin{cases} \frac{k}{x} \sqrt{x^2 - 4} & \text{if } 2 \leq x \leq 4 \\ 0 & \text{elsewhere} \end{cases}$.

- Find k .
- Find $p(X > 3)$.

24.1 DIFFERENTIAL EQUATIONS

24.1.1 WHAT ARE DIFFERENTIAL EQUATIONS?

An equation involving derivatives of one or more dependent variables with respect to one or more independent variables is called a differential equation (often, simply referred to as a **d.e.**). If this differential equation involves ordinary derivatives of one or more dependent variables with respect to a **single independent variable**, then, we have an **ordinary differential equation**.

Two examples of differential equations are $\frac{dy}{dx} = 4x$, $\frac{d^2y}{dx^2} + 2\frac{dy}{dx} + 1 = 0$. That is, they are equations that satisfy the above description. A **solution** to such equations is an equation relating x and y and **containing no differential coefficients** (or an equation relating the variables involved but no differential coefficients).

For example, if $\frac{dy}{dx} = 3$, we obtain the **general solution** $y = 3x + c$

(after antidifferentiating both sides with respect to the independent variable x). From a graphical point of view, a **differential equation describes a property of a family of curves**. In our case, it describes a family of curves whose gradient is always three. In turn, we obtain the general solution $y = 3x + c$, which represents the family of straight line curves with gradient three.

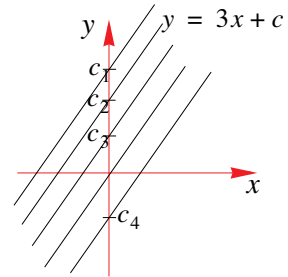

A **particular solution** is the equation of one particular member of that family of curves. In our case, if we also know that for $x = 1$, $y = 5$, we would then have the particular solution $y = 3x + 2$ (i.e., solving for c we have: $5 = 3 \times 1 + c \Leftrightarrow c = 2$). Put simply, we have:

1. A **differential equation** defines some property common to a family of curves.
2. The **general solution**, involving one or more arbitrary constants, is the equation of any member of the family.
3. A **particular solution** is the equation to only one member of the family.

The **order of a differential equation** is determined by the highest differential coefficient. The following serve as examples of differential equations of different order:

1. $\frac{dy}{dx} = 4x$ is of order 1
2. $\frac{d^2y}{dx^2} + 2\frac{dy}{dx} + 1 = 0$ is of order 2
3. $\left(\frac{dy}{dx}\right)^2 + \left(\frac{dy}{dx}\right) = 2$ is of order 1

EXAMPLE 24.1

- Form differential equations for the following
- (a) $y = Bx^2$
 - (b) $T = Ke^{\theta}$

Solution (a) Starting with $y = Bx^2$, when we differentiate both sides with respect to x , we have:

$$y = Bx^2 \Rightarrow \frac{d}{dx}(y) = \frac{d}{dx}(Bx^2) \therefore \frac{dy}{dx} = 2Bx$$

Solution Giving an equation which involves an ordinary derivative of one dependent variable with respect to a single independent variable.

(b) Similarly, $T = Ke^\theta \Rightarrow \frac{dT}{d\theta} = Ke^\theta$ (i.e., differentiating both sides with respect to θ .)

Notice that in this case, Ke^θ is in fact equal to T , therefore, we could write the differential equation as $\frac{dT}{d\theta} = T$.

EXAMPLE 24.2

Form a differential equation for $x^2 + (y - a)^2 = a^2$.

Solution

Differentiate both sides with respect to x :

$$\begin{aligned} \frac{d}{dx}(x^2 + (y - a)^2) &= \frac{d}{dx}(a^2) \\ \Rightarrow 2x + 2(y - a) \cdot \frac{dy}{dx} &= 0 \\ \Leftrightarrow 2(y - a) \cdot \frac{dy}{dx} &= -2x \\ \Leftrightarrow \frac{dy}{dx} &= -\frac{x}{y - a} \end{aligned}$$

So, a differential equation corresponding to $x^2 + (y - a)^2 = a^2$ is $\frac{dy}{dx} = -\frac{x}{y - a}$.

24.1.2 VERIFYING SOLUTIONS

A function is said to be a **solution** of a differential equation if it **satisfies** the differential equation.

EXAMPLE 24.3

Verify that $y = \cos \alpha t$ satisfies the differential equation $\frac{d^2y}{dt^2} = -\alpha^2 y$.

Solution

Given that $y = \cos \alpha t$, we differentiate the equation twice (seeing as the given differential equation contains the second derivative of y with respect to t).

That is, $y = \cos \alpha t \Rightarrow \frac{dy}{dt} = -\alpha \sin \alpha t$,

$$\therefore \frac{d^2y}{dt^2} = -\alpha^2 \cos \alpha t$$

However, we have that $y = \cos \alpha t$, and so, substituting this into the equation, we have that

$\frac{d^2y}{dt^2} = -\alpha^2y$ as required. Therefore, $y = \cos \alpha t$ is a solution of $\frac{d^2y}{dt^2} = -\alpha^2y$

EXAMPLE 24.4

Verify that the function $y = -e^{-x}$ is a solution of the differential equation

$$\frac{dy}{dx} = y^2e^x.$$

Solution

Given that $y = -e^{-x}$, we first differentiate the equation with respect to x : $y = -e^{-x} \Rightarrow \frac{dy}{dx} = e^{-x}$

As it stands, this equation doesn't quite look like the given d.e. Therefore, we need to work with our equation a little further:

We notice that $y = -e^{-x} \Rightarrow y^2 = e^{-2x}$ and so, $y^2 = e^{-x} \times e^{-x} \Rightarrow e^{-x} = y^2e^x$.

We can now substitute this expression for e^{-x} into our d.e. i.e., into $\frac{dy}{dx} = e^{-x}$.

This then gives, $\frac{dy}{dx} = y^2e^x$, as required. That is, $y = -e^{-x}$ satisfies the d.e. $\frac{dy}{dx} = y^2e^x$.

EXAMPLE 24.5

For what values of k is $y = e^{kx}$ a solution of $\frac{d^2y}{dx^2} + 2\frac{dy}{dx} - 8y = 0$?

Solution

Given $y = e^{kx}$, then $\frac{dy}{dx} = ke^{kx}$ and $\frac{d^2y}{dx^2} = k^2e^{kx}$. Substituting these results into the equation

$$\frac{d^2y}{dx^2} + 2\frac{dy}{dx} - 8y = 0, \text{ we have: } k^2e^{kx} + 2ke^{kx} - 8e^{kx} = 0$$

$$\Leftrightarrow e^{kx}(k^2 + 2k - 8) = 0$$

$$\Leftrightarrow e^{kx}(k + 4)(k - 2) = 0$$

However, $e^{kx} > 0$ for all real values of x , therefore, the only solution is $k = -4$ or $k = 2$.

EXERCISES 24.1

1. Verify that

(a) $y = x^5 + 9$ satisfies the differential equation $\frac{dy}{dx} = 5x^4$.

(b) $y = \cos 2x$ satisfies the differential equation $\frac{d^2y}{dx^2} + 4y = 0$.

MATHEMATICS – Higher Level (Core)

(c) $y = \sqrt{x^2 + 1}$ satisfies the differential equation $\frac{dy}{dx} = \frac{x}{y}$.

(d) $y = x \ln(x)$ satisfies the differential equation $x^2 \frac{d^2y}{dx^2} + y = x \frac{dy}{dx}$.

(e) $y = xe^x$ satisfies the differential equation $\frac{dy}{dx} - y = e^x$.

2. Verify that the differential equation

(a) $\frac{dN}{dt} = N(a - bN)$, has a solution given by $N = \frac{ake^{at}}{1 + bke^{at}}$.

(b) $\frac{dM}{dt} = (2 - M)(1 - M)$, has a solution given by $t = \ln\left(\frac{2 - M}{1 - M}\right)$.

3. Verify that $y = e^{3x} \cos 2x$ satisfies the differential equation $\frac{d^2y}{dx^2} - 6\frac{dy}{dx} + 13y = 0$.**4.** Verify that $y = \ln(\cos nx)$ satisfies the differential equation $\frac{dy}{dx} = -ne^{-y} \sqrt{1 - e^{2y}}$.**5.** For what values of m and n , does $y = e^{4x} + e^{-x}$ satisfy the differential equation

$$\frac{d^2y}{dx^2} + m\frac{dy}{dx} + ny = 0?$$

6. Show that $x = 4t + 1$ and $y = t^2 - 2$ satisfy the differential equation $\left(\frac{dy}{dx}\right)^2 = \frac{1}{4}(y + 2)$.**7.** Find the values of k , so that $y = e^{kx}$ is a solution to

(a) $\frac{d^2y}{dx^2} - 5\frac{dy}{dx} + 6y = 0$ (b) $\frac{d^2y}{dx^2} + 6\frac{dy}{dx} + 9y = 0$.

8. Find the values of a and b given that $y = e^{-x} \sin x$ is a solution to the differential

equation $\frac{d^2y}{dx^2} + a\frac{dy}{dx} + by = 0$.

9. Find the values of a and b given that $y = x \cos x$ is a solution to the differential

equation $x^2 \frac{d^2y}{dx^2} + ax \frac{dy}{dx} + (x^2 + b)y = 0$.

10. Obtain a first order differential equation for $(x - a)^2 + ay^2 = a^2 - 2ax$.**11.** (a) Show that $\frac{1}{a} - \frac{1}{a+1} = \frac{1}{a(a+1)}$.

(b) Show that $y = \frac{kx}{1 + (1 - k)x}$ satisfies the d.e. $x(x + 1) \frac{dy}{dx} = y(y + 1)$.

24.2 SOLVING DIFFERENTIAL EQUATIONS

So far we have been ‘solving’ differential equations by verification, that is, knowing the solution, we have verified that it satisfied the given d.e. However, most of the time we do not know the solution to a given differential equation, and so, it is the task of this section to develop techniques that will enable us to find solutions based on a given d.e.

The basic technique involves the process of antidifferentiation (i.e., integration) together with recognition skills. The recognition skills refer to the ability to recognise the ‘type’ of d.e. that we are trying to solve.

Consider the family of curves whose gradient is given by e^{2x} . Expressing this statement as a differential equation we have that $\frac{dy}{dx} = e^{2x}$. To determine the family of curves from this d.e., all we need to do is antidifferentiate (i.e., integrate) both sides with respect to x :

$$\frac{dy}{dx} = e^{2x} \Rightarrow \int \frac{dy}{dx} dx = \int e^{2x} dx$$

So that
$$y = \frac{1}{2}e^{2x} + c$$

And so, we have the **general solution** to the given d.e. Then, if we are given information such as, the curve passes through the point $(0,1)$, we can solve for c : $1 = \frac{1}{2}e^0 + c \Leftrightarrow c = \frac{1}{2}$

Therefore, we have the **particular solution**, $y = \frac{1}{2}e^{2x} + \frac{1}{2}$.

In solving this differential equation, we have already made use of a recognition skill:

We recognised that we could in fact integrate both sides with respect to x . Although this might seem rather straightforward, it is nice to know that there isn’t much more to it—although some approaches will require good recognition skills, good algebraic skills and definitely very good integration skills. We now consider a number of standard types of differential equations and methods for solving them.

Type 1
$$\frac{dy}{dx} = f(x)$$

Solving these types of d.e.s requires that we integrate both sides with respect to x :

That is,
$$\frac{dy}{dx} = f(x) \Rightarrow \int \frac{dy}{dx} dx = \int f(x) dx$$

$$\therefore y = F(x) + c \quad (\text{This is the **general solution**.)}$$

For the **particular solution**, we need some information about the curve, e.g., the curve passes through the point (a,b) , so that $b = F(a) + c \Rightarrow c = b - F(a)$, and so, we have a particular solution:

$$\therefore y = F(x) + b - F(a)$$

EXAMPLE 24.5

Solve the differential equation $\frac{dy}{dx} = \frac{2x}{x^2 + 4}$, given that the curve passes through the point (0,4).

S
o
l
u
t
i
o
n

Because the differential equation is of the form $\frac{dy}{dx} = f(x)$, we can integrate both sides with respect to x (i.e., b.s.w.r.t. x):

$$\text{i.e.,} \quad \int \frac{dy}{dx} dx = \int \frac{2x}{x^2 + 4} dx \Rightarrow y = \log(x^2 + 4) + c$$

As the curve passes through the point (0, 4), we have; $4 = \log_e 4 + c \Rightarrow c = 4 - \log_e 4$.

Therefore, we have; $y = \log(x^2 + 4) + 4 - \log_e 4$

$$\therefore y = \log\left(\frac{x^2 + 4}{4}\right) + 4.$$

EXAMPLE 24.6

Solve the differential equation $x \frac{dy}{dx} = \ln x$, given that the curve passes through the point (e,1).

S
o
l
u
t
i
o
n

As it is presented, the d.e. $x \frac{dy}{dx} = \ln x$ is not quite in the form $\frac{dy}{dx} = f(x)$.

However, we can rearrange the equation to give

$$\frac{dy}{dx} = \frac{\ln x}{x} \quad (\text{Which is now in the form } \frac{dy}{dx} = f(x))$$

$$\Rightarrow \int \frac{dy}{dx} dx = \int \frac{\ln x}{x} dx$$

$$\int \frac{dy}{dx} dx = \int \frac{1}{x} \cdot \ln x dx$$

$$\therefore y = \frac{1}{2}(\ln x)^2 + c$$

i.e., we recognised the integral as $\int h'(x)[h(x)]^n dx = \frac{1}{n+1}[h(x)]^{n+1} + c$ where $h(x) = \ln x$.

That is, we have a general solution $y = \frac{1}{2}(\ln x)^2 + c$. To find the particular solution we use the

fact that when $x = e, y = 1$. So, $1 = \frac{1}{2}(\ln e)^2 + c \Rightarrow c = \frac{1}{2}$.

Therefore, we have that $y = \frac{1}{2}(\ln x)^2 + \frac{1}{2}, x > 0$.

Type 2 $\frac{dy}{dx} = f(y)$

This time it is not possible to integrate both sides with respect to x directly as we would produce an expression of the form $\int \frac{dy}{dx} dx = \int f(y) dx$, for which the right hand side cannot be integrated.

However, we can first **invert both sides** of the equation, giving the ‘new d.e.’:

$$\frac{dy}{dx} = f(y) \Leftrightarrow \frac{dx}{dy} = \frac{1}{f(y)}$$

where we can now integrate both sides with respect to y :

$$\int \frac{dx}{dy} dy = \int \frac{1}{f(y)} dy \Rightarrow x = F(y) + c$$

That is, we obtain an expression for x in terms of y (as long as integration is possible).

EXAMPLE 24.7

Find the general solution to the differential equation $\frac{dy}{dx} = 5y$.

S
o
l
u
t
i
o
n

- Step 1:** Invert $\frac{dy}{dx} = 5y$: i.e., $\frac{dx}{dy} = \frac{1}{5y}$.
- Step 2:** Antidiff. b.s.w.r.t.y: i.e., $\int \frac{dx}{dy} dy = \int \frac{1}{5y} dy$
- Step 3:** Solve: i.e., $x = \frac{1}{5} \ln y + c, y > 0$

$$\begin{aligned} \therefore 5(x - c) &= \ln y \\ \Leftrightarrow y &= e^{5(x-c)} \end{aligned}$$

We could leave the answer as is, however it is usual to simplify it further:

$$y = e^{5(x-c)} = e^{5x} \times e^{-5c} = Ae^{5x}$$

where $A = e^{-5c}$.

Note, we can do this because c is an arbitrary constant and therefore so is e^{-c} , then we replace it by the arbitrary constant A .

EXAMPLE 24.8

Find the general solution to the differential equation $\frac{dy}{dx} = \frac{y^2 - 1}{2}$.

S
o
l
u
t
i
o
n

Because the differential equation is of the form $\frac{dy}{dx} = f(y)$, we first invert both sides and then we can integrate b.s.w.r.t.y:

$$\frac{dy}{dx} = \frac{y^2 - 1}{2} \Rightarrow \frac{dx}{dy} = \frac{2}{y^2 - 1}$$

We ‘recognise’ that the right hand side can be written as $\frac{2}{y^2-1} = \frac{1}{y-1} - \frac{1}{y+1}$.

Therefore, we have that $\frac{dx}{dy} = \frac{1}{y-1} - \frac{1}{y+1}$

$$\Rightarrow \int \frac{dx}{dy} dy = \int \left(\frac{1}{y-1} - \frac{1}{y+1} \right) dy$$

$$\therefore x = \log_e(y-1) - \log_e(y+1) + c, y > 1$$

$$\therefore x = \log_e\left(\frac{y-1}{y+1}\right) + c, y > 1$$

We can now also solve for y :

$$\therefore x = \log_e\left(\frac{y-1}{y+1}\right) + c, y > 1 \Leftrightarrow \log_e\left(\frac{y-1}{y+1}\right) = x - c, y > 1$$

$$e^{x-c} = \frac{y-1}{y+1}, y > 1$$

$$\Leftrightarrow ke^{x(y+1)} = y-1, y > 1, \text{ where } k = e^{-c}$$

$$\Leftrightarrow ke^x + 1 = y(1 - ke^x), y > 1$$

$$\therefore y = \frac{ke^x + 1}{1 - ke^x}, y > 1$$

Note: Sometimes, rather than inverting both sides of the equation, it is preferable to divide both sides of the equation by the appropriate variable or function.

If we consider Example 24.7 where $\frac{dy}{dx} = 5y$ we could, as the first step, write

$$\frac{1}{y} \frac{dy}{dx} = 5 \quad (\text{i.e., divide by } y)$$

$$\therefore \int \frac{1}{y} \frac{dy}{dx} dx = \int 5 dx$$

$$\therefore \ln y = 5x + c$$

$$\Leftrightarrow y = e^{5x+c}$$

$$\therefore y = Ae^{5x}$$

Where $A = e^c$.

Do not worry about the A s looking different. i.e., in Example 24.7, we had $A = e^{-5c}$ whereas here we have $A = e^c$ – they are in fact the same (because in reality, the ‘ c ’ is different in both cases). Both methods are appropriate.

EXAMPLE 24.9

Solve the differential equation $\frac{dy}{dx} = 2(y+3)^2$ given that $y(0) = 1$. Hence sketch the solution function, $y(x)$.

$$\text{Inverting } \frac{dy}{dx} = 2(y+3)^2 \text{ we have } \frac{dx}{dy} = \frac{1}{2(y+3)^2}, y \neq -3$$

$$\Rightarrow \int \frac{dx}{dy} dy = \int \frac{1}{2(y+3)^2} dy$$

Since the integrand on the R.H.S has a discontinuity at $y = -3$, we obtain two solutions, one for $y > -3$ and one for $y < -3$, giving the solution functions

$$x = -\frac{1}{2(y+3)} + c_1, y > -3 \quad (1)$$

$$x = -\frac{1}{2(y+3)} + c_2, y < -3 \quad (2)$$

However, under the given condition, $x = 0, y = -1$ and so we need to use (1) as the solution.

$$\text{That is, we have } 0 = -\frac{1}{2(2)} + c_1 \Leftrightarrow c_1 = \frac{1}{4}$$

$$\text{Therefore, } x = -\frac{1}{2(y+3)} + \frac{1}{4}, y > -3.$$

$$\text{Solving for } y \text{ we have } x - \frac{1}{4} = -\frac{1}{2(y+3)} \therefore \frac{4x-1}{4} = -\frac{1}{2(y+3)}$$

$$\therefore y+3 = -\frac{2}{4x-1}$$

$$\therefore y = \frac{1-12x}{4x-1}$$

$$\text{Then, as } y > -3 \Rightarrow x < \frac{1}{4} \therefore y = \frac{1-12x}{4x-1}, x < \frac{1}{4}.$$

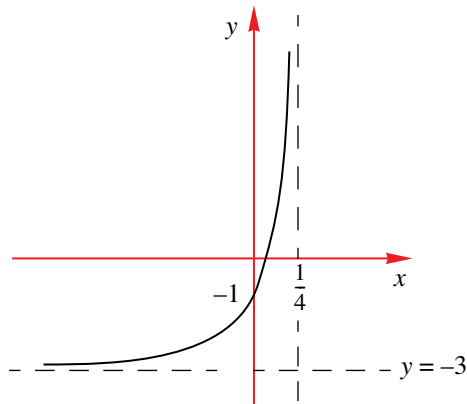

Type 3 $\frac{dy}{dx} = f(x)g(y)$

Equations of this type are known as **separable** differential equations or to have **separable variables**. The reason being that it is possible to ‘separate’ the variables. The solution to these types of d.e.s may then be obtained by integrating both sides with respect to the appropriate variable:

That is, $\frac{dy}{dx} = f(x)g(y)$

$$\Rightarrow \frac{1}{g(y)} \frac{dy}{dx} = f(x) \quad \text{[separating the variables]}$$

$$\Rightarrow \int \frac{1}{g(y)} \frac{dy}{dx} dx = \int f(x) dx \quad \text{[antidiff w.r.t. appropriate variable]}$$

$$\therefore \int \frac{1}{g(y)} dy = \int f(x) dx$$

That is, $\frac{dy}{dx} = f(x)g(y) \Rightarrow \int \frac{1}{g(y)} dy = \int f(x) dx$

Which we can (hopefully) solve, i.e., find an integral for the left hand side and the right hand side.

EXAMPLE 24.10

Find the general solution to the differential equation $\frac{dy}{dx} = \frac{y^2 + 1}{x^2 + 1}$.

**S
o
l
u
t
i
o
n**

This d.e. is of the form $\frac{dy}{dx} = f(x)g(y)$, and so we can ‘separate’ the variables:

$$\frac{dy}{dx} = \frac{y^2 + 1}{x^2 + 1} \Rightarrow \frac{1}{y^2 + 1} \frac{dy}{dx} = \frac{1}{x^2 + 1}$$

Therefore, integrating b.s.w.r.t.x: $\int \frac{1}{y^2 + 1} \frac{dy}{dx} dx = \int \frac{1}{x^2 + 1} dx$

$$\arctan y = -\arctan x + c$$

$$\therefore \arctan y + \arctan x = c$$

$$\Rightarrow \arctan\left(\frac{x+y}{1-xy}\right) = c$$

$$\Rightarrow \frac{x+y}{1-xy} = \tan c$$

$$\Rightarrow y = \frac{k-x}{1+kx}, \text{ where } k = \tan c$$

EXAMPLE 24.11

Find the general solution to the differential equation $(y^2 + 4) \frac{dy}{dx} = yxe^{-x}$.

**S
o
l
u
t
i
o
n**

$$(y^2 + 4) \frac{dy}{dx} = yxe^{-x} \Leftrightarrow \frac{y^2 + 4}{y} \frac{dy}{dx} = xe^{-x}$$

$$\therefore \left(y + \frac{4}{y}\right) \frac{dy}{dx} = xe^{-x}$$

Next we antidifferentiate both sides with respect to x:

$$\begin{aligned} \therefore \int \left(y + \frac{4}{y} \right) \frac{dy}{dx} dx &= \int x e^{-x} dx \\ \Rightarrow \frac{1}{2} y^2 + 4 \ln y &= -e^{-x} - x e^{-x} + c \end{aligned}$$

We leave the solution in its implicit form.

EXERCISES 24.2

1. Find the general solution of the differential equations

$$(a) \quad \frac{dy}{dx} = 1 + \sin 2x \quad (b) \quad \frac{dy}{dx} = \sin^2 x \quad (c) \quad \frac{dy}{dx} = \frac{6x + 3}{x^2 + x}$$

2. Solve the following differential equations

$$\begin{aligned} (a) \quad \sqrt{t} \frac{dy}{dt} - t^2 &= 0, y = 1, t = 1 & (b) \quad \frac{dx}{dt} &= 4 \tan 2t, x(0) = 1 \\ (c) \quad \frac{dy}{dx} &= \frac{2x}{(x-1)(x+1)}, y(2) = 4 & (d) \quad (1-x)^2 \frac{dy}{dx} + 1 &= 0, y(2) = \frac{4}{3} \\ (e) \quad \frac{dv}{dt} &= \frac{k}{(t+t_0)^3}, v(0) = u & (f) \quad \frac{dy}{dx} &= x \cos(x^2), x = 0, y = 0 \\ (g) \quad \frac{1}{\cos t} \left(\frac{dx}{dt} \right) &= 4 \sin^3 t, x(0) = 1 & (h) \quad \frac{dN}{dt} &= t \sqrt{25 + t^2}, N = 5, t = 0 \\ (i) \quad \frac{dT}{d\theta} &= \sin 2\theta \sqrt{8 + \cos 2\theta}, T(0) = 0 & (j) \quad \frac{dP}{dt} &= t e^{-3t}, P(0) = 1 \end{aligned}$$

3. Find the general solution of the differential equations

$$(a) \quad \frac{dy}{dx} = \sqrt{9 - y^2} \quad (b) \quad \frac{dy}{dx} = \frac{1 - y}{2} \quad (c) \quad \frac{dy}{dx} = y(y - 2)$$

4. Solve the following differential equations

$$\begin{aligned} (a) \quad \frac{dN}{dt} &= N^3, t = 0, N = -\frac{1}{2} & (b) \quad \frac{ds}{dt} &= s^2 + 4, s = 0, t = 0 \\ (c) \quad \frac{dp}{dx} &= e^{-2p}, x = \frac{1}{2}, p = 0 & (d) \quad \frac{dy}{dx} &= 9 + y^2, x = 0, y = 3\pi \\ (e) \quad \sqrt{1 - x^2} \frac{dy}{dx} &= 4, y(0) = 2 & (f) \quad \frac{dy}{dx} &= 2(7 - y)^2, y(0) = 0 \\ (g) \quad \frac{dy}{d\theta} &= \sec^2 y, y = \pi, \theta = 0 & (h) \quad \frac{dy}{dx} &= \frac{y^2 + 4}{y^2}, y = 2\pi, x = 0 \end{aligned}$$

MATHEMATICS – Higher Level (Core)

5. Find the general solution of the differential equations

(a) $\frac{dy}{dx} = \frac{y}{x+1}$ (b) $\frac{dy}{dx} = x(y+1)$ (c) $\frac{dy}{dx} = \frac{x}{y+1}$
(d) $\frac{dy}{dx} = \frac{\sin x}{e^y}$ (e) $\frac{dy}{dx} = \frac{x \sin x}{e^y}$ (f) $\frac{dy}{dx} = \frac{x \sin x}{ye^y}$
(g) $x\sqrt{1-y^2}\frac{dy}{dx} = 1$ (h) $x\sqrt{1-y^2}\frac{dy}{dx} = 1$ (i) $\frac{\sqrt{1-y^2}dy}{x} = 1$

6. Solve the following differential equations

(a) $y(4+x^2)\frac{dy}{dx} = 1, x=0, y=1$ (b) $\frac{dy}{dx} = xe^{y-x^2}, x=0, y=0$
(c) $\frac{dy}{dx} = xe^{y-x}, x=0, y=0$ (d) $\frac{dx}{dt} + tx = x, x(1) = 2$

7. Solve the following differential equations

(a) $(1+x^2)dy - x(4+y^2)dx = 0, y(0) = 0$ (b) $\frac{dx}{dt} - tx^2 = t, t(0) = \sqrt{2}$

8. A family of curves is defined by the differential equation $\frac{dy}{dx} = \frac{3-y}{1+2x}$. Find the particular curve that passes through the point (1,2).

9. A family of curves is defined by the differential equation $e^{-x}\frac{dy}{dx} = (1-y)^2$. Find the particular curve that passes through the origin.

10. A family of curves is defined by the differential equation $x^2\frac{dy}{dx} = y - xy$. Find the particular curve that passes through the point (1,1).

11. Solve the differential equation $(1+y)\frac{dy}{dx} + \sin^2 x = 1, x=0, y=0$.

12. By using the substitution $u = x + y$, show that the differential equation $\frac{dy}{dx} = x + y$ can

be reduced to the d.e. $\frac{du}{dx} = u + 1$.

Hence, show that the general solution is given by $x + y + 1 = ke^x$.

13. Using the substitution $u = x + y + 1$, show that the differential equation $\frac{dy}{dx} = \frac{1}{x+y+1}$

can be reduced to the d.e. $\frac{du}{dx} - 1 = \frac{1}{u}$.

Hence, show that the general solution is given by $x + y + 2 = ke^y$.

- 14.** By using the substitution $y = ux$, show that the differential equation

$$x \frac{dy}{dx} = y^2 + x^2 + y \text{ can be reduced to the d.e. } \frac{du}{dx} = u^2 + 1.$$

Hence, show that the general solution is given by $y = x \tan(x + c)$.

- 15.** By using the substitution $y = xu$, show that the differential equation

$$\frac{dy}{dx} = \frac{y + \sqrt{x^2 + y^2}}{x}, x > 0 \text{ can be reduced to the d.e. } x \frac{du}{dx} = \sqrt{u^2 + 1}.$$

Hence, show that if the curve passes through the point $(1, 0)$, the particular solution

$$\text{is given by } y = \frac{1}{2}(x^2 - 1).$$

- 16.** (a) Show that $\frac{1}{4} \left(\frac{1}{a-2} - \frac{1}{a+2} \right) = \frac{1}{a^2-4}$. Hence, find $\int \frac{1}{x^2-4} dx$.

(b) Solve the d.e. $\frac{dy}{dx} = y^2 - 4$, $y(0) = 3$.

(c) Solve the d.e. $\frac{dy}{dx} = y^2 + 4$, $y(0) = -2$

- 17.** (a) Simplify $\frac{1}{y} + \frac{1}{a-y}$.

(b) If $y' = k(a-y)y$, $y(0) = 1$ find the equation $y(x)$.

- 18.** Solve the d.e. $\frac{1+x^2 dy}{1+y^2 dx} + 1 = 0$, $x = 0$, $y = 1$. Sketch the graph of this solution.

- 19.** Given that $y = ae^{-x} + be^{2x}$ find the real values k, m, n such that y satisfies the differential equation $k \frac{d^2y}{dx^2} + m \frac{dy}{dx} + ny = 0$.

- 20.** (a) Show that $\frac{d}{dt}(e^{qt}y) = e^{qt} \left(\frac{dy}{dt} + qy \right)$.

(b) Given the system of differential equations $\frac{dx}{dt} = -px$, $\frac{dy}{dt} = px - qy$.

i. If $x = a$ when $t = 0$, show that $\frac{dy}{dt} = pa e^{-pt} - qy$.

ii. Show that $\frac{d}{dt}(e^{qt}y) = a p e^{-(p-q)t}$.

iii. If $y = 0$ when $t = 0$, show that $y = \frac{ap}{q-p}(e^{-pt} - e^{-qt})$.

- (c) Verify that y has a local maximum. Find when this maximum occurs.

24.3 APPLICATIONS

We find that the formulation of problems in both the physical and the biological sciences often leads to first-order differential equations of the types we have learned to solve. Some such examples are described below:

Population growth:

If N denotes the population size at some time t , where $t \geq t_0$, then one

possible model is given by $\frac{dN}{dt} = kN, k > 0$.

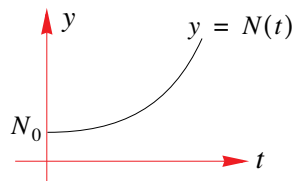

Decay (radiation):

In general we have that the rate of decay is proportional to the amount of substance present at any time t , where $t \geq t_0$.

A possible model is given by $\frac{dN}{dt} = kN, k < 0$.

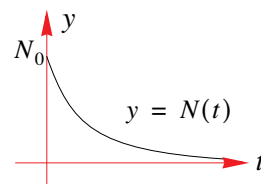

Logistic equation:

Mathematical formulation for predicting the human population of various countries.

One such equation is $\frac{dp}{dt} = p(a - bp)$.

One possible solution

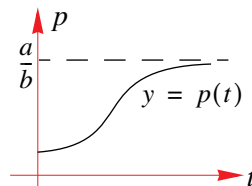

These d.e.s are of the type $\frac{dy}{dx} = f(y)$.

Electric circuit:

For an electrical appliance containing a coil of wire of resistance R , and an inductance L , which is connected to a power supply of $E(t)$ volts, producing a current i , we have the differential equation;

$$L \frac{di}{dt} + Ri = E(t)$$

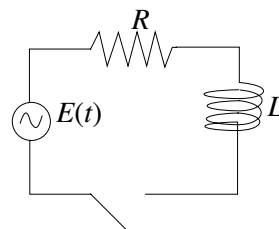

Dynamics of red blood cells:

If $R(t)$ is the number of erythrocytes in the blood of a

human at time t , then the d.e. $\frac{dR}{dt} + bR(t) = \frac{a}{R(t)}$

describes the relationship between R and t .

There are many more examples, some of which cannot be solved by the methods we have learnt so far. Nonetheless, we now consider a number of applied problems.

EXAMPLE 24.14

A container is initially filled with 100 litres of a salt solution containing 100 kg of salt. Fresh brine containing 2 kg of salt per litre runs into a tank at a rate of 5 litres/min, and runs out at the rate same rate. Assuming that the mixture is kept uniform by stirring, the relationship between the amount of salt S kg present in the container and the time t , since the process started, is given by the differential equation $\frac{dS}{dt} = 10 - \frac{1}{20}S$. How long will it take for there to be 140 kg of salt in the container?

**S
o
l
u
t
i
o
n**

Given that $\frac{dS}{dt} = 10 - \frac{1}{20}S$, we have $\frac{dS}{dt} = \frac{200 - S}{20} \Rightarrow \frac{dt}{dS} = \frac{20}{200 - S}$.

Antidifferentiating b.s.w.r.t. S : $\int \frac{dt}{dS} dS = \int \frac{20}{200 - S} dS$

Therefore, $t = -20 \log_e(200 - S) + c, 0 < S < 200$

Given that when $t = 0, S = 100$, we have $0 = -20 \log_e(100) + c \Rightarrow c = 20 \log_e(100)$

Therefore, $t = -20 \log_e(200 - S) + 20 \log_e(100), 0 < S < 200$

That is, $t = 20 \log_e\left(\frac{100}{200 - S}\right), 0 < S < 200$.

Now, when $S = 140$, we have $t = 20 \log_e\left(\frac{100}{200 - 140}\right) \approx 10.22$.

That is, it will take approximately 10 minutes and 13 seconds.

EXAMPLE 24.15

It is thought that the rate at which a rumour spreads is jointly proportional to the number, x , of people who have heard the rumour and the number $N - x$, those who have yet to hear it. This relationship is approximated by the differential equation $\frac{dx}{dt} = kx(N - x)$. Assuming that when $t = 0, x = 1$, find an equation for x as a function of time t .

**S
o
l
u
t
i
o
n**

The differential equation $\frac{dx}{dt} = kx(N - x)$ is of the form $\frac{dy}{dx} = f(y)$, and so we use the

appropriate approach: $\frac{dx}{dt} = kx(N - x) \Rightarrow k \frac{dt}{dx} = \frac{1}{x(N - x)}$

Antidifferentiating b.s.w.r.t. x : $\int k \frac{dt}{dx} dx = \int \frac{1}{x(N - x)} dx$

Expressing $\frac{1}{x(N - x)}$ as $\frac{1}{N}\left(\frac{1}{x} + \frac{1}{N - x}\right)$: $\int k \frac{dt}{dx} dx = \frac{1}{N} \int \left(\frac{1}{x} + \frac{1}{N - x}\right) dx$

$$\therefore kt = \frac{1}{N}(\log_e x - \log_e(N - x)) + c$$

MATHEMATICS – Higher Level (Core)

When $t = 0, x = 1$, which gives, $\therefore 0 = \frac{1}{N}(\log_e 1 - \log_e(N-1)) + c$

$$\Rightarrow c = \frac{1}{N}\log_e(N-1)$$

Therefore, we have, $\therefore kt = \frac{1}{N}(\log_e x - \log_e(N-x)) + \frac{1}{N}\log_e(N-1)$

$$\Rightarrow kt = \frac{1}{N}\log_e\left(\frac{x}{N-x}\right) + \frac{1}{N}\log_e(N-1)$$

$$\Rightarrow kt = \frac{1}{N}\log_e\left(\frac{x(N-1)}{N-x}\right)$$

$$\Rightarrow e^{Nkt} = \frac{x(N-1)}{N-x}$$

$$\therefore (N-x)e^{Nkt} = x(N-1)$$

$$\therefore x = \frac{Ne^{Nkt}}{N-1 + e^{Nkt}} = \frac{N}{1 + (N-1)e^{-Nkt}}$$

We notice that finding the solution of applied problems is no different from finding particular solutions to a given differential equation. The difference being that the d.e. has been put into context. However, there lies our difficulty; what happens if we are not given the differential equation? In such cases, we need to formulate the differential equation first and then proceed as before.

EXAMPLE 24.16

A container is initially filled with 100 litres of a salt solution containing 50 kg of salt. Brine containing 2 kg of salt per litre runs into a tank at a rate of 6 litres/min, and runs out at a rate of 4 litres/min, assuming that the mixture is kept uniform by stirring. Set up a differential equation describing the relationship for the amount of salt in the container at any time t minutes.

Solution

Let $s(t)$ kg be the amount of salt in the container at any time t minutes.

Then, we have that the rate of change in the amount of salt in the container must be given by

$$\frac{ds}{dt} = \text{Rate of salt In} - \text{Rate of salt Out (per minute)}$$

$$\begin{aligned} \text{Amount in} &= 2\text{ kg/l} \times 6\text{ l/min} \\ &= 12\text{ kg/min} \end{aligned}$$

The 'Rate in' (per minute) is 12 kg/min, while

the 'Rate out' (per minute) is $\frac{4s}{100+2t}$ kg/min.

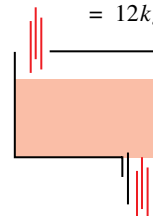

The last term is derived as follows:

First, we need to determine the concentration, C , of salt in the container at any time t . This is found using

$$C = \frac{\text{Amount of salt in container at any time } t}{\text{Volume of solution in container at any time } t}$$

$$\begin{aligned} \text{Amount out} &= \frac{s}{100+2t}\text{ kg/l} \times 4\text{ l/min} \\ &= \frac{4s}{100+2t}\text{ kg/min} \end{aligned}$$

And so we have, $C = \frac{s}{100 + (6-4)t}$, this is because

- by definition, we have that s kg is the amount of salt in the tank at any time t ,
- initially there are 100 litres of solution in the container and every minute this increases by $(6-4) = 2$ litres, so that after t minutes, there will be an extra $2t$ litres in the container.

Therefore, we have the differential equation, $\frac{ds}{dt} = 12 - \frac{4s}{100+2t}$, $t \geq 0$ or $\frac{ds}{dt} + \frac{2s}{50+t} = 12$.

Note that to solve this d.e. requires a method beyond the scope of this course.

EXAMPLE 24.17

Newton's law of cooling states that the rate of cooling of a body varies as the difference in temperature between the body and its surroundings. A body is cooling in surroundings which are kept at a constant temperature of 20°C . If the temperature is initially 85°C and 10 minutes later is 65°C , find its temperature after a further 10 minutes.

S o l u t i o n

Our first task is to derive a differential equation for the given situation.

Let the temperature of the body at any time t minutes, $t \geq 0$, after been placed in the surroundings, be $T^\circ\text{C}$.

From the given description we have that $\frac{dT}{dt} \propto (T-20) \Leftrightarrow \frac{dT}{dt} = k(T-20)$.

The initial conditions are, $t = 0, T = 85$ and $t = 10, T = 65$

From the d.e. we have $\frac{dT}{dt} = k(T-20) \Leftrightarrow \frac{1}{T-20} \frac{dT}{dt} = k$

$$\therefore \int \frac{1}{T-20} \frac{dT}{dt} dt = \int k dt$$

$$\Rightarrow \ln(T-20) = kt + c$$

Now, $t = 0, T = 85$ so that $\ln(65) = c$ and $t = 10, T = 65$ so that $\ln(45) = 10k + c$.

But, $c = \ln(65) \therefore \ln(45) = 10k + \ln(65) \Leftrightarrow k = \frac{1}{10} \ln\left(\frac{45}{65}\right) = \frac{1}{10} \ln\left(\frac{9}{13}\right)$.

So, $\ln(T-20) = \frac{1}{10} \ln\left(\frac{9}{13}\right)t + \ln(65)$.

After a further 10 minutes, $t = 20$, $\therefore \ln(T-20) = \frac{1}{10} \ln\left(\frac{9}{13}\right) \times 20 + \ln(65)$

$$\ln(T-20) = \ln\left(\frac{81}{169} \times 65\right)$$

$$\therefore T-20 = \frac{81}{169} \times 65$$

$$\therefore T = \frac{81}{169} \times 65 + 20 \approx 51.2$$

EXAMPLE 24.18

An inverted conical tank, full of water, has a plug in a small hole at its vertex. When the plug is removed, water flows out of the hole at a rate proportional to the square root of the level of the water in the tank. Initially the depth of water in the tank is 7.84 m and 2 minutes later it is 3.61 m. How long will it take for the tank to empty?

S
O
L
I
T
I
O
N

Let the volume of water in the tank, at a depth of h m be V m³ (once the plug is removed from the hole at the apex).

Then, we have that $\frac{dV}{dt} \propto \sqrt{h} \Leftrightarrow \frac{dV}{dt} = -k\sqrt{h}, k > 0$.

This time we have a d.e. involving three variables, t, V and h .

We need to obtain a differential involving V and h , so, using the

chain rule we have $\frac{dV}{dt} = \frac{dV}{dh} \cdot \frac{dh}{dt}$, giving $-k\sqrt{h} = \frac{dV}{dh} \cdot \frac{dh}{dt}$

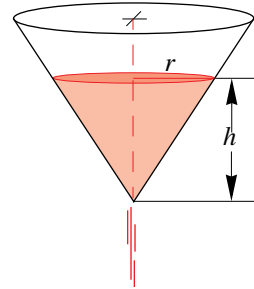

Next, we need an expression for V in terms of h .

Volume of a cone is $V = \frac{1}{3}\pi r^2 h$, but, from our diagram, $\frac{r}{h} = \text{constant} = m$ (say). So, $r = mh$.

Therefore, $V = \frac{1}{3}\pi(mh)^2 h = \frac{1}{3}\pi m^2 h^3 = ah^3$. i.e., we let $a = \frac{1}{3}\pi m^2 = \text{constant}$.

This means that $\frac{dV}{dh} = 3ah^2 \Rightarrow -k\sqrt{h} = 3ah^2 \cdot \frac{dh}{dt}$ and so, the d.e. is given by $\frac{dh}{dt} = \frac{-k\sqrt{h}}{3ah^2}$ or

$$\frac{dh}{dt} = -Ah^{-3/2}, \text{ where } A = \frac{k}{3a} = \text{constant}$$

We are now in a position to solve this d.e.:

$$\begin{aligned} \frac{dh}{dt} &= -Ah^{-3/2} \Leftrightarrow h^{3/2} \frac{dh}{dt} = -A \\ &\Rightarrow \int h^{3/2} \frac{dh}{dt} dt = -A \int dt \\ &\therefore \frac{2}{5} h^{5/2} = -At + c \end{aligned}$$

Now, $t = 0, h = 7.84$ so $\frac{2}{5}(7.84)^{5/2} = 0 + c \therefore c = 0.4(2.8)^5$. Giving $\frac{2}{5}h^{5/2} = -At + 0.4(2.8)^5$.

Next, $t = 2, h = 3.61$ and so, $\frac{2}{5}(1.9)^5 = -2A + 0.4(2.8)^5 \therefore A = 0.2(2.8)^5 - 0.2(1.9)^5$.

This means we have the equation $\frac{2}{5}h^{5/2} = -0.2[(2.8)^5 - (1.9)^5]t + 0.4(2.8)^5$.

Tank will be empty when $h = 0$, i.e., $0 = -0.2[(2.8)^5 - (1.9)^5]t + 0.4(2.8)^5$

$$\therefore t = \frac{0.4(2.8)^5}{0.2[(2.8)^5 - (1.9)^5]} \approx 2.34$$

That is it takes 2.34 minutes for the tank to empty.

EXERCISES 24.3

1. Radium decomposes at a rate that is proportional to the amount present at any time t years. Let there be R_0 gm of radium initially. If 10% of the substance decays in 200 years, how much, in terms of R_0 , will there be after 800 years?
2. The rate of decay of a radioactive substance is proportional to the amount of substance present at any time t years. It takes 1200 years for 50% of the substance to decay. How much of the substance will there be after 2000 years?
3. The population of a bacterial culture increases at a rate that is proportional to the number of bacteria present at any time t days. It takes 8 days for the population to double. If N is the number of bacteria present at any time t days, set up a differential equation for the rate of change of N . By solving this d.e., how long will it take for the population to treble?
4. Light penetrates a 10 cm thick slab of glass. The rate of loss of intensity with respect to the depth reached by the light is proportional to the intensity at that depth, I . If light loses 10 percent of its intensity after penetrating 20 percent of the slab, what percentage is lost after penetrating the slab?
5. The number of bacteria present in a culture increases at a rate proportional to the number of bacteria present at any time t hours. If the number of bacteria increases by 10% in one hour, what percentage increase will there be after a further four hours?
6. The rate of change of the volume of water, V litres, with respect to its level, h cm, in a container, is described by the differential equation $\frac{dV}{dh} = k\sqrt{V}$.
Given that 1 litre of water reaches a level of 9 cm and that 4 litres of water reaches a level of 13 cm, show that $V = \frac{1}{16}(h - 5)^2$.
7. A curve has a gradient function defined by the differential equation $\frac{dy}{dx} = \frac{x}{1 + x^2}$. Given that the curve passes through the point whose coordinates are $(1, \log_e \sqrt{2})$, find the equation of this curve.
8. The number of bacteria present in a culture, N , increases at a rate proportional to the number present in the culture, i.e., $\frac{dN}{dt} \propto N \Leftrightarrow \frac{dN}{dt} = kN$.
Initially there are 2000 bacteria present, which increase to 2200 after one hour. How many bacteria will there be in another 3 hours?
9. A raindrop has its acceleration modelled by the differential equation $\frac{dv}{dt} = 9.8 - \frac{1}{4}v$, where v m/sec is its speed t sec after formation.
Find the equation for the speed of the raindrop t seconds after formation and hence, deduce its limiting speed.

MATHEMATICS – Higher Level (Core)

- 10.** Water flowing out of a hole at the bottom of a cylindrical container is described by the differential equation $\frac{dV}{dt} = k\sqrt{h}$, where V is the volume of water remaining in the container.
- (a) Show that the relationship between the height, h cm, of volume of water remaining in the container and the time, t minutes, for which water has been flowing out is given by the differential equation $\frac{dh}{dt} = \frac{k}{\pi r^2}\sqrt{h}$.
- Hint: Use the chain rule.
- (b) Initially the container, of height 25 cm is full of water. Find how long it will take for the container to empty if, after 1 minute, the level is 9cm.
- 11.** A chemical reaction is such that the speed of the reaction, $\frac{dx}{dt}$, for an amount of substance, x kg, present at any time t is defined by the differential equation $\frac{dx}{dt} = k(10 - x)(30 - x)$, where k is a real constant. Given that $x(0) = 0$ and $x(1) = 2$, find t when $x = 5$.
- 12.** Newton's law of cooling states that the rate of change of cooling of a body is proportional to the difference in temperature between the body and its surroundings. An object with a temperature of 60°C cools to a temperature of 50°C in 8 minutes, when placed in a room whose temperature is kept at a constant 20°C . What will the object's temperature be in another 8 minutes?
- 13.** A large tank holds 100 litres of brine which is made up with 80 kg of salt. A second solution is run into the tank at a rate of 10 litres/min. The mixture is kept uniform by constantly stirring and is allowed to flow out at the same rate. Set up and solve, the differential equation for the amount of salt present in the tank at any time t , $t \geq 0$, for each of the following cases:
- (a) i. If the second solution is fresh water.
ii. If the second solution has a concentration of 1kg/litre.
- Now consider the case where the solution is flowing out at a rate of 8 litres/min. Set up and solve, the differential equation for the amount of salt present in the tank at any time t , $t \geq 0$, for each of the following cases:
- (b) i. If the second solution is fresh water.
ii. If the second solution has a concentration of 1kg/litre.
- 14.** The rate at which a chemical reaction creates a new substance y , is proportional to the product of the differences $(M - y)$ and $(N - y)$. By setting up a differential equation, show that $y = \frac{Mke^{c(N-M)t} - N}{ke^{c(N-M)t} - 1}$, where k and c are real constants.
- 15.** An economic model for the National Debt of a country has been suggested to follow the related differential equations $\frac{dD}{dt} = k_1I$ and $\frac{dI}{dt} = k_2I$, where I dollars is the national income and D dollars the national debt. When the model is put into place, the country has a national income of $\$I_0$ and a national debt of $\$D_0$.

- (a) Show that $D = \frac{k_1}{k_2} I_0 (e^{k_2 t} - 1) + D_0$
- (b) What does this model predict will happen over a long time frame.

- 16.** The differential equation describing the motion of a parachutist, of mass m kg travelling downwards with an initial speed u , and subjected to air resistance that is proportional to her current speed, v , is given by $m \frac{dv}{dt} + kv = mg$, where g m/s² is her acceleration due to gravity.

(a) Show that $v = \frac{mg}{k} \left(1 - e^{-\frac{k}{m}t} \right) + ue^{-\frac{k}{m}t}$, $t \geq 0$

- (b) Investigate the following situations;

i. $u > \frac{mg}{k}$ ii. $u < \frac{mg}{k}$ iii. $u = \frac{mg}{k}$,

sketching a graph for each case.

- 17.** The rate of decrease of the intensity I with respect to the depth, x m, of a beam of light passing through water that has been treated with a chemical, is found to be proportional to the intensity at that depth. If the intensity of light at the surface is I_0 and the constant of proportionality (i.e., the absorption coefficient) is given by $\alpha e^{-\beta x}$, find an expression for the intensity of light at any depth x units.

- 18.** The charge Q on a charging capacitor in an RC circuit with constant voltage V is given by the differential equation

$$R \frac{dQ}{dt} + \frac{Q}{C} = V,$$

where $Q(0) = 0$. Find $Q(t)$.

- 19.** The harvesting of fish from a lake, is being carried out at a constant rate r . If $N(t)$, is the population size of fish in the lake, we have that an appropriate model for the harvesting process is given by the differential equation

$$\frac{dN}{dt} = k_1 N - k_2 N^2 - r, \quad N(t_0) = N_0.$$

Solve this differential equation and investigate the four cases;

i. $r = 0$ ii. $r < \frac{k_1^2}{4k_2}$ iii. $r = \frac{k_1^2}{4k_2}$ iv. $r > \frac{k_1^2}{4k_2}$.

How does the initial population size affect each of these cases?

- 20.** A solid sphere is completely immersed in acid and dissolves at a rate directly proportional to its surface area, A cm². After m minutes the volume is reduced by half. How long will it take to completely dissolve the sphere?

25.1 INTRODUCTION TO MATRICES

25.1.1 DEFINITIONS

1. Matrix

Matrices are in many senses similar to vectors except that whilst vectors are represented by columns of numbers, matrices are generally blocks of numbers made up of a number of **rows** and **columns**. In their simplest form, matrices are often used to store information.

Consider the following family shopping list:

	Mon	Tues	Wed	Thurs	Fri	Sat	Sun
Bread (loaf)	1	1	0	0	0	2	0
Milk (litre)	3	1	3	2	0	5	1
Eggs	6	6	0	0	6	6	0
Butter (100g)	2	0	1	0	0	3	1

If the family always makes the list in this way, that is beginning with Monday as far as the columns are concerned, and always recording the produce items in the same rows, then the headings become unnecessary and the information can be stored as a **matrix** (plural - matrices):

$$\begin{bmatrix} 1 & 1 & 0 & 0 & 2 & 0 \\ 3 & 1 & 3 & 2 & 0 & 5 & 1 \\ 6 & 6 & 0 & 0 & 6 & 6 & 0 \\ 2 & 0 & 1 & 0 & 0 & 3 & 1 \end{bmatrix}$$

This matrix has four **rows** and seven **columns** and is said to have an **order** of 4 by 7.

To enter this matrix on the TI-82/3, press the **MATRIX** key, select **EDIT** and matrix **[A]**.

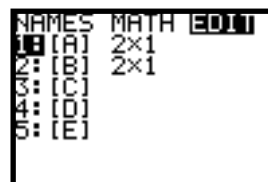

Next, enter the order of the matrix 4×7 , and then enter the values given in the table. You can move from position to position by using the arrow keys or **ENTER** key. The screen is not large enough to display all the entries of this matrix. The other entries will 'scroll' into view when you use the right arrow.

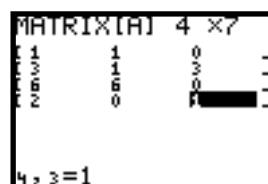

Once the information has been stored in the matrix memory it can only be accessed using the **MATRIX**, **NAMES** submenu.

It is also useful to remember that spreadsheets are ideally suited to handle information in matrix form. Spreadsheets can generally handle larger matrices and do more with them, but you need a computer and these are not allowed in the exams (yet!).

MATHEMATICS – Higher Level (Core)

2. Equal Matrices

Two matrices are said to be equal iff

1. they have the same dimensions.
2. corresponding elements are equal.

$$\text{e.g., } \begin{bmatrix} 1 & 4 \\ 2 & 5 \\ 6 & x \end{bmatrix} = \begin{bmatrix} 1 & 4 \\ y & 5 \\ 6 & 7 \end{bmatrix} \text{ iff } x = 7 \text{ and } y = 2;$$

$$\begin{bmatrix} 1 & 5 \\ 2 & 9 \end{bmatrix} \neq \begin{bmatrix} 1 & 5 \\ 2 & 9 \\ 0 & 0 \end{bmatrix} \text{ as they have different orders. } \begin{bmatrix} 1 & 5 \\ 2 & 9 \end{bmatrix} \text{ has order } 2 \times 2, \begin{bmatrix} 1 & 5 \\ 2 & 9 \\ 0 & 0 \end{bmatrix} \text{ has order } 3 \times 2$$

3. Addition of Matrices

Two matrices A and B can only be added if they have of the same order. Then, they can be added by adding corresponding elements.

$$\text{e.g., } \begin{bmatrix} 1 & 2 & 3 \\ 4 & 5 & 6 \end{bmatrix} + \begin{bmatrix} 3 & -4 & 3 \\ 2 & 8 & -1 \end{bmatrix} = \begin{bmatrix} 1+3 & 2-4 & 3+3 \\ 4+2 & 5+8 & 6-1 \end{bmatrix} = \begin{bmatrix} 4 & -2 & 6 \\ 6 & 13 & 5 \end{bmatrix};$$

$$\begin{bmatrix} 2 & 5 \\ 7 & 1 \end{bmatrix} + \begin{bmatrix} -4 & 3 & 8 \\ 2 & 9 & 4 \end{bmatrix} \text{ cannot be added as they are of different order.}$$

4. Scalar multiplication

If A is any matrix, then kA , where k is a real number, is a new matrix for which each element of A has been multiplied by k .

$$\text{e.g., } 3 \begin{bmatrix} 2 & 4 \\ -1 & 5 \end{bmatrix} = \begin{bmatrix} 3 \times 2 & 3 \times 4 \\ 3 \times -1 & 3 \times 5 \end{bmatrix} = \begin{bmatrix} 6 & 12 \\ -3 & 15 \end{bmatrix};$$

$$-\frac{1}{2} \begin{bmatrix} 4 & 8 & 10 \\ 6 & -4 & -2 \end{bmatrix} = \begin{bmatrix} -2 & -4 & -5 \\ -3 & 2 & 1 \end{bmatrix}$$

5. Subtraction of Matrices

The difference, $A - B$ of two matrices A and B (of the same order) may be defined as $A + (-B)$. So, the difference, $A - B$, is a new matrix whose elements are the differences between corresponding elements of A and B .

$$\text{e.g., } \begin{bmatrix} 4 & 6 \\ 2 & -8 \\ 1 & 0 \end{bmatrix} - \begin{bmatrix} 2 & 1 \\ 5 & 3 \\ -2 & 4 \end{bmatrix} = \begin{bmatrix} 4-2 & 6-1 \\ 2-5 & -8-3 \\ 1-(-2) & 0-4 \end{bmatrix} = \begin{bmatrix} 2 & 5 \\ -3 & -11 \\ 3 & -4 \end{bmatrix}$$

6. Square Matrix

A square matrix is a matrix with the same number of rows as columns, so that an $n \times n$ matrix is a square matrix of order n .

e.g., $\begin{bmatrix} 2 & -3 \\ 4 & 6 \end{bmatrix}$ is a square matrix of order 2; $\begin{bmatrix} 1 & 4 & 0 \\ -3 & 2 & 1 \\ 0 & -2 & -1 \end{bmatrix}$ is a square matrix of order 3.

7. Zero Matrix

A matrix with every element equal to zero is called a zero matrix. A zero matrix can have any dimension and is usually written as O .

e.g., each of the following are zero matrices; $\begin{bmatrix} 0 & 0 \end{bmatrix}$; $\begin{bmatrix} 0 & 0 \\ 0 & 0 \end{bmatrix}$; $\begin{bmatrix} 0 & 0 \\ 0 & 0 \\ 0 & 0 \end{bmatrix}$.

8. Additive Identity Matrix

For any matrix A , the zero matrix O (having the same order as A) is the additive identity of A . i.e.,

$$A + O = A = O + A$$

9. Additive Inverse

The additive inverse of a matrix A is the matrix $-A$.

This can be seen from the result that $A + (-A) = O = (-A) + A$.

EXAMPLE 25.1

Three matrices are defined as follows:

$$A = \begin{bmatrix} 2 & 3 & -4 \\ 1 & 0 & -2 \end{bmatrix} \quad B = \begin{bmatrix} 2 & 1 \\ 5 & 3 \\ 4 & 5 \end{bmatrix} \quad C = \begin{bmatrix} -1 & 3 & 0 \\ -3 & -1 & 6 \end{bmatrix}$$

Evaluate: (a) $2B$ (b) $-3C$ (c) $A + C$
 (d) $A + B$ (e) $2A + 3C$ (f) $3A - 4C$

S
o
l
u
t
i
o
n

$$(a) \quad 2B = 2 \times \begin{bmatrix} 2 & 1 \\ 5 & 3 \\ 4 & 5 \end{bmatrix} = \begin{bmatrix} 4 & 2 \\ 10 & 6 \\ 8 & 10 \end{bmatrix}$$

$$(b) \quad -3C = -3 \times \begin{bmatrix} -1 & 3 & 0 \\ -3 & -1 & 6 \end{bmatrix} = \begin{bmatrix} 3 & -9 & 0 \\ 9 & 3 & -18 \end{bmatrix}$$

$$(c) \quad \begin{bmatrix} 2 & 3 & -4 \\ 1 & 0 & -2 \end{bmatrix} + \begin{bmatrix} -1 & 3 & 0 \\ -3 & -1 & 6 \end{bmatrix} = \begin{bmatrix} 2-1 & 3+3 & -4+0 \\ 1-3 & 0-1 & -2+6 \end{bmatrix} = \begin{bmatrix} 1 & 6 & -4 \\ -2 & -1 & 4 \end{bmatrix}$$

MATHEMATICS – Higher Level (Core)

(d) $A + B$ cannot be calculated as the matrices are of different order.

$$\begin{aligned} \text{(e)} \quad 2A + 3C &= 2 \times \begin{bmatrix} 2 & 3 & -4 \\ 1 & 0 & -2 \end{bmatrix} + 3 \times \begin{bmatrix} -1 & 3 & 0 \\ -3 & -1 & 6 \end{bmatrix} \\ &= \begin{bmatrix} 4 & 6 & -8 \\ 2 & 0 & -4 \end{bmatrix} + \begin{bmatrix} -3 & 9 & 0 \\ -9 & -3 & 18 \end{bmatrix} \\ &= \begin{bmatrix} 1 & 15 & -8 \\ -7 & -3 & 14 \end{bmatrix} \end{aligned}$$

$$\begin{aligned} \text{(f)} \quad 3A - 4C &= 3 \times \begin{bmatrix} 2 & 3 & -4 \\ 1 & 0 & -2 \end{bmatrix} - 4 \times \begin{bmatrix} -1 & 3 & 0 \\ -3 & -1 & 6 \end{bmatrix} \\ &= \begin{bmatrix} 6 & 9 & -12 \\ 3 & 0 & -6 \end{bmatrix} - \begin{bmatrix} -4 & 12 & 0 \\ -12 & -4 & 24 \end{bmatrix} \\ &= \begin{bmatrix} 10 & -3 & -12 \\ 15 & 4 & -30 \end{bmatrix} \end{aligned}$$

As a second example we look at the matrix of the family shopping list that was introduced at the start of this chapter.

If a second family makes a shopping list using the same row and column headings, they will also store their information in a matrix of order 4 by 7. Suppose that this second family want to buy the items indicated in this second matrix.

$$\begin{bmatrix} 1 & 1 & 2 & 0 & 0 & 2 & 0 \\ 3 & 0 & 1 & 2 & 0 & 5 & 1 \\ 6 & 2 & 0 & 1 & 2 & 6 & 0 \\ 2 & 1 & 1 & 0 & 1 & 3 & 1 \end{bmatrix}$$

If the two families wanted to place a single order, they would add the two matrices together. In this application, it would only make sense to add corresponding entries (top left to top left etc).

$$\begin{aligned} \begin{bmatrix} 1 & 1 & 0 & 0 & 0 & 2 & 0 \\ 3 & 1 & 3 & 2 & 0 & 5 & 1 \\ 6 & 6 & 0 & 0 & 6 & 6 & 0 \\ 2 & 0 & 1 & 0 & 0 & 3 & 1 \end{bmatrix} + \begin{bmatrix} 1 & 1 & 2 & 0 & 0 & 2 & 0 \\ 3 & 0 & 1 & 2 & 0 & 5 & 1 \\ 6 & 2 & 0 & 1 & 2 & 6 & 0 \\ 2 & 1 & 1 & 0 & 1 & 3 & 1 \end{bmatrix} &= \begin{bmatrix} 1+1 & 1+1 & 0+2 & 0+0 & 0+0 & 2+2 & 0+0 \\ 3+3 & 1+0 & 3+1 & 2+2 & 0+0 & 5+5 & 1+1 \\ 6+6 & 6+2 & 0+0 & 0+1 & 6+2 & 6+6 & 0+0 \\ 2+2 & 0+1 & 1+1 & 0+0 & 0+1 & 3+3 & 1+1 \end{bmatrix} \\ &= \begin{bmatrix} 2 & 2 & 2 & 0 & 0 & 4 & 0 \\ 6 & 1 & 4 & 4 & 0 & 10 & 2 \\ 12 & 8 & 0 & 1 & 8 & 12 & 0 \\ 4 & 1 & 2 & 0 & 1 & 6 & 2 \end{bmatrix} \end{aligned}$$

EXAMPLE 25.2

Find x , y and z if $A = B$, where $A = \begin{bmatrix} 2x & y+1 \\ 5 & 9 \end{bmatrix}$, $B = \begin{bmatrix} x^2+1 & 3 \\ 3z-4 & z^2 \end{bmatrix}$

If $A = B$ then $\begin{bmatrix} 2x & y+1 \\ 5 & 9 \end{bmatrix} = \begin{bmatrix} x^2+1 & 3 \\ 3z-4 & z^2 \end{bmatrix} \Leftrightarrow 2x = x^2+1, y+1 = 3, 5 = 3z-4, z^2 = 9$

Now, $2x = x^2+1 \Leftrightarrow x^2-2x+1 = 0 \Leftrightarrow (x-1)^2 = 0 \therefore x = 1$ – (1)

$y+1 = 3 \Leftrightarrow y = 2$ – (2)

$5 = 3z-4 \Leftrightarrow 9 = 3z \Leftrightarrow z = 3$ – (3)

$z^2 = 9 \Leftrightarrow z = \pm 3$ – (4)

From (3) and (4) we conclude that $z = 3$. Therefore, we have that $x = 1, y = 2$ and $z = 3$.

EXERCISES 25.1.1

1. Two matrices are defined as: $P = \begin{bmatrix} 1 & 4 \\ -1 & 8 \end{bmatrix}, Q = \begin{bmatrix} 2 & -3 \\ -1 & 5 \end{bmatrix}$, evaluate:

- (i) $2P$ (ii) $-Q$ (iii) $3Q$
 (iv) $2P + Q$ (v) $3P + 2Q$ (vi) $Q - 4P$

2. If $A = \begin{bmatrix} 1 & 1 & 2 \\ 0 & -6 & 9 \end{bmatrix}, B = \begin{bmatrix} 1 & 0 \\ 2 & 1 \\ 0 & -1 \end{bmatrix}, C = \begin{bmatrix} -3 & -5 \\ 0 & 1 \\ 3 & 2 \end{bmatrix}$, evaluate, where possible:

- (i) $-A$ (ii) $-2A$ (iii) $B + C$
 (iv) $2B$ (v) $2B - C$ (vi) $3(B + C)$

3. If $X = \begin{bmatrix} 1 & 1 & 2 \\ 0 & 1 & 4 \\ 0 & 2 & 1 \end{bmatrix}, Y = \begin{bmatrix} -1 & -2 & 3 \\ 2 & 0 & 1 \\ 2 & 0 & -4 \end{bmatrix}$, evaluate:

- (i) $3X$ (ii) $2Y$ (iii) $X + Y$
 (iv) $X - Y$ (v) $3X + 2Y$ (vi) $2Y - X$

4. The diagram shows a spreadsheet used to store the sales of a small shop.

	A	B	C	D	E	F	G	H	I	J	K	L	M
1	Week 1						Week 2						
2		Mon	Tues	Wed	Thurs	Fri			Mon	Tues	Wed	Thurs	Fri
3	Nuts	4	27	20	18	32		Nuts	45	4	44	4	53
4	Bolts	34	33	39	50	5		Bolts	11	10	10	48	8
5	Pegs	37	23	51	23	29		Pegs	23	10	39	51	9
6	Pins	0	48	45	10	23		Pins	36	22	44	5	38
7	Clips	49	21	55	17	25		Clips	53	17	56	28	11
8	Taps	53	10	49	9	49		Taps	8	16	33	47	26
9	Plugs	12	12	45	16	50		Plugs	46	33	0	25	9

MATHEMATICS – Higher Level (Core)

- (i) What was the number of sales of pins on Friday of Week 1?
- (ii) Which item sold least on Thursday of Week 2?
- (iii) Which item sold most on Monday of Week 1?
- (iv) On what day were there no sales of Plugs?

A place on the spreadsheet at which the total sales in the two weeks will be calculated by formula is needed. What formula should be used to calculate the Monday sales of nuts? If this is copied to the cell immediately below, what will the formula read?

- 5.** A stock control system stores the stocks of seven different products as the rows of a matrix. The company works a five day week and records the closing stocks as the columns of a matrix.
What is the order of the matrix?

6. If $A = \begin{bmatrix} a & 1 \\ -1 & -a \end{bmatrix}$, $B = \begin{bmatrix} 2a & 2 \\ 1 & a \end{bmatrix}$, express $A + B$ as a matrix.

- 7.** The zero matrix has entries that are all zero. Find the value(s) of a such that $P + Q$ is the zero matrix. $P = \begin{bmatrix} a & 2 \\ 5 & -3 \end{bmatrix}$, $Q = \begin{bmatrix} -3 & a-5 \\ -5 & a \end{bmatrix}$.

- 8.** A diagonal matrix has all zero elements except for those on the top left to bottom right diagonal. Find the values of a such that the matrix $A + B$ is diagonal where:

$$A = \begin{bmatrix} 5 & 1 & a \\ 3 & 7 & -4 \\ -2 & a+2 & 2 \end{bmatrix} \quad B = \begin{bmatrix} 3 & -1 & -2 \\ -3 & -2 & 2a \\ 2 & -4 & 3 \end{bmatrix}$$

9. If $A = \begin{bmatrix} \sin^2\theta & 0 \\ 0 & \cos^2\theta \end{bmatrix}$ and $B = \begin{bmatrix} \cos^2\theta & 0 \\ 0 & \sin^2\theta \end{bmatrix}$ simplify

(a) $A + B$ (b) $A - B$ (c) $2A - \begin{bmatrix} 1 & 0 \\ 0 & 1 \end{bmatrix}$ (d) $A + B - \begin{bmatrix} 1 & 0 \\ 0 & 1 \end{bmatrix}$

10. If $A = \begin{bmatrix} \sin^2\theta & \sin\theta \\ -\cos\theta & \cos^2\theta \end{bmatrix}$ and $B = \begin{bmatrix} \cos^2\theta & -\sin\theta \\ \cos\theta & \sin^2\theta \end{bmatrix}$ simplify

(a) $A + B$ (b) $A - B$

11. Find a and b if $aA + B = A$ where $A = \begin{bmatrix} 2 & 5 \\ -3 & 4 \end{bmatrix}$ and $B = \begin{bmatrix} -b & -10 \\ 6 & -2b \end{bmatrix}$.

12. Find x if $x^2 \begin{bmatrix} 1 & -1 \\ 2 & 1 \end{bmatrix} + x \begin{bmatrix} 2 & 4 \\ 1 & -6 \end{bmatrix} + \begin{bmatrix} 3 & 1 \\ 4 & 5 \end{bmatrix} = \begin{bmatrix} 6 & 4 \\ 7 & 0 \end{bmatrix}$.

25.1.2 MATRIX MULTIPLICATION

Matrix multiplication has a special definition that was developed because it appears to be the most practical. This definition can be useful in business applications, solving simultaneous equations and in transformation geometry. This last application has helped in the development of one of the newest branches of mathematics, fractal geometry.

The definition involves taking the rows of the left hand matrix and pairing these with the columns of the second matrix. If the problem is to find the product:

$$\begin{bmatrix} 2 & 5 & 0 \\ 1 & 0 & -2 \\ 1 & -3 & 1 \end{bmatrix} \times \begin{bmatrix} 1 & 3 & -1 \\ 0 & 2 & 0 \\ 1 & -3 & 1 \end{bmatrix}$$

The first step is to take the first row of the left hand matrix [2 5 0], write it as a column and pair it up with the first column of the 2nd matrix. The pairs are then multiplied and the products totalled to give a single number, in this case, '2'.

$$\begin{aligned} 2 \times 1 &= 2 \\ 5 \times 0 &= 0 \\ 0 \times 1 &= 0 \\ \hline &2 \end{aligned}$$

This number is the result of combining the first row and the first column. It becomes the element in the first row and first column of the answer. The calculation must be completed for all the combinations of rows and columns. The nine calculations are:

$$\begin{bmatrix} 2 & 5 & 0 \\ 1 & 0 & -2 \\ 1 & -3 & 1 \end{bmatrix} \times \begin{bmatrix} 1 & 3 & -1 \\ 0 & 2 & 0 \\ 1 & -3 & 1 \end{bmatrix} : \begin{bmatrix} 2 & 5 & 0 \\ 1 & 0 & -2 \\ 1 & -3 & 1 \end{bmatrix} \times \begin{bmatrix} 1 & 3 & -1 \\ 0 & 2 & 0 \\ 1 & -3 & 1 \end{bmatrix} : \begin{bmatrix} 2 & 5 & 0 \\ 1 & 0 & -2 \\ 1 & -3 & 1 \end{bmatrix} \times \begin{bmatrix} 1 & 3 & -1 \\ 0 & 2 & 0 \\ 1 & -3 & 1 \end{bmatrix}$$

$$\begin{aligned} 2 \times 1 &= 2 & 2 \times 3 &= 6 & 2 \times -1 &= -2 \\ 5 \times 0 &= 0 & 5 \times 2 &= 10 & 5 \times 0 &= 0 \\ 0 \times 1 &= 0 & 0 \times -3 &= 0 & 0 \times 1 &= 0 \\ \hline &2 & \hline &16 & \hline &-2 \end{aligned}$$

$$\begin{bmatrix} 2 & 5 & 0 \\ 1 & 0 & -2 \\ 1 & -3 & 1 \end{bmatrix} \times \begin{bmatrix} 1 & 3 & -1 \\ 0 & 2 & 0 \\ 1 & -3 & 1 \end{bmatrix} : \begin{bmatrix} 2 & 5 & 0 \\ 1 & 0 & -2 \\ 1 & -3 & 1 \end{bmatrix} \times \begin{bmatrix} 1 & 3 & -1 \\ 0 & 2 & 0 \\ 1 & -3 & 1 \end{bmatrix} : \begin{bmatrix} 2 & 5 & 0 \\ 1 & 0 & -2 \\ 1 & -3 & 1 \end{bmatrix} \times \begin{bmatrix} 1 & 3 & -1 \\ 0 & 2 & 0 \\ 1 & -3 & 1 \end{bmatrix}$$

$$\begin{aligned} 1 \times 1 &= 1 & 1 \times 3 &= 3 & 1 \times -1 &= -1 \\ 0 \times 0 &= 0 & 0 \times 2 &= 0 & 0 \times 0 &= 0 \\ -2 \times 1 &= -2 & -2 \times -3 &= 6 & -2 \times 1 &= -2 \\ \hline &-1 & \hline &9 & \hline &-3 \end{aligned}$$

$$\begin{bmatrix} 2 & 5 & 0 \\ 1 & 0 & -2 \\ 1 & -3 & 1 \end{bmatrix} \times \begin{bmatrix} 1 & 3 & -1 \\ 0 & 2 & 0 \\ 1 & -3 & 1 \end{bmatrix} : \begin{bmatrix} 2 & 5 & 0 \\ 1 & 0 & -2 \\ 1 & -3 & 1 \end{bmatrix} \times \begin{bmatrix} 1 & 3 & -1 \\ 0 & 2 & 0 \\ 1 & -3 & 1 \end{bmatrix} : \begin{bmatrix} 2 & 5 & 0 \\ 1 & 0 & -2 \\ 1 & -3 & 1 \end{bmatrix} \times \begin{bmatrix} 1 & 3 & -1 \\ 0 & 2 & 0 \\ 1 & -3 & 1 \end{bmatrix}$$

$$\begin{aligned} 1 \times 1 &= 1 & 1 \times 3 &= 3 & 1 \times -1 &= -1 \\ -3 \times 0 &= 0 & -3 \times 2 &= -6 & -3 \times 0 &= 0 \\ 1 \times 1 &= 1 & 1 \times -3 &= -3 & 1 \times 1 &= 1 \\ \hline &2 & \hline &-6 & \hline &0 \end{aligned}$$

In matrix form, this answer is: $\begin{bmatrix} 2 & 16 & -2 \\ -1 & 9 & -3 \\ 2 & -6 & 0 \end{bmatrix}$

MATHEMATICS – Higher Level (Core)

It is not only square matrices that can be multiplied. All that is necessary is for the columns of the first matrix to match the number of rows in the second matrix. That is,

If A is a matrix of order $l \times m$ and B is a matrix of order $m \times n$, then their product is the matrix $C = AB$ of order $l \times n$. So that

$$\begin{array}{l} \text{matrix:} \quad A \times B = C \\ \text{order:} \quad (l \times m) \times (m \times n) = (l \times n) \end{array}$$

e.g., the following products are possible:

$$\begin{bmatrix} 2 & 4 & 7 \\ 1 & 5 & -2 \end{bmatrix} \begin{bmatrix} 1 & -2 \\ -4 & 5 \\ 1 & 6 \end{bmatrix} = \text{matrix of order } (2 \times 2)$$

$(2 \times 3) \times (3 \times 2)$

$$\begin{bmatrix} 4 & -5 & 10 & 6 \end{bmatrix} \begin{bmatrix} 3 & 1 \\ -5 & 2 \\ -11 & 3 \\ 9 & 4 \end{bmatrix} = \text{matrix of order } (1 \times 2)$$

$(1 \times 4) \times (4 \times 2)$

the following product is **not** possible:

$$\begin{bmatrix} -1 & 5 & 8 \\ 9 & 3 & 12 \end{bmatrix} \begin{bmatrix} 3 & 6 \\ 2 & 10 \end{bmatrix}$$

$(2 \times 3) \times (2 \times 2)$

Note: reversing the order in which the matrices in our example are multiplied does not yield the

same result. That is,

$$\begin{bmatrix} 1 & 3 & -1 \\ 0 & 2 & 0 \\ 1 & -3 & 1 \end{bmatrix} \begin{bmatrix} 2 & 5 & 0 \\ 1 & 0 & -2 \\ 1 & -3 & 1 \end{bmatrix} = \begin{bmatrix} 4 & 8 & -7 \\ 2 & 0 & -4 \\ 0 & 2 & 7 \end{bmatrix} \neq \begin{bmatrix} 2 & 16 & -2 \\ -1 & 9 & -3 \\ 2 & -6 & 0 \end{bmatrix}$$

This shows us that matrix multiplication is not commutative. This means that the order in which the matrices are multiplied does matter.

EXAMPLE 25.3

For the matrices: $A = \begin{bmatrix} 1 & 0 \\ 2 & 6 \end{bmatrix}$, $B = \begin{bmatrix} 2 & -1 & -1 \\ 2 & 0 & -3 \end{bmatrix}$, $C = \begin{bmatrix} 2 & -1 \\ -3 & 2 \\ 1 & 4 \end{bmatrix}$, calculate,

- where possible: (a) AB (b) BC (c) CA
 (d) BA (e) A^2 (f) ABC

Solution

(a) $AB = \begin{bmatrix} 1 & 0 \\ 2 & 6 \end{bmatrix} \begin{bmatrix} 2 & -1 & -1 \\ 2 & 0 & -3 \end{bmatrix} = \begin{bmatrix} 2 & -1 & -1 \\ 16 & -2 & -20 \end{bmatrix}$

Note, in this case, multiplying a 2 by 2 matrix into a 2 by 3 matrix produces a 2 by 3 matrix.

$$(b) \quad BC = \begin{bmatrix} 2 & -1 & -1 \\ 2 & 0 & -3 \end{bmatrix} \begin{bmatrix} 2 & -1 \\ -3 & 2 \\ 1 & 4 \end{bmatrix} = \begin{bmatrix} 6 & -8 \\ 1 & -14 \end{bmatrix}$$

$$(c) \quad CA = \begin{bmatrix} 2 & -1 \\ -3 & 2 \\ 1 & 4 \end{bmatrix} \begin{bmatrix} 1 & 0 \\ 2 & 6 \end{bmatrix} = \begin{bmatrix} 0 & -6 \\ 1 & 12 \\ 9 & 24 \end{bmatrix}$$

$$(d) \quad BA = \begin{bmatrix} 2 & -1 & -1 \\ 2 & 0 & -3 \end{bmatrix} \begin{bmatrix} 1 & 0 \\ 2 & 6 \end{bmatrix} \text{ cannot be calculated as the orders are not compatible.}$$

$$(e) \quad A^2 = \begin{bmatrix} 1 & 0 \\ 2 & 6 \end{bmatrix} \begin{bmatrix} 1 & 0 \\ 2 & 6 \end{bmatrix} = \begin{bmatrix} 1 & 0 \\ 14 & 36 \end{bmatrix}$$

$$(f) \quad ABC = \begin{bmatrix} 1 & 0 \\ 2 & 6 \end{bmatrix} \begin{bmatrix} 2 & -1 & -1 \\ 2 & 0 & -3 \\ 1 & 4 \end{bmatrix} = \begin{bmatrix} 1 & 0 \\ 2 & 6 \end{bmatrix} \begin{bmatrix} 6 & -8 \\ 1 & -14 \end{bmatrix} = \begin{bmatrix} 6 & -8 \\ 18 & -100 \end{bmatrix}$$

There are two ways of calculating this triple product. The second is:

$$ABC = \begin{bmatrix} 1 & 0 \\ 2 & 6 \end{bmatrix} \begin{bmatrix} 2 & -1 & -1 \\ 2 & 0 & -3 \\ 1 & 4 \end{bmatrix} = \begin{bmatrix} 2 & -1 & -1 \\ 16 & -2 & -20 \end{bmatrix} \begin{bmatrix} 2 & -1 \\ -3 & 2 \\ 1 & 4 \end{bmatrix} = \begin{bmatrix} 6 & -8 \\ 18 & -100 \end{bmatrix}$$

This second method involves multiplying the first two matrices at the start, getting an answer and then multiplying this into the third. The order of the matrices has not been altered, just the way in which they have been grouped. This is called the **associative property** of matrix multiplication

Laws of Matrix Multiplication

If the matrices A, B, C are conformable under multiplication and belong to the set of matrices, M (say), then

- | | | |
|----|-------------------------|---|
| 1. | as $AB \in M$, | i.e., closure holds in matrix multiplication. |
| 2. | $AB \neq BA$, | i.e., multiplication is not commutative |
| 3. | $(AB)C = A(BC)$ | i.e., multiplication is associative. |
| 4. | $A(B + C) = AB + AC$ | i.e., multiplication is distributive. |
| 5. | $AI = A = IA$ | i.e., there exists a multiplicative identity. |
| 6. | $AA^{-1} = I = A^{-1}A$ | i.e., there exists a multiplicative inverse. |

Note: Under multiplication, **the identity matrix, I, is a square matrix** with all of its elements zero except for those on its leading diagonal, where the elements are all one. Also, if a matrix has an inverse under multiplication, it must be a square matrix.

MATHEMATICS – Higher Level (Core)

Examples of the identity matrix under matrix multiplication are

$$I = \begin{bmatrix} 1 & 0 \\ 0 & 1 \end{bmatrix} \text{ (also written as } I_2 \text{);} \quad I = \begin{bmatrix} 1 & 0 & 0 \\ 0 & 1 & 0 \\ 0 & 0 & 1 \end{bmatrix} \text{ (also written as } I_3 \text{).}$$

Similarly, if the inverse of a matrix A exists, then A must first of all be a square matrix.

Using a Graphics Calculator

Matrices can be stored as described earlier in this chapter. The names can be recovered using the **MATRIX NAME** command. To calculate AB in the example discussed above, enter the correct matrices and then draw out the two names to produce the result.

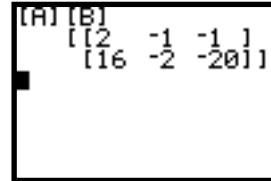

EXAMPLE 25.4

For the matrices: $A = \begin{bmatrix} 1 & 0 \\ 2 & 6 \end{bmatrix}$, $B = \begin{bmatrix} 2 & -1 & -1 \\ 2 & 0 & -3 \end{bmatrix}$, calculate, where possible:

- (a) AB (b) A^3 (c) B^2

S
o
l
u
t
i
o
n

We start by entering the data into the TI-83:



(a)

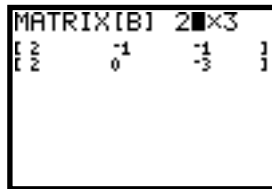

(b)

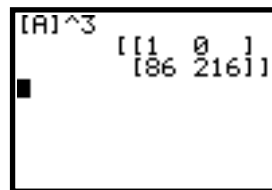
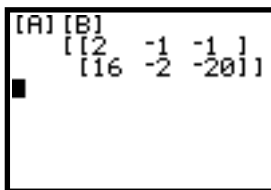

(c)

As B is not a square matrix, then B^2 cannot be evaluated.

EXERCISES 25.1.2

1. Evaluate the following matrix products:

(i) $\begin{bmatrix} 2 & 3 \\ -1 & 0 \end{bmatrix} \begin{bmatrix} -2 & 1 \\ 3 & -2 \end{bmatrix}$

(ii) $\begin{bmatrix} 2 & -2 \\ 1 & 5 \end{bmatrix} \begin{bmatrix} 0 & 1 \\ -3 & 5 \end{bmatrix}$

(iii) $\begin{bmatrix} -6 & 5 \\ 0 & 3 \end{bmatrix} \begin{bmatrix} 2 & -2 \\ 1 & 1 \end{bmatrix}$

(iv) $\begin{bmatrix} -2 & 3 \\ -5 & 2 \end{bmatrix} \begin{bmatrix} 0 & 8 \\ -5 & 2 \end{bmatrix}$

(v) $\begin{bmatrix} \frac{1}{3} & 7 \\ \frac{1}{2} & \frac{3}{4} \end{bmatrix} \begin{bmatrix} -1 & 5 \\ \frac{1}{2} & 4 \end{bmatrix}$

(vi) $\begin{bmatrix} 1.5 & 2 \\ 3 & -1.5 \end{bmatrix} \begin{bmatrix} -1.6 & 1 \\ 2.5 & 2 \end{bmatrix}$

$$\begin{array}{lll}
 \text{(vii)} \quad \begin{bmatrix} 4 & -2 \\ 0 & -3 \end{bmatrix} \begin{bmatrix} 2 & -1 & 1 \\ -2 & 0 & 1 \end{bmatrix} & \text{(viii)} \quad \begin{bmatrix} 5 & -1 \\ -2 & 0 \end{bmatrix} \begin{bmatrix} -2 & 1 & 1 \\ -1 & 2 & 3 \end{bmatrix} & \text{(ix)} \quad \begin{bmatrix} 1 & 2 \\ 4 & 7 \end{bmatrix} \begin{bmatrix} \frac{1}{2} & -\frac{1}{2} & 3 \\ \frac{1}{3} & 1 & -\frac{1}{3} \end{bmatrix} \\
 \\
 \text{(x)} \quad \begin{bmatrix} 2 & 1 \\ -3 & 0 \end{bmatrix} \begin{bmatrix} 1.3 & 1.4 & 1.9 \\ -1 & -3.5 & 0 \end{bmatrix} & \text{(xi)} \quad \begin{bmatrix} 1 & -2 & 0 \\ -2 & -3 & 1 \\ 3 & 0 & 1 \end{bmatrix} \begin{bmatrix} 1 & -2 \\ -5 & 0 \\ -2 & -1 \end{bmatrix} & \text{(xii)} \quad \begin{bmatrix} 1 & 6 & -1 \\ 2 & -3 & -9 \\ 1 & 2 & 0 \end{bmatrix} \begin{bmatrix} 6 & 2 \\ 0 & 1 \\ -1 & 3 \end{bmatrix} \\
 \\
 \text{(xiii)} \quad \begin{bmatrix} 1 & 0 & 2 \\ 2 & 1 & 0 \\ 3 & 0 & 1 \end{bmatrix} \begin{bmatrix} 6 & 0 & 2 \\ 0 & 1 & 0 \\ 3 & 3 & 0 \end{bmatrix} & \text{(xiv)} \quad \begin{bmatrix} -1 & 3 & -2 \\ 0 & -9 & 2 \\ -3 & -2 & 1 \end{bmatrix} \begin{bmatrix} 1 & -2 & -1 \\ 0 & 0 & 2 \\ 2 & -2 & 3 \end{bmatrix} \\
 \\
 \text{(xv)} \quad \begin{bmatrix} 1 & x & x \\ 2 & x & 2x \\ -x & 1 & 2 \end{bmatrix} \begin{bmatrix} x & 1 \\ x & -x \\ 2x & 0 \end{bmatrix} & \text{(xvi)} \quad \begin{bmatrix} a & 2x & -a \\ a & -2a & 0 \\ 0 & a & -x \end{bmatrix} \begin{bmatrix} 1 & 2 & 3 \\ x & 2 & -x \\ a & 0 & 1 \end{bmatrix}
 \end{array}$$

2. A matrix is defined by $M = \begin{bmatrix} -1 & 0 \\ 0 & -1 \end{bmatrix}$

- (i) Find M^2 (ii) Find M^3, M^4, M^5 (iii) Find a rule for M^n

3. The following information gives the numbers of journeys made by the delivery department of a small company:

From: → To ↓	A	B	C	D
A	0	3	4	2
B	1	0	0	6
C	1	2	0	2
D	4	3	0	0

The company has four different depots and the above table indicates that there was one journey made from depot A to depot B and three journeys made from B to A etc.

This second table gives the loading costs per load for goods leaving each depot.

Depot	Cost
A	\$120
B	\$105
C	\$110
D	\$100

It costs \$120 to load for one trip at depot A, \$105 to load for one trip at depot B, etc.

- (i) Write these two sets of information as matrices.
 (ii) Find the product of the two matrices.
 (iii) Explain the meaning of the entries in the product matrix.

4. Two matrices are defined as follows: $A = \begin{bmatrix} \frac{1}{2} & -\frac{\sqrt{3}}{2} \\ \frac{\sqrt{3}}{2} & \frac{1}{2} \end{bmatrix}$, $B = \begin{bmatrix} \frac{\sqrt{3}}{2} & -\frac{1}{2} \\ \frac{1}{2} & \frac{\sqrt{3}}{2} \end{bmatrix}$

Find the product AB and hence find a value of n such that $(AB)^n = \begin{bmatrix} 1 & 0 \\ 0 & 1 \end{bmatrix}$.

5. Find, where possible, the order of matrix A so that the following equations can be solved

(a) $\begin{bmatrix} a & b \\ c & d \end{bmatrix} A = \begin{bmatrix} x \\ y \end{bmatrix}$ (b) $A \begin{bmatrix} a & b \\ c & d \end{bmatrix} = \begin{bmatrix} x \\ y \end{bmatrix}$ (c) $\begin{bmatrix} a & b & c \end{bmatrix} A = \begin{bmatrix} x & y \end{bmatrix}$

(d) $\begin{bmatrix} a & b & c \end{bmatrix} A = \begin{bmatrix} m & n \\ x & y \\ u & v \end{bmatrix}$ (e) $A \begin{bmatrix} a & b & c \end{bmatrix} = \begin{bmatrix} m & n \\ x & y \\ u & v \end{bmatrix}$ (f) $\begin{bmatrix} a \\ b \\ c \end{bmatrix} A = \begin{bmatrix} x & y & z \\ k & l & m \\ n & o & p \end{bmatrix}$

6. (a) If $A = \begin{bmatrix} a & b \\ 1 & 1 \end{bmatrix}$ and $B = \begin{bmatrix} a & 1 \\ -b & 1 \end{bmatrix}$ does $(A - B)(A + B) = A^2 - B^2$?

(b) If $A = \begin{bmatrix} 1 & 0 \\ 0 & 1 \end{bmatrix}$ and $B = \begin{bmatrix} a & 1 \\ 1 & b \end{bmatrix}$ does $(A - B)(A + B) = A^2 - B^2$?

(c) What conditions must be placed on the matrices A and B so that $(A - B)(A + B) = A^2 - B^2$?

7. Find all possible matrices X which satisfy the equation $\begin{bmatrix} 5 & 4 \\ 10 & 8 \end{bmatrix} X = \begin{bmatrix} 12 \\ 24 \end{bmatrix}$

8. Find the real numbers a and b if $aX^2 + bX = 2I$ and $X = \begin{bmatrix} 2 & 1 \\ 1 & 3 \end{bmatrix}$.

9. Three divisions, A, B and C, of an animation studio are required to produce a certain amount of conceptual paintings, P, footage of film, F, and storyboards, S. The amounts produced by each division can be described using the following matrix:

	P	F	S
A	13	120	30
B	5	95	15
C	11	115	30

The cost of producing a conceptual painting is \$50. The profit made per footage of film is \$15 and the cost per storyboard is \$20.

Using a matrix method, which division is the most profitable?

- 10.** Let S be the matrix $\begin{bmatrix} -\sin\theta & \cos\theta \\ \cos\theta & \sin\theta \end{bmatrix}$ and T be the matrix $\begin{bmatrix} -\sin 2\theta & \cos 2\theta \\ \cos 2\theta & \sin 2\theta \end{bmatrix}$.
- (a) Find i. S^2 ii. S^3 .
- (b) Deduce i. S^{2n} ii. S^{2n+1} , where n is a natural number ≥ 1 .

(c) For what value(s) of θ will $\begin{bmatrix} -\sin\theta & \cos\theta \\ \cos\theta & \sin\theta \end{bmatrix} - \begin{bmatrix} -\sin 2\theta & \cos 2\theta \\ \cos 2\theta & \sin 2\theta \end{bmatrix} = O$?

- 11.** If $A = \begin{bmatrix} a & b \\ c & d \end{bmatrix}$, $b \neq 0$ and $B = \begin{bmatrix} w & x \\ y & z \end{bmatrix}$, find the conditions that the elements of B must satisfy so that the matrices A and B are commutative under matrix multiplication.

- 12.** If $AX = kX$, $k \in \mathbb{R}$ where $A = \begin{bmatrix} 4 & -2 \\ -2 & 4 \end{bmatrix}$, $X = \begin{bmatrix} x \\ y \end{bmatrix}$ and $x \neq 0 \neq y$, find k .

- 13.** Find the matrix A and express a , b and c in terms of p , if the system of equations

$$\begin{aligned} x + z &= 2p \\ x - y + p^2z &= p - 1 \\ px + y - (2p + 1)z &= p \end{aligned}$$

is expressed in the matrix form $A \begin{bmatrix} x \\ y \\ z \end{bmatrix} = \begin{bmatrix} a \\ b \\ c \end{bmatrix}$

- 14.** If $A = \begin{bmatrix} -2i & 1 \\ 1 & 2i \end{bmatrix}$, where $i^2 = -1$. Show that $A^2 + 4I = \begin{bmatrix} 1 & 0 \\ 0 & 0 \end{bmatrix}$.

- 15.** Given that $A = \begin{bmatrix} -3 \\ 2 \end{bmatrix}$, $X = \begin{bmatrix} x \\ y \end{bmatrix}$, $B = \begin{bmatrix} a & 6 \\ 6 & b \end{bmatrix}$ and $AX = B$, find x, y, a, b .

- 16.** For the matrices X and Y , show that if $XY = X$ and $YX = Y$ then $X^2 = X$.

- 17.** The Fibonacci numbers $0, 1, 1, 2, 3, 5, \dots$ are generated by the the recurrence relationship $F_{n+2} = F_{n+1} + F_n$, where $n \geq 0$ and F_n is the n th number such that $F_0 = 0, F_1 = 1$.

Given the matrix $A = \begin{bmatrix} 1 & 1 \\ 1 & 0 \end{bmatrix}$

- (a) find i. A^2 ii. A^3 iii. A^4
- (b) deduce an expression for A^n where $n \in \mathbb{Z}$.

25.2 INVERSES AND DETERMINANTS

25.2.1 INVERSE AND DETERMINANT OF 2 BY 2 MATRICES

Matrices with two rows and two columns can be manipulated and many useful calculations can be completed with them. We begin by providing some definitions.

1. The identity matrix

Recall, the **identity matrix**, I , is defined as the matrix such that $AI = A = IA$ for all square

matrices A . For 2 by 2 matrices, $I = \begin{bmatrix} 1 & 0 \\ 0 & 1 \end{bmatrix}$.

2. Determinant

The determinant of a 2 by 2 matrix is defined by $\det \begin{bmatrix} a & b \\ c & d \end{bmatrix} = ad - bc$ or $\begin{vmatrix} a & b \\ c & d \end{vmatrix} = ad - bc$.

The determinant is a scalar. If a matrix has a non-zero determinant, it is said to be non-singular, and if the **determinant is zero**, the matrix is said to be **singular**. We shall see that whether or not a matrix is singular is significant for some applications.

3. Inverse

The inverse of a square matrix A is written A^{-1} .

The product of a matrix and its inverse is the identity matrix, I , $AA^{-1} = A^{-1}A = I$. For 2 by 2 matrices, the inverse can be found by interchanging the top left and bottom right entries and changing the signs of the top right and bottom left entries. Finally, the inverse is found by dividing by the determinant. This can be done by dividing the matrix as a whole or by dividing each element separately. That is,

$$\text{If } A = \begin{bmatrix} a & b \\ c & d \end{bmatrix}, \text{ then, } A^{-1} = \begin{bmatrix} \frac{d}{ad-bc} & \frac{-b}{ad-bc} \\ \frac{-c}{ad-bc} & \frac{a}{ad-bc} \end{bmatrix} = \frac{1}{ad-bc} \begin{bmatrix} d & -b \\ -c & a \end{bmatrix}$$

Given that we need to divide by the determinant in order to find the inverse, if the determinant is zero we cannot divide and thus we cannot find the inverse. This implies that **a singular matrix has no inverse**.

PROOF

Let $A = \begin{bmatrix} a & b \\ c & d \end{bmatrix}$ and its inverse, $A^{-1} = \begin{bmatrix} u & v \\ x & y \end{bmatrix}$, then, if A^{-1} exists, we have $AA^{-1} = I = A^{-1}A$.

Using the L.H.S, we have, $\begin{bmatrix} a & b \\ c & d \end{bmatrix} \begin{bmatrix} u & v \\ x & y \end{bmatrix} = \begin{bmatrix} 1 & 0 \\ 0 & 1 \end{bmatrix} \Leftrightarrow \begin{bmatrix} au + bx & av + by \\ cu + dx & cv + dy \end{bmatrix} = \begin{bmatrix} 1 & 0 \\ 0 & 1 \end{bmatrix}$

That is, we have the system of equations:

$$\begin{array}{l} au + bx = 1 \quad av + by = 0 \\ cu + dx = 0 \quad cv + dy = 1 \end{array}$$

By solving these sets of equations simultaneously, we obtain;

$$u = \frac{d}{ad-bc}, v = -\frac{b}{ad-bc}, x = -\frac{c}{ad-bc}, y = \frac{a}{ad-bc}$$

or

$$u = \frac{d}{|A|}, v = -\frac{b}{|A|}, x = -\frac{c}{|A|}, y = \frac{a}{|A|}$$

That is, If $A = \begin{bmatrix} a & b \\ c & d \end{bmatrix}$ then $A^{-1} = \begin{bmatrix} \frac{d}{ad-bc} & -\frac{b}{ad-bc} \\ -\frac{c}{ad-bc} & \frac{a}{ad-bc} \end{bmatrix} = \frac{1}{ad-bc} \begin{bmatrix} d & -b \\ -c & a \end{bmatrix} = \frac{1}{|A|} \begin{bmatrix} d & -b \\ -c & a \end{bmatrix}$

Of course, this only works if A^{-1} exists, i.e., if $|A| = ad - bc \neq 0$.

EXAMPLE 25.5

Find the determinant and, where possible, the inverses of these matrices:

(a) $\begin{bmatrix} 2 & 1 \\ 5 & 3 \end{bmatrix}$ (b) $\begin{bmatrix} -3 & 2 \\ 0 & -1 \end{bmatrix}$ (c) $\begin{bmatrix} 2 & 6 \\ 1 & 3 \end{bmatrix}$

S
o
l
u
t
i
o
n

(a) $\det \begin{bmatrix} 2 & 1 \\ 5 & 3 \end{bmatrix} = 2 \times 3 - 1 \times 5 = 1$ so the matrix is non-singular.

To find the inverse matrix, we interchange the 2 and 3 and reverse the signs of the other two elements. Since the determinant is 1, this gives us the inverse matrix directly:

$$\begin{bmatrix} 3 & -1 \\ -5 & 2 \end{bmatrix}.$$

To check that this is correct, we calculate the products:

$$\begin{bmatrix} 2 & 1 \\ 5 & 3 \end{bmatrix} \begin{bmatrix} 3 & -1 \\ -5 & 2 \end{bmatrix} = \begin{bmatrix} 1 & 0 \\ 0 & 1 \end{bmatrix}, \quad \begin{bmatrix} 3 & -1 \\ -5 & 2 \end{bmatrix} \begin{bmatrix} 2 & 1 \\ 5 & 3 \end{bmatrix} = \begin{bmatrix} 1 & 0 \\ 0 & 1 \end{bmatrix}.$$

In both cases, the product is the identity matrix confirming that the inverse is correct.

(b) Let $B = \begin{bmatrix} -3 & 2 \\ 0 & -1 \end{bmatrix}$. Then, $\det(B) = \begin{vmatrix} -3 & 2 \\ 0 & -1 \end{vmatrix} = -3 \times -1 - 2 \times 0 = 3$ so the matrix is non-singular.

The necessary interchanges give $\begin{bmatrix} -1 & -2 \\ 0 & -3 \end{bmatrix}$, and, after dividing each element by the

determinant the inverse $B^{-1} = \frac{1}{3} \begin{bmatrix} -1 & -2 \\ 0 & -3 \end{bmatrix} = \begin{bmatrix} -\frac{1}{3} & -\frac{2}{3} \\ 0 & -1 \end{bmatrix}$.

The check gives: $\begin{bmatrix} -3 & 2 \\ 0 & -1 \end{bmatrix} \begin{bmatrix} -\frac{1}{3} & -\frac{2}{3} \\ 0 & -1 \end{bmatrix} = \begin{bmatrix} 1 & 0 \\ 0 & 1 \end{bmatrix}$, $\begin{bmatrix} -\frac{1}{3} & -\frac{2}{3} \\ 0 & -1 \end{bmatrix} \begin{bmatrix} -3 & 2 \\ 0 & -1 \end{bmatrix} = \begin{bmatrix} 1 & 0 \\ 0 & 1 \end{bmatrix}$ (which is correct).

(c) Now, $\det \begin{bmatrix} 2 & 6 \\ 1 & 3 \end{bmatrix} = 2 \times 3 - 6 \times 1 = 0$ so the matrix is singular.

Because the calculation of an inverse involves division by the determinant and division by zero is a forbidden process, singular matrices do not have inverses.

The answers in Example 25.5 can be checked using the TI-83:

First delete any existing matrices from the memory of the calculator – i.e., Press **2nd** ‘+’ ‘2’ ‘5’ and delete the matrices you no longer wish to use. Then define the above matrices as

$[A] = \begin{bmatrix} 2 & 1 \\ 5 & 3 \end{bmatrix}$, $[B] = \begin{bmatrix} -3 & 2 \\ 0 & -1 \end{bmatrix}$ and $[C] = \begin{bmatrix} 2 & 6 \\ 1 & 3 \end{bmatrix}$ and use the **MATH** menu after calling up the

MATRIX option:

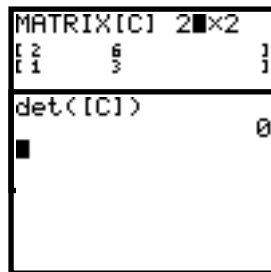

EXAMPLE 25.6

For what value(s) of k will the matrix $A = \begin{bmatrix} k & 2 \\ 3 & k+1 \end{bmatrix}$ be singular?

S
o
l
u
t
i
o
n

If the matrix A is singular, then $|A| = \det(A) = 0$.

$$\begin{aligned} \text{Now, } |A| &= \begin{vmatrix} k & 2 \\ 3 & k+1 \end{vmatrix} = k(k+1) - 2 \times 3 \\ &= k^2 + k - 6 \end{aligned}$$

Then, we must have $k^2 + k - 6 = 0 \Leftrightarrow (k+3)(k-2) = 0$

$$\Leftrightarrow k = -3 \text{ or } k = 2.$$

That is, matrix A will be singular iff $k = -3$ or 2 .

EXAMPLE 25.7

Express the determinant, $\begin{vmatrix} k^2 & 2 \\ 3k & 5 \end{vmatrix}$ in terms of the matrix $A = \begin{bmatrix} 5k & 2 \\ 3 & 1 \end{bmatrix}$.

$$\begin{aligned} \begin{vmatrix} k^2 & 2 \\ 3k & 5 \end{vmatrix} &= 5k^2 - 6k = k(5k - 6) \\ &= k \begin{vmatrix} 5k & 2 \\ 3 & 1 \end{vmatrix} \\ &= k|A| \end{aligned}$$

25.2.2 INVERSE AND DETERMINANT OF 3 BY 3 MATRICES

In the same way that we determined the determinant of a 2 by 2 matrix, we now determine the determinant of a 3 by 3 matrix.

The determinant of a 3 by 3 matrix can be defined in terms of the determinant of 2 by 2 submatrices.

$$\begin{vmatrix} a & b & c \\ d & e & f \\ g & h & i \end{vmatrix} = a \times \begin{vmatrix} e & f \\ h & i \end{vmatrix} - b \times \begin{vmatrix} d & f \\ g & i \end{vmatrix} + c \times \begin{vmatrix} d & e \\ g & h \end{vmatrix}$$

The three terms are made from the elements of the first row paired with the 2 by 2 matrix in the other columns:

$$\begin{vmatrix} a & b & c \\ d & e & f \\ g & h & i \end{vmatrix} = a \times \begin{vmatrix} e & f \\ h & i \end{vmatrix} - b \times \begin{vmatrix} d & f \\ g & i \end{vmatrix} + c \times \begin{vmatrix} d & e \\ g & h \end{vmatrix}$$

$$\begin{vmatrix} a & b & c \\ d & e & f \\ g & h & i \end{vmatrix} = a \times \begin{vmatrix} e & f \\ h & i \end{vmatrix} - b \times \begin{vmatrix} d & f \\ g & i \end{vmatrix} + c \times \begin{vmatrix} d & e \\ g & h \end{vmatrix}$$

$$\begin{vmatrix} a & b & c \\ d & e & f \\ g & h & i \end{vmatrix} = a \times \begin{vmatrix} e & f \\ h & i \end{vmatrix} - b \times \begin{vmatrix} d & f \\ g & i \end{vmatrix} + c \times \begin{vmatrix} d & e \\ g & h \end{vmatrix}$$

The terms are **signed** according to the sum of the row and column in which the single element lies. In the first term, a lies in the first row and first column. This is even and so the term is positive. The second part of the expression uses b . This is in the second row and first column. This is an odd total and so the term is negative. This calculation can also be done working along any row or column that contains ones and/or zeros (if they exist). In short, the sign attached to each term is given by the **alternating sign rule**:

$$\begin{vmatrix} + & - & + \\ - & + & - \\ + & - & + \end{vmatrix}$$

EXAMPLE 25.8

Find the determinant of $\begin{bmatrix} 2 & -1 & 4 \\ 1 & 2 & 0 \\ 2 & 1 & 2 \end{bmatrix}$

S
o
l
u
t
i
o
n

Expanding along the first row gives:

$$\begin{aligned} \begin{vmatrix} 2 & -1 & 4 \\ 1 & 2 & 0 \\ 2 & 1 & 2 \end{vmatrix} &= 2 \begin{vmatrix} 2 & 0 \\ 1 & 2 \end{vmatrix} - (-1) \begin{vmatrix} 1 & 0 \\ 2 & 2 \end{vmatrix} + 4 \begin{vmatrix} 1 & 2 \\ 2 & 1 \end{vmatrix} \\ &= 2(2 \times 2 - 0 \times 1) + 1(1 \times 2 - 2 \times 0) + 4(1 \times 1 - 2 \times 2) \\ &= 2 \times 4 + 1 \times 2 + 4 \times -3 \\ &= 8 + 2 - 12 \\ &= -2 \end{aligned}$$

Similarly, expanding down the first column gives:

$$\begin{aligned} \begin{vmatrix} 2 & -1 & 4 \\ 1 & 2 & 0 \\ 2 & 1 & 2 \end{vmatrix} &= 2 \begin{vmatrix} 2 & 0 \\ 1 & 2 \end{vmatrix} - 1 \begin{vmatrix} -1 & 4 \\ 1 & 2 \end{vmatrix} + 2 \begin{vmatrix} -1 & 4 \\ 2 & 0 \end{vmatrix} \\ &= 2(2 \times 2 - 0 \times 1) - 1(-1 \times 2 - 4 \times 1) + 2(-1 \times 0 - 4 \times 2) \\ &= 2 \times 4 - 1 \times -6 + 2 \times -8 \\ &= 8 + 6 - 16 \\ &= -2 \end{aligned}$$

That is, it does not matter which column or row is used to ‘expand’ the determinant.

As the determinant is not zero, the matrix is, therefore, non-singular.

A quicker calculation would be that obtained from expanding the determinant along the second row, as this contains a 1 and a 0. (This is left for you to verify).

An important result of determinant, is the following:

For any two square matrices, A and B , of the same order, $\det(AB) = \det(A)\det(B)$.

EXAMPLE 25.9

For what value(s) of k will the matrix $\begin{bmatrix} (1-k) & 1 & 1 \\ 1 & (1-k) & 1 \\ 1 & 1 & k \end{bmatrix}$ be singular?

S
o
l
u
t
i
o
n

For the matrix to be singular, then $\begin{vmatrix} (1-k) & 1 & 1 \\ 1 & (1-k) & 1 \\ 1 & 1 & k \end{vmatrix} = 0$

Expanding along the first row we have:

$$\begin{aligned}
 (1-k) \begin{vmatrix} (1-k) & 1 \\ 1 & k \end{vmatrix} - 1 \begin{vmatrix} 1 & 1 \\ 1 & k \end{vmatrix} + 1 \begin{vmatrix} 1 & (1-k) \\ 1 & 1 \end{vmatrix} &= 0 \\
 \therefore (1-k)[k(1-k) - 1] - [k - 1] + [1 - (1-k)] &= 0 \\
 \Leftrightarrow (1-k)(k - k^2 - 1) - k + 1 + k &= 0 \\
 \Leftrightarrow k^3 - 2k^2 - 2k &= 0 \\
 \Leftrightarrow k(k^2 - 2k - 2) &= 0 \\
 \Leftrightarrow k(k - 1 + \sqrt{3})(k - 1 - \sqrt{3}) &= 0 \\
 \therefore k = 0 \text{ or } 1 - \sqrt{3} \text{ or } 1 + \sqrt{3}
 \end{aligned}$$

Checking these solutions by substituting back into the original matrix, we find that for $k = 0$, the determinant is zero, for $k = 1 - \sqrt{3}$ the determinant is $4(1 - \sqrt{3})$ while for $k = 1 + \sqrt{3}$ the determinant is $4(1 + \sqrt{3})$. Therefore, only solution is $k = 0$.

Properties of determinants

There are a number of useful properties of determinants that can reduce the amount of work involved when evaluating them. We list some of these now.

1. If all of the elements of a row (or column) of a matrix A are zero, then $\det(A) = 0$.
2. If two rows (or columns) of a matrix A are identical or in proportion, then $\det(A) = 0$.
3. If any two rows (or columns) of a matrix A are interchanged (call this new matrix B), then, $\det(B) = -\det(A)$.
4. If we add any non-zero multiple of one row (or column) of a matrix A to a different row (or column), (call this new matrix B), then $\det(B) = \det(A)$.
5. If each of the elements in a row (or column) of a matrix A are multiplied by some scalar, k (call this new matrix B), then, $\det(B) = k\det(A)$.

EXAMPLE 25.10

Show that
$$\begin{vmatrix} 1 & 1 & 1 \\ x & y & z \\ x^2 & y^2 & z^2 \end{vmatrix} = (x-y)(y-z)(z-x).$$

S
o
l
u
t
i
o
n

We subtract column 2 from column 1 (i.e., $C_1 - C_2$) and column 3 from column 2 (i.e., $C_2 - C_3$).

$$\text{i.e., } \begin{vmatrix} 1 & 1 & 1 \\ x & y & z \\ x^2 & y^2 & z^2 \end{vmatrix} = \begin{vmatrix} 0 & 0 & 1 \\ x-y & y-z & z \\ x^2-y^2 & y^2-z^2 & z^2 \end{vmatrix}$$

Next, we expand along the first row (as two of the elements are zero):

$$\begin{vmatrix} 0 & 0 & 1 \\ x-y & y-z & z \\ x^2-y^2 & y^2-z^2 & z^2 \end{vmatrix} = 0-0+1 \begin{vmatrix} x-y & y-z \\ x^2-y^2 & y^2-z^2 \end{vmatrix}$$

$$= (x-y)(y^2-z^2) - (y-z)(x^2-y^2)$$

$$= (x-y)(y-z)(y+z) - (y-z)(x-y)(x+y)$$

$$= (x-y)(y-z)[(y+z) - (x+y)]$$

$$= (x-y)(y-z)(z-x)$$

Searching for the inverse of a 3 by 3 matrix

We begin this section by considering the following example.

EXAMPLE 25.11

Find the product AB where $A = \begin{bmatrix} 1 & 1 & 2 \\ 3 & 4 & 1 \\ 1 & 3 & -2 \end{bmatrix}$ and $B = \begin{bmatrix} -11 & 8 & -7 \\ 7 & -4 & 5 \\ 5 & -2 & 1 \end{bmatrix}$

Hence find A^{-1} .

S
o
l
u
t
i
o
n

Using the TI-83 we have:

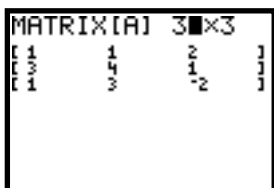

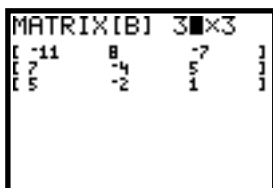

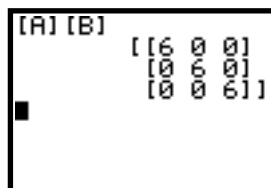

$$\text{So, } AB = \begin{bmatrix} 1 & 1 & 2 \\ 3 & 4 & 1 \\ 1 & 3 & -2 \end{bmatrix} \begin{bmatrix} -11 & 8 & -7 \\ 7 & -4 & 5 \\ 5 & -2 & 1 \end{bmatrix} = \begin{bmatrix} 6 & 0 & 0 \\ 0 & 6 & 0 \\ 0 & 0 & 6 \end{bmatrix}. \text{ That is, } AB = 6I.$$

$$\text{We can rewrite } AB = 6I \text{ as } A \times \left(\frac{1}{6}B\right) = I.$$

However, we also know that $A \times A^{-1} = I$ and so we have that $A^{-1} = \frac{1}{6}B$.

$$\text{That is, } A^{-1} = \frac{1}{6} \begin{bmatrix} -11 & 8 & -7 \\ 7 & -4 & 5 \\ 5 & -2 & 1 \end{bmatrix}.$$

In Example 25.11 we were able to find the inverse of a matrix based on the result that if the product of two matrices produces the identity matrix (or a multiple of the identity matrix) then the matrices must be inverses of each other. The problem here is that we need to be given the two

matrices such that their product will result in the identity matrix (or a multiple of the identity matrix). So, what happens when we do not have two such matrices?

It should also be noted at this stage that the TI-83 can also produce the inverse of a 3 by 3 matrix. Using Example 25.11 we have:



In §25.2.1 we were able to obtain the inverse of non-singular 2 by 2 square matrices. A similar result can also be obtained for a 3 by 3 matrix, however, the process for obtaining the general form for the inverse of a 3 by 3 matrix is beyond the scope of this course. Nonetheless, we can still obtain the inverse of a 3 by 3 (or other squares matrices of higher order) by using a method known as the **Gaussian method**, (also known as the Gauss–Jordan Elimination Method) named after the great mathematician, Carl Friedrich Gauss (1777–1855) and the German geodesist Wilhelm Jordan (1842–1899) who later generalised Gauss’s method to solve problems in large-scale surveying.

The method requires the pairing of the matrix A and the identity matrix, in a form known as the **augmented matrix form**. Then, by making use of basic arithmetic applied to the rows of the augmented matrix we convert the matrix A to the identity matrix – and in the process the identity matrix is converted to A^{-1} . That is,

- Step 1:** Set up augmented matrix form: $[A | I]$
- Step 2:** Use a sequence of **elementary row operations** (i.e., $R_i \rightarrow \alpha R_i + \beta R_j$, replaces R_i with $\alpha R_i + \beta R_j$)
- Step 3:** Continue Step 2 until the augmented matrix $[I | B]$ is achieved.
- Step 4:** $B = A^{-1}$.

EXAMPLE 25.12

Find the inverse of $A = \begin{bmatrix} 2 & -1 & 4 \\ 1 & 2 & 0 \\ 2 & 1 & 2 \end{bmatrix}$.

S
o
l
u
t
i
o
n

We set up the augmented matrix form, $[A | I]$:

$$\left[\begin{array}{ccc|ccc} 2 & -1 & 4 & 1 & 0 & 0 \\ 1 & 2 & 0 & 0 & 1 & 0 \\ 2 & 1 & 2 & 0 & 0 & 1 \end{array} \right]$$

The aim is now to use linear combinations of the rows to reduce the left hand half of the tableau to the identity matrix. The first step is to halve the first row to make the top left entry 1.

MATHEMATICS – Higher Level (Core)

$$R_1 \rightarrow \frac{1}{2} \times R_1 \left[\begin{array}{ccc|ccc} 1 & -\frac{1}{2} & 2 & \frac{1}{2} & 0 & 0 \\ 1 & 2 & 0 & 0 & 1 & 0 \\ 2 & 1 & 2 & 0 & 0 & 1 \end{array} \right]$$

The next step is to replace row 2 with row 2 – row 1 and row 3 with row 3 – twice row 1. This will make the first column correct.

$$\begin{array}{l} R_2 \rightarrow R_2 - R_1 \\ R_3 \rightarrow R_3 - 2R_1 \end{array} \left[\begin{array}{ccc|ccc} 1 & -\frac{1}{2} & 2 & \frac{1}{2} & 0 & 0 \\ 0 & 2\frac{1}{2} & -2 & -\frac{1}{2} & 1 & 0 \\ 0 & 2 & -2 & -1 & 0 & 1 \end{array} \right]$$

The next thing to do is reduce the term in the second row and second column to 1 by dividing each element in the row by $2\frac{1}{2}$.

$$R_2 \rightarrow R_2 \div 2\frac{1}{2} \left[\begin{array}{ccc|ccc} 1 & -\frac{1}{2} & 2 & \frac{1}{2} & 0 & 0 \\ 0 & 1 & -\frac{4}{5} & -\frac{1}{5} & \frac{2}{5} & 0 \\ 0 & 2 & -2 & -1 & 0 & 1 \end{array} \right]$$

Next, we use the term in the second row and second column as the pivot (the basis for reducing the next column). Row 1 is replaced by row 1 + half row 2. Row 3 is replaced by row 3 – twice row 2.

$$\begin{array}{l} R_1 \rightarrow R_1 + \frac{1}{2}R_2 \\ R_3 \rightarrow R_3 - 2R_2 \end{array} \left[\begin{array}{ccc|ccc} 1 & 0 & 1\frac{3}{5} & \frac{2}{5} & \frac{1}{5} & 0 \\ 0 & 1 & -\frac{4}{5} & -\frac{1}{5} & \frac{2}{5} & 0 \\ 0 & 0 & -\frac{2}{5} & -\frac{3}{5} & -\frac{4}{5} & 1 \end{array} \right]$$

Next, reduce the bottom right element to 1 by dividing the bottom row by $-\frac{2}{5}$:

$$R_3 \rightarrow R_3 \div \left(-\frac{2}{5}\right) \left[\begin{array}{ccc|ccc} 1 & 0 & 1\frac{3}{5} & \frac{2}{5} & \frac{1}{5} & 0 \\ 0 & 1 & -\frac{4}{5} & -\frac{1}{5} & \frac{2}{5} & 0 \\ 0 & 0 & 1 & \frac{3}{2} & 2 & -2\frac{1}{2} \end{array} \right]$$

Finally, use the 1 to reduce the elements above it to zero. Replace row 1 by row 1 minus $1\frac{3}{5}$ times

row 3. Row 2 is replaced by row 2 + $\frac{4}{5}$ × row 3.

$$\begin{array}{l} R_1 \rightarrow R_1 - 1\frac{3}{5} \times R_3 \\ R_2 \rightarrow R_2 + \frac{4}{5} \times R_3 \end{array} \left[\begin{array}{ccc|ccc} 1 & 0 & 0 & -2 & -3 & 4 \\ 0 & 1 & 0 & 1 & 2 & -2 \\ 0 & 0 & 1 & \frac{3}{2} & 2 & -2\frac{1}{2} \end{array} \right]$$

From this we can conclude that the inverse of $\begin{bmatrix} 2 & -1 & 4 \\ 1 & 2 & 0 \\ 2 & 1 & 2 \end{bmatrix}$ is $\begin{bmatrix} -2 & -3 & 4 \\ 1 & 2 & -2 \\ \frac{3}{2} & 2 & -2\frac{1}{2} \end{bmatrix}$.

EXERCISES 25.2

1. Find the determinants of the following matrices:

$$\begin{array}{llll} \text{(i)} \quad \begin{bmatrix} 2 & 6 \\ 2 & 4 \end{bmatrix} & \text{(ii)} \quad \begin{bmatrix} 3 & 0 \\ 2 & 3 \end{bmatrix} & \text{(iii)} \quad \begin{bmatrix} -3 & 2 \\ 0 & -4 \end{bmatrix} & \text{(iv)} \quad \begin{bmatrix} 4 & -2 \\ 1 & 0 \end{bmatrix} \\ \text{(v)} \quad \begin{bmatrix} 3 & -3 \\ 4 & 1 \end{bmatrix} & \text{(vi)} \quad \begin{bmatrix} \frac{1}{3} & \frac{2}{3} \\ \frac{1}{3} & \frac{2}{3} \end{bmatrix} & \text{(vii)} \quad \begin{bmatrix} 0.4 & -0.1 \\ -0.2 & 1.3 \end{bmatrix} & \text{(viii)} \quad \begin{bmatrix} \frac{1}{\sqrt{2}} & -\frac{3}{\sqrt{2}} \\ \frac{1}{\sqrt{2}} & \frac{5}{\sqrt{2}} \end{bmatrix} \\ \text{(ix)} \quad \begin{bmatrix} \cos\theta & -\sin\theta \\ \sin\theta & \cos\theta \end{bmatrix} & \text{(x)} \quad \begin{bmatrix} x & 2 \\ 1 & x \end{bmatrix} & \text{(xi)} \quad \begin{bmatrix} \sqrt{a} & a \\ 1 & \sqrt{a} \end{bmatrix} & \text{(xii)} \quad \begin{bmatrix} \frac{\sqrt{3}}{2} & 1 \\ \frac{1}{2} & \sqrt{3} \end{bmatrix} \end{array}$$

2. Find the inverses of these matrices, where they exist.

$$\begin{array}{llll} \text{(i)} \quad \begin{bmatrix} -2 & 4 \\ 1 & 0 \end{bmatrix} & \text{(ii)} \quad \begin{bmatrix} 3 & 2 \\ -4 & -2 \end{bmatrix} & \text{(iii)} \quad \begin{bmatrix} -2 & -2 \\ 4 & -3 \end{bmatrix} & \text{(iv)} \quad \begin{bmatrix} 1 & 0 \\ -2 & -4 \end{bmatrix} \\ \text{(v)} \quad \begin{bmatrix} -4 & -1 \\ 1 & 0 \end{bmatrix} & \text{(vi)} \quad \begin{bmatrix} 3 & 2 \\ 6 & 4 \end{bmatrix} & \text{(vii)} \quad \begin{bmatrix} -1 & -3 \\ 4 & -3 \end{bmatrix} & \text{(viii)} \quad \begin{bmatrix} 3 & -2 \\ 4 & -4 \end{bmatrix} \\ \text{(ix)} \quad \begin{bmatrix} -0.2 & 0.2 \\ -0.2 & -0.8 \end{bmatrix} & \text{(x)} \quad \begin{bmatrix} 0 & 1 \\ \frac{1}{3} & -\frac{1}{3} \end{bmatrix} & \text{(xi)} \quad \begin{bmatrix} \frac{1}{4} & \frac{1}{4} \\ \frac{1}{6} & -\frac{1}{6} \end{bmatrix} & \text{(xii)} \quad \begin{bmatrix} \frac{2}{9} & \frac{1}{3} \\ \frac{1}{9} & -\frac{1}{3} \end{bmatrix} \\ \text{(xiii)} \quad \begin{bmatrix} 3 & 4 \\ 2 & 3 \end{bmatrix} & \text{(xiv)} \quad \begin{bmatrix} x & 1 \\ 2x & 3 \end{bmatrix} & \text{(xv)} \quad \begin{bmatrix} 2 & x \\ 3 & x \end{bmatrix} & \text{(xvi)} \quad \begin{bmatrix} x & x-1 \\ x+1 & \frac{1}{x-1} \end{bmatrix} \end{array}$$

MATHEMATICS – Higher Level (Core)

3. Find the value(s) of x such that $\begin{bmatrix} x & 2 \\ 2 & x \end{bmatrix}$ is singular.

4. Find the value(s) of x such that $\frac{1}{x} \begin{bmatrix} -3 & 4 \\ 3 & 4 \end{bmatrix} \begin{bmatrix} 4 & -4 \\ -3 & -3 \end{bmatrix} = \begin{bmatrix} 1 & 0 \\ 0 & 1 \end{bmatrix}$

5. If $\begin{bmatrix} 2 & 4 \\ 1 & 1 \end{bmatrix} \begin{bmatrix} a & 2 \\ -a & -1 \end{bmatrix} = \begin{bmatrix} 1 & 0 \\ 0 & 1 \end{bmatrix}$, find the value of a .

6. Find the determinant of the following matrices

(a) $\begin{bmatrix} 2 & -1 & 3 \\ 1 & 3 & 4 \\ 2 & 2 & 1 \end{bmatrix}$ (b) $\begin{bmatrix} 4 & -2 & 3 \\ 3 & -1 & -2 \\ 2 & 4 & -1 \end{bmatrix}$ (c) $\begin{bmatrix} 3 & -2 & 1 \\ 2 & 1 & -4 \\ 1 & 1 & -3 \end{bmatrix}$ (d) $\begin{bmatrix} 0 & 3 & -1 \\ 3 & -2 & 1 \\ -2 & 0 & 1 \end{bmatrix}$

7. Using the Gaussian method find the inverse (where it exists) of each of the matrices in Q.6.

8. Find the determinant and using the Gaussian method, find the inverse of $\begin{bmatrix} 1 & 0 & 2 \\ 0 & 2 & 1 \\ 1 & 1 & 0 \end{bmatrix}$.

9. For the matrix: $\begin{bmatrix} -1 & 3 & p \\ 3 & -2 & 1 \\ 4 & -1 & -2 \end{bmatrix}$, find the value of p such that the determinant of the matrix is

35. Find the inverse of this matrix.

10. Prove that for two square matrices A & B , $(AB)^{-1} = B^{-1}A^{-1}$, where $|A| \neq 0 \neq |B|$,

11. Find the determinant and, using the Gaussian method, find the inverse of $\begin{bmatrix} -1 & 0 & -2 \\ 2 & 1 & -1 \\ \frac{1}{2} & \frac{3}{4} & 3 \end{bmatrix}$.

12. Find the value of x such that the matrix $\begin{bmatrix} x & -3 & x \\ -1 & 0 & 2 \\ 2 & 1 & -5 \end{bmatrix}$ is singular.

13. Find the determinant and inverse of the matrix $\begin{bmatrix} 2 & 5 & -2 \\ -1 & 5 & 2 \\ 3 & 1 & -4 \end{bmatrix}$.

14. If A is a 2×2 matrix, and k is a real non-zero number, prove that

(a) $(kA)^{-1} = k^{-1}A^{-1}$ (b) $(A^m)^{-1} = (A^{-1})^m$

- 15.** (a) If $A = \begin{bmatrix} 1 & -2 & 4 \\ 2 & 1 & -2 \\ -1 & 2 & 1 \end{bmatrix}$ and $B = \begin{bmatrix} 1 & 2 & 0 \\ 0 & 1 & 2 \\ 1 & 0 & 1 \end{bmatrix}$, find the product AB . Hence find A^{-1} .
- (b) If $A = \begin{bmatrix} 5 & -8 & -1 \\ 2 & -3 & -1 \\ -3 & 5 & 1 \end{bmatrix}$ and $B = \begin{bmatrix} 2 & 3 & 5 \\ 1 & 2 & 3 \\ 1 & -1 & 1 \end{bmatrix}$, find the product AB . Hence find A^{-1} .
- (c) If $A = \begin{bmatrix} 8 & -1 & -3 \\ 2 & -1 & 0 \\ -7 & 2 & 3 \end{bmatrix}$ and $B = \begin{bmatrix} 1 & 1 & 1 \\ 2 & -1 & 2 \\ 1 & 3 & 2 \end{bmatrix}$, find the product AB . Hence find A^{-1} .

16. Find x for each of the following

(a) $\begin{vmatrix} x-1 & 1 & 2 \\ 1 & 1-x & 1 \\ -1 & 1 & 2-x \end{vmatrix} = 0$ (b) $\begin{vmatrix} 1 & x+1 & x+1 \\ x+1 & 0 & 2 \\ x+1 & 2 & 0 \end{vmatrix} = 0$

17. If $\alpha X^2 + \beta X + \gamma I = O$ and $A = Y^{-1}XY$ prove that $\alpha A^2 + \beta A + \gamma I = O$.

18. (a) If $A = A^{-1}$ prove that $|A|^2 - 1 = 0$.

- (b) Show that for any square matrix A
- i. $|A^n| = |A|^n$.
 - ii. $|kA| = k|A|$.

(c) Prove that $\begin{vmatrix} a+k & b \\ c+k & d \end{vmatrix} = \begin{vmatrix} a & b \\ c & d \end{vmatrix} + \begin{vmatrix} k & b \\ k & d \end{vmatrix}$

(d) If A is a 2×2 matrix, show that $A^2 - (a+d)A + |A|I = O$.

Hence find the real numbers α and β such that $A^2 = \alpha A + \beta I$ and $A = \begin{bmatrix} 5 & 6 \\ 8 & 9 \end{bmatrix}$.

- (e) If $A^2 = A$ show that
- i. show that $(I + A)^2 = I + 3A$.
 - ii. show that $(I + A)^n = I + (2^n - 1)A$.
 - iii. find $|A|$.

19. If $\begin{vmatrix} 1 & ab+cx & c^2 \\ 1 & bc+ax & a^2 \\ 1 & ca+bx & b^2 \end{vmatrix} = 0$ and a, b and c are unequal real numbers, show that $a + b + c = x$.

20. Prove that if $A^2 = I$ then $A = I$ if $|A + I| \neq 0$ and $A = -I$ if $|A - I| \neq 0$

21. Find the value(s) of k for each of the following

(a) $\begin{vmatrix} x & y & x+y \\ y & x+y & x \\ x+y & x & y \end{vmatrix} = k(x^3 + y^3)$ (b) $\begin{vmatrix} x & y & y \\ y & x & y \\ y & y & x \end{vmatrix} = (x - 2ky)(x + ky)^2$

25.3 SIMULTANEOUS EQUATIONS

The special definition of matrix multiplication makes it possible to apply matrix methods to the problem of solving simultaneous equations. A system of two simultaneous equations in two unknowns can be represented as a single matrix equation as follows.

EXAMPLE 25.13

Represent the following pairs of equations in matrix form.

$$(a) \quad \begin{aligned} 4x + 2y &= -2 \\ 4x - y &= -11 \end{aligned} \quad (b) \quad \begin{aligned} x + y &= 1 \\ y &= \frac{3x - 31}{4} \end{aligned}$$

S
o
l
u
t
i
o
n

(a) The matrix version of the pair of equations $\begin{aligned} 4x + 2y &= -2 \\ 4x - y &= -11 \end{aligned}$ is $\begin{bmatrix} 4 & 2 \\ 4 & -1 \end{bmatrix} \begin{bmatrix} x \\ y \end{bmatrix} = \begin{bmatrix} -2 \\ -11 \end{bmatrix}$.

The left hand side is represented by a 2 by 2 matrix containing the coefficients of the equations multiplied by a column matrix containing the variables. The right hand side is represented by a column matrix containing the right hand sides of the original equations.

The reason that the two representations are equivalent can be seen when the matrix version is

expanded:
$$\begin{bmatrix} 4 & 2 \\ 4 & -1 \end{bmatrix} \begin{bmatrix} x \\ y \end{bmatrix} = \begin{bmatrix} -2 \\ -11 \end{bmatrix} \Leftrightarrow \begin{bmatrix} 4x + 2y \\ 4x - y \end{bmatrix} = \begin{bmatrix} -2 \\ -11 \end{bmatrix}$$

The two matrices given as equal above are only equal if corresponding elements are identical. So, the top elements must be equal giving $4x + 2y = -2$ and the bottom elements must be equal giving $4x - y = -11$, which are the two equations we were given.

(ii) The second of the equations $\begin{aligned} x + y &= 1 \\ y &= \frac{3x - 31}{4} \end{aligned}$ must be rearranged to $3x - 4y = 31$

before writing in matrix form to get:
$$\begin{bmatrix} 1 & 1 \\ 3 & -4 \end{bmatrix} \begin{bmatrix} x \\ y \end{bmatrix} = \begin{bmatrix} 1 \\ 31 \end{bmatrix}$$

Now that we can convert a pair of simultaneous equations to matrix form, we are in a position to solve the system. The process for using matrices to solve simultaneous equations can be summarised as follows:

If a system of equations is represented by the matrix equation, $AX = B$, where the matrix A is non-singular (i.e., A^{-1} exists), then,

$$AX = B \Leftrightarrow A^{-1}AX = A^{-1}B \Leftrightarrow X = A^{-1}B$$

This is equivalent to the method used to solve simple equations such as:

$$2x = 12 \Leftrightarrow \frac{1}{2} \times 2x = \frac{1}{2} \times 12 \Leftrightarrow x = 6$$

Central to the method is to multiply both sides of the equation by the multiplicative inverse of the coefficient of x . This coefficient is 2 and its inverse is $\frac{1}{2}$. The result of this process is that the left hand side is reduced to x and the solution is produced.

The process described for solving a matrix equation is very similar to the process used to solve the equation $2x = 12$. The first step is to find the inverse of the matrix of coefficients.

EXAMPLE 25.14

Solve the following pairs of equations using the matrix method.

$$\begin{array}{ll} \text{(a)} & \begin{array}{l} 4x + 2y = -2 \\ 4x - y = -11 \end{array} \\ \text{(b)} & \begin{array}{l} x + y = 1 \\ y = \frac{3x - 31}{4} \end{array} \end{array}$$

S
o
l
u
t
i
o
n

(a) The matrix version of this pair of equations is: $\begin{bmatrix} 4 & 2 \\ 4 & -1 \end{bmatrix} \begin{bmatrix} x \\ y \end{bmatrix} = \begin{bmatrix} -2 \\ -11 \end{bmatrix}$ (i.e., $AX = B$)

This can be solved by pre-multiplying both sides of this equation by the inverse of the 2 by 2

coefficients matrix. In this case the coefficient matrix is $\begin{bmatrix} 4 & 2 \\ 4 & -1 \end{bmatrix}$ and the inverse is

$$\begin{bmatrix} \frac{1}{12} & \frac{1}{6} \\ \frac{1}{3} & -\frac{1}{3} \end{bmatrix}. \text{ So, we have } \begin{bmatrix} \frac{1}{12} & \frac{1}{6} \\ \frac{1}{3} & -\frac{1}{3} \end{bmatrix} \begin{bmatrix} 4 & 2 \\ 4 & -1 \end{bmatrix} \begin{bmatrix} x \\ y \end{bmatrix} = \begin{bmatrix} \frac{1}{12} & \frac{1}{6} \\ \frac{1}{3} & -\frac{1}{3} \end{bmatrix} \begin{bmatrix} -2 \\ -11 \end{bmatrix} \text{ (i.e., } AX = B \Leftrightarrow A^{-1}AX = A^{-1}B \text{).}$$

Remember that matrix multiplication is non-commutative and that we must be careful to **pre-multiply by the inverse** on both sides of the equation. This version of the problem looks much more complicated than other methods such as substitution. This, however, is not really the case as the left hand side (much as it does in the case of simple algebraic equations) should simplify to the matrix of the unknowns.

$$\begin{bmatrix} 1 & 0 \\ 0 & 1 \end{bmatrix} \begin{bmatrix} x \\ y \end{bmatrix} = \begin{bmatrix} \frac{1}{12} & \frac{1}{6} \\ \frac{1}{3} & -\frac{1}{3} \end{bmatrix} \begin{bmatrix} -2 \\ -11 \end{bmatrix} \Leftrightarrow \begin{bmatrix} x \\ y \end{bmatrix} = \begin{bmatrix} \frac{1}{12} & \frac{1}{6} \\ \frac{1}{3} & -\frac{1}{3} \end{bmatrix} \begin{bmatrix} -2 \\ -11 \end{bmatrix} \text{ (i.e., } X = A^{-1}B \text{)}$$

This should always be the case, provided the inverse has been found correctly, and so does not require any work. All that is necessary is to perform the matrix multiplication on the right hand side.

$$\begin{bmatrix} x \\ y \end{bmatrix} = \begin{bmatrix} -2 \\ 3 \end{bmatrix}$$

The solution is $x = -2, y = 3$ or, as a number pair $(-2, 3)$.

(b) In matrix form, this is: $\begin{bmatrix} 1 & 1 \\ 3 & -4 \end{bmatrix} \begin{bmatrix} x \\ y \end{bmatrix} = \begin{bmatrix} 1 \\ 31 \end{bmatrix}$. The inverse of $\begin{bmatrix} 1 & 1 \\ 3 & -4 \end{bmatrix}$ is $\frac{1}{7} \begin{bmatrix} 4 & 1 \\ 3 & -1 \end{bmatrix}$.

Pre-multiplication by this inverse gives: $\frac{1}{7} \begin{bmatrix} 4 & 1 \\ 3 & -1 \end{bmatrix} \begin{bmatrix} 1 & 1 \\ 3 & -4 \end{bmatrix} \begin{bmatrix} x \\ y \end{bmatrix} = \frac{1}{7} \begin{bmatrix} 4 & 1 \\ 3 & -1 \end{bmatrix} \begin{bmatrix} 1 \\ 31 \end{bmatrix} \Leftrightarrow \begin{bmatrix} x \\ y \end{bmatrix} = \begin{bmatrix} 5 \\ -4 \end{bmatrix}$

The solution is $x = 5, y = -4$ or, as a number pair $(5, -4)$.

Such a system of equations can also be solved by adapting the Gaussian method encountered in the previous section. This adaptation requires that we write the system of equations, $AX = B$, in the augmented matrix form $[A \mid B]$.

That is,
$$\begin{matrix} a_1x + b_1y = c_1 \\ a_2x + b_2y = c_2 \end{matrix} \Leftrightarrow \begin{bmatrix} a_1 & b_1 \\ a_2 & b_2 \end{bmatrix} \begin{bmatrix} x \\ y \end{bmatrix} = \begin{bmatrix} c_1 \\ c_2 \end{bmatrix} \Leftrightarrow \left[\begin{array}{cc|c} a_1 & b_1 & c_1 \\ a_2 & b_2 & c_2 \end{array} \right]$$

Then, once we have the augmented form we use elementary row operations to achieve the

solution form:
$$\left[\begin{array}{cc|c} 1 & 0 & d_1 \\ 0 & 1 & d_2 \end{array} \right], \text{ i.e., } x = d_1 \text{ and } y = d_2.$$

EXAMPLE 25.15

Use the Gaussian method to solve the system of equations
$$\begin{matrix} 4x + 2y = -2 \\ 4x - y = -11 \end{matrix}$$

**S
o
l
u
t
i
o
n**

The system of equations has the augmented matrix form:
$$\left[\begin{array}{cc|c} 4 & 2 & -2 \\ 4 & -1 & -11 \end{array} \right]$$

Using elementary row operations we have:
$$\begin{matrix} R_1 \rightarrow \frac{1}{4}R_1 \\ R_2 \rightarrow R_2 - R_1 \end{matrix} \left[\begin{array}{cc|c} 1 & \frac{1}{2} & -\frac{1}{2} \\ 0 & -3 & -9 \end{array} \right]$$

$$R_2 \rightarrow -\frac{1}{3}R_2 \left[\begin{array}{cc|c} 1 & \frac{1}{2} & -\frac{1}{2} \\ 0 & 1 & 3 \end{array} \right]$$

$$R_1 \rightarrow R_1 - \frac{1}{2}R_2 \left[\begin{array}{cc|c} 1 & 0 & -2 \\ 0 & 1 & 3 \end{array} \right]$$

From which we then have the solution $x = -2$ and $y = 3$.

Using a Graphics Calculator

Both methods that were used in Examples 25.13 and 25.14 can also be solved using the TI-83.

Matrix Form

The matrix method is particularly suited to implementation on a graphics calculator. Returning to

the first of these examples, $\begin{bmatrix} 4 & 2 \\ 4 & -1 \end{bmatrix} \begin{bmatrix} x \\ y \end{bmatrix} = \begin{bmatrix} -2 \\ -11 \end{bmatrix}$, the solution would proceed as follows:

The matrices $A = \begin{bmatrix} 4 & 2 \\ 4 & -1 \end{bmatrix}$, $B = \begin{bmatrix} -2 \\ -11 \end{bmatrix}$ must be entered under

the **MATRIX EDIT** menu. Remember to use the key (-) for negative quantities, not the subtraction key.

Now pre-multiply B by the inverse of A . Using the TI-82/3, the names of the matrices are accessed using the **MATRIX NAMES** menu. The inverse of A is calculated using the x^{-1} key. The sequence of operations is to first return to the home screen by using **2nd QUIT**. Then use **MATRIX NAMES** and select matrix A . Press x^{-1} and finally use **MATRIX NAMES** and select matrix B .

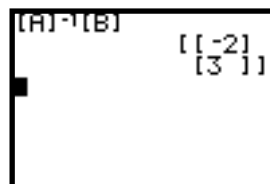
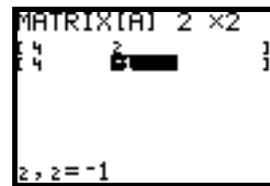

Augmented Matrix form

The TI-83 can also be used to set up our matrix equation, $AX = B$, into its augmented matrix form.

- Step 1:** Define the matrix A and B .
- Step 2:** Call up the **MATRIX** window and then select the **MATH** menu followed by option **7:augment**(
Enter the matrices in the correct order, A first followed by ‘,’ and then B followed by ‘)’.
- Step 3:** Store the augmented matrix by pressing **STO** followed by calling up the **MATRIX** window and selecting a matrix $[C]$ (say) and then press **ENTER**.
- Step 4:** Call up the **MATRIX** window and select the **MATH** menu from which option **B:rref**(is selected (make use of the down arrow key). Then press **ENTER**.
- Step 5:** Select the **MATRIX** Window and choose matrix $[C]$ press ‘)’ and then **ENTER**. This will provide the **reduced row-echelon** form which will enable us to quote the solutions directly from the screen.

From the last screen, we have the solution $x = -2$ and $y = 3$.

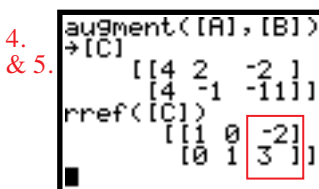
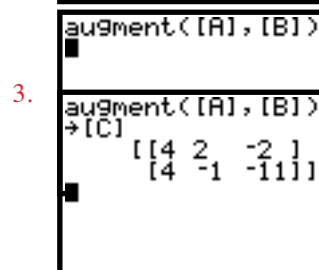
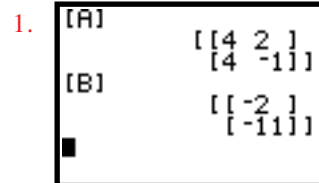

MATHEMATICS – Higher Level (Core)

There are occasions on which simultaneous equations either have no solutions or infinite solution sets. This problem was covered in Chapter 2, §2.3. If we use the matrix method to solve one of these types of equations, we will find that the matrix of coefficients is singular and has no inverse. In this case, the simple matrix method fails. If you encounter a pair of equations of this type, it is best to handle them using an algebraic method as the matrix method, i.e., $AX = B$, will not tell you whether the equations have no solutions or an infinite solution set.

However, using the augmented matrix form $[A \mid B]$, then depending on the end form of the reduced row-echelon matrix we have the following results:

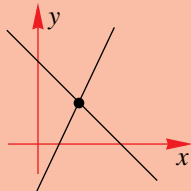
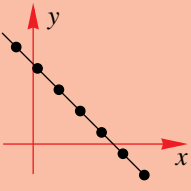
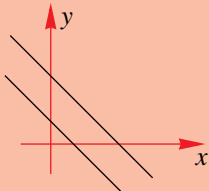
Form 1	Form 2	Form 3
Unique solution	Infinitely many solutions	No solution
$\left[\begin{array}{cc c} 1 & 0 & d_1 \\ 0 & 1 & d_2 \end{array} \right]$	$\left[\begin{array}{cc c} 1 & k & d_1 \\ 0 & 0 & 0 \end{array} \right]$	$\left[\begin{array}{cc c} 1 & k & d_1 \\ 0 & 0 & d_2 \end{array} \right]$
where $d_2 \neq 0$.		
		
Lines intersect at one unique point.	Lines are coincident. i.e. they are identical.	Lines are parallel and so never meet.

The methods described for 2 by 2 matrices hold equally for 3 by 3 matrices.

EXAMPLE 25.16

Find the product AB where $A = \begin{bmatrix} 1 & 1 & 2 \\ 3 & 4 & 1 \\ 1 & 3 & -2 \end{bmatrix}$ and $B = \begin{bmatrix} -11 & 8 & -7 \\ 7 & -4 & 5 \\ 5 & -2 & 1 \end{bmatrix}$

$$x + y + 2z = 9$$

Hence solve the system of equations $3x + 4y + z = -2$

$$x + 3y - 2z = 4$$

Solution

From Example 25.11 we have that $AB = \begin{bmatrix} 1 & 1 & 2 \\ 3 & 4 & 1 \\ 1 & 3 & -2 \end{bmatrix} \begin{bmatrix} -11 & 8 & -7 \\ 7 & -4 & 5 \\ 5 & -2 & 1 \end{bmatrix} = \begin{bmatrix} 6 & 0 & 0 \\ 0 & 6 & 0 \\ 0 & 0 & 6 \end{bmatrix} = 6I$

Then, as $AB = 6I \Rightarrow A^{-1} = \frac{1}{6}B$ and $B^{-1} = \frac{1}{6}A$.

In the matrix form we have the system of equations as $\begin{bmatrix} 1 & 1 & 2 \\ 3 & 4 & 1 \\ 1 & 3 & -2 \end{bmatrix} \begin{bmatrix} x \\ y \\ z \end{bmatrix} = \begin{bmatrix} 9 \\ -2 \\ 4 \end{bmatrix}$ or $A \begin{bmatrix} x \\ y \\ z \end{bmatrix} = \begin{bmatrix} 9 \\ -2 \\ 4 \end{bmatrix}$.

So, pre-multiplying both sides by A^{-1} we have $A^{-1}A \begin{bmatrix} x \\ y \\ z \end{bmatrix} = A^{-1} \begin{bmatrix} 9 \\ -2 \\ 4 \end{bmatrix}$ or $I \begin{bmatrix} x \\ y \\ z \end{bmatrix} = A^{-1} \begin{bmatrix} 9 \\ -2 \\ 4 \end{bmatrix}$.

$$\text{But, } I \begin{bmatrix} x \\ y \\ z \end{bmatrix} = \begin{bmatrix} x \\ y \\ z \end{bmatrix} \text{ and } A^{-1} \begin{bmatrix} 9 \\ -2 \\ 4 \end{bmatrix} = \frac{1}{6}B \begin{bmatrix} 9 \\ -2 \\ 4 \end{bmatrix} = \frac{1}{6} \begin{bmatrix} -11 & 8 & -7 \\ 7 & -4 & 5 \\ 5 & -2 & 1 \end{bmatrix} \begin{bmatrix} 9 \\ -2 \\ 4 \end{bmatrix} = \frac{1}{6} \begin{bmatrix} -143 \\ 91 \\ 53 \end{bmatrix}$$

$$\text{And so we have } \begin{bmatrix} x \\ y \\ z \end{bmatrix} = \frac{1}{6} \begin{bmatrix} -143 \\ 91 \\ 53 \end{bmatrix} \Leftrightarrow x = -\frac{143}{6}, y = \frac{91}{6}, z = \frac{53}{6}.$$

(Of course, we used a graphics calculator to evaluate the required products.)

EXAMPLE 25.17

$$\begin{aligned} x + 2y + z &= 6 \\ \text{Solve the system of equations } x - y - z &= -1. \\ 3x - y - 2z &= 2 \end{aligned}$$

S
o
l
u
t
i
o
n

In this case we will make use of the Gaussian method. Setting up the augmented matrix

$$\text{form we have: } \left[\begin{array}{ccc|c} 1 & 2 & 1 & 6 \\ 1 & -1 & -1 & -1 \\ 3 & -1 & -2 & 2 \end{array} \right]$$

Applying elementary row operations we have:

$$\begin{aligned} R_2 &\rightarrow R_2 - R_1 \\ R_3 &\rightarrow R_3 - 3R_1 \end{aligned} \left[\begin{array}{ccc|c} 1 & 2 & 1 & 6 \\ 0 & -3 & -2 & -7 \\ 0 & -7 & -5 & -16 \end{array} \right]$$

$$R_3 \rightarrow 3R_3 - 7R_2 \left[\begin{array}{ccc|c} 1 & 2 & 1 & 6 \\ 0 & -3 & -2 & -7 \\ 0 & 0 & -1 & 1 \end{array} \right]$$

$$\begin{aligned} R_1 &\rightarrow R_1 + R_3 \\ R_2 &\rightarrow R_2 - 2R_3 \\ R_3 &\rightarrow -R_3 \end{aligned} \left[\begin{array}{ccc|c} 1 & 2 & 0 & 7 \\ 0 & -3 & 0 & -9 \\ 0 & 0 & 1 & -1 \end{array} \right]$$

$$\begin{aligned} R_1 &\rightarrow R_1 + \frac{2}{3}R_2 \\ R_2 &\rightarrow \frac{1}{3}R_2 \end{aligned} \left[\begin{array}{ccc|c} 1 & 0 & 0 & 1 \\ 0 & 1 & 0 & 3 \\ 0 & 0 & 1 & -1 \end{array} \right]$$

And so the solution set is $x = 1, y = 3$ and $z = -1$.

MATHEMATICS – Higher Level (Core)

However, making use of the TI-83 is so much quicker!

```

augment([A],[B])
→[C]
[[1 2 1 6]
 [1 -1 -1 -1]
 [3 -1 -2 2]]

rref([C])
[[1 0 0 1]
 [0 1 0 3]
 [0 0 1 -1]]
    
```

Again, the issues dealing with a unique solution, no solution and an infinite number of solutions are dealt with in detail in Chapter 2. A similar summary to that provided for a 2 by 2 system can be presented – so, we conclude our work on solutions to systems of equations in three unknowns with a summary for the 3 by 3 (or really 3 by 4) augmented matrix form and leave it to you to refer back to Chapter 2, §2.3. Suffice to say, however, that if the inverse matrix exists, then a unique solution will exist.

Form 1	Form 2	Form 3
Unique solution	Infinitely many solutions	No solution
$\left[\begin{array}{ccc c} 1 & 0 & 0 & d_1 \\ 0 & 1 & 0 & d_2 \\ 0 & 0 & 1 & d_3 \end{array} \right]$	$\left[\begin{array}{ccc c} 1 & m & n & d_1 \\ 0 & 1 & k & d_2 \\ 0 & 0 & 0 & 0 \end{array} \right]$	$\left[\begin{array}{ccc c} 1 & m & n & d_1 \\ 0 & 1 & k & d_2 \\ 0 & 0 & 0 & d_3 \end{array} \right]$ <p>Where $d_3 \neq 0$</p>
<p>Geometrically: Three planes meet at one point.</p>	<p>Geometrically: Three planes meet along one line.</p>	<p>Geometrically: At least two planes are parallel.</p>

NOTE: There are other geometrical outcomes:

No solutions:

- Two of the planes meet along a line and this line is parallel to (and does not meet) the third plane.

Infinitely many solutions:

- The three planes are coincident.

EXERCISES 25.3

1. Solve the following pairs of simultaneous equations using the matrix method. Give your answers as ordered pairs, (x, y) .

- | | | |
|---|---|--|
| (i) $3x - 2y = 5$
$x + y = 0$ | (ii) $2x + 2y = 2$
$4x + 3y = 7$ | (iii) $-4x + y = 9$
$2x = -6$ |
| (iv) $x + 3y = -5$
$x - y = -1$ | (v) $5x - 3y = -5$
$-3x + 3y = 9$ | (vi) $y = \frac{5 - 5x}{2}$
$6x - 4y = 6$ |
| (vii) $-3x + 4y = 12$
$4x - 2y = -6$ | (viii) $x + 3y = 10$
$4x - 2y = -16$ | (ix) $2x + 3y = 7$
$-2x + 4y = 7$ |

(x) $0.2x + 0.4y = 0.64$ (xi) $y = \frac{x-11}{4}$ (xii) $x + 2y = 2$
 $-0.4x - 3y = -2.6$ $y - x = -2$ $2x + 3y = 2$

(xiii) $\frac{2}{3}x + \frac{1}{2}y = 2\frac{1}{6}$ (xiv) $-x - 2.5y = 0$ (xv) $1.6x - 0.8y = 4.8$
 $\frac{1}{3}x + 5y = 2\frac{2}{3}$ $1.5x + 2y = 3.5$ $5x - 0.2y = 24.2$

2. Find the values of a and b such that the equations $3x + ay = 2$ have:
 $-6x + 4y = b$
- (i) an infinite set of solutions (ii) no solutions.

3. If the equations $ax + y = 7$ have no solutions, what are the possible value(s) of a .
 $4x + ay = 19$

4. Use a graphics calculator to solve the simultaneous equations:

(a) $3x + 7y + 4z = -10$ $x + 2z = 3$ $x - y + 4z = -2$
 $4x - 2y + 3z = 16$ (b) $2x + 3y - z = 2$ (c) $3x - y + z = 1$
 $-x + 3y - 2z = -14$ $x + y - 2z = 4$ $2x - 2y + 3z = 3$

5. Find AB if $A = \begin{bmatrix} 5 & -8 & -1 \\ 2 & -3 & -1 \\ -3 & 5 & 1 \end{bmatrix}$ and $B = \begin{bmatrix} 2 & 3 & 5 \\ 1 & 2 & 3 \\ 1 & -1 & 1 \end{bmatrix}$. Hence solve $2a + 3b + 5c = 8$
 $a + 2b + 3c = -5$.
 $a - b + c = 2$

6. Find AB if $A = \begin{bmatrix} 3 & 4 & 1 \\ 13 & -1 & -3 \\ 5 & 3 & -2 \end{bmatrix}$ and $B = \begin{bmatrix} 1 & 1 & -1 \\ 1 & -1 & 2 \\ 4 & 1 & -5 \end{bmatrix}$. Hence solve $3x + 4y + z = 5$
 $13x - y - 3z = 2$.
 $5x + 3y - 2z = 3$

7. For what value(s) of m will the system of equations $x + my = 2$ have
 $(m - 1)x + 2y = m$
- (a) a unique solution?
 (b) no solution?
 (c) an infinite number of solutions?
- Give a geometrical interpretation for each of these cases.

8. Find the determinant of $A = \begin{bmatrix} p & 3 \\ 2 & \frac{1}{p-1} \end{bmatrix}$. For what values of p and k will the system of

equations $px + 3y = k$ have
 $2(p - 1)x + y = 2$

- (a) a unique solution?
 (b) no solution?
 (c) an infinite number of solutions?

MATHEMATICS – Higher Level (Core)

9. Use the Gaussian method to solve the following systems of equations.

(a)	$3x + 4y = 12$	(b)	$-x + 2y = 6$	(c)	$4x + y = 5$
	$2x - 3y = 8$		$2x - 4y = 9$		$-x - 3y = 7$
	$x + 3y - z = 13$		$x + 2y = 10$		$x - 2y - 3z = 3$
(d)	$3x + y - z = 11$	(e)	$3x + 2y - 4z = 18$	(f)	$x + y - 2z = 7$
	$x + y - 3z = 11$		$y + z = 3$		$2x - 3y - 2z = 0$
	$x - y - z = 2$		$x - 2y = -1$		$-2x + y - 2z = 5$
(g)	$3x + 3y - 7z = 7$	(h)	$-x - y + 3z = 1$	(i)	$x + 4z = 1$
	$x + 2y - 3z = 3$		$y - z = 0$		$x + y + 10z = 10$

10. A parabola passes through the points $(-1, -19)$, $(2, 2)$ and $(3, 13)$. Set up a system of equations that satisfy these conditions. Use the Gaussian method to find its equation.

11. A parabola passes through the points $(-1, -19)$, $(2, 2)$. Set up a system of equations that satisfy these conditions. Use the Gaussian method to find its equation.

12. (a) If $A = \begin{bmatrix} 3 & 1 & 2 \\ -2 & 3 & -1 \end{bmatrix}$ and $X = \begin{bmatrix} x \\ y \\ z \end{bmatrix}$, solve the system of equations $AX = B$ where

i. $B = \begin{bmatrix} 0 \\ 0 \end{bmatrix}$ ii. $B = \begin{bmatrix} 2 \\ -1 \end{bmatrix}$

$$3x + y + 2z = 0$$

(b) Solve the system of equations $-2x + 3y - z = 0$.

$$x + y + z = 0$$

13. (a) Solve for $\begin{vmatrix} t & 1 & 1 \\ 1 & t & 1 \\ 1 & 1 & t \end{vmatrix} = 0$.

$$\lambda x + y + z = 3$$

(b) For what value(s) of λ will the system of equations $x + \lambda y + z = 2$ have

$$x + y + \lambda z = 1$$

- i. no solutions?
- ii. a unique solution?
- iii. an infinite number of solutions?

26.1 INTRODUCTION TO VECTORS

26.1.1 SCALAR AND VECTOR QUANTITIES

Numerical measurement scales are in widespread use. It is important to be able to distinguish between two distinct types of measurement scales, **scalars** and **vectors**.

Scalar Quantities

A scalar is a quantity that has **magnitude** (size) but no **direction**. For example, we measure the mass of objects using a variety of scales such as ‘kilograms’ and ‘pounds’. These measures have **magnitude** in that more massive objects (such as the sun) have a larger numerical mass than small objects (such as this book). Giving the mass of this book does not, however, imply that this mass has a direction. This does **not** mean that scalar quantities must be positive. **Signed** scalar quantities, such as temperature as measured by the Celsius or Fahrenheit scales (which are commonly used) also exist.

Vector Quantities

Some measurements have both **magnitude** and **direction**. When we pull on a door handle, we exert what is known as a **force**. The force that we exert has both magnitude (we either pull hard or we pull gently) and direction (we open or close the door). Both the size of the pull and its direction are important in determining its effect. Such quantities are said to be **vectors**. Other examples of vectors are velocity, acceleration and displacement. The mathematics that will be developed in this section can be applied to problems involving any type of vector quantity.

EXERCISES 26.1

The following situations need to be described using an appropriate measure. Classify the measure as a scalar (s) or a vector (v).

1. A classroom chair is moved from the front of the room to the back.
2. The balance in a bank account.
3. The electric current passing through an electric light tube.
4. A dog, out for a walk, is being restrained by a lead.
5. An aircraft starts its takeoff run.
6. The wind conditions before a yacht race.
7. The amount of liquid in a jug.
8. The length of a car.

26.2 REPRESENTING VECTORS

26.2.1 DIRECTED LINE SEGMENT

There are a number of commonly used notations for vectors:

Notation 1:

This vector runs from A to B and is depicted as \overrightarrow{AB} or \mathbf{AB} with the arrow giving the direction of the vector. Point A is known as the **tail** of the vector \overrightarrow{AB} and point B is known as the **head** of vector \overrightarrow{AB} .

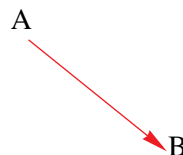

We also say the \overrightarrow{AB} is the position vector of B relative to (from) A.

In the case where a vector starts at the origin (O), the vector running from O to another point C is simply called the **position vector** of C, \overrightarrow{OC} or \mathbf{OC} .

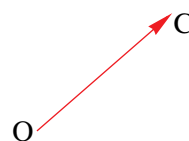

Notation 2:

Rather than using two reference points, A and B, as in notation 1, we can also refer to a vector by making reference to a single letter attached to an arrow. In essence we are ‘naming’ the vector.

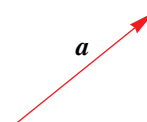

The vector \mathbf{a} can be expressed in several ways. In text books they are often displayed in bold type, however, in written work, the following notations are generally used:

$$\mathbf{a} = \mathbf{a} = \vec{a}$$

We will consider another vector notation later in this chapter.

26.2.2 MAGNITUDE OF A VECTOR

The magnitude or modulus of a vector is its length, which is the distance between its tail and head. We denote the magnitude of \mathbf{AB} by $|\mathbf{AB}|$ (or more simply by AB).

Similarly, if we are using vector notation 2, we may denote the magnitude of \mathbf{a} by $|\mathbf{a}| = a$.

Note then that $|\mathbf{a}| \geq 0$.

26.2.3 EQUAL VECTORS

Two vectors \mathbf{a} and \mathbf{b} are said to be equal if they have the same direction and the same magnitude. i.e., $\mathbf{a} = \mathbf{b}$ if they point in the same direction and $|\mathbf{a}| = |\mathbf{b}|$.

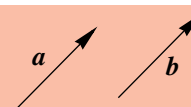

Notice that if $\mathbf{a} = \mathbf{b}$, then vector \mathbf{b} is simply a **translation** of vector \mathbf{a} . Using this notation, where

there is no reference to a fixed point in space, we often use the word *free* vectors. That is, **free vectors** are vectors that have no specific position associated with them. In the diagram below, although the four vectors occupy a different space, they are all equal.

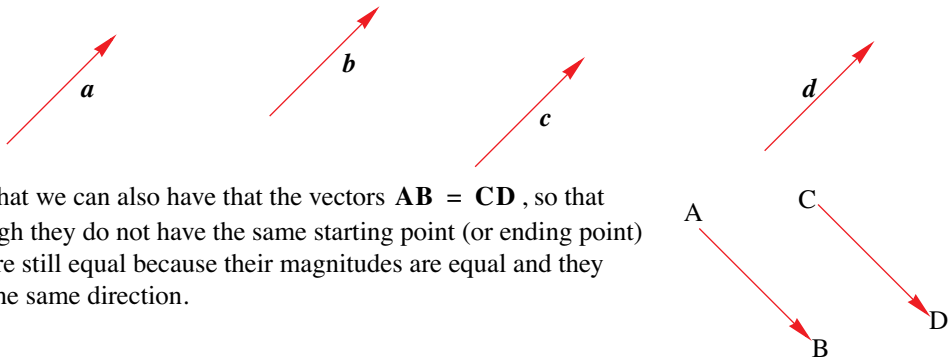

Note that we can also have that the vectors $\mathbf{AB} = \mathbf{CD}$, so that although they do not have the same starting point (or ending point) they are still equal because their magnitudes are equal and they have the same direction.

26.2.4 NEGATIVE VECTORS

The **negative of a vector** \mathbf{a} , denoted by $-\mathbf{a}$ is the vector \mathbf{a} but pointing in the opposite direction to \mathbf{a} .

Similarly, the negative of \mathbf{AB} is $-\mathbf{AB}$ or \mathbf{BA} , because rather than starting at A and ending at B the negative of \mathbf{AB} starts at B and ends at A.

Note that $|\mathbf{a}| = |-\mathbf{a}|$ and $|\mathbf{AB}| = |-\mathbf{AB}| = |\mathbf{BA}|$.

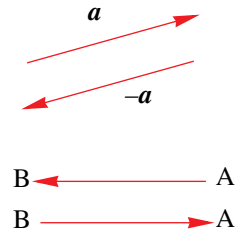

26.2.5 ZERO VECTOR

The zero vector has zero magnitude, $|\mathbf{0}| = 0$ and has no definite direction. It is represented geometrically by joining a point onto itself. Note then that for any non-zero vector \mathbf{a} , $|\mathbf{a}| > 0$

26.2.6 ORIENTATION AND VECTORS

Vectors are very useful when representing positions relative to some starting point. Consider
 (a) the position of a man who has walked 2.8 km across a field in a direction East 30° S or
 (b) a car moving at 20 km/h in a direction West 40° N for 2 hours.
 Each of these descriptions can be represented by a vector.

We start by setting up a set of axes and then we represent the above vectors showing the appropriate direction and magnitude. Representing the magnitude can be done using a scale drawing or labelling the length of the vector.

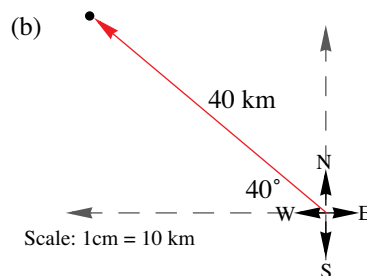
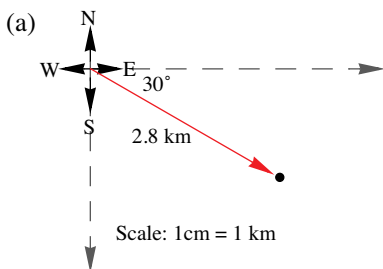

EXAMPLE 26.1

Find the position of a bushwalker if on the first part of her journey she walks 2.8 km across a field in a direction East 30° South and then continues for a further 4 km in a Northerly direction.

S
O
L
I
T
I
O
N

We start by representing her journey using a vector diagram:

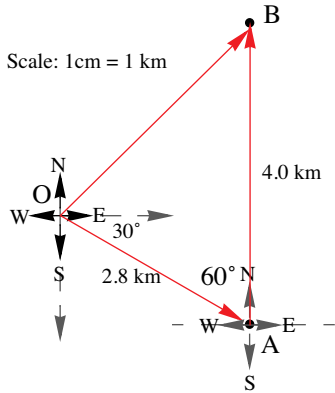

The first part of her journey is represented by vector **OA** and the second part by **AB**. Note then that because her final position is at point B, her final position, relative to O, is given by the vector **OB**.

All that remains is to find the direction of **OB** and its magnitude. To do this we make use of trigonometry.

Finding $|\mathbf{OB}|$:

Using the cosine rule we have

$$\begin{aligned} \mathbf{OB}^2 &= \mathbf{OA}^2 + \mathbf{AB}^2 - 2(\mathbf{AB})(\mathbf{OA})\cos(60^\circ) \\ \mathbf{OB}^2 &= 2.8^2 + 4.0^2 - 2 \times 2.8 \times 4.0 \times 0.5 \\ &= 12.64 \\ \therefore \mathbf{OB} &= 3.56 \end{aligned}$$

Next, we find the angle BOA:

$$\begin{aligned} \mathbf{AB}^2 &= \mathbf{OA}^2 + \mathbf{OB}^2 - 2(\mathbf{OA})(\mathbf{OB})\cos(\angle\mathbf{BOA}) \\ 4.0^2 &= 2.8^2 + 12.64 - 2(2.8)(\sqrt{12.64})\cos(\angle\mathbf{BOA}) \\ \therefore \cos(\angle\mathbf{BOA}) &= \frac{2.8^2 + 12.64 - 4.0^2}{2(2.8)(\sqrt{12.64})} \\ \angle\mathbf{BOA} &= \cos^{-1}(0.2250) \\ &= 76^\circ 59' 45'' \\ &\approx 77^\circ \end{aligned}$$

That is, the bushwalker is 3.56 km E 47° N from her starting point.

Although we will investigate the algebra of vectors in the next section, with Example 26.1 we have already looked at adding two vectors informally. That is, the final vector **OB** was found by *joining* the vectors **OA** and **AB**. Writing this in vector form we have, $\mathbf{OB} = \mathbf{OA} + \mathbf{AB}$.

To add two vectors, **a** and **b**, geometrically we

1. first draw **a**,
2. draw vector **b** so that its tail meets the arrow end of vector **a**,
3. draw a line segment from the tail of vector **a** to the arrow end of vector **b**.

This vector then represents the result $\mathbf{a} + \mathbf{b}$.

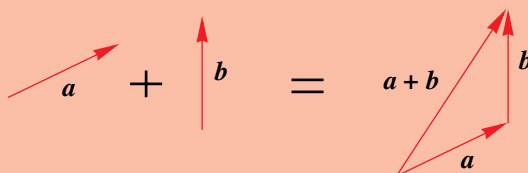

EXAMPLE 26.2

For the equilateral triangle shown, express in terms of a and b

- (a) \mathbf{CA} (c) \mathbf{BC} (d) $|\mathbf{AB} + \mathbf{BC}|$

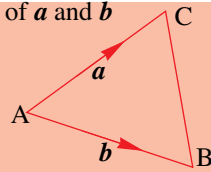

Solution

- (a) $\mathbf{CA} = -\mathbf{AC} = -a$.
 (b) To get from B to C we first get from B to A and then from A to C. That is, we ‘join’ the vectors \mathbf{BA} and \mathbf{AC} . In vector notation we have:

$$\mathbf{BC} = \mathbf{BA} + \mathbf{AC}$$

However, $\mathbf{AB} = b \Rightarrow \mathbf{BA} = -\mathbf{AB} = -b$

$$\therefore \mathbf{BC} = -b + a$$

- (c) $\mathbf{AB} + \mathbf{BC} = \mathbf{AC} = a \therefore |\mathbf{AB} + \mathbf{BC}| = |a|$.

EXERCISES 26.2

1. Using a scale of 1 cm representing 10 units sketch the vectors that represent
 (a) 30 km in a Westerly direction.
 (b) 20 newtons applied in a NS direction.
 (c) 15 m/s N 60° E.
 (d) 45 km/h W 30° S.

2. The vector \longleftarrow represents a velocity of 20 m/s due West. Represent the following vectors:
 (a) 20 m/s due East
 (b) 40 m/s due West
 (c) 60 m/s due East
 (d) 40 m/s due NE

3. State which of the vectors shown
 (a) have the same magnitude.
 (b) are in the same direction.
 (c) are in the opposite direction.
 (d) are equal.
 (e) are parallel.

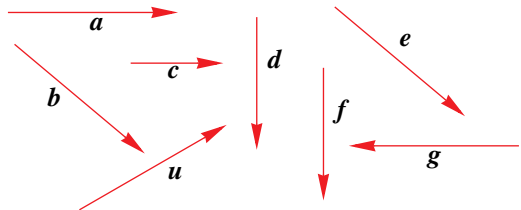

4. For each of the following pairs of vectors, find $a + b$.

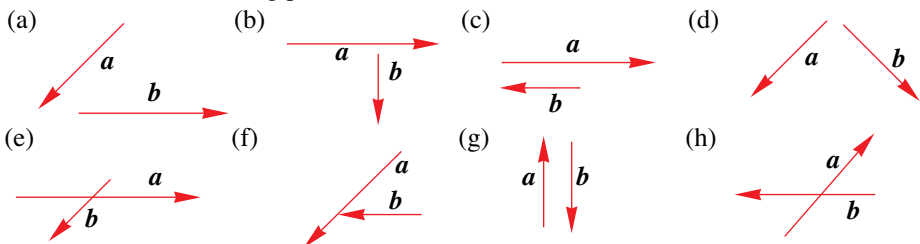

MATHEMATICS – Higher Level (Core)

5. For the shape shown, find a single vector which is equal to

- (a) $\mathbf{AB} + \mathbf{BC}$
- (b) $\mathbf{AD} + \mathbf{DB}$
- (c) $\mathbf{AC} + \mathbf{CD}$
- (d) $\mathbf{BC} + \mathbf{CD} + \mathbf{DA}$
- (e) $\mathbf{CD} + \mathbf{DA} + \mathbf{AB} + \mathbf{BC}$

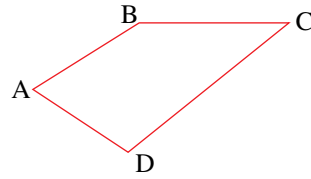

6. Consider the parallelogram shown alongside. Which of the following statements are true?

- (a) $\mathbf{AB} = \mathbf{DC}$
- (b) $|a| = |b|$
- (c) $\mathbf{BC} = \mathbf{b}$
- (d) $|\mathbf{AC} + \mathbf{CD}| = |b|$
- (e) $\mathbf{AD} = \mathbf{CB}$

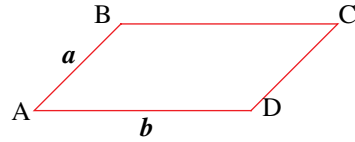

7. For each of the following

- i. complete the diagram by drawing the vector $\mathbf{AB} + \mathbf{BC}$.
- ii. find $|\mathbf{AB} + \mathbf{BC}|$.

(a)

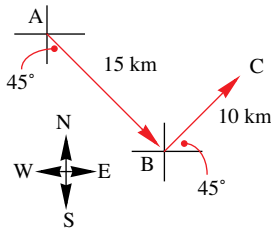

(b)

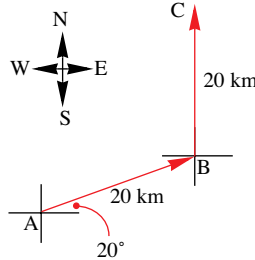

(c)

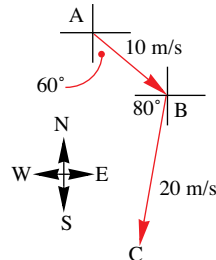

8. Two forces, one of 40 Newtons acting in a Northerly direction and one of 60 Newtons acting in an Easterly direction, are applied at a point A. Draw a vector diagram representing the forces. What is the resulting force at A?

9. Two trucks, on opposite sides of a river, are used to pull a barge along a straight river. They are connected to the barge at one point by ropes of equal length. The angle between the two ropes is 50° . Each truck is pulling with a force of 1500 Newtons.

- (a) Draw a vector diagram representing this situation.
- (b) Find the magnitude and direction of the force acting on the barge.

10. An aircraft is flying at 240 km/h in a Northerly direction when it encounters a 40 km/h wind from

- i. the North.
- ii. the North-East.

- (a) Draw a vector diagram representing these situations.
- (b) In each case, find the actual speed and direction of the aircraft.

11. Patrick walks for 200 m to point P due East of his cabin at point O, then 300 m due North where he reaches a vertical cliff, point Q. Patrick then climbs the 80 m cliff to point R.

- (a) Draw a vector diagram showing the vectors \mathbf{OP} , \mathbf{PQ} and \mathbf{QR} .
- (b) Find
 - i. $|\mathbf{OQ}|$
 - ii. $|\mathbf{OR}|$

26.3 ALGEBRA AND GEOMETRY OF VECTORS

26.3.1 ADDITION OF VECTORS

We have already had an ‘informal’ look at the addition of vectors in §26.2.5. We now take this a step further.

The vector sum of two vectors \mathbf{a} and \mathbf{b} is given by the unique vector \mathbf{c} (also known as the resultant) by using the **Triangle Law of Addition** or the **Parallelogram Law of Addition**.

Triangle Law of Addition

Method:

1. Vector \mathbf{b} is translated so that its tail coincides with the head of vector \mathbf{a} .
2. Then, the vectors sum of \mathbf{a} and \mathbf{b} is the vector \mathbf{c} which closes the triangle.

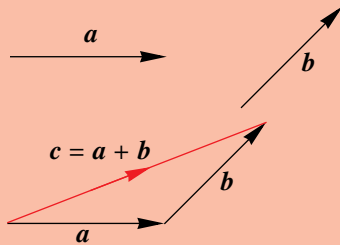

Parallelogram Law of Addition

Method:

1. Vector \mathbf{b} is translated so that its tail coincides with the tail of vector \mathbf{a} .
2. The vectors \mathbf{a} and \mathbf{b} then form adjacent sides of a parallelogram, so that their sum, vector \mathbf{c} , is represented by the diagonal as shown.

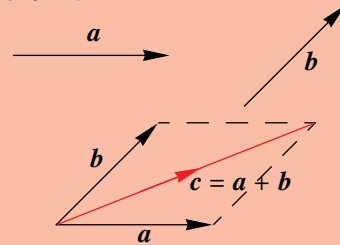

It should be noted:

1. $|\mathbf{a} + \mathbf{b}|$ does not necessarily equal $|\mathbf{a}| + |\mathbf{b}|$. In fact, $|\mathbf{a} + \mathbf{b}| \leq |\mathbf{a}| + |\mathbf{b}|$ – which is known as the Triangle Inequality.

Under what circumstances will $|\mathbf{a} + \mathbf{b}| = |\mathbf{a}| + |\mathbf{b}|$?

2. Properties of vector addition

Closure

Since $\mathbf{a} + \mathbf{b}$ is a vector, the operation of vector addition is **closed**.

Commutative

$$\mathbf{a} + \mathbf{b} = \mathbf{b} + \mathbf{a}$$

Associative

$$(\mathbf{a} + \mathbf{b}) + \mathbf{c} = \mathbf{a} + (\mathbf{b} + \mathbf{c})$$

Additive identity

There exists a unique zero vector, $\mathbf{0}$ (identity vector under addition), such that $\mathbf{a} + \mathbf{0} = \mathbf{0} + \mathbf{a} = \mathbf{a}$.

Additive Inverse

The inverse vector under addition is that vector which, when added to any vector, gives the zero vector. For any vector \mathbf{a} then, the vector $-\mathbf{a}$ (the negative of \mathbf{a}) is called the additive inverse of \mathbf{a} , so that

$$\mathbf{a} + (-\mathbf{a}) = (-\mathbf{a}) + \mathbf{a} = \mathbf{0}$$

26.3.2 SUBTRACTION OF VECTORS

Using the properties of vector addition we are now in a position to define the difference $a - b$ of two vectors a and b . Rather than subtracting vector b from vector a , we add vector $-b$ to vector a .

That is,

$$a - b = a + (-b)$$

Therefore, to subtract vector b from vector a we reverse the direction of vector b and then add it to vector a according to the triangle law (or parallelogram law):

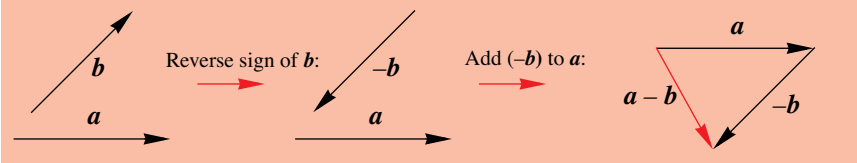

26.3.3 MULTIPLICATION OF VECTORS BY SCALARS

Multiplication of a vector by a scalar is best seen as the repeated use of the addition of the same vector. That is, the vector $a + a$, is by definition a vector having the same direction as a but twice its length and so, we can write $a + a$ as $2a$. We can then extend this to $a + a + a = 2a + a = 3a$ so that the vector $3a$ is a vector in the same direction as a but three times its magnitude. The process can then be continued indefinitely. Notice then that this is not restricted to integer multiples.

Similarly the vector $\frac{1}{2}a$ can be seen as representing a vector in the same direction as a but having half its magnitude. Geometrically we then have:

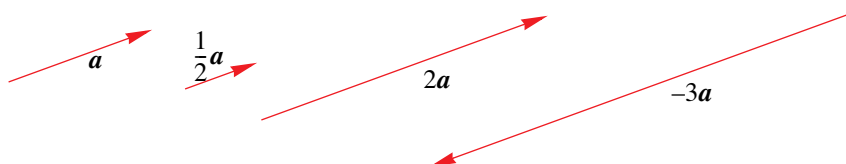

We can formalise scalar multiplication as follows:

For any scalar k , the product ka is a vector parallel to a whose magnitude is $|k|$ times that of a . i.e., $|ka| = |k||a|$.

In particular,

1. if $k > 0$ then ka and a have the same direction.
2. if $k < 0$ then ka and a are in opposite direction.
3. if $k = 0$ then $ka = \mathbf{0}$, the zero vector.

It should be noted:

1. From the above definition, we can restate the condition for two vectors to be parallel:

i.e., $a \parallel b$ if $a = kb$

Where, a and b are in the same direction if $k > 0$ (i.e., parallel) and in opposite directions if $k < 0$ (i.e., anti-parallel).

2. **Properties of multiplication by a scalar**

Closure

Since ka is a vector, multiplication by a scalar is closed.

Commutative $a \times k = k \times a$

Associative $(k \times m)a = k \times (ma)$

Distributive

- $(k + m)a = ka + ma$
- $k(a + b) = ka + kb$

Geometrically, the distributive properties can be seen as follows:

1. $(k + m)a = ka + ma$

2. $k(a + b) = ka + kb$

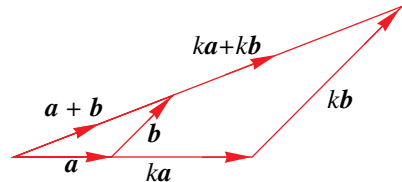
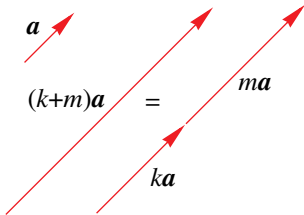

26.3.4 ANGLE BETWEEN VECTORS

For the vectors $a = \mathbf{OA}$ and $b = \mathbf{OB}$, the **angle between** the vectors a and b , θ , is given by the angle AOB , and is taken to be positive when measured in an anticlockwise direction.

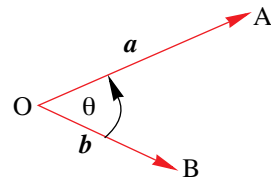

Note then that to find such an angle, the **vectors must first be joined tail to tail**.

26.3.5 APPLICATIONS TO GEOMETRY

As already seen in §26.2 vectors have clear applications to problems that involve geometry and trigonometry. In this section we concentrate on how the operations on vectors defined so far can be used to prove geometrical properties. Unlike geometric proofs encountered in the earlier years of schooling, vectors may be used very neatly to prove many of these theorems. We shall illustrate this by means of several examples.

EXAMPLE 26.3

Using the vectors shown, draw the vector diagrams showing

- (a) $a + 2b$ (b) $-a + \frac{1}{2}b$ (c) $3a - 2b$

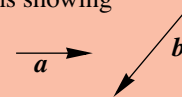

S
o
l
u
t
i
o
n

- (a) We first need the vector $2b$ and then we add it to the vector a .

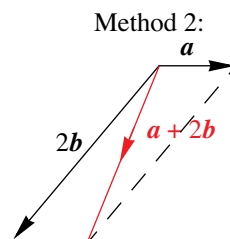
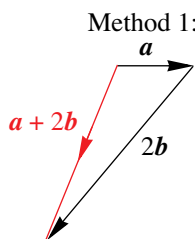
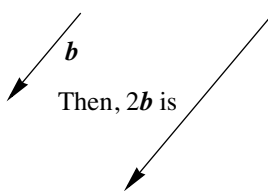

- (b) This time we need the vectors $-a$ and $\frac{1}{2}b$

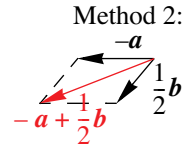
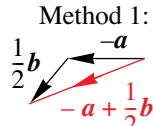
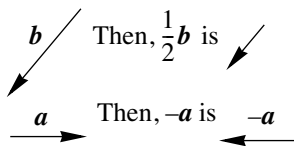

- (c) For this problem we need the vectors $3a$ and $-2b$.

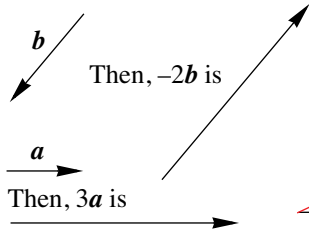

Method 1:

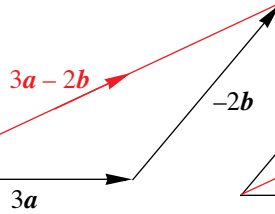

Method 2:

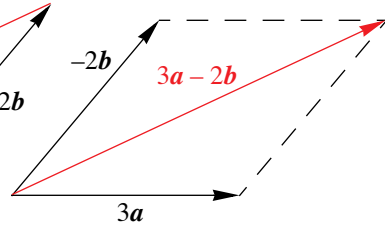

EXAMPLE 26.4

The rectangle OABC is such that $OA = 8$, $AB = 6$ and $\mathbf{OA} = \mathbf{a}$ and $\mathbf{OC} = \mathbf{b}$.

- (a) Express the two diagonals in terms of \mathbf{a} and \mathbf{b} .
 (b) Find i. $|\mathbf{OB}|$ ii. $|\mathbf{OB} + \mathbf{CA}|$.
 (c) Find $\mathbf{OA} + \mathbf{AC} + \mathbf{CO}$.

S
o
l
u
t
i
o
n

- (a) We start by drawing the figure under discussion:

The diagonals are: $\mathbf{OB} = \mathbf{OA} + \mathbf{AB}$
 $= \mathbf{OA} + \mathbf{OC}$
 $= \mathbf{a} + \mathbf{b}$

and

$$\begin{aligned} \mathbf{AC} &= \mathbf{AB} + \mathbf{BC} \\ &= \mathbf{OC} + (-\mathbf{CB}) \\ &= \mathbf{OC} + (-\mathbf{OA}) \\ &= \mathbf{b} - \mathbf{a} \end{aligned}$$

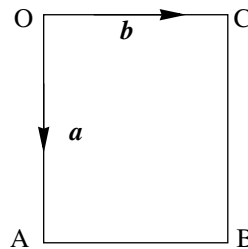

- (b) i. $|\mathbf{OB}| = \sqrt{|\mathbf{OC}|^2 + |\mathbf{CB}|^2} = \sqrt{8^2 + 6^2} = 10$ [using Pythagoras's Theorem]

ii. $\mathbf{OB} + \mathbf{CA} = (\mathbf{OC} + \mathbf{CB}) + (\mathbf{CO} + \mathbf{OA})$
 $= (\mathbf{OC} + \mathbf{CO}) + \mathbf{CB} + \mathbf{OA}$
 $= (\mathbf{OC} + (-\mathbf{OC})) + \mathbf{a} + \mathbf{a}$
 $= (\mathbf{0}) + 2\mathbf{a}$
 $= 2\mathbf{a}$

$$\therefore |\mathbf{OB} + \mathbf{CA}| = |2\mathbf{a}| = 2|\mathbf{a}| = 2 \times 8 = 16$$

- (c) $\mathbf{OA} + \mathbf{AC} + \mathbf{CO} = \mathbf{OA} + (\mathbf{AO} + \mathbf{OC}) + \mathbf{CO}$
 $= (\mathbf{OA} + \mathbf{AO}) + (\mathbf{OC} + \mathbf{CO})$
 $= \mathbf{0} + \mathbf{0}$
 $= \mathbf{0}$

Notice that in Example 26.4 we consistently kept re-expressing the diagonals in terms of the sides of the rectangle. In fact you will find that for many problems that involve geometric shapes, it helps to express vectors in terms of the sides of the shape under discussion.

EXAMPLE 26.5

Simplify the following expressions

- (a) $\mathbf{AB} + \mathbf{BC} + \mathbf{DE} + \mathbf{CD}$
 (b) $2\mathbf{AB} + 4\mathbf{AC} + 4\mathbf{BA} + 6\mathbf{CD} + 2\mathbf{DA} + 2\mathbf{DC}$

S
o
l
u
t
i
o
n

- (a) In this case we have no given shape to make reference to, however, we can still simplify the sum by referring to the head and tail of each vector and ‘grouping’ a head to a corresponding tail:

$$\begin{aligned} \mathbf{AB} + \mathbf{BC} + \mathbf{DE} + \mathbf{CD} &= \mathbf{AB} + \mathbf{BC} + \mathbf{CD} + \mathbf{DE} \text{ [rearranging]} \\ &= \mathbf{AC} + \mathbf{CE} \text{ [grouping]} \\ &= \mathbf{AE} \end{aligned}$$

That is, when adding \mathbf{AB} and \mathbf{BC} we observe that one vector ends at B while the second starts from B, this becomes a common point and so we ‘group’ those two vectors, then we complete the triangle ABC, i.e., $\mathbf{AB} + \mathbf{BC} = \mathbf{AC}$.

- (b) $2\mathbf{AB} + 4\mathbf{AC} + 4\mathbf{BA} + 6\mathbf{CD} + 2\mathbf{DA} + 2\mathbf{DC}$
 $= 2\mathbf{AB} + 4\mathbf{BA} + 4\mathbf{AC} + 6\mathbf{CD} + 2\mathbf{DA} + 2\mathbf{DC}$
 $= 2\mathbf{AB} + 2\mathbf{BA} + 2\mathbf{BA} + 4\mathbf{AC} + 4\mathbf{CD} + 2\mathbf{CD} + 2\mathbf{DA} + 2\mathbf{DC}$
 $= 2\mathbf{AB} - 2\mathbf{AB} + 2\mathbf{BA} + 4(\mathbf{AC} + \mathbf{CD}) + 2(\mathbf{CD} + \mathbf{DC}) + 2\mathbf{DA}$
 $= \mathbf{0} + 2\mathbf{BA} + 4\mathbf{AD} + 2(\mathbf{0}) + 2\mathbf{DA}$
 $= 2\mathbf{BA} + 2\mathbf{AD} + 2\mathbf{AD} + 2\mathbf{DA}$
 $= 2(\mathbf{BA} + \mathbf{AD}) + 2(\mathbf{DA} + \mathbf{AD})$
 $= 2\mathbf{BD} + 2(\mathbf{0})$
 $= 2\mathbf{BD}$

EXAMPLE 26.6

Prove that the line segment joining the mid-points of two sides of a triangle is parallel to the third side and half its length.

S
o
l
u
t
i
o
n

Consider the triangle ABC where D and E are the mid-points of \overline{AC} and \overline{BC} respectively.

We then need to express \mathbf{DE} in terms of \mathbf{AB} .

First we note that $\mathbf{DC} = \frac{1}{2}\mathbf{AC}$ and $\mathbf{CE} = \frac{1}{2}\mathbf{CB}$.

Then, we have $\mathbf{DE} = \mathbf{DC} + \mathbf{CE}$

$$\begin{aligned} &= \frac{1}{2}\mathbf{AC} + \frac{1}{2}\mathbf{CB} \\ &= \frac{1}{2}(\mathbf{AC} + \mathbf{CB}) \\ &= \frac{1}{2}\mathbf{AB} \end{aligned}$$

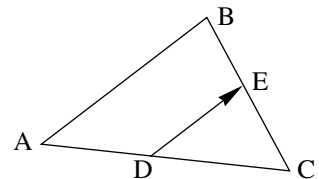

Now, as $\mathbf{DE} = \frac{1}{2}\mathbf{AB}$ we can make two observations

1. $\mathbf{DE} \parallel \mathbf{AB}$
2. $|\mathbf{DE}| = \frac{1}{2}|\mathbf{AB}|$, i.e., \mathbf{DE} is half the length of \mathbf{AB} .

Hence we have shown that the line segment joining the mid-points of two sides of a triangle is parallel to the third side and half its length.

EXAMPLE 26.7

Prove that if one pair of opposite sides of a quadrilateral is equal and parallel, then the quadrilateral is a parallelogram.

Solution Start by drawing a random quadrilateral, i.e., one without any pre-conceived properties. The reason we do this is because had we drawn two opposite sides as being equal and parallel then we would have a parallelogram and then, we might make assumptions during our proof (assumptions that we are trying to prove!)

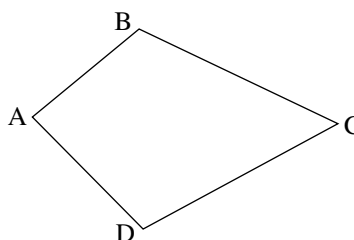

Consider the quadrilateral ABCD as shown:

From the information given, we have that $\mathbf{AB} = \mathbf{DC}$.

Note that we could have chosen any two sides to be parallel and equal (even though the diagram does not reflect this).

$$\begin{aligned} \text{Now,} \quad \mathbf{AD} &= \mathbf{AB} + \mathbf{BD} \\ &= \mathbf{DC} + \mathbf{BD} \text{ [since } \mathbf{AB} = \mathbf{DC}] \\ &= \mathbf{BD} + \mathbf{DC} \text{ [rearranging terms]} \\ &= \mathbf{BC} \end{aligned}$$

That is, we have shown that $\mathbf{AD} = \mathbf{BC}$, meaning that the other two sides of the quadrilateral are equal in length and parallel. Then, by definition, the quadrilateral is a parallelogram.

EXAMPLE 26.8

Find the position vector of the point P which divides the line segment AB in the ratio $m:n$.

Solution As the problem makes reference to the position vector of point P we need to introduce an origin. Let O be this origin. Then, let $\mathbf{OA} = \mathbf{a}$, $\mathbf{OB} = \mathbf{b}$ and $\mathbf{OP} = \mathbf{p}$ where $AP:PB = m:n$.

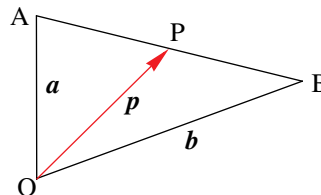

$$\begin{aligned} \text{Then, } \mathbf{OP} &= \mathbf{OA} + \mathbf{AP} = \mathbf{OA} + \frac{m}{m+n}\mathbf{AB} \\ &= \mathbf{a} + \frac{m}{m+n}(\mathbf{AO} + \mathbf{OB}) \\ &= \mathbf{a} + \frac{m}{m+n}(-\mathbf{a} + \mathbf{b}) \end{aligned}$$

$$\begin{aligned}
 \text{That is, } \mathbf{OP} &= \left(\frac{m+n}{m+n}\right)\mathbf{a} + \frac{m}{m+n}(-\mathbf{a} + \mathbf{b}) \\
 &= \frac{1}{m+n}(\mathbf{ma} + \mathbf{na} - \mathbf{ma} + \mathbf{mb}) \\
 &= \frac{1}{m+n}(\mathbf{na} + \mathbf{mb})
 \end{aligned}$$

EXAMPLE 26.9

Prove that the diagonals of a parallelogram bisect each other.

S
o
l
u
t
i
o
n

Consider the parallelogram OABC where $\mathbf{OA} = \mathbf{a}$ and $\mathbf{OC} = \mathbf{c}$. Let P be the mid-point of \overline{OB} and Q be the mid-point of \overline{AC} .

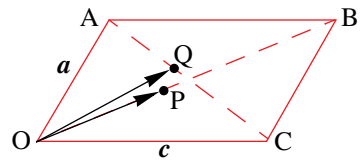

$$\begin{aligned}
 \mathbf{OQ} &= \mathbf{OA} + \mathbf{AQ} \quad [\text{Triangular Law of addition}] \\
 &= \mathbf{OA} + \frac{1}{2}\mathbf{AC} \quad [\text{Q is the mid-point of } \overline{AC}] \\
 &= \mathbf{a} + \frac{1}{2}(-\mathbf{a} + \mathbf{c}) \quad [\mathbf{AC} = \mathbf{AO} + \mathbf{OC} = -\mathbf{OA} + \mathbf{OC}]
 \end{aligned}$$

$$\therefore \mathbf{OQ} = \frac{1}{2}(\mathbf{a} + \mathbf{c}) \quad (1)$$

$$\begin{aligned}
 \text{Next, } \mathbf{OP} &= \frac{1}{2}\mathbf{OB} \quad [\text{P is the mid-point of } \overline{OB}] \\
 &= \frac{1}{2}(\mathbf{OC} + \mathbf{CB}) \quad [\text{Triangular Law of addition}]
 \end{aligned}$$

$$\therefore \mathbf{OP} = \frac{1}{2}(\mathbf{c} + \mathbf{a}) \quad (2)$$

From (1) and (2) $\mathbf{OP} = \mathbf{OQ}$ meaning that P and Q are the same point and so, as they are also the midpoints of the diagonals, this means that the diagonals of a parallelogram bisect each other.

EXERCISES 26.3

1. For the quadrilateral OABC, where $\mathbf{OA} = \mathbf{a}$, $\mathbf{OB} = \mathbf{b}$ and $\mathbf{OC} = \mathbf{c}$, find in terms of \mathbf{a} , \mathbf{b} and \mathbf{c} an expression for
- \mathbf{AC}
 - \mathbf{BC}
 - the mid-point of \overline{AB} relative to O

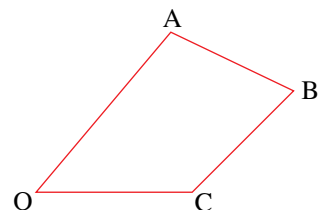

MATHEMATICS – Higher Level (Core)

2. Using the vectors shown below, draw the vectors

- (a) $a - b$
- (b) $b - 2a$
- (c) $2b - 3a$
- (d) $\frac{1}{2}(b + 2a)$

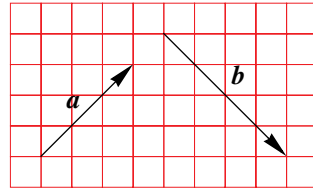

- 3.** Simplify
- (a) $\mathbf{WX} + \mathbf{XY} + \mathbf{YW}$
 - (b) $\mathbf{PQ} - \mathbf{SR} + \mathbf{QR}$
 - (c) $\mathbf{AX} - \mathbf{BX} + \mathbf{BZ} + \mathbf{YD} - \mathbf{YZ} - \mathbf{YD}$
 - (d) $3\mathbf{OA} + 6\mathbf{BC} + 2\mathbf{AO} + \mathbf{AB} + 5\mathbf{OB}$

4. Consider the triangle ABC whose vertices have position vectors a, b and c respectively. Find the position vector of

- (a) P, the mid-point of \overline{AB} .
- (b) Q, the point of trisection of \overline{AB} , with Q closer to B.
- (c) R, the mid-point of the median CP.

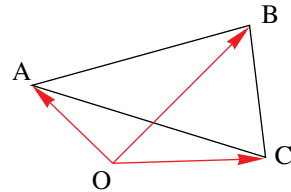

- 5.** Prove that
- (a) $\overrightarrow{AB} + \overrightarrow{BO} + \overrightarrow{OA} = \mathbf{0}$
 - (b) $\overrightarrow{XY} + \overrightarrow{YO} + \overrightarrow{OZ} + \overrightarrow{ZX} = \mathbf{0}$
 - (c) if $\overrightarrow{AO} + \overrightarrow{OB} = \overrightarrow{BO} + \overrightarrow{OC}$ then A, B, C are collinear

6. If M is the mid-point of \overline{AB} and N is the mid-point of \overline{CD} , show that $2\overline{MN} = \overline{AC} + \overline{BD}$.

7. Consider the cuboid ABCD, EFGH with vectors as shown on the diagram. Express, in terms of a, b and c the following:

- (a) \mathbf{BC}
- (b) \mathbf{AG}
- (c) \mathbf{BH}

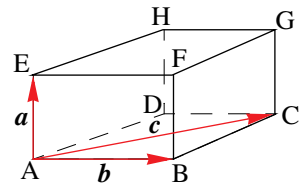

8. In question 7., $|a| = 2, |b| = 4$ and $|c| = 10$. Find (a) \mathbf{BC} (b) \mathbf{BH}

9. Prove that the sum of the vectors from the centre to the vertices of a regular hexagon is $\mathbf{0}$.

10. In the diagram alongside, P and Q are the mid-points of WY and XZ respectively.

Show that $4\overline{PQ} = \overline{WX} + \overline{WZ} + \overline{YX} + \overline{YZ}$.

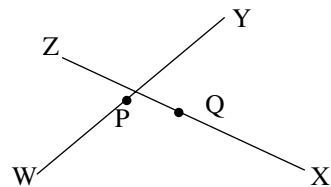

11. Show that the line segments joining the mid-points of the sides of any quadrilateral form a parallelogram.

12. Show that a quadrilateral whose diagonals bisect each other is a parallelogram.

13. A, B, C are the mid-points of the sides PQ, QR and RP respectively of the triangle PQR. Show that $\mathbf{OP} + \mathbf{OQ} + \mathbf{OR} = \mathbf{OA} + \mathbf{OB} + \mathbf{OC}$ where O is some origin.
14. Prove that
- A and B are coincident points if $\mathbf{MB} + \mathbf{NM} = \mathbf{NA} + \mathbf{BA}$.
 - A, B, C are collinear if $\mathbf{OC} = 3\mathbf{OB} - 2\mathbf{OA}$.
 - if ABCD is a quadrilateral then $\mathbf{AC} - \mathbf{BD} = \mathbf{AB} - \mathbf{CD}$.
15. If the vectors $\mathbf{a} = 2\mathbf{u} - 3\mathbf{v}$ and $\mathbf{b} = 5\mathbf{u} + 4\mathbf{v}$, find the scalars m and n such that $\mathbf{c} = m\mathbf{a} + n\mathbf{b}$ where $\mathbf{c} = 12\mathbf{u} + 7\mathbf{v}$ and \mathbf{u} and \mathbf{v} are non-parallel vectors.
16. Consider the parallelogram ABCD where the point P is such that AP:PD = 1:2 and \mathbf{BD} intersects \mathbf{CP} at Q where DQ:QB = 1:3. Find the scalar m if $\mathbf{CP} = m\mathbf{CQ}$.

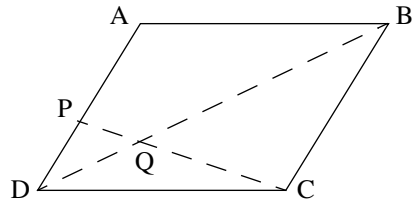

26.4 CARTESIAN REPRESENTATION OF VECTORS IN 2-D AND 3-D

26.4.1 REPRESENTATION IN 2-D

When describing vectors in two-dimensional space it is often helpful to make use of a rectangular Cartesian coordinate system.

As such, the position vector of the point P, \mathbf{OP} , has the coordinates (x, y) .

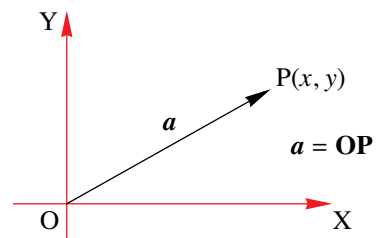

The vector \mathbf{a} can be expressed as a **column vector** $\begin{pmatrix} x \\ y \end{pmatrix}$. That is,

$\mathbf{a} = \begin{pmatrix} x \\ y \end{pmatrix}$ is the position vector \mathbf{OP} where P has the coordinates (x, y) .

26.4.2 UNIT VECTOR AND BASE VECTOR NOTATION

We define the unit vector $\mathbf{i} = \begin{pmatrix} 1 \\ 0 \end{pmatrix}$ as the position vector of the point having coordinates $(1, 0)$,

and the unit vector $\mathbf{j} = \begin{pmatrix} 0 \\ 1 \end{pmatrix}$ as the position vector of the point having coordinates $(0, 1)$.

The term **unit vector** refers to the fact that the vector **has a magnitude of one**.

$$\mathbf{a} = \begin{pmatrix} x \\ y \end{pmatrix} = \begin{pmatrix} x \\ 0 \end{pmatrix} + \begin{pmatrix} 0 \\ y \end{pmatrix} = x \begin{pmatrix} 1 \\ 0 \end{pmatrix} + y \begin{pmatrix} 0 \\ 1 \end{pmatrix} = xi + yj$$

i.e., the position vector of any point can be expressed as the sum of two vectors, one parallel to the x -axis and one parallel to the y -axis.

The unit vectors i and j are also known as the **base vectors**.

If we confine ourselves to vectors that exist in the plane of this page, the most commonly used basis is:

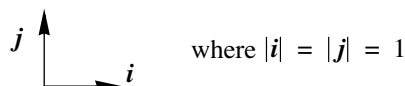

Notice the definite direction of the base vectors, i.e., i points in the positive x -axis direction while j points in the positive y -axis direction.

Vectors can now be expressed in terms of these base vectors.

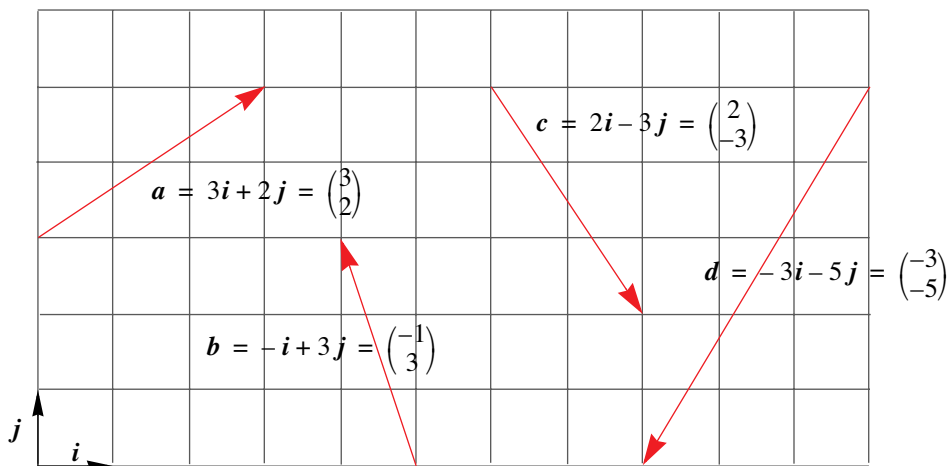

The vector a is ‘three steps to the right and two steps up’ and can be written in terms of the standard basis as $a = 3i + 2j$.

The vector b is ‘one step to the left and three steps up’. ‘One step to the left’ is in the opposite direction of the basis element i and is written $-i$, giving the definition of the vector $b = -i + 3j$. The vectors $-i$ and $3j$ are known as **components** of the vector b .

The other definitions follow in a similar way.

26.4.3 REPRESENTATION IN 3-D

When vectors are represented in three dimensional space, a third vector must be added to the basis, in this case it is a unit vector k and is such that the three unit vectors are mutually perpendicular as shown.

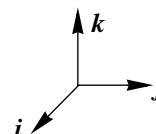

In addition, extra basis vectors can be added to generate higher dimensional vector spaces. These may not seem relevant to us, inhabiting as we do, a three dimensional space. However, it remains the case that it is possible to do calculations in higher dimensional spaces and these have produced many valuable results for applied mathematicians.

As was the case for vectors in two dimensions, we can represent vectors in three dimensions using column vectors as follows:

The position vector $\mathbf{a} = \mathbf{OP}$ where P has coordinates (x, y, z) is given by

$$\mathbf{a} = \begin{pmatrix} x \\ y \\ z \end{pmatrix} = \begin{pmatrix} x \\ 0 \\ 0 \end{pmatrix} + \begin{pmatrix} 0 \\ y \\ 0 \end{pmatrix} + \begin{pmatrix} 0 \\ 0 \\ z \end{pmatrix} = x \begin{pmatrix} 1 \\ 0 \\ 0 \end{pmatrix} + y \begin{pmatrix} 0 \\ 1 \\ 0 \end{pmatrix} + z \begin{pmatrix} 0 \\ 0 \\ 1 \end{pmatrix} = x\mathbf{i} + y\mathbf{j} + z\mathbf{k}$$

Where this time the base vectors are

$$\mathbf{i} = \begin{pmatrix} 1 \\ 0 \\ 0 \end{pmatrix}, \mathbf{j} = \begin{pmatrix} 0 \\ 1 \\ 0 \end{pmatrix} \text{ and } \mathbf{k} = \begin{pmatrix} 0 \\ 0 \\ 1 \end{pmatrix}$$

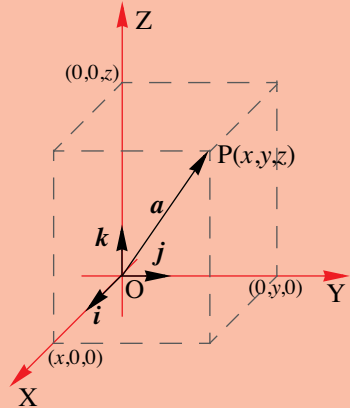

26.4.4 VECTOR OPERATIONS

Addition and Subtraction

If $\mathbf{a} = \begin{pmatrix} x_1 \\ y_1 \end{pmatrix} = x_1\mathbf{i} + y_1\mathbf{j}$ and $\mathbf{b} = \begin{pmatrix} x_2 \\ y_2 \end{pmatrix} = x_2\mathbf{i} + y_2\mathbf{j}$ then

$$\mathbf{a} \pm \mathbf{b} = \begin{pmatrix} x_1 \\ y_1 \end{pmatrix} \pm \begin{pmatrix} x_2 \\ y_2 \end{pmatrix} = \begin{pmatrix} x_1 \pm x_2 \\ y_1 \pm y_2 \end{pmatrix} = (x_1 \pm x_2)\mathbf{i} + (y_1 \pm y_2)\mathbf{j}$$

If $\mathbf{a} = \begin{pmatrix} x_1 \\ y_1 \\ z_1 \end{pmatrix} = x_1\mathbf{i} + y_1\mathbf{j} + z_1\mathbf{k}$ and $\mathbf{b} = \begin{pmatrix} x_2 \\ y_2 \\ z_2 \end{pmatrix} = x_2\mathbf{i} + y_2\mathbf{j} + z_2\mathbf{k}$ then

$$\mathbf{a} \pm \mathbf{b} = \begin{pmatrix} x_1 \\ y_1 \\ z_1 \end{pmatrix} \pm \begin{pmatrix} x_2 \\ y_2 \\ z_2 \end{pmatrix} = \begin{pmatrix} x_1 \pm x_2 \\ y_1 \pm y_2 \\ z_1 \pm z_2 \end{pmatrix} = (x_1 \pm x_2)\mathbf{i} + (y_1 \pm y_2)\mathbf{j} + (z_1 \pm z_2)\mathbf{k}$$

Scalar Multiplication

If $\mathbf{a} = \begin{pmatrix} x \\ y \end{pmatrix} = x\mathbf{i} + y\mathbf{j}$ then $k\mathbf{a} = k \begin{pmatrix} x \\ y \end{pmatrix} = \begin{pmatrix} kx \\ ky \end{pmatrix} = kx\mathbf{i} + ky\mathbf{j}, k \in \mathbb{R}.$

If $\mathbf{a} = \begin{pmatrix} x \\ y \\ z \end{pmatrix} = x\mathbf{i} + y\mathbf{j} + z\mathbf{k}$ then $k\mathbf{a} = k \begin{pmatrix} x \\ y \\ z \end{pmatrix} = \begin{pmatrix} kx \\ ky \\ kz \end{pmatrix} = kx\mathbf{i} + ky\mathbf{j} + kz\mathbf{k}, k \in \mathbb{R}$

EXAMPLE 26.10

If $a = 2i - j$ and $b = -i + 3j$, find:

- (a) $a + b$ (b) $b - a$ (c) $3b - 2a$

S
O
L
I
T
I
O
N

Vectors are added ‘nose to tail’:

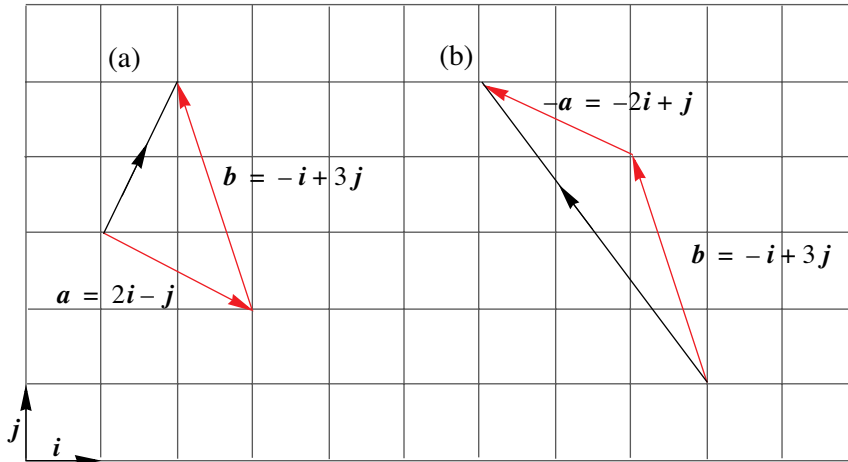

- (a) Vectors are added in much the same way as are algebraic terms. Only like terms can be added or subtracted, so that

$$\begin{aligned} a + b &= (2i - j) + (-i + 3j) \\ &= (2 - 1)i + (-1 + 3)j \\ &= i + 2j \end{aligned}$$

- (b) This problem is solved in a similar way:

$$\begin{aligned} b - a &= (-i + 3j) - (2i - j) \\ &= (-1 - 2)i + (3 - (-1))j \\ &= -3i + 4j \end{aligned}$$

Note that we could also have expressed the sum as $b - a = b + (-a) = (-i + 3j) + (-2i + j)$.
 $= -3i + 4j$

(i.e., the negative of a vector is the same length as the original vector but points in the opposite direction.)

- (c) Combining the properties of scalar multiplication with those of addition and subtraction we have

$$\begin{aligned} 3b - 2a &= 3(-i + 3j) - 2(2i - j) \\ &= -3i + 9j - 4i + 2j \\ &= -7i + 11j \end{aligned}$$

EXAMPLE 26.11

If $p = \begin{pmatrix} 3 \\ -1 \\ 4 \end{pmatrix}$ and $q = \begin{pmatrix} -2 \\ 0 \\ 3 \end{pmatrix}$, find:

- (a) $p + q$ (b) $p - \frac{q}{2}$ (c) $\frac{3}{2}q - p$

S
o
l
u
t
i
o
n

(a)

$$p + q = \begin{pmatrix} 3 \\ -1 \\ 4 \end{pmatrix} + \begin{pmatrix} -2 \\ 0 \\ 3 \end{pmatrix} = \begin{pmatrix} 3-2 \\ -1+0 \\ 4+3 \end{pmatrix} = \begin{pmatrix} 1 \\ -1 \\ 7 \end{pmatrix}$$

(b)

$$p - \frac{q}{2} = \begin{pmatrix} 3 \\ -1 \\ 4 \end{pmatrix} - \frac{1}{2} \begin{pmatrix} -2 \\ 0 \\ 3 \end{pmatrix} = \begin{pmatrix} 3+1 \\ -1-0 \\ 4-1.5 \end{pmatrix} = \begin{pmatrix} 4 \\ -1 \\ 2.5 \end{pmatrix}$$

(c)

$$\frac{3}{2}q - p = 1.5 \begin{pmatrix} -2 \\ 0 \\ 3 \end{pmatrix} - \begin{pmatrix} 3 \\ -1 \\ 4 \end{pmatrix} = \begin{pmatrix} -3-3 \\ 0+1 \\ 4.5-4 \end{pmatrix} = \begin{pmatrix} -6 \\ 1 \\ 0.5 \end{pmatrix}$$

EXAMPLE 26.12

A surveyor is standing at the top of a hill. Call this point ‘the origin’ (O). A lighthouse (L) is visible 4km to the West and 3km to the North. A town (T) is visible 5km to the South and 2km to the East. Using a vector basis in which i is a 1km vector running East and j is a 1km vector running North. Find the position vectors of the lighthouse, \vec{OL} and the town \vec{OT} . Hence find the vector \vec{LT} and the position of the town relative to the lighthouse.

S
o
l
u
t
i
o
n

The position vectors are: Lighthouse $\vec{OL} = -4i + 3j$ and Town $\vec{OT} = 2i - 5j$.

$$\begin{aligned} \text{Then, to get from L to T we have } \vec{LT} &= \vec{LO} + \vec{OT} \\ &= -\vec{OL} + \vec{OT} \\ &= -(-4i + 3j) + (2i - 5j) \\ &= 4i - 3j + 2i - 5j \\ &= 6i - 8j \end{aligned}$$

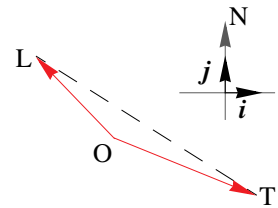

This means that the town is 6km East of the lighthouse and 8km South.

EXERCISES 26.4

1. If $a = i + 7j - k$ and $b = 4i + 7j + 5k$ find:

(i) $4a$ (ii) $3b$ (iii) $2a - b$ (iv) $2(a - b)$

2. The position vectors of A and B are $\vec{OA} = -3i + 4j - 2k$ and $\vec{OB} = i - 4j - 3k$. Find:

(i) \vec{AO} (ii) $\vec{OA} - 5\vec{OB}$ (iii) $-5\vec{OA} + 3\vec{OB}$ (iv) $3\vec{OA} + 6\vec{BO}$

MATHEMATICS – Higher Level (Core)

3. The vectors \mathbf{p} and \mathbf{q} are defined by $\mathbf{p} = \begin{pmatrix} -1 \\ -2 \\ 4 \end{pmatrix}$ and $\mathbf{q} = \begin{pmatrix} 6 \\ 1 \\ 2 \end{pmatrix}$. Find:

(i) $\mathbf{p} + 2\mathbf{q}$ (ii) $-3\mathbf{p} - 5\mathbf{q}$ (iii) $3\mathbf{p}$ (iv) $2\mathbf{p} + 3\mathbf{q}$

4. Find the position vectors that join the origin to the points with coordinates A (2,-1) and B (-3,2). Express your answers as column vectors. Hence find \overrightarrow{AB}

5. A point on the Cartesian plane starts at the origin. The point then moves 4 units to the right, 5 units up, 6 units to the left and, finally 2 units down. Express these translations as a sum of four column vectors. Hence find the coordinates of the final position of the point.

6. Two vectors are defined as $\mathbf{a} = \mathbf{i} + \mathbf{j} + 4\mathbf{k}$ and $\mathbf{b} = -7\mathbf{i} - \mathbf{j} + 2\mathbf{k}$. Find:

(i) $-6\mathbf{a} - 2\mathbf{b}$ (ii) $-5\mathbf{a} + 2\mathbf{b}$ (iii) $4\mathbf{a} + 3\mathbf{b}$ (iv) $-2(\mathbf{a} + 3\mathbf{b})$

7. If $\mathbf{x} = \begin{pmatrix} 4 \\ -4 \\ 2 \end{pmatrix}$ and $\mathbf{y} = \begin{pmatrix} 4 \\ 3 \\ 7 \end{pmatrix}$, express the following as column vectors.

(i) $2\mathbf{x} + 3\mathbf{y}$ (ii) $\mathbf{x} + 2\mathbf{y}$ (iii) $5\mathbf{x} - 6\mathbf{y}$ (iv) $\mathbf{x} - 6\mathbf{y}$

8. Find the values of A and B if $A(7\mathbf{i} + 7\mathbf{j} + 4\mathbf{k}) - 3(3\mathbf{i} - \mathbf{j} + B\mathbf{k}) = -37\mathbf{i} - 25\mathbf{j} + 5\mathbf{k}$

9. Two vectors are defined as $\mathbf{a} = \begin{pmatrix} -3 \\ 1 \\ 4 \end{pmatrix}$ and $\mathbf{b} = \begin{pmatrix} 6 \\ -6 \\ -5 \end{pmatrix}$. Find values of the scalars X and

Y if $X\mathbf{a} + Y\mathbf{b}$ is equal to: (i) $\begin{pmatrix} -36 \\ 32 \\ 33 \end{pmatrix}$ (ii) $\begin{pmatrix} 30 \\ -22 \\ -31 \end{pmatrix}$ (iii) $\begin{pmatrix} -12 \\ 24 \\ 1 \end{pmatrix}$

10. A submarine (which is considered the origin of the vector system) is 60 metres below the surface of the sea when it detects two surface ships. A destroyer (D) is 600 metres to the East and 800 metres to the South of the submarine. An aircraft carrier (A) is 1200 metres to the West and 300 metres to the South.

- (a) Define a suitable vector basis for this problem.
- (b) Using the submarine as the origin, state the position vectors of the destroyer and the aircraft carrier.
- (c) A helicopter pilot, based on the aircraft carrier wants to make a supplies delivery to the destroyer. Find, in vector terms, the course along which the pilot should fly.

26.5 FURTHER PROPERTIES OF VECTORS IN 2-D AND 3-D

26.5.1 MAGNITUDE OF A VECTOR

If a vector is expressed in terms of the unit length basis of vectors, i, j, k , the **length** of the vector can be found using the Theorem of Pythagoras.

The length of a vector is sometimes known as its **magnitude** or **absolute value**. The length of a vector a is often represented by $|a|$. If the vector represents some physical quantity such as a force, the length of the vector is the size of the force, without its direction. The length of a vector is a scalar quantity.

The magnitude of a vector can be found by applying Pythagoras's Theorem in the case of vectors in two dimensions and repeated use of Pythagoras's Theorem in the case of vectors in three dimensions.

The magnitude of a vector

$$a = \begin{pmatrix} x \\ y \end{pmatrix} = xi + yj$$

is given by $|a| = \sqrt{x^2 + y^2}$.

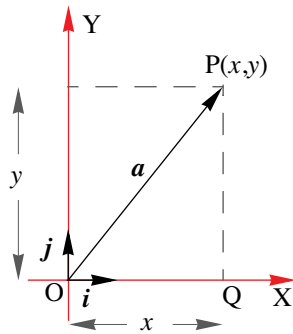

PROOF:

$$|OP|^2 = |OQ|^2 + |QP|^2$$

$$\therefore |a|^2 = x^2 + y^2$$

$$\therefore |a| = \sqrt{x^2 + y^2}, (|a| > 0)$$

The magnitude of a vector

$$a = \begin{pmatrix} x \\ y \\ z \end{pmatrix} = xi + yj + zk$$

is given by $|a| = \sqrt{x^2 + y^2 + z^2}$.

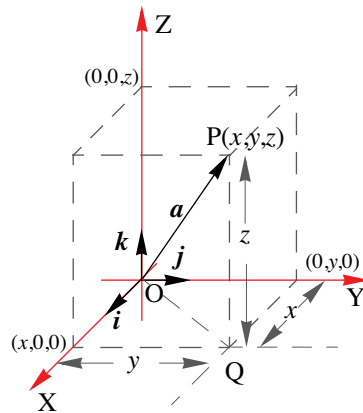

$$|OP|^2 = |OQ|^2 + |QP|^2$$

$$\therefore |a|^2 = (x^2 + y^2) + z^2$$

$$\therefore |a| = \sqrt{x^2 + y^2 + z^2}, (|a| > 0)$$

EXAMPLE 26.13

Find the lengths of the vectors:

- (a) $3i - 4j$ (b) $-i + 2j - 5k$ (c) $\begin{pmatrix} 3 \\ -1 \\ 2 \end{pmatrix}$

S
o
l
u
t
i
o
n

(a) The vector $3\mathbf{i} - 4\mathbf{j}$ is represented by the diagram:

$$\begin{aligned} |3\mathbf{i} - 4\mathbf{j}| &= \sqrt{3^2 + (-4)^2} \\ &= \sqrt{9 + 16} \\ &= \sqrt{25} \\ &= 5 \end{aligned}$$

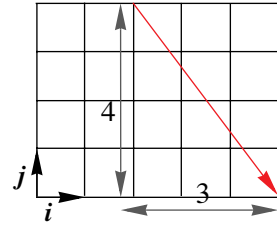

(b) $|-i + 2j - 5k| = \sqrt{(-1)^2 + 2^2 + (-5)^2} = \sqrt{30}$

(c) $\left| \begin{pmatrix} 3 \\ -1 \\ 2 \end{pmatrix} \right| = \sqrt{3^2 + (-1)^2 + 2^2} = \sqrt{14}$

26.5.2 UNIT VECTORS

The **unit vector**, as the name implies, is a vector having a magnitude (length) of one unit. We use the notation \hat{a} , read as “*a hat*”. Then, \hat{a} is a vector of length one unit in the same direction as a .

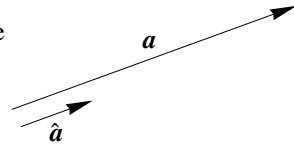

For example, if we had a vector r of length four units, to find the corresponding unit vector, \hat{r} , we would need to divide the vector r by four, resulting in a vector parallel to r but of unit length.

We then have the definition that

$$\hat{a} = \frac{a}{|a|}$$

EXAMPLE 26.14

Find unit vectors in the same directions as the vectors:

(a) $5\mathbf{i} - 2\mathbf{j}$ (b) $\begin{pmatrix} -3 \\ 6 \\ 4 \end{pmatrix}$

S
o
l
u
t
i
o
n

(i) $|5\mathbf{i} - 2\mathbf{j}| = \sqrt{5^2 + (-2)^2} = \sqrt{29}$. This is the length of the vector. In order to produce a vector of unit length, we can keep the original components of the vector, scaling them down to produce the required unit vector: $\frac{1}{\sqrt{29}}(5\mathbf{i} - 2\mathbf{j})$

(ii) $\left| \begin{pmatrix} -3 \\ 6 \\ 4 \end{pmatrix} \right| = \sqrt{(-3)^2 + 6^2 + 4^2} = \sqrt{61}$ The required unit vector is: $\frac{1}{\sqrt{61}} \begin{pmatrix} -3 \\ 6 \\ 4 \end{pmatrix}$.

EXAMPLE 26.15

 Find a vector of length 10 units in the direction of $2\mathbf{i} - 3\mathbf{j} + \mathbf{k}$.

**S
o
l
u
t
i
o
n**

$$\begin{aligned} \text{Let } \mathbf{u} = 2\mathbf{i} - 3\mathbf{j} + \mathbf{k}, \text{ then } \hat{\mathbf{u}} &= \frac{1}{|\mathbf{u}|} \mathbf{u} = \frac{1}{\sqrt{2^2 + (-3)^2 + 1^2}} (2\mathbf{i} - 3\mathbf{j} + \mathbf{k}) \\ &= \frac{1}{\sqrt{14}} (2\mathbf{i} - 3\mathbf{j} + \mathbf{k}). \end{aligned}$$

That is, we have a vector that is parallel to \mathbf{u} and of unit length. If we now multiply this unit vector by 10 we will produce a vector parallel to \mathbf{u} but of length 10 units.

$$\text{Required vector is } 10\hat{\mathbf{u}} = \frac{10}{\sqrt{14}} (2\mathbf{i} - 3\mathbf{j} + \mathbf{k}).$$

EXERCISES 26.5

- Find the lengths of these vectors, expressing your answers as surds. It is not necessary to simplify these surds.
 - $\mathbf{i} + 3\mathbf{j}$
 - $5(\mathbf{i} + \mathbf{j})$
 - $5\mathbf{i} - 2\mathbf{j} + \mathbf{k}$
 - $-(2\mathbf{i} + \mathbf{j} + 2\mathbf{k})$
 - $4\mathbf{i} + 6\mathbf{j} - \mathbf{k}$
 - $2\mathbf{i} + 6\mathbf{j} + \mathbf{k}$
 - $\begin{pmatrix} 2 \\ 3 \\ 1 \end{pmatrix}$
 - $\begin{pmatrix} 2 \\ -3 \\ -2 \end{pmatrix}$
- Find unit vectors in the same directions as these vectors:
 - $4\mathbf{i} + 4\mathbf{j}$
 - $4\mathbf{i} + 5\mathbf{j}$
 - $-\mathbf{i} - 2\mathbf{j}$
 - $\mathbf{i} + 6\mathbf{j} - 3\mathbf{k}$
 - $2\mathbf{j} + 4\mathbf{k}$
 - $2\mathbf{i} - 2\mathbf{j} - 3\mathbf{k}$
 - $\begin{pmatrix} 2 \\ 1 \\ 2 \end{pmatrix}$
 - $\begin{pmatrix} -1 \\ 5 \\ 1 \end{pmatrix}$
- A mass sitting on the ground is being pulled by a force of 4 Newtons in a Northerly direction, 3 Newtons in a Westerly direction and 1 Newton upwards.
 - Express the forces acting on the mass in terms of an appropriate vector basis.
 - Find the total magnitude of the force acting on the mass
- Find a vector of length 3 units in the direction of $\mathbf{i} - \mathbf{j} + \mathbf{k}$.
 - Find a vector of length $\sqrt{3}$ units in the direction of $3\mathbf{i} - \mathbf{j} + \sqrt{2}\mathbf{k}$.
- The vectors $\mathbf{a} = 2\mathbf{j} + 4\mathbf{k}$ and $\mathbf{b} = x\mathbf{i} + 3\mathbf{k}$ are of equal length. Find x .
- Find the maximum speed of a particle whose velocity, v m/s, at time t seconds is given by $\mathbf{v} = 2\sin t\mathbf{i} + \cos t\mathbf{j} + 3\mathbf{k}$, $t \geq 0$.

26.6 SCALAR PRODUCT OF 2 VECTORS

26.6.1 DEFINITION OF THE SCALAR PRODUCT

The **scalar product** (or **dot product**) of two vectors is defined by:

$$\mathbf{a} \cdot \mathbf{b} = |\mathbf{a}||\mathbf{b}|\cos\theta$$

where θ is the angle between the two vectors which may be an obtuse angle. The angle must be measured between the directions of the vectors. That is, the angle between the two vectors once they are joined tail to tail.

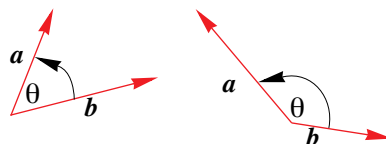

The three quantities on the right hand side of the equation are all scalars and it is important to realise that, when the **scalar** product of two **vectors** is calculated, the result is a **scalar**.

EXAMPLE 26.16

Find the scalar product of the vectors $2\mathbf{i} - 3\mathbf{j} + \mathbf{k}$ and $\mathbf{i} + \mathbf{j} - \mathbf{k}$.

Solution

Let $\mathbf{a} = 2\mathbf{i} - 3\mathbf{j} + \mathbf{k}$ and $\mathbf{b} = \mathbf{i} + \mathbf{j} - \mathbf{k}$, then to determine the scalar product, $\mathbf{a} \cdot \mathbf{b}$, we need to find

1. $|\mathbf{a}|$
2. $|\mathbf{b}|$
3. $\cos\theta$, where θ is the angle between \mathbf{a} and \mathbf{b} .

Finding 1. $|\mathbf{a}| = \sqrt{2^2 + (-3)^2 + 1^2} = \sqrt{14}$.

2. $|\mathbf{b}| = \sqrt{1^2 + 1^2 + (-1)^2} = \sqrt{3}$.

3. $\cos\theta$:

Finding $\cos\theta$ requires a little work. Relative to a common origin O, the points A(2, -3, 1) and B(1, 1, -1) have position vectors \mathbf{a} and \mathbf{b} .

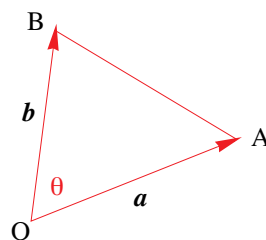

Before making use of the cosine rule we need to determine the length of AB. Using the distance formula between two points in space, we have

$$AB = \sqrt{(1-2)^2 + (1-(-3))^2 + (-1-1)^2} = \sqrt{1+16+4} = \sqrt{21}$$

Cosine rule: $AB^2 = OA^2 + OB^2 - 2 \cdot OA \cdot OB \cdot \cos\theta$

$$(\sqrt{21})^2 = (\sqrt{14})^2 + (\sqrt{3})^2 - 2 \cdot \sqrt{14} \cdot \sqrt{3} \cdot \cos\theta$$

$$21 = 14 + 3 - 2\sqrt{42}\cos\theta$$

$$\therefore \cos\theta = -\frac{2}{\sqrt{42}}$$

Next, from the definition of the scalar product, $\mathbf{a} \cdot \mathbf{b} = |\mathbf{a}||\mathbf{b}|\cos\theta$, we have

$$\mathbf{a} \cdot \mathbf{b} = \sqrt{14} \times \sqrt{3} \times -\frac{2}{\sqrt{42}} = -2$$

The solution to Example 26.16 was rather lengthy, however, we now look at the scalar product from a slightly different viewpoint.

First consider the dot product $\mathbf{i} \cdot \mathbf{i}$: Using the definition, we have that
 $\mathbf{i} \cdot \mathbf{i} = |\mathbf{i}||\mathbf{i}|\cos 0 = 1 \times 1 \times 1 = 1$

[the angle between the vectors \mathbf{i} and \mathbf{i} is 0 and so $\cos\theta = \cos 0 = 1$].

Next consider the product $\mathbf{i} \cdot \mathbf{j}$: Using the definition, we have that
 $\mathbf{i} \cdot \mathbf{j} = |\mathbf{i}||\mathbf{j}|\cos 90 = 1 \times 1 \times 0 = 0$

[the angle between the vectors \mathbf{i} and \mathbf{j} is 90° and so $\cos\theta = \cos 90^\circ = 0$].

Similarly, we end up with the following results for all possible combinations of the \mathbf{i} , \mathbf{j} and \mathbf{k} vectors:

$$\mathbf{i} \cdot \mathbf{i} = \mathbf{j} \cdot \mathbf{j} = \mathbf{k} \cdot \mathbf{k} = 1$$

and

$$\mathbf{i} \cdot \mathbf{j} = \mathbf{i} \cdot \mathbf{k} = \mathbf{j} \cdot \mathbf{k} = \mathbf{j} \cdot \mathbf{i} = \mathbf{k} \cdot \mathbf{i} = \mathbf{k} \cdot \mathbf{j} = 0$$

Armed with these results we can now work out the scalar product of the vectors $\mathbf{a} = x_1\mathbf{i} + y_1\mathbf{j} + z_1\mathbf{k}$ and $\mathbf{b} = x_2\mathbf{i} + y_2\mathbf{j} + z_2\mathbf{k}$ as follows,

$$\begin{aligned} \mathbf{a} \cdot \mathbf{b} &= (x_1\mathbf{i} + y_1\mathbf{j} + z_1\mathbf{k}) \cdot (x_2\mathbf{i} + y_2\mathbf{j} + z_2\mathbf{k}) \\ &= x_1x_2(\mathbf{i} \cdot \mathbf{i}) + x_1y_2(\mathbf{i} \cdot \mathbf{j}) + x_1z_2(\mathbf{i} \cdot \mathbf{k}) \\ &\quad + y_1x_2(\mathbf{j} \cdot \mathbf{i}) + y_1y_2(\mathbf{j} \cdot \mathbf{j}) + y_1z_2(\mathbf{j} \cdot \mathbf{k}) \\ &\quad + z_1x_2(\mathbf{k} \cdot \mathbf{i}) + z_1y_2(\mathbf{k} \cdot \mathbf{j}) + z_1z_2(\mathbf{k} \cdot \mathbf{k}) \\ \therefore \mathbf{a} \cdot \mathbf{b} &= x_1x_2 + y_1y_2 + z_1z_2 \end{aligned}$$

That is, if

$$\mathbf{a} = x_1\mathbf{i} + y_1\mathbf{j} + z_1\mathbf{k} \text{ and } \mathbf{b} = x_2\mathbf{i} + y_2\mathbf{j} + z_2\mathbf{k} \text{ then } \mathbf{a} \cdot \mathbf{b} = x_1x_2 + y_1y_2 + z_1z_2$$

Using this result with the vectors of Example 26.16, $2\mathbf{i} - 3\mathbf{j} + \mathbf{k}$ and $\mathbf{i} + \mathbf{j} - \mathbf{k}$ we have:

$$\begin{aligned} (2\mathbf{i} - 3\mathbf{j} + \mathbf{k}) \cdot (\mathbf{i} + \mathbf{j} - \mathbf{k}) &= 2 \times 1 + (-3) \times 1 + 1 \times (-1) \\ &= 2 - 3 - 1 \\ &= -2 \end{aligned}$$

A much faster process!

However, the most usual use of scalar product is to calculate the angle between vectors using a rearrangement of the definition of scalar product:

$$\cos\theta = \frac{\mathbf{a} \cdot \mathbf{b}}{|\mathbf{a}||\mathbf{b}|}$$

EXAMPLE 26.17

For the following pairs of vectors, find their magnitudes and scalar products. Hence find the angles between the vectors, correct to the nearest degree.

- (a) $-\mathbf{i} + 3\mathbf{j}$ and $-\mathbf{i} + 2\mathbf{j}$ (b) $\begin{pmatrix} 0 \\ -5 \\ 4 \end{pmatrix}$ and $\begin{pmatrix} -5 \\ -1 \\ -3 \end{pmatrix}$

(a) In using the scalar product, it is necessary to calculate the magnitudes of the vectors.

$$|-i + 3j| = \sqrt{(-1)^2 + 3^2} = \sqrt{10} \quad \text{and} \quad |-i + 2j| = \sqrt{(-1)^2 + 2^2} = \sqrt{5}$$

Next, calculate the scalar product: $-i + 3j$ and $-i + 2j$

$$(-i + 3j) \cdot (-i + 2j) = -1 \times -1 + 3 \times 2 = 7$$

Finally, the angle is: $\cos \theta = \frac{\mathbf{a} \cdot \mathbf{b}}{|\mathbf{a}||\mathbf{b}|} = \frac{7}{\sqrt{10} \times \sqrt{5}} \Rightarrow \theta \approx 8^\circ$

(b) $\left| \begin{pmatrix} 0 \\ -5 \\ 4 \end{pmatrix} \right| = \sqrt{0^2 + (-5)^2 + 4^2} = \sqrt{41}$ and $\left| \begin{pmatrix} -5 \\ -1 \\ -3 \end{pmatrix} \right| = \sqrt{(-5)^2 + (-1)^2 + (-3)^2} = \sqrt{35}$

Next, the scalar product:

$$\begin{pmatrix} 0 \\ -5 \\ 4 \end{pmatrix} \cdot \begin{pmatrix} -5 \\ -1 \\ -3 \end{pmatrix} = 0 \times (-5) + (-5) \times (-1) + 4 \times (-3) = -7$$

Finally, the angle can be calculated:

$$\cos \theta = \frac{\mathbf{a} \cdot \mathbf{b}}{|\mathbf{a}||\mathbf{b}|} = \frac{-7}{\sqrt{41} \times \sqrt{35}} \Rightarrow \theta \approx 101^\circ$$

The use of cosine means that obtuse angles between vectors (which occur when the scalar product is negative) are calculated correctly when using the inverse cosine function on a calculator.

26.6.2 PROPERTIES OF THE SCALAR PRODUCT

Closure The scalar product of two vectors is a scalar (i.e., the result is not a vector). The operation is **not closed** and so closure does not apply.

Commutative Now, $\mathbf{a} \cdot \mathbf{b} = |\mathbf{a}||\mathbf{b}| \cos \theta = |\mathbf{b}||\mathbf{a}| \cos \theta = \mathbf{b} \cdot \mathbf{a}$
That is, $\mathbf{a} \cdot \mathbf{b} = \mathbf{b} \cdot \mathbf{a}$.
Therefore the operation of scalar product is commutative

Associative If the associative property were to hold it would take on the form $(\mathbf{a} \cdot \mathbf{b}) \cdot \mathbf{c} = \mathbf{a} \cdot (\mathbf{b} \cdot \mathbf{c})$. However, $\mathbf{a} \cdot \mathbf{b}$ is a real number and therefore the operation $(\mathbf{a} \cdot \mathbf{b}) \cdot \mathbf{c}$ has no meaning [you cannot ‘dot’ a scalar with a vector].

Distributive The **scalar product is distributive** (over addition)
We leave the proof of this result as an exercise.

Identity As the operation of scalar product is not closed, an identity cannot exist.

Inverse As the operation of scalar product is not closed, an inverse cannot exist.

Note that although the scalar product is non-associative, the following ‘associative rule’ holds for the scalar product:

$$\text{If } k \in \mathbb{R}, \text{ then, } \mathbf{a} \cdot (k\mathbf{b}) = k(\mathbf{a} \cdot \mathbf{b})$$

26.6.3 SPECIAL CASES OF THE SCALAR PRODUCT

1. Perpendicular Vectors

If the vectors \mathbf{a} and \mathbf{b} are perpendicular then, $\mathbf{a} \cdot \mathbf{b} = |\mathbf{a}||\mathbf{b}| \cos 90^\circ = 0$.

[Note: We are assuming that \mathbf{a} and \mathbf{b} are non-zero vectors.]

2. Zero vector

For any vector \mathbf{a} , $\mathbf{a} \cdot \mathbf{0} = |\mathbf{a}||\mathbf{0}| \cos \theta = 0$.

3. Parallel vectors

If the vectors \mathbf{a} and \mathbf{b} are parallel then, $\mathbf{a} \cdot \mathbf{b} = |\mathbf{a}||\mathbf{b}| \cos 0 = |\mathbf{a}||\mathbf{b}|$.

If the vectors \mathbf{a} and \mathbf{b} are antiparallel then, $\mathbf{a} \cdot \mathbf{b} = |\mathbf{a}||\mathbf{b}| \cos \pi = -|\mathbf{a}||\mathbf{b}|$.

[Note: We are assuming that \mathbf{a} and \mathbf{b} are non-zero vectors.]

Combining the results of 1., and 2., above, we have the important observation that

If $\mathbf{a} \cdot \mathbf{b} = 0$ then either

1. \mathbf{a} and/or \mathbf{b} are both the zero vector, $\mathbf{0}$.

Or

2. \mathbf{a} and \mathbf{b} are perpendicular with neither \mathbf{a} nor \mathbf{b} being the zero vector.

Notice how this result differs from the standard Null Factor Law when dealing with real numbers, where given $ab = 0$ then a or b or both are zero! That is, the **cancellation property** that holds for real numbers **does not hold for vectors**.

A nice application using the perpendicular property above can be seen in the next example.

EXAMPLE 26.18

Three towns are joined by straight roads. Oakham is the state capital and is considered as the ‘origin’. Axthorp is 3km East and 9km North of Oakham and Bostock is 5km East and 5km South of Axthorp.

Considering \mathbf{i} as a 1km vector pointing East and \mathbf{j} a 1km vector pointing North:

- (a) Find the position vector of Axthorp relative to Oakham.
- (b) Find the position vector of Bostock relative to Oakham.

A bus stop (S) is situated two thirds of the way along the road from Oakham to Axthorp.

- (c) Find the vectors \overrightarrow{OS} and \overrightarrow{BS} .
- (d) Prove that the bus stop is the closest point to Bostock on the Oakham to Axthorp road.

S
o
l
u
t
i
o
n

- (a) Axthorp is 3km East and 9km North of Oakham so $\vec{OA} = 3\mathbf{i} + 9\mathbf{j}$
- (b) $\vec{OB} = \vec{OA} + \vec{AB} = 3\mathbf{i} + 9\mathbf{j} + 5\mathbf{i} - 5\mathbf{j} = 8\mathbf{i} + 4\mathbf{j}$
- (c) $\vec{OS} = \frac{2}{3}(\vec{OA}) = \frac{2}{3}(3\mathbf{i} + 9\mathbf{j}) = 2\mathbf{i} + 6\mathbf{j}$
- $\vec{BS} = \vec{BO} + \vec{OS} = -(8\mathbf{i} + 4\mathbf{j}) + 2\mathbf{i} + 6\mathbf{j} = -6\mathbf{i} + 2\mathbf{j}$
- (d) The next step is to calculate the angle between \vec{OS} and \vec{BS} by calculating the scalar product of the two vectors:
- $\vec{OS} \cdot \vec{BS} = (2\mathbf{i} + 6\mathbf{j}) \cdot (-6\mathbf{i} + 2\mathbf{j}) = 2 \times (-6) + 6 \times 2 = 0$

This means that \vec{OS} and \vec{BS} are at right angles to each other. It follows that the bus stop is the closest point to Bostock on the Oakham to Axthorp road.

EXAMPLE 26.19

Find the value(s) of m for which the vectors $2m\mathbf{i} + m\mathbf{j} + 8\mathbf{k}$ and $\mathbf{i} + 3m\mathbf{j} - \mathbf{k}$ are perpendicular.

S
o
l
u
t
i
o
n

As the two vectors are perpendicular, then

$$\begin{aligned} (2m\mathbf{i} + m\mathbf{j} + 8\mathbf{k}) \cdot (\mathbf{i} + 3m\mathbf{j} - \mathbf{k}) &= 0 \\ \Rightarrow 2m + 3m^2 - 8 &= 0 \\ \Leftrightarrow 3m^2 + 2m - 8 &= 0 \\ \Leftrightarrow (3m - 4)(m + 2) &= 0 \\ \Leftrightarrow m = \frac{4}{3} \text{ or } m = -2 \end{aligned}$$

EXAMPLE 26.20

Find a vector perpendicular to $\mathbf{u} = 4\mathbf{i} - 3\mathbf{j}$.

S
o
l
u
t
i
o
n

Let the vector perpendicular to $\mathbf{u} = 4\mathbf{i} - 3\mathbf{j}$ be $\mathbf{v} = x\mathbf{i} + y\mathbf{j}$.

Then, as $\mathbf{u} \perp \mathbf{v} \Rightarrow \mathbf{u} \cdot \mathbf{v} = 0$ so that $(4\mathbf{i} - 3\mathbf{j}) \cdot (x\mathbf{i} + y\mathbf{j}) = 0$

$$\therefore 4x - 3y = 0 \quad (1)$$

Unfortunately, at this stage we only have one equation for two unknowns! We need to obtain a second equation from somewhere. To do this we recognise the fact that if \mathbf{v} is perpendicular to \mathbf{u} , then so too will the unit vector, $\hat{\mathbf{v}}$, be perpendicular to \mathbf{u} .

Then, as $|\hat{\mathbf{v}}| = 1 \Rightarrow \sqrt{x^2 + y^2} = 1 \therefore x^2 + y^2 = 1 \quad (2)$

From (1) we have that $y = \frac{4}{3}x \quad (3)$

Substituting (3) into (2) we have: $x^2 + \left(\frac{4}{3}x\right)^2 = 1 \Leftrightarrow 25x^2 = 9 \Leftrightarrow x = \pm\frac{3}{5}$

Substituting into (3) we have: $y = \pm \frac{4}{5}$

Therefore, both $v = \frac{3}{5}i + \frac{4}{5}j$ and $v = -(\frac{3}{5}i + \frac{4}{5}j)$ are perpendicular to u .

EXAMPLE 26.21

Use a vector method to derive the cosine rule for the triangle shown.

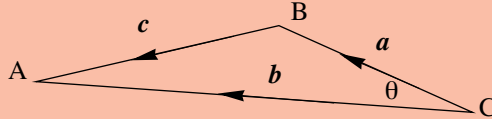
Solution

From the triangle rule for vector addition we have $a + c = b \Leftrightarrow c = b - a$.

Now, using the scalar product we have:

$$\begin{aligned} c \cdot c &= (b - a) \cdot (b - a) \\ &= b \cdot b - b \cdot a - a \cdot b + a \cdot a \\ &= |b|^2 - 2a \cdot b + |a|^2 \\ \therefore |c|^2 &= |b|^2 + |a|^2 - 2|a||b|\cos\theta \end{aligned}$$

EXAMPLE 26.22

Find a vector perpendicular to both $a = 2i + j - k$ and $b = i + 3j + k$.

Solution

Let the vector $c = xi + yj + zk$ be perpendicular to both a and b .

Then, we have that $a \cdot c = 0$ and $b \cdot c = 0$.

From $a \cdot c = 0$ we obtain: $(2i + j - k) \cdot (xi + yj + zk) = 2x + y - z = 0$ – (1)

From $b \cdot c = 0$ we obtain: $(i + 3j + k) \cdot (xi + yj + zk) = x + 3y + z = 0$ – (2)

In order to solve for the three unknowns we need one more equation. We note that if c is perpendicular to a and b then so too will the unit vector, \hat{c} . So, without any loss in generality, we can assume that c is a unit vector. This will provide a third equation.

As we are assuming that c is a unit vector, we have: $|c| = 1 \therefore x^2 + y^2 + z^2 = 1$ – (3)

We can now solve for x , y and z :

$$(1) + (2): \quad 3x + 4y = 0 \text{ – (4)}$$

$$2 \times (1) - (2): \quad 5y + 3z = 0 \text{ – (5)}$$

Substituting (4) and (5) into (3): $\left(-\frac{4}{3}y\right)^2 + y^2 + \left(-\frac{5}{3}y\right)^2 = 1$

$$\Leftrightarrow 16y^2 + 9y^2 + 25y^2 = 9$$

$$\Leftrightarrow 50y^2 = 9$$

$$\Leftrightarrow y = \pm \frac{3}{5\sqrt{2}}$$

$$\therefore y = \pm \frac{3\sqrt{2}}{10}$$

Substituting into (4) and (5) we obtain $x = -\frac{4}{3} \times \pm \frac{3\sqrt{2}}{10} = \mp \frac{2\sqrt{2}}{5}$ and $z = -\frac{5}{3} \times \pm \frac{3\sqrt{2}}{10} = \mp \frac{\sqrt{2}}{2}$.

Therefore, $\mp \frac{2\sqrt{2}}{5} \mathbf{i} \pm \frac{3\sqrt{2}}{10} \mathbf{j} \mp \frac{\sqrt{2}}{2} \mathbf{k}$ or $\mp \left(\frac{2\sqrt{2}}{5} \mathbf{i} - \frac{3\sqrt{2}}{10} \mathbf{j} + \frac{\sqrt{2}}{2} \mathbf{k} \right)$ are two vectors perpendicular to \mathbf{a} and \mathbf{b} . Of course any multiple of this vector will also be perpendicular to \mathbf{a} and \mathbf{b} .

As we have already seen in Example 26.21, the scalar product is a very powerful tool when proving theorems in geometry. We now look at another theorem that is otherwise lengthy to prove by standard means.

EXAMPLE 26.23

Prove that the median to the base of an isosceles triangle is perpendicular to the base.

Solution

Consider the triangle ABC as shown, where M is the mid-point of the base \overline{BC} . Next, let $\mathbf{a} = \overline{AB}$ and $\mathbf{b} = \overline{AC}$. We then wish to show that $\overline{AM} \perp \overline{BC}$ (or $\overline{AM} \cdot \overline{BC} = 0$).

$$\begin{aligned} \text{Now, } \overline{AM} &= \overline{AB} + \overline{BM} = \overline{AB} + \frac{1}{2}\overline{BC} \\ &= \mathbf{a} + \frac{1}{2}(\mathbf{b} - \mathbf{a}) \\ &= \frac{1}{2}(\mathbf{a} + \mathbf{b}) \end{aligned}$$

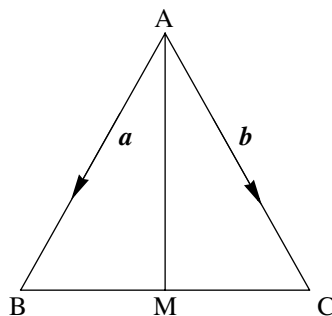

$$\begin{aligned} \text{Therefore, } \overline{AM} \cdot \overline{BC} &= \frac{1}{2}(\mathbf{a} + \mathbf{b}) \cdot (\mathbf{b} - \mathbf{a}) \\ &= \frac{1}{2}(\mathbf{a} \cdot \mathbf{b} - \mathbf{a} \cdot \mathbf{a} + \mathbf{b} \cdot \mathbf{b} - \mathbf{b} \cdot \mathbf{a}) \\ &= \frac{1}{2}(-|\mathbf{a}|^2 + |\mathbf{b}|^2) \quad [\text{because } \mathbf{a} \cdot \mathbf{b} = \mathbf{b} \cdot \mathbf{a}] \\ &= 0 \quad [\text{because } |\mathbf{a}| = |\mathbf{b}|] \end{aligned}$$

Therefore, as $\overline{AM} \neq \mathbf{0}$ and $\overline{BC} \neq \mathbf{0}$, then $\overline{AM} \cdot \overline{BC} = 0 \Rightarrow \overline{AM} \perp \overline{BC}$.
i.e., the median is perpendicular to the base.

26.6.4 DIRECTION COSINES

Let α , β and γ denote the angles that the position vector

$$\overline{OP} = \mathbf{r} = x\mathbf{i} + y\mathbf{j} + z\mathbf{k}$$

makes with the positive directions of the x -, y - and z - axes respectively.

These angles, are known as the direction angles of \mathbf{r} and the cosines of these angles, i.e., $\cos \alpha$, $\cos \beta$ and $\cos \gamma$ are known as the **direction cosines** of \mathbf{r} .

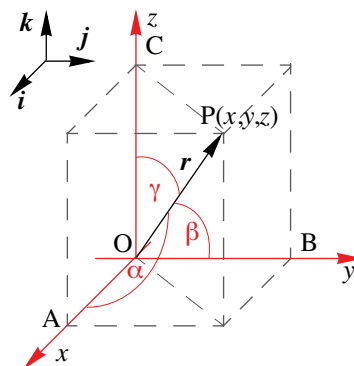

We denote the direction cosines of \mathbf{r} by the letters l, m and n respectively.
So that

$$l = \cos \alpha = \frac{x}{|\mathbf{r}|}, \quad m = \cos \beta = \frac{y}{|\mathbf{r}|}, \quad n = \cos \gamma = \frac{z}{|\mathbf{r}|}$$

Where $\cos \alpha = \frac{x}{|\mathbf{r}|}$ is obtained from $\triangle OAP$

$\cos \beta = \frac{y}{|\mathbf{r}|}$ is obtained from $\triangle OBP$

and $\cos \gamma = \frac{z}{|\mathbf{r}|}$ is obtained from $\triangle OCP$

Also, realise then, that the unit vector, $\hat{\mathbf{r}}$, is such that

$$\hat{\mathbf{r}} = \frac{1}{|\mathbf{r}|}\mathbf{r} = \frac{1}{|\mathbf{r}|}(x\mathbf{i} + y\mathbf{j} + z\mathbf{k}) = \frac{x}{|\mathbf{r}}\mathbf{i} + \frac{y}{|\mathbf{r}}\mathbf{j} + \frac{z}{|\mathbf{r}}\mathbf{k} = \cos \alpha \mathbf{i} + \cos \beta \mathbf{j} + \cos \gamma \mathbf{k}$$

This gives the results $\cos^2 \alpha + \cos^2 \beta + \cos^2 \gamma = 1$ or $l^2 + m^2 + n^2 = 1$.

This means that if θ is the angle between two vectors, $\mathbf{a} = x_1\mathbf{i} + y_1\mathbf{j} + z_1\mathbf{k}$ and $\mathbf{b} = x_2\mathbf{i} + y_2\mathbf{j} + z_2\mathbf{k}$ with direction cosines l_1, m_1, n_1 and l_2, m_2, n_2 respectively, then

$$\cos \theta = l_1 l_2 + m_1 m_2 + n_1 n_2$$

We will come across this result at a later stage, when we look at the angle between two straight lines. At this stage however, you should realise that this result is a simple extension of using the scalar product to find the angle between two vectors. That is, the cosine of the angle between the vectors \mathbf{a} and \mathbf{b} is the same as the cosine of the angle between their unit vectors $\hat{\mathbf{a}}$ and $\hat{\mathbf{b}}$ – which is what we are saying when we use $\cos \theta = l_1 l_2 + m_1 m_2 + n_1 n_2$.

EXAMPLE 26.24

Consider the vectors $\mathbf{a} = 2\mathbf{i} - \sqrt{2}\mathbf{j} + \mathbf{k}$ and $\mathbf{b} = -\mathbf{i} + 2\mathbf{j} - \mathbf{k}$.

- (a) Find the direction cosines of the vector \mathbf{a} .
- (b) Find the direction angles of \mathbf{b} .
- (c) Find the cosine of the angle between \mathbf{a} and \mathbf{b} .

Solution

(a) We first need to find $|\mathbf{a}|$: $|\mathbf{a}| = \sqrt{2^2 + (-\sqrt{2})^2 + 1^2} = \sqrt{7}$.

Then, $\hat{\mathbf{a}} = \frac{1}{|\mathbf{a}|}(2\mathbf{i} - \sqrt{2}\mathbf{j} + \mathbf{k}) = \frac{1}{\sqrt{7}}(2\mathbf{i} - \sqrt{2}\mathbf{j} + \mathbf{k}) = \frac{2}{\sqrt{7}}\mathbf{i} - \frac{\sqrt{2}}{\sqrt{7}}\mathbf{j} + \frac{1}{\sqrt{7}}\mathbf{k}$

So that the direction cosines are $\cos \alpha = \frac{2}{\sqrt{7}}$, $\cos \beta = -\frac{\sqrt{2}}{\sqrt{7}}$ and $\cos \gamma = \frac{1}{\sqrt{7}}$.

(b) As in part (a) we find the unit vector of \mathbf{b} : $|\mathbf{b}| = \sqrt{1 + 4 + 1} = \sqrt{6}$.

$$\therefore \hat{\mathbf{b}} = -\frac{1}{\sqrt{6}}\mathbf{i} + \frac{2}{\sqrt{6}}\mathbf{j} - \frac{1}{\sqrt{6}}\mathbf{k}$$

MATHEMATICS – Higher Level (Core)

To find the directional angles of \mathbf{b} we have,

$$\cos \alpha = -\frac{1}{\sqrt{6}} \text{ so that } \alpha = \arccos\left(-\frac{1}{\sqrt{6}}\right) \approx 114^\circ 6'$$

$$\cos \beta = \frac{2}{\sqrt{6}} \text{ so that } \beta = \arccos\left(\frac{2}{\sqrt{6}}\right) \approx 35^\circ 16'$$

and
$$\cos \gamma = -\frac{1}{\sqrt{6}} \text{ so that } \gamma = \arccos\left(-\frac{1}{\sqrt{6}}\right) \approx 114^\circ 6'$$

(c) If θ is the angle between \mathbf{a} and \mathbf{b} then using the direction cosines of \mathbf{a} and \mathbf{b} we have

$$\begin{aligned} \cos \theta &= l_1 l_2 + m_1 m_2 + n_1 n_2 = \frac{2}{\sqrt{7}} \times -\frac{1}{\sqrt{6}} + \left(-\frac{\sqrt{2}}{\sqrt{7}}\right) \times \frac{2}{\sqrt{6}} + \frac{1}{\sqrt{7}} \times \left(-\frac{1}{\sqrt{6}}\right) \\ &= \frac{-2 - 2\sqrt{2} - 1}{\sqrt{42}} \\ &= -\frac{3 + 2\sqrt{2}}{\sqrt{42}} \end{aligned}$$

EXERCISES 26.6

1. Find the scalar product, $\mathbf{a} \cdot \mathbf{b}$, for each of the following

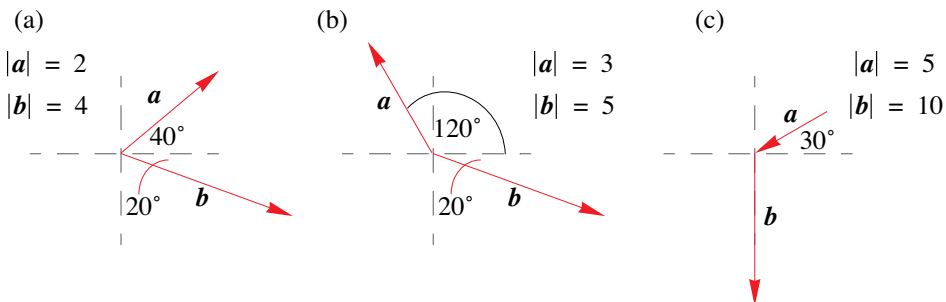

2. Find the scalar products of these pairs of vectors.

- | | |
|--|--|
| (i) $3\mathbf{i} + 2\mathbf{j}$ and $2\mathbf{i} + 3\mathbf{j}$ | (ii) $3\mathbf{i} + 7\mathbf{j}$ and $2\mathbf{i} + 3\mathbf{j}$ |
| (iii) $3\mathbf{i} - \mathbf{j}$ and $-2\mathbf{i} + 2\mathbf{j}$ | (iv) $6\mathbf{i} + \mathbf{j} - \mathbf{k}$ and $-7\mathbf{i} - 4\mathbf{j} + 3\mathbf{k}$ |
| (v) $-\mathbf{j} + 5\mathbf{k}$ and $-4\mathbf{i} + \mathbf{j} + \mathbf{k}$ | (vi) $-\mathbf{i} + 5\mathbf{j} + 4\mathbf{k}$ and $5\mathbf{i} - 4\mathbf{k}$ |
| (vii) $\begin{pmatrix} 0 \\ 6 \\ 1 \end{pmatrix}$ and $\begin{pmatrix} 7 \\ 2 \\ -6 \end{pmatrix}$ | (viii) $\begin{pmatrix} -3 \\ -1 \\ 7 \end{pmatrix}$ and $\begin{pmatrix} 3 \\ 2 \\ 1 \end{pmatrix}$ |
| (ix) $\begin{pmatrix} -6 \\ -1 \\ 7 \end{pmatrix}$ and $\begin{pmatrix} 7 \\ 3 \\ 5 \end{pmatrix}$ | |

3. Find the angles between these pairs of vectors, giving the answers in degrees, correct to the nearest degree.

- | | |
|--|---|
| (i) $-4\mathbf{i} - 4\mathbf{j}$ and $-3\mathbf{i} + 2\mathbf{j}$ | (ii) $\mathbf{i} - \mathbf{j}$ and $3\mathbf{i} + 6\mathbf{j}$ |
| (iii) $-4\mathbf{i} - 2\mathbf{j}$ and $-\mathbf{i} - 7\mathbf{j}$ | (iv) $-7\mathbf{i} + 3\mathbf{j}$ and $-2\mathbf{i} - \mathbf{j}$ |

(v) $\mathbf{i} + 3\mathbf{j} + 7\mathbf{k}$ and $6\mathbf{i} + 7\mathbf{j} - \mathbf{k}$ (vi) $\mathbf{j} + 3\mathbf{k}$ and $-\mathbf{j} - 2\mathbf{k}$

(vii) $\begin{pmatrix} -3 \\ -1 \\ -5 \end{pmatrix}$ and $\begin{pmatrix} 4 \\ 5 \\ -5 \end{pmatrix}$ (viii) $\begin{pmatrix} -2 \\ 7 \\ -7 \end{pmatrix}$ and $\begin{pmatrix} 5 \\ 2 \\ -5 \end{pmatrix}$

4. Two vectors are defined as $\mathbf{a} = 2\mathbf{i} + x\mathbf{j}$ and $\mathbf{b} = \mathbf{i} - 4\mathbf{j}$. Find the value of x if:

- (i) the vectors are parallel.
 (ii) the vectors are perpendicular.

5. If $\mathbf{a} = 2\mathbf{i} - 3\mathbf{j} + \mathbf{k}$, $\mathbf{b} = -\mathbf{i} + 2\mathbf{j} + 2\mathbf{k}$ and $\mathbf{c} = \mathbf{i} + \mathbf{k}$, find, where possible,

- (a) $\mathbf{a} \cdot \mathbf{b}$ (b) $(\mathbf{a} - \mathbf{b}) \cdot \mathbf{c}$ (c) $\mathbf{a} \cdot \mathbf{b} \cdot \mathbf{c}$
 (d) $(\mathbf{a} - \mathbf{b}) \cdot (\mathbf{a} + \mathbf{b})$ (e) $\frac{\mathbf{a}}{\mathbf{c}}$ (f) $\mathbf{b} \cdot \mathbf{0}$

6. If $\mathbf{a} = 2\mathbf{i} - \sqrt{3}\mathbf{j}$, $\mathbf{b} = \sqrt{3}\mathbf{i} - \mathbf{j}$ and $\mathbf{c} = \mathbf{i} + \mathbf{j}$ find, where possible,

- (a) $\mathbf{a} \cdot (\mathbf{b} + \mathbf{c}) + \mathbf{b} \cdot (\mathbf{c} - \mathbf{a}) + \mathbf{c} \cdot (\mathbf{a} - \mathbf{b})$ (b) $(\mathbf{b} - \mathbf{c}) \cdot (\mathbf{c} - \mathbf{b}) + |\mathbf{b}|^2$
 (c) $2|\mathbf{a}|^2 - \sqrt{3}\mathbf{c} \cdot \mathbf{c}$ (d) $\sqrt{\frac{\mathbf{a}}{|\mathbf{a}|} + \frac{\mathbf{b}}{|\mathbf{b}|} + \frac{\mathbf{c}}{|\mathbf{c}|}}$

7. Find the value(s) of x for which the vectors $x\mathbf{i} + \mathbf{j} - \mathbf{k}$ and $x\mathbf{i} - 2x\mathbf{j} - \mathbf{k}$ are perpendicular.

8. P, Q and R are three points in space with coordinates (2, -1, 4), (3, 1, 2) and (-1, 2, 5) respectively. Find angle Q in the triangle PQR.

9. Find the values of x and y if $\mathbf{u} = x\mathbf{i} + 2y\mathbf{j} - 8\mathbf{k}$ is perpendicular to both $\mathbf{v} = 2\mathbf{i} - \mathbf{j} + \mathbf{k}$ and $\mathbf{w} = 3\mathbf{i} + 2\mathbf{j} - 4\mathbf{k}$.

10. Find the unit vector that is perpendicular to both $\mathbf{a} = 3\mathbf{i} + 6\mathbf{j} - \mathbf{k}$ and $\mathbf{b} = 4\mathbf{i} + \mathbf{j} + \mathbf{k}$.

11. Show that if \mathbf{u} is a vector in three dimensions, then $\mathbf{u} = (\mathbf{u} \cdot \mathbf{i})\mathbf{i} + (\mathbf{u} \cdot \mathbf{j})\mathbf{j} + (\mathbf{u} \cdot \mathbf{k})\mathbf{k}$.

12. (a) Find a vector perpendicular to both $\mathbf{a} = -\mathbf{i} + 2\mathbf{j} + 4\mathbf{k}$ and $\mathbf{b} = 2\mathbf{i} - 3\mathbf{j} + 2\mathbf{k}$.

(b) Find a vector perpendicular to $2\mathbf{i} + \mathbf{j} - 7\mathbf{k}$.

13. Show that if $|\mathbf{a} - \mathbf{b}| = |\mathbf{a} + \mathbf{b}|$, where $\mathbf{a} \neq \mathbf{0}$ and $\mathbf{b} \neq \mathbf{0}$, then \mathbf{a} and \mathbf{b} are perpendicular.

14. If $\mathbf{a} \cdot \mathbf{b} = \mathbf{a} \cdot \mathbf{c}$ where $\mathbf{a} \neq \mathbf{0} \neq \mathbf{b}$, what conclusion(s) can be made?

15. Find the direction cosine of the following vectors

- (a) $3\mathbf{i} + 4\mathbf{j}$ (b) $\sqrt{2}\mathbf{i} + \mathbf{j} - \mathbf{k}$

16. (a) Find the direction cosines of the vector $\mathbf{r} = -2\mathbf{i} + 2\mathbf{j} + \mathbf{k}$.

(b) Hence, find the angles, α , β and γ that \mathbf{r} makes with the positive x -, y - and z - axes respectively.

MATHEMATICS – Higher Level (Core)

- 17.** Using the scalar product for vectors prove that the cosine of the angle between two lines with direction cosines l_1, m_1, n_1 and l_2, m_2, n_2 is given by $\cos \theta = l_1 l_2 + m_1 m_2 + n_1 n_2$.
- 18.** Find the cosine of the acute angle between
- two diagonals of a cube
 - the diagonal of a cube and one of its edges.
- 19.** (a) On the same set of axes sketch the graphs of $x + 3y - 6 = 0$ and $2x - y + 6 = 0$, clearly labelling all intercepts with the axes.
 (b) Find a unit vector along the line
 i. $x + 3y - 6 = 0$.
 ii. $2x - y + 6 = 0$.
 (c) Hence find the acute angle between the two lines $x + 3y - 6 = 0$ and $2x - y + 6 = 0$
- 20.** Find a unit vector \mathbf{a} such that \mathbf{a} makes an angle of 45° with the z -axis and is such that the vector $\mathbf{i} - \mathbf{j} + \mathbf{a}$ is a unit vector.

- 21.** Using the scalar product for vectors prove Pythagoras's Theorem for the triangle ABC shown.

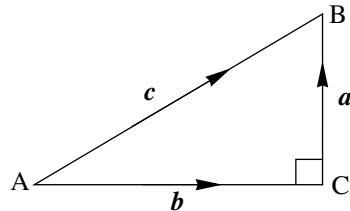

- 22.** Prove that an angle inscribed in a semicircle is a right angle.

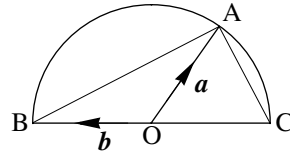

- 23.** In the trapezium shown, $BE:BC = 1:3$.
 Show that $3\mathbf{AC} \cdot \mathbf{DE} = 2(4m^2 - n^2)$
 where $|\mathbf{AB}| = m$, $|\mathbf{DC}| = 2|\mathbf{AB}|$ and $|\mathbf{DA}| = n$

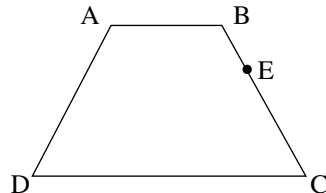

- 24.** Prove that the altitudes of any triangle are concurrent.
- 25.** An oil pipeline runs from a well (W) to a distribution point (D) which is 4km East and 8km North of the well. A second well (S) is drilled at a point 9km East and 7km South of the distribution point. It is desired to lay a new pipeline from the second well to a point (X) on the original pipeline where the two pipes will be joined. This new pipeline must be as short as possible.
- Set up a suitable vector basis using the first well as the origin.
 - Express \overrightarrow{WD} , \overrightarrow{WS} , \overrightarrow{DS} in terms of your basis.
 - Write a unit vector in the direction of \overrightarrow{WD} .
 - If the point X is d km along the pipeline from the first well, write a vector equal to \overrightarrow{WX} .
 - Hence find the vector \overrightarrow{WX} such that the new pipeline is as short as possible.

26.6.5 USING A GRAPHICS CALCULATOR

Many models of graphics calculator allow entry of vectors and limited calculations with them. The TI 82/3 models use the matrix menu system. After entering the vectors as column matrices, simple arithmetic calculations can be performed. The matrix menu structure will be considered in more detail later in this chapter. More advanced models such as the TI-85 can calculate absolute values and scalar products. These are under the **VECTOR**, **MATH** menus.

We consider two examples.

Example 1 (Addition/subtraction):

To enter and calculate a vector sum such as $3 \times \begin{pmatrix} 2 \\ -3 \\ 1 \end{pmatrix} - 4 \begin{pmatrix} -5 \\ 2 \\ -4 \end{pmatrix}$ the steps are:

Step 1: Enter the two matrices using the **MATRIX** menu, **EDIT** option.

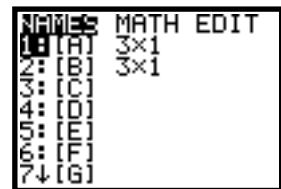

Step 2: Choose matrix A and define the correct dimensions for the vectors, i.e., 3×1 and enter the correct components. Remember to use the ‘negative key’ (–) rather than the subtraction key when entering the negative number. Repeat for matrix B.

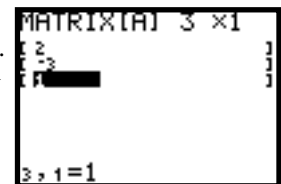

Step 3: The calculation is now completed by keying it as if it were a normal numerical calculation using the memories of the calculator.

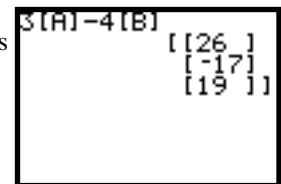

In this case the names of the two vectors are accessed using the **MATRIX NAMES** menu and highlighting the name required at each stage of the calculation.

Example 2 (Scalar product):

To find the scalar product, $\begin{pmatrix} 2 \\ -3 \\ 1 \end{pmatrix} \cdot \begin{pmatrix} -5 \\ 2 \\ -4 \end{pmatrix}$ choose the Matrix A as having dimensions 1×3 and

Matrix B as having dimension 3×1 . Then multiply the matrices:

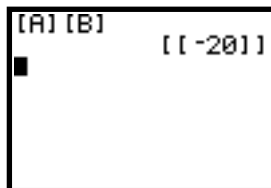
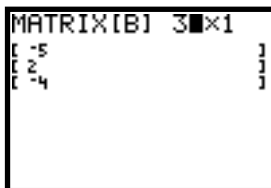

So that in this case, the dot product, is -20 .

26.7 VECTOR EQUATION OF A LINE

26.7.1 VECTOR EQUATION OF A LINE IN 2-D

We start this section by considering the following problem:

Relative to an origin O , a house, situated 8 km North of O , stands next to a straight road. The road runs past a second house, located 4 km East of O . If a person is walking along the road from the house North of O to the house East of O , determine the position of the person while on the road relative to O .

We start by drawing a diagram and place the person along the road at some point P .

We need to determine the position vector of point P .

We have $r = \mathbf{OP} = \mathbf{OA} + \mathbf{AP}$

Now, as P lies somewhere along \overline{AB} , we can write $\mathbf{AP} = \lambda \mathbf{AB}$, where $0 \leq \lambda \leq 1$, so that when $\lambda = 0$ the person is at A and when $\lambda = 1$ the person is at B .

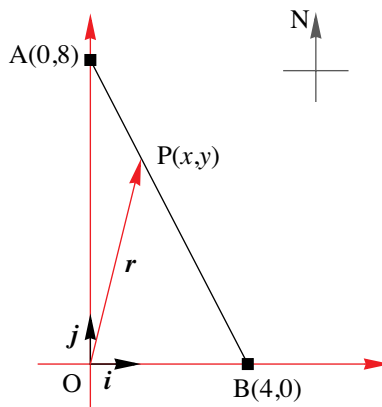

Next, $\mathbf{AB} = \mathbf{AO} + \mathbf{OB} = -8\mathbf{j} + 4\mathbf{i}$, and so we have that

$$r = 8\mathbf{j} + \lambda(-8\mathbf{j} + 4\mathbf{i}).$$

This provides us with the position vector of the person while walking on the road.

We take this equation a little further. The position vector of P can be written as $r = xi + yj$ and so we have that

$$xi + yj = 8\mathbf{j} + \lambda(-8\mathbf{j} + 4\mathbf{i})$$

That is, we have $xi + yj = 4\lambda i + (8 - 8\lambda)j$ meaning that

$$x = 4\lambda \text{ and } y = 8 - 8\lambda$$

The equations $x = 4\lambda$ – (1) and $y = 8 - 8\lambda$ – (2) are known as the **parametric form** of the equations of a straight line

Next, from these parametric equations we have $\lambda = \frac{x}{4}$ – (3) and $\lambda = \frac{y-8}{-8}$ – (4)

Then, equating (3) and (4) we have $\frac{x}{4} = \frac{y-8}{-8}$. This equation is known as the **Cartesian form** of the equation of a straight line. We can go one step further and simplify this last equation.

$$\frac{x}{4} = \frac{y-8}{-8} \Leftrightarrow -2x = y - 8 \Leftrightarrow y = -2x + 8$$

which corresponds to the straight line passing through A and B .

This approach to describe the position of an object (or person) is of great use when dealing with

objects travelling in a straight line. When planes are coming in for landing, it is crucial that their positions along their flight paths are known, otherwise one plane could be heading for a collision with another plane in the air.

We now formalise the definition of the vector equation of a line in a plane:

The vector equation of a line L in the direction of the vector \mathbf{b} , passing through the point A with position vector \mathbf{a} is given by

$$\mathbf{r} = \mathbf{a} + \lambda \mathbf{b}$$

where λ is a scalar parameter.

PROOF:

Let the point $P(x, y)$ be any point on the line L , then the vector \mathbf{AP} is parallel to the vector \mathbf{b} .

$$\begin{aligned} \mathbf{r} &= \mathbf{OP} \\ &= \mathbf{OA} + \mathbf{AP} \\ \therefore \mathbf{r} &= \mathbf{a} + \lambda \mathbf{b} \end{aligned}$$

So the equation of L is given by $\mathbf{r} = \mathbf{a} + \lambda \mathbf{b}$ as required.

We can now derive two other forms for equations of a line. We start by letting the coordinates of A be (a_1, a_2) , the coordinates of P be (x, y) and the vector $\mathbf{b} = \begin{pmatrix} b_1 \\ b_2 \end{pmatrix}$.

From $\mathbf{r} = \mathbf{a} + \lambda \mathbf{b}$ we have, $\begin{pmatrix} x \\ y \end{pmatrix} = \begin{pmatrix} a_1 \\ a_2 \end{pmatrix} + \lambda \begin{pmatrix} b_1 \\ b_2 \end{pmatrix} \Leftrightarrow \begin{pmatrix} x \\ y \end{pmatrix} = \begin{pmatrix} a_1 + \lambda b_1 \\ a_2 + \lambda b_2 \end{pmatrix}$

This provides us with the

Parametric form for the equation of a straight line:

$$\begin{aligned} x &= a_1 + \lambda b_1 \\ y &= a_2 + \lambda b_2 \end{aligned}$$

Next, from the parametric form we have $x = a_1 + \lambda b_1 \Leftrightarrow x - a_1 = \lambda b_1 \Leftrightarrow \lambda = \frac{x - a_1}{b_1}$ – (1)

and $y = a_2 + \lambda b_2 \Leftrightarrow y - a_2 = \lambda b_2 \Leftrightarrow \lambda = \frac{y - a_2}{b_2}$ – (2)

Equating (1) and (2) provides us with the

Cartesian form for the equation of a straight line:

$$\frac{x - a_1}{b_1} = \frac{y - a_2}{b_2}$$

EXAMPLE 26.25

Find the vector equation of the line L, as shown in the diagram.

Comment on the uniqueness of this equation.

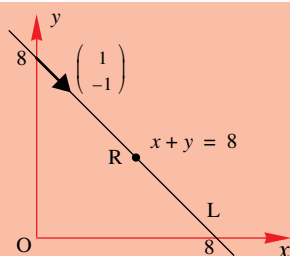

S
o
l
u
t
i
o
n

The vector equation of the line L is based on finding (or using) *any* point on the line, such as $\begin{pmatrix} 0 \\ 8 \end{pmatrix}$, and *any* vector in the direction of the line L, such as $\begin{pmatrix} 1 \\ -1 \end{pmatrix}$.

The position vector of any point R on the line can then be written as $\mathbf{r} = \begin{pmatrix} 0 \\ 8 \end{pmatrix} + \lambda \begin{pmatrix} 1 \\ -1 \end{pmatrix}$.

As λ varies, different points on the line are generated, and conversely any point on the line has a corresponding value of λ . For example, substituting $\lambda = 3$ gives the point $\begin{pmatrix} 3 \\ 5 \end{pmatrix}$ and the point $\begin{pmatrix} 8 \\ 0 \end{pmatrix}$ corresponds to $\lambda = 8$.

NB: the vector equation (in parametric form) is **not unique**. The equation $\mathbf{r} = \begin{pmatrix} 4 \\ 4 \end{pmatrix} + \lambda \begin{pmatrix} -2 \\ 2 \end{pmatrix}$ is an equally valid description of the line, and in this case substituting $\lambda = 0.5$ generates the point $\begin{pmatrix} 3 \\ 5 \end{pmatrix}$.

EXAMPLE 26.26

Find the vector equation of the line L, passing through the point A(2, 5) and parallel to the vector $3\mathbf{i} - 4\mathbf{j}$.

S
o
l
u
t
i
o
n

Rather than depend on a standard formula, it is always helpful to visualise problems such as these, in particular, when we move onto straight lines in space. We draw a general representation of this situation and work from there.

Let the point P be any point on the line L with position vector \mathbf{r} , then $\mathbf{OP} = \mathbf{OA} + \mathbf{AP}$

However, as A and P lie on the line L, then $\mathbf{AP} = \lambda(3\mathbf{i} - 4\mathbf{j})$.

Therefore, $\mathbf{r} = (2\mathbf{i} + 5\mathbf{j}) + \lambda(3\mathbf{i} - 4\mathbf{j})$

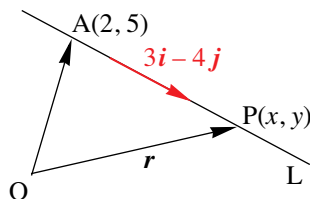

This represents the vector equation of the line L in terms of the parameter λ , where $\lambda \in \mathbb{R}$.

The equation could also be written as, $\mathbf{r} = (2 + 3\lambda)\mathbf{i} + (5 - 4\lambda)\mathbf{j}$.

EXAMPLE 26.27

Find the vector equation of the line L, passing through the points A(1, 4) and B(5, 8). Give both the parametric form and Cartesian form of L.

S
o
l
u
t
i
o
n

We start with a sketch of the situation described:

Let the point P be any point on the line L with position vector \mathbf{r} , then $\mathbf{OP} = \mathbf{OA} + \mathbf{AP}$.
Then, as $\mathbf{AP} \parallel \mathbf{AB} \Rightarrow \mathbf{AP} = \lambda \mathbf{AB}$, where $\lambda \in \mathbb{R}$.

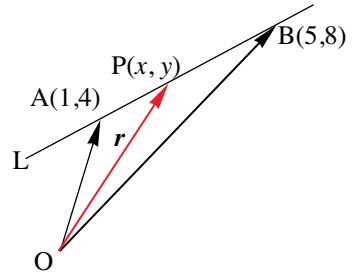

This means that we need to find the vector \mathbf{AB} which will be the vector parallel to the line L. So, we have

$$\mathbf{AB} = \mathbf{AO} + \mathbf{OB} = -\begin{pmatrix} 1 \\ 4 \end{pmatrix} + \begin{pmatrix} 5 \\ 8 \end{pmatrix} = \begin{pmatrix} 4 \\ 4 \end{pmatrix} = 4\begin{pmatrix} 1 \\ 1 \end{pmatrix}$$

Therefore, from $\mathbf{OP} = \mathbf{OA} + \mathbf{AP}$ we have

$$\mathbf{OP} = \begin{pmatrix} 1 \\ 4 \end{pmatrix} + \lambda \times 4\begin{pmatrix} 1 \\ 1 \end{pmatrix}$$

That is, $\mathbf{r} = \begin{pmatrix} 1 \\ 4 \end{pmatrix} + t\begin{pmatrix} 1 \\ 1 \end{pmatrix}$ where $t = 4\lambda$.

This represents the vector equation of the straight line L.

To find the **parametric form** of L we make use of the equation $\mathbf{r} = \begin{pmatrix} 1 \\ 4 \end{pmatrix} + t\begin{pmatrix} 1 \\ 1 \end{pmatrix}$.

As P(x, y) is any point on the line L, we write the vector equation as $\begin{pmatrix} x \\ y \end{pmatrix} = \begin{pmatrix} 1 \\ 4 \end{pmatrix} + t\begin{pmatrix} 1 \\ 1 \end{pmatrix}$.

From where we obtain the parametric equations, $x = 1 + t$ and $y = 4 + t$.

To find the **Cartesian form** of L we now make use of the parametric equations.

From $x = 1 + t$ we have $t = x - 1$ — (1) and from $y = 4 + t$ we have $t = y - 4$ — (2)

Then, equating (1) and (2) we have $x - 1 = y - 4$ (or $y = x + 3$).

EXAMPLE 26.28

The vector equation of the line L, is given by $\mathbf{r} = \begin{pmatrix} 3 + 2\lambda \\ 5 - 5\lambda \end{pmatrix}$.

- (a) Express the vector equation in the standard form $\mathbf{r} = \mathbf{a} + \lambda \mathbf{b}$.
- (b) Find a unit vector in the direction of L.
- (c) Find the Cartesian form of the line L.

S
o
l
u
t
i
o
n

(a) $\mathbf{r} = \begin{pmatrix} 3 + 2\lambda \\ 5 - 5\lambda \end{pmatrix} = \begin{pmatrix} 3 \\ 5 \end{pmatrix} + \begin{pmatrix} 2\lambda \\ -5\lambda \end{pmatrix} = \begin{pmatrix} 3 \\ 5 \end{pmatrix} + \lambda \begin{pmatrix} 2 \\ -5 \end{pmatrix}$ [which is in the form $\mathbf{r} = \mathbf{a} + \lambda \mathbf{b}$]

(b) The direction of the line L is provided by the vector \mathbf{b} , i.e., $\begin{pmatrix} 2 \\ -5 \end{pmatrix}$.

To find the unit vector we need $\left| \begin{pmatrix} 2 \\ -5 \end{pmatrix} \right| = \sqrt{4 + 25} = \sqrt{29}$. $\therefore \hat{\mathbf{b}} = \frac{1}{\sqrt{29}} \begin{pmatrix} 2 \\ -5 \end{pmatrix}$.

(c) Using the point $P(x, y)$ as representing any point on the line L , we have that $\mathbf{r} = \begin{pmatrix} x \\ y \end{pmatrix}$.

Therefore, we can write the vector equation as $\begin{pmatrix} x \\ y \end{pmatrix} = \begin{pmatrix} 3 + 2\lambda \\ 5 - 5\lambda \end{pmatrix}$.

From this equation we then have that $x = 3 + 2\lambda$ – (1)

and $y = 5 - 5\lambda$ – (2)

We can now find the Cartesian equation by eliminating the parameter λ using (1) and (2).

From (1): $\lambda = \frac{x-3}{2}$. From (2): $\lambda = \frac{y-5}{-5}$

Therefore, $\frac{x-3}{2} = \frac{y-5}{-5}$.

EXAMPLE 26.29

Find the angle between the lines $\frac{x-2}{4} = \frac{y+1}{3}$ and $\frac{x+2}{-1} = \frac{y-4}{2}$.

S
O
L
V
E
D

We must first express the lines in their vector form. To do this we need to introduce a parameter for each line.

Let $\frac{x-2}{4} = \frac{y+1}{3} = \lambda$ giving the parametric equations $x = 2 + 4\lambda$ and $y = -1 + 3\lambda$.

We can now express these two parametric equations in the vector form:

$$\begin{pmatrix} x \\ y \end{pmatrix} = \begin{pmatrix} 2 + 4\lambda \\ -1 + 3\lambda \end{pmatrix} = \begin{pmatrix} 2 \\ -1 \end{pmatrix} + \lambda \begin{pmatrix} 4 \\ 3 \end{pmatrix}$$

This vector equation informs us that the line $\frac{x-2}{4} = \frac{y+1}{3}$ is parallel to the vector $\begin{pmatrix} 4 \\ 3 \end{pmatrix}$.

In the same way we can obtain the vector equation of the line $\frac{x+2}{-1} = \frac{y-4}{2}$.

Let $\frac{x+2}{-1} = \frac{y-4}{2} = t$ giving the parametric equations $x = -2 - t$ and $y = 4 + 2t$.

From where we obtain the vector equation $\begin{pmatrix} x \\ y \end{pmatrix} = \begin{pmatrix} -2 - t \\ 4 + 2t \end{pmatrix} = \begin{pmatrix} -2 \\ 4 \end{pmatrix} + t \begin{pmatrix} -1 \\ 2 \end{pmatrix}$.

This vector equation informs us that the line $\frac{x+2}{-1} = \frac{y-4}{2}$ is parallel to the vector $\begin{pmatrix} -1 \\ 2 \end{pmatrix}$.

To find the angle between the two lines we use their direction vectors, $\begin{pmatrix} 4 \\ 3 \end{pmatrix}$ and $\begin{pmatrix} -1 \\ 2 \end{pmatrix}$ along

with the scalar product: $\begin{pmatrix} 4 \\ 3 \end{pmatrix} \cdot \begin{pmatrix} -1 \\ 2 \end{pmatrix} = \left| \begin{pmatrix} 4 \\ 3 \end{pmatrix} \right| \times \left| \begin{pmatrix} -1 \\ 2 \end{pmatrix} \right| \cos \theta \Rightarrow -4 + 6 = \sqrt{16+9} \times \sqrt{1+4} \cos \theta$

$$\Leftrightarrow \cos \theta = \frac{2}{5\sqrt{5}}$$

$$\therefore \theta \approx 79^\circ 42'$$

Notice that when discussing the relationship between two straight lines in a plane there are a number of possible outcomes:

1. The lines are parallel and never meet

In this situation, the lines have the same direction vectors and no common points.

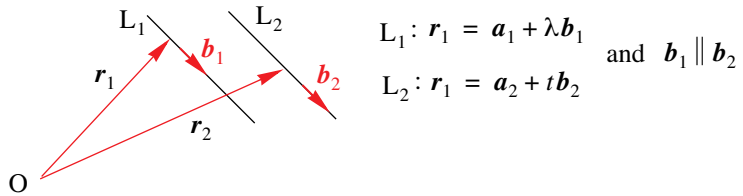

2. The lines are not parallel and therefore intersect at some point.

In this situation, the lines have non-parallel direction vectors and a common point.

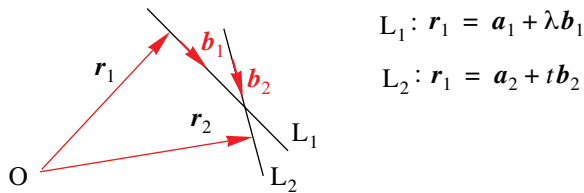

3. The lines are parallel and have a common point, meaning that they are **coincident**.

In this situation, the lines have the same direction vectors and all their points are common.

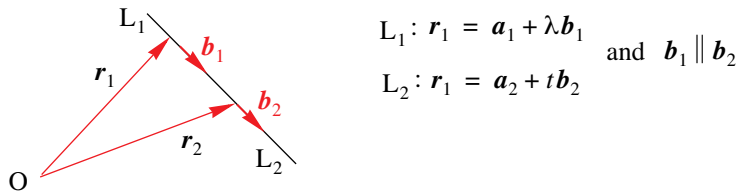

EXAMPLE 26.30

Find the point of intersection of the lines L_1 and L_2 whose vector equations are $\mathbf{r}_1 = 2\mathbf{i} + 3\mathbf{j} + \lambda(2\mathbf{i} + \mathbf{j})$ and $\mathbf{r}_2 = 5\mathbf{i} - 2\mathbf{j} + \mu(\mathbf{i} - 2\mathbf{j})$ respectively.

Solution

If the two lines intersect then there exists a point on L_1 and L_2 such that $\mathbf{r}_1 = \mathbf{r}_2$.

That is,

$$2\mathbf{i} + 3\mathbf{j} + \lambda(2\mathbf{i} + \mathbf{j}) = 5\mathbf{i} - 2\mathbf{j} + \mu(\mathbf{i} - 2\mathbf{j})$$

$$\therefore (2 + 2\lambda)\mathbf{i} + (3 + \lambda)\mathbf{j} = (5 + \mu)\mathbf{i} + (-2 - 2\mu)\mathbf{j}$$

Giving the system of equations $2 + 2\lambda = 5 + \mu$ – (1)

and $3 + \lambda = -2 - 2\mu$ – (2)

Solving for λ : $2 \times (1) + (2)$: $7 + 5\lambda = 8 \Leftrightarrow \lambda = \frac{1}{5}$

Hence, using the vector equation \mathbf{r}_1 , the point of intersection has the position vector

$$\mathbf{r} = 2\mathbf{i} + 3\mathbf{j} + \frac{1}{5}(2\mathbf{i} + \mathbf{j}) = \frac{12}{5}\mathbf{i} + \frac{16}{5}\mathbf{j}. \text{ That is, the lines intersect at the point } \left(\frac{12}{5}, \frac{16}{5}\right).$$

EXERCISES 26.7.1

1. For the straight line with equation $\mathbf{r} = \mathbf{a} + \lambda\mathbf{b}$ where $\mathbf{a} = i + 2j$ and $\mathbf{b} = -2i + 3j$ find the coordinates of the points on the line for which
 - (a) i. $\lambda = 0$ ii. $\lambda = 3$ iii. $\lambda = -2$
 - (b) Use part (a) to sketch the graph of $\mathbf{r} = i + 2j + \lambda(-2i + 3j)$.

2. Find the vector equation of the line passing through the point A and parallel to the vector \mathbf{b} , where
 - (a) $\mathbf{A} \equiv (2, 5)$, $\mathbf{b} = 3i - 4j$
 - (b) $\mathbf{A} \equiv (-3, 4)$, $\mathbf{b} = -i + 5j$
 - (c) $\mathbf{A} \equiv (0, 1)$, $\mathbf{b} = 7i + 8j$
 - (d) $\mathbf{A} \equiv (1, -6)$, $\mathbf{b} = 2i + 3j$
 - (e) $\mathbf{A} \equiv (-1, -1)$, $\mathbf{b} = \begin{pmatrix} -2 \\ 10 \end{pmatrix}$
 - (f) $\mathbf{A} \equiv (1, 2)$, $\mathbf{b} = \begin{pmatrix} 5 \\ 1 \end{pmatrix}$

3. Find a vector equation of the line passing through the points A and B where
 - (a) $\mathbf{A}(2, 3)$, $\mathbf{B}(4, 8)$
 - (b) $\mathbf{A}(1, 5)$, $\mathbf{B}(-2, 1)$
 - (c) $\mathbf{A}(4, -3)$, $\mathbf{B}(-1, -2)$

4. Find the vector equation of the straight line defined by the parametric equations
 - (a) $x = 9 + \lambda$, $y = 5 - 3\lambda$
 - (b) $x = 6 - 4t$, $y = -6 - 2t$
 - (c) $x = -1 - 4\lambda$, $y = 3 + 8\lambda$
 - (d) $x = 1 + \frac{1}{2}\mu$, $y = 2 - \frac{1}{3}\mu$

5. Find the parametric form of the straight line having the vector equation
 - (a) $\mathbf{r} = \begin{pmatrix} -8 \\ 10 \end{pmatrix} + \mu \begin{pmatrix} 2 \\ 1 \end{pmatrix}$
 - (b) $\mathbf{r} = \begin{pmatrix} 7 \\ 4 \end{pmatrix} + \mu \begin{pmatrix} -3 \\ -2 \end{pmatrix}$
 - (c) $\mathbf{r} = \begin{pmatrix} 5 \\ 3 \end{pmatrix} + \frac{\mu}{2} \begin{pmatrix} 5 \\ 1 \end{pmatrix}$
 - (d) $\mathbf{r} = \begin{pmatrix} 0.5 - 0.1t \\ 0.4 + 0.2t \end{pmatrix}$

6. Find the Cartesian form of the straight line having the vector equation
 - (a) $\mathbf{r} = \begin{pmatrix} 1 \\ 3 \end{pmatrix} + \mu \begin{pmatrix} 3 \\ 1 \end{pmatrix}$
 - (b) $\mathbf{r} = \begin{pmatrix} 2 \\ 4 \end{pmatrix} - \lambda \begin{pmatrix} 7 \\ 5 \end{pmatrix}$
 - (c) $\mathbf{r} = -\begin{pmatrix} 2 \\ 4 \end{pmatrix} + \lambda \begin{pmatrix} 1 \\ 8 \end{pmatrix}$
 - (d) $\mathbf{r} = \begin{pmatrix} 0.5 \\ 0.2 \end{pmatrix} - t \begin{pmatrix} -1 \\ 11 \end{pmatrix}$
 - (e) $\mathbf{r} = \begin{pmatrix} 7 \\ 5 \end{pmatrix} + \lambda \begin{pmatrix} 0 \\ 1 \end{pmatrix}$
 - (f) $\mathbf{r} = \begin{pmatrix} 2 \\ 6 \end{pmatrix} + \lambda \begin{pmatrix} 5 \\ 0 \end{pmatrix}$

7. Write the following lines in vector form
 - (a) $y = \frac{1}{3}x + 2$
 - (b) $y = x - 5$
 - (c) $2y - x = 6$

8. Find the position vector of the point of intersection of each pair of lines.
 - (a) $\mathbf{r}_1 = \begin{pmatrix} 2 \\ 1 \end{pmatrix} + \begin{pmatrix} \lambda \\ 3\lambda \end{pmatrix}$ and $\mathbf{r}_2 = \begin{pmatrix} 1 \\ 3 \end{pmatrix} + \mu \begin{pmatrix} 1 \\ 2 \end{pmatrix}$.
 - (b) $\mathbf{r}_1 = \begin{pmatrix} 0 \\ 4 \end{pmatrix} + \lambda \begin{pmatrix} 2 \\ 5 \end{pmatrix}$ and $\mathbf{r}_2 = \begin{pmatrix} 2 \\ -2 \end{pmatrix} + \mu \begin{pmatrix} 1 \\ 1 \end{pmatrix}$.

9. Find the equation of the line that passes through the point $A(2, 7)$ and is perpendicular to the line with equation $\mathbf{r} = -\mathbf{i} - 3\mathbf{j} + \lambda(3\mathbf{i} - 4\mathbf{j})$.
10. Let the position vectors of the points $P(x_1, y_1)$ and $Q(x_2, y_2)$ be \mathbf{p} and \mathbf{q} respectively. Show that the equation $\mathbf{r} = (1 - \lambda)\mathbf{p} + \lambda\mathbf{q}$ represents a vector equation of the line through P and Q , where $\lambda \in \mathbb{R}$.
11. The line L is defined by the parametric equations $x = 4 - 5k$ and $y = -2 + 3k$.
- Find the coordinates of three points on L .
 - Find the value of k that corresponds to the point $(14, -8)$.
 - Show that the point $(-1, 4)$ does not lie on the line L .
 - Find the vector form of the line L .
 - A second line, M , is defined parametrically by $x = a + 10\lambda$ and $y = b - 6\lambda$. Describe the relationship between M and L for the case that
 - $a = 8$ and $b = 4$
 - $a = 4$ and $b = -2$
12. Find the cartesian equation of the line that passes through the point $A(2, 1)$ and such that it is perpendicular to the vector $4\mathbf{i} + 3\mathbf{j}$.
13. Find the direction cosines for each of the following lines
- $\mathbf{r} = \begin{pmatrix} 3 \\ 4 \end{pmatrix} + \mu \begin{pmatrix} -3 \\ 2 \end{pmatrix}$
 - $\mathbf{r} = \begin{pmatrix} 5 \\ 9 \end{pmatrix} + \lambda \begin{pmatrix} 4 \\ 3 \end{pmatrix}$
14. (a) Show that the line $ax + by + c = 0$ has a directional vector $\begin{pmatrix} b \\ -a \end{pmatrix}$ and a normal vector $\begin{pmatrix} a \\ b \end{pmatrix}$.
- (b) By making use of directional vectors, which of the following lines are parallel to $L : 2x + 3y = 10$?
- $5x - 2y = 10$
 - $6x + 9y = 20$
 - $4x + 6y = -10$
15. Find the point of intersection of the lines $\mathbf{r} = \begin{pmatrix} -2 \\ 1 \end{pmatrix} + \lambda \begin{pmatrix} 3 \\ 8 \end{pmatrix}$ and $\frac{x-3}{2} = \frac{y}{5}$.
16. Find a vector equation of the line passing through the origin that also passes through the point of intersection of the lines $\mathbf{u} = \begin{pmatrix} 3 \\ 2 \end{pmatrix} + \lambda \begin{pmatrix} -1 \\ 3 \end{pmatrix}$ and $\mathbf{v} = \begin{pmatrix} -1 \\ 1 \end{pmatrix} + \mu \begin{pmatrix} 2 \\ 1 \end{pmatrix}$.
17. Consider the line with vector equation $\mathbf{r} = (4\mathbf{i} - 3\mathbf{j}) + \lambda(3\mathbf{i} + 4\mathbf{j})$. Find the point(s) of intersection of this line with the line
- $\mathbf{u} = (4\mathbf{i} + 5\mathbf{j}) + \mu(2\mathbf{i} - \mathbf{j})$
 - $\mathbf{v} = (-2\mathbf{i} + 3\mathbf{j}) + t(-6\mathbf{i} - 8\mathbf{j})$
 - $\mathbf{w} = (13\mathbf{i} + 9\mathbf{j}) + s(3\mathbf{i} + 4\mathbf{j})$

26.7.2 LINES IN THREE DIMENSIONS

In three dimensional work always try to visualise situations very clearly. Because diagrams are never very satisfactory, it is useful to use the corner of a table with an imagined vertical line for axes; then pencils become lines and books or sheets of paper become planes.

It is tempting to generalise from a two dimensional line like $x + y = 8$ and think that the Cartesian equation of a three dimensional line will have the form $x + y + z = 8$. This is not correct - as we will see later **this represents a plane, not a line**.

We approach lines in three dimensions in exactly the same way that we did for lines in two dimensions. For any point $P(x,y,z)$ on the line having the position vector \mathbf{r} , passing through the point A and parallel to a vector in the direction of the line, \mathbf{b} say, we can write the equation of the

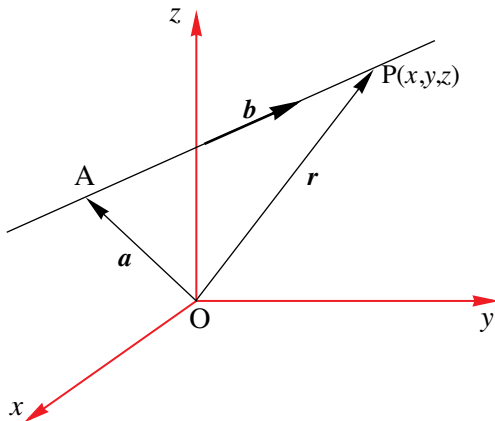

the line as $\mathbf{r} = \mathbf{a} + \lambda \mathbf{b}$.

So, for example, the line passing through the point $(4, 2, 5)$ and having the direction vector $\mathbf{i} - \mathbf{j} + 2\mathbf{k}$ can be written as:

$$\mathbf{r} = \begin{pmatrix} 4 \\ 2 \\ 5 \end{pmatrix} + \lambda \begin{pmatrix} 1 \\ -1 \\ 2 \end{pmatrix}.$$

Or, it could also have been written in $\mathbf{i}, \mathbf{j}, \mathbf{k}$ form as $\mathbf{r} = 4\mathbf{i} + 2\mathbf{j} + 5\mathbf{k} + \lambda(\mathbf{i} - \mathbf{j} + 2\mathbf{k})$.

As for the case in 2-D, the parametric form or Cartesian form of the equation is obtained by using

a point $P(x, y, z)$ on the line with position vector $\mathbf{r} = \begin{pmatrix} x \\ y \\ z \end{pmatrix}$ so that $\begin{pmatrix} x \\ y \\ z \end{pmatrix} = \begin{pmatrix} 4 \\ 2 \\ 5 \end{pmatrix} + \lambda \begin{pmatrix} 1 \\ -1 \\ 2 \end{pmatrix}$.

From where we first get the **parametric equations**:

$$x = 4 + \lambda, \quad y = 2 - \lambda \quad \text{and} \quad z = 5 + 2\lambda.$$

Solving each of these for λ we get: $\lambda = x - 4 = 2 - y = \frac{z - 5}{2}$.

The parameter λ plays no part in the Cartesian equation, so we drop it and write the

Cartesian equation as $x - 4 = 2 - y = \frac{z - 5}{2}$.

It is important to be clear what this means: if we choose x, y and z satisfying the Cartesian equation, then the point $P(x, y, z)$ will be on the line.

For example $x = 10, y = -4$ and $z = 17$ satisfies the Cartesian equation, and if we think back to our

original parametric equation we can see that $\begin{pmatrix} 10 \\ -4 \\ 17 \end{pmatrix} = \begin{pmatrix} 4 \\ 2 \\ 5 \end{pmatrix} + 6 \begin{pmatrix} 1 \\ -1 \\ 2 \end{pmatrix}$.

To convert a Cartesian equation into parametric form we reverse the process and introduce a parameter λ . For example if the Cartesian equation is $\frac{x-1}{3} = \frac{y+2}{2} = \frac{z-6}{4}$ we write:

$$\frac{x-1}{3} = \frac{y+2}{2} = \frac{z-6}{4} = \lambda$$

$$\Rightarrow x = 1 + 3\lambda$$

$$y = -2 + 2\lambda$$

$$z = 6 + 4\lambda$$

$$\text{and } \mathbf{r} = \begin{pmatrix} 1 \\ -2 \\ 6 \end{pmatrix} + \lambda \begin{pmatrix} 3 \\ 2 \\ 4 \end{pmatrix}$$

You will probably have noticed the strong connection between the numbers in the fractions in the Cartesian form and the numbers in the vectors in the parametric form.

Consider the **Cartesian form** of any straight L passing through the point $P(x_1, y_1, z_1)$:

$$\frac{x-x_1}{a} = \frac{y-y_1}{b} = \frac{z-z_1}{c}$$

From this equation we obtain the **parametric form** of the straight line:

$$\frac{x-x_1}{a} = \lambda \Leftrightarrow x = x_1 + \lambda a$$

$$\frac{y-y_1}{b} = \lambda \Leftrightarrow y = y_1 + \lambda b$$

$$\frac{z-z_1}{c} = \lambda \Leftrightarrow z = z_1 + \lambda c$$

which then leads to the **vector form** of the straight line:

$$\begin{pmatrix} x \\ y \\ z \end{pmatrix} = \begin{pmatrix} x_1 \\ y_1 \\ z_1 \end{pmatrix} + \lambda \begin{pmatrix} a \\ b \\ c \end{pmatrix}$$

That is, the denominators of the Cartesian form of a straight line provide the coefficients of the directional vector of the line. This is an important observation, especially when finding the angle between two lines when the equation of the line is provided in Cartesian form.

However, rather than simply committing this observation to memory it is always a good idea to go through the (very short) working involved.

EXAMPLE 26.31

Find the Cartesian form of the straight line passing through the point $(4,6,3)$ and having direction vector $3\mathbf{i} - 2\mathbf{j} + \mathbf{k}$. Draw a sketch of this line on a set of axes.

S
o
l
u
t
i
o
n

We start by sketching the line:

The direction vector of the line is $3\mathbf{i} - 2\mathbf{j} + \mathbf{k}$ and as the line passes through the point $(4,6,3)$, the vector equation of the line is given by

$$\mathbf{r} = (4\mathbf{i} + 6\mathbf{j} + 3\mathbf{k}) + \lambda(3\mathbf{i} - 2\mathbf{j} + \mathbf{k}).$$

From the vector equation we obtain the parametric form of the line:

$$x = 4 + 3\lambda, y = 6 - 2\lambda \text{ and } z = 3 + \lambda.$$

From these equations we have, $\lambda = \frac{x-4}{3}$, $\lambda = \frac{y-6}{-2}$ and $\lambda = \frac{z-3}{1}$

Then, eliminating λ we have $\frac{x-4}{3} = \frac{y-6}{-2} = \frac{z-3}{1}$ or $\frac{x-4}{3} = \frac{y-6}{-2} = z-3$.

Which represents the Cartesian form of the line.

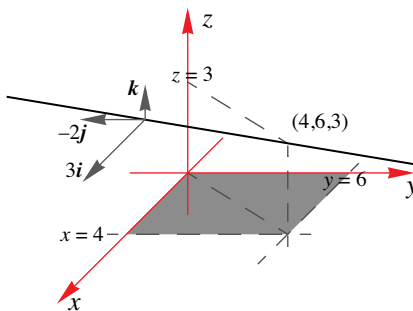

EXAMPLE 26.32

Find the vector form of the equation of the line through the point $A(2,1,1)$ and the point $B(4,0,3)$.

S
o
l
u
t
i
o
n

We make a very rough sketch - there is no point in trying to plot A and B accurately. Let the position vector of any point P on the line be \mathbf{r} .

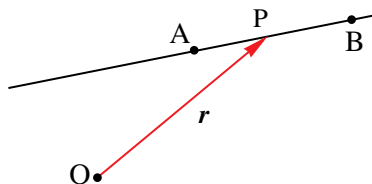

Then the vector form of the line is $\mathbf{r} = \mathbf{OA} + \lambda\mathbf{AB}$.

Now, $\mathbf{OP} = \mathbf{r} = \mathbf{OA} + \lambda\mathbf{AB}$.

But $\mathbf{AP} = \lambda\mathbf{AB} \therefore \mathbf{r} = \mathbf{OA} + \lambda\mathbf{AB}$ and $\mathbf{AB} = \mathbf{AO} + \mathbf{OB} = -\mathbf{OA} + \mathbf{OB}$

$$\therefore \mathbf{AB} = -\begin{pmatrix} 2 \\ 1 \\ 1 \end{pmatrix} + \begin{pmatrix} 4 \\ 0 \\ 3 \end{pmatrix} = \begin{pmatrix} 2 \\ -1 \\ 2 \end{pmatrix} \text{ and so, } \mathbf{r} = \begin{pmatrix} 2 \\ 1 \\ 1 \end{pmatrix} + \lambda \begin{pmatrix} 2 \\ -1 \\ 2 \end{pmatrix}.$$

EXAMPLE 26.33

Find the acute angle between the straight lines

$$L_1: \frac{x-3}{2} = \frac{y+2}{-1} = \frac{z}{\sqrt{3}} \text{ and } L_2: \frac{x+1}{1} = \frac{y-2}{1} = \frac{z-1}{\sqrt{3}}$$

S
o
l
u
t
i
o
n

Because the lines are given in their standard Cartesian form, we know that the denominators represent the coefficients of the direction vectors of these lines. As the angle between the lines is the same as the angle between their direction vectors we need only use the direction vectors of each line and then apply the dot product.

For L_1 the direction vector is $\mathbf{b}_1 = 2\mathbf{i} - \mathbf{j} + \sqrt{3}\mathbf{k}$ and for L_2 it is $\mathbf{b}_2 = \mathbf{i} + \mathbf{j} + \sqrt{3}\mathbf{k}$.

Using the dot product we have:

$$\begin{aligned} \mathbf{b}_1 \cdot \mathbf{b}_2 &= |\mathbf{b}_1||\mathbf{b}_2|\cos\theta \quad \therefore (2\mathbf{i} - \mathbf{j} + \sqrt{3}\mathbf{k}) \cdot (\mathbf{i} + \mathbf{j} + \sqrt{3}\mathbf{k}) = \sqrt{8} \times \sqrt{5} \cos\theta \\ 2 - 1 + 3 &= \sqrt{40} \cos\theta \\ \cos\theta &= \frac{4}{\sqrt{40}} \\ \therefore \theta &= 50^\circ 46' \end{aligned}$$

EXAMPLE 26.34

Write the equation of the line $\frac{x+1}{3} = \frac{4-y}{2} = z$ in parametric form, and show that it is parallel to $-\mathbf{i} + 5\mathbf{j} + \mathbf{k} + \mu(-6\mathbf{i} + 4\mathbf{j} - 2\mathbf{k})$.

S
o
l
u
t
i
o
n

From the Cartesian form of the line $\frac{x+1}{3} = \frac{4-y}{2} = z = \lambda$ (say) we obtain the parametric form $x = -1 + 3\lambda, y = 4 - 2\lambda$ and $z = \lambda$.

We can then write this in the vector form $\mathbf{r} = -\mathbf{i} + 4\mathbf{j} + \lambda(3\mathbf{i} - 2\mathbf{j} + \mathbf{k})$.

Comparing the direction vectors of the two lines we see that $-6\mathbf{i} + 4\mathbf{j} - 2\mathbf{k} = -2(3\mathbf{i} - 2\mathbf{j} + \mathbf{k})$, and so the direction vectors (and hence the lines) are parallel.

It is worth emphasising, that lines will be parallel or perpendicular if their direction vectors are parallel or perpendicular.

Consider the two lines, $L_1 : \mathbf{r}_1 = \mathbf{a}_1 + \lambda\mathbf{b}_1$ and $L_2 : \mathbf{r}_2 = \mathbf{a}_2 + \lambda\mathbf{b}_2$, with directions vectors $\mathbf{b}_1 = x_1\mathbf{i} + y_1\mathbf{j} + z_1\mathbf{k}$ and $\mathbf{b}_2 = x_2\mathbf{i} + y_2\mathbf{j} + z_2\mathbf{k}$ respectively, then

1. If the two lines are perpendicular we have $\mathbf{b}_1 \cdot \mathbf{b}_2 = 0 \Rightarrow x_1x_2 + y_1y_2 + z_1z_2 = 0$.
2. If the two lines are parallel we have $\mathbf{b}_1 = m\mathbf{b}_2, m \neq 0$ which in turn implies that $x_1 = mx_2, y_1 = my_2$ and $z_1 = mz_2$. Then, eliminating the constant m , we have that

$$L_1 \parallel L_2 \Leftrightarrow \frac{x_1}{x_2} = \frac{y_1}{y_2} = \frac{z_1}{z_2}$$

EXAMPLE 26.35

Line L passes through the points (4, 3, 9) and (7, 8, 5), while line M passes through the points (12, 16, 4) and (k, 26, -4), where $k \in \mathbb{R}$. Find the value(s) of k, if

- (a) L is parallel to M.
- (b) L is perpendicular to M.

We first need to determine direction vectors for both L and M.

For L: Let the points be A(4, 3, 9) and B(7, 8, 5), then a direction vector for L,

$$\mathbf{b}_1 \text{ (say), is given by } \mathbf{b}_1 = \begin{pmatrix} 7-4 \\ 8-3 \\ 5-9 \end{pmatrix} = \begin{pmatrix} 3 \\ 5 \\ -4 \end{pmatrix}.$$

For M: Let the points be X(12, 16, 4) and Y(k, 26, -4), then a direction vector for M,

$$\mathbf{b}_2 \text{ (say), is given by } \mathbf{b}_2 = \begin{pmatrix} k-12 \\ 26-16 \\ -4-4 \end{pmatrix} = \begin{pmatrix} k-12 \\ 10 \\ -8 \end{pmatrix}.$$

(a) If $L \parallel M$ we must have that $\mathbf{b}_1 = c\mathbf{b}_2, c \in \mathbb{R}$.

$$\text{i.e., } \begin{pmatrix} 3 \\ 5 \\ -4 \end{pmatrix} = c \begin{pmatrix} k-12 \\ 10 \\ -8 \end{pmatrix} \Rightarrow \frac{3}{k-12} = \frac{5}{10} = \frac{-4}{-8}$$

$$\text{So that } \frac{3}{k-12} = \frac{1}{2} \Leftrightarrow k-12 = 6 \Leftrightarrow k = 18.$$

(b) If $L \perp M$ we must have that $\mathbf{b}_1 \cdot \mathbf{b}_2 = 0$.

$$\text{i.e., } \begin{pmatrix} 3 \\ 5 \\ -4 \end{pmatrix} \cdot \begin{pmatrix} k-12 \\ 10 \\ -8 \end{pmatrix} = 0 \Rightarrow 3(k-12) + 50 + 32 = 0$$

$$\Leftrightarrow 3k = -46 \Leftrightarrow k = -\frac{46}{3}$$

Intersection of 2 lines in 3-D

Two lines in space may

1. intersect at a point, or
2. be parallel and never intersect, or
3. be parallel and coincident (i.e., the same), or
4. be neither parallel nor intersect.

Of the above scenarios, the first three are consistent with our findings when dealing with lines in a plane (i.e., 2-D), however, the fourth scenario is new. We illustrate these now.

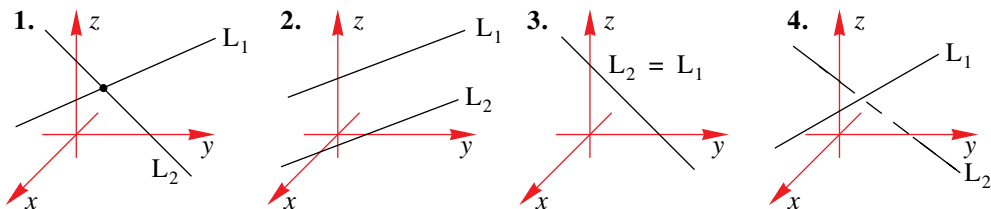

Two lines that meet at (at least) one point must lie in the same plane (cases 1. and 3.) Two intersecting lines or two parallel lines are said to be **coplanar** (cases 1., 2., and 3.). Two lines which are not parallel and which do not intersect are said to be **skew** – skew lines do not lie on the same plane – i.e., they are not coplanar. (case 4.)

Lines lying on the xy -, xz - and yz - planes

From the Cartesian form of the straight line, $L: \frac{x-x_1}{a} = \frac{y-y_1}{b} = \frac{z-z_1}{c}$ we can write:

$$\frac{x-x_1}{a} = \frac{y-y_1}{b} \Leftrightarrow b(x-x_1) = a(y-y_1) \quad (1)$$

$$\frac{x-x_1}{a} = \frac{z-z_1}{c} \Leftrightarrow c(x-x_1) = a(z-z_1) \quad (2)$$

$$\frac{y-y_1}{b} = \frac{z-z_1}{c} \Leftrightarrow c(y-y_1) = b(z-z_1) \quad (3)$$

Equations (1), (2) and (3) represent the planes perpendicular to the xy -, xz - and yz planes respectively. Each of these equations is an equation of a plane containing L . The simultaneous solution of any pair of these planes will produce the same line. In fact, the three equations are not independent because any one of them can be derived from the other two.

If any one of the numbers a, b or c is zero we obtain a line lying in one of the xy -, xz - or yz planes. For example, consider the case that $c = 0$ and neither a nor b is zero.

In such a case we have, $\frac{x-x_1}{a} = \frac{y-y_1}{b}$ and $z = z_1$ meaning that the line lies on the plane containing the point $z = z_1$ and parallel to the xy -plane.

$$\frac{x-x_1}{a} = \frac{y-y_1}{b} \text{ and } z = z_1$$

For ‘convenience’ we sometimes write the

$$\text{equation as } \frac{x-x_1}{a} = \frac{y-y_1}{b} = \frac{z-z_1}{0},$$

although clearly, $\frac{z-z_1}{0}$ has no meaning.

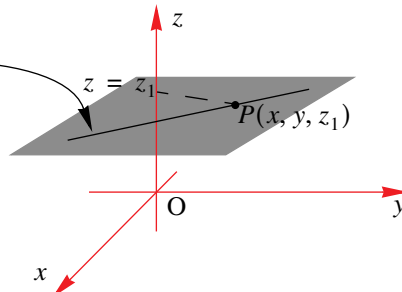

EXAMPLE 26.36

Line L passes through the points $A(1,2,-1)$ and $B(11,-2,-7)$ while line M passes through the points $C(2,-1,-3)$ and $D(9,-10,3)$. Show that L and M are skew lines.

Solution

We start by finding the vector equations of both lines.

For L we have a direction vector given by

$$\mathbf{b}_1 = (11-1)\mathbf{i} + (-2-2)\mathbf{j} + (-7-(-1))\mathbf{k} = 10\mathbf{i} - 4\mathbf{j} - 6\mathbf{k}$$

Then, as L passes through $A(1,2,-1)$, it has a vector equation given by

$$\mathbf{r} = \mathbf{i} + 2\mathbf{j} - \mathbf{k} + \lambda(10\mathbf{i} - 4\mathbf{j} - 6\mathbf{k})$$

This gives the parametric form as, $x = 1 + 10\lambda$, $y = 2 - 4\lambda$ and $z = -1 - 6\lambda$ – (1)
Similarly, we can find the parametric form for M .

MATHEMATICS – Higher Level (Core)

The vector form of M is given by $\mathbf{r} = 2\mathbf{i} - \mathbf{j} - 3\mathbf{k} + \mu(7\mathbf{i} - 9\mathbf{j} + 6\mathbf{k})$

So that the parametric form is given by $x = 2 + 7\mu$, $y = -1 - 9\mu$ and $z = -3 + 6\mu$ – (2)

Now, as the set of coefficients of the direction vector of M and L are not proportional,

$$\text{i.e., as } \frac{10}{7} \neq \frac{-4}{-9} \neq \frac{-6}{6}$$

the lines L and M are not parallel.

Then, for the lines to intersect there must be a value of λ and μ that will provide the same point (x_0, y_0, z_0) lying on both L and M. Using (1) and (2) we equate the coordinates and try to determine this point (x_0, y_0, z_0) :

$$1 + 10\lambda = 2 + 7\mu \quad - (3)$$

$$2 - 4\lambda = -1 - 9\mu \quad - (4)$$

$$-1 - 6\lambda = -3 + 6\mu \quad - (5)$$

Solving for λ and μ using (4) and (5) we obtain: $\mu = -\frac{5}{39}$ and $\lambda = \frac{18}{39}$.

Substituting these values into (1), we have L.H.S = $1 + 10 \times \frac{18}{39} \neq 2 + 7 \times -\frac{5}{39} = \text{R.H.S.}$

As the first equation is not consistent with the other two, the lines do not intersect and as they are not parallel they must be skew.

EXERCISES 26.7.2

- Find the vector form of the line passing through the point
(a) $A(2, 1, 3)$ which is also parallel to the vector $\mathbf{i} - 2\mathbf{j} + 3\mathbf{k}$.
(b) $A(2, -3, -1)$ which is also parallel to the vector $-2\mathbf{i} + \mathbf{k}$.

- Find the vector form of the line passing through the points
(a) $A(2, 0, 5)$ and $B(3, 4, 8)$.
(b) $A(3, -4, 7)$ and $B(7, 5, 2)$.
(c) $A(-3, 4, -3)$ and $B(4, 4, 4)$.

- Find the Cartesian form of the line having the vector form

$$(a) \quad \mathbf{r} = \begin{pmatrix} 0 \\ 2 \\ 3 \end{pmatrix} + s \begin{pmatrix} 3 \\ 4 \\ 5 \end{pmatrix} \quad (b) \quad \mathbf{r} = \begin{pmatrix} -2 \\ 3 \\ -1 \end{pmatrix} + t \begin{pmatrix} 5 \\ 0 \\ -2 \end{pmatrix} \quad (c) \quad \mathbf{r} = \begin{pmatrix} 0 \\ 0 \\ 0 \end{pmatrix} + s \begin{pmatrix} 1 \\ 1 \\ 1 \end{pmatrix}$$

- Find the Cartesian equation of the line passing through the points $A(5, 2, 6)$ and $B(-2, 4, 2)$. Also, provide the parametric form of this line.
- For the line defined by the parametric equations $x = 3 + 2t$, $y = 4 - 3t$ and $z = 1 + 5t$ find the coordinates of where the line crosses the xy -plane.

6. Convert these lines to their parametric form.

(a) $\frac{x-2}{3} = y-5 = 2(z-4)$

(b) $\frac{2x-1}{3} = y = \frac{4-z}{2}$

(c) $\frac{x-3}{-1} = \frac{2-y}{3} = \frac{z-4}{2}$

(d) $\frac{2x-2}{4} = \frac{3-y}{-2} = \frac{2z-4}{1}$

7. Convert these lines to their Cartesian form:

(a) $\mathbf{r} = \begin{pmatrix} 4 \\ 1 \\ -2 \end{pmatrix} + t \begin{pmatrix} 3 \\ -4 \\ -2 \end{pmatrix}$

(b) $\mathbf{r} = 2\mathbf{i} + \mathbf{k} + \mu(\mathbf{j} - 3\mathbf{k})$

8. Show that the lines $\frac{x-1}{2} = 2-y = 5-z$ and $\frac{4-x}{4} = \frac{3+y}{2} = \frac{5+z}{2}$ are parallel.

9. Find the Cartesian equation of the lines joining the points

(a) $(-1, 3, 5)$ to $(1, 4, 4)$

(b) $(2, 1, 1)$ to $(4, 1, -1)$

10. (a) Find the coordinates of the point where the line $\mathbf{r} = \begin{pmatrix} -2 \\ 5 \\ 3 \end{pmatrix} + t \begin{pmatrix} -1 \\ 2 \\ 1 \end{pmatrix}$ intersects the

x - y plane.

(b) The line $\frac{x-3}{4} = y+2 = \frac{4-z}{5}$ passes through the point $(a, 1, b)$. Find the values of a and b .

11. Find the Cartesian equation of the line having the vector form

(a) $\mathbf{r} = \begin{pmatrix} 1 \\ 4 \\ -2 \end{pmatrix} + t \begin{pmatrix} 1 \\ -1 \\ 0 \end{pmatrix}$

(b) $\mathbf{r} = \begin{pmatrix} 2 \\ 1 \\ 3 \end{pmatrix} + t \begin{pmatrix} 2 \\ 0 \\ 0 \end{pmatrix}$.

In each case, provide a diagram showing the lines.

12. Find the vector equation of the line represented by the Cartesian form

$$\frac{x-1}{2} = \frac{1-2y}{3} = z-2.$$

Clearly describe this line.

13. Find the acute angle between the following lines

(a) $\mathbf{r} = \begin{pmatrix} 0 \\ 2 \\ 3 \end{pmatrix} + s \begin{pmatrix} 3 \\ 4 \\ 5 \end{pmatrix}$ and $\mathbf{r} = \begin{pmatrix} -2 \\ 5 \\ 3 \end{pmatrix} + t \begin{pmatrix} -1 \\ 2 \\ 1 \end{pmatrix}$.

(b) $\mathbf{r} = \begin{pmatrix} 2 \\ 1 \\ 4 \end{pmatrix} + s \begin{pmatrix} -2 \\ 0 \\ 1 \end{pmatrix}$ and $\mathbf{r} = \begin{pmatrix} 1 \\ 1 \\ 1 \end{pmatrix} + s \begin{pmatrix} 1 \\ 1 \\ 3 \end{pmatrix}$

(c) $\frac{x-3}{-1} = \frac{2-y}{3} = \frac{z-4}{2}$ and $\frac{x-1}{2} = \frac{y-2}{-2} = z-2$

MATHEMATICS – Higher Level (Core)**14.** Find the point of intersection of the lines

(a) $\frac{x-5}{-2} = y-10 = \frac{z-9}{12}$ and $x = 4, \frac{y-9}{-2} = \frac{z+9}{6}$

(b) $\frac{2x-1}{3} = \frac{y+5}{3} = \frac{z-1}{-2}$ and $\frac{2-x}{4} = \frac{y+3}{2} = \frac{4-2z}{1}$

15. (a) Find the Cartesian form of the lines with parametric equation given by

$$L : x = \lambda, y = 2\lambda + 2, z = 5\lambda \quad \text{and}$$

$$M : x = 2\mu - 1, y = -1 + 3\mu, z = 1 - 2\mu$$

(b) Find the point of intersection of these two lines.

(c) Find the acute angle between these two lines.

(d) Find the coordinates of the point where
i. L cuts the x - y plane.
ii. M cuts the y - z plane.**16.** Show that the lines $\frac{x-2}{3} = \frac{y-3}{-2} = \frac{z+1}{5}$ and $\frac{x-5}{-3} = \frac{y-1}{2} = \frac{z-4}{-5}$ are coincident.**17.** Show that the lines $\frac{x-1}{-3} = y-2 = \frac{7-z}{11}$ and $\frac{x-2}{3} = \frac{y+1}{8} = \frac{z-4}{-7}$ are skew.**18.** Find the equation of the line passing through the origin and the point of intersection of the lines with equations $x-2 = \frac{y-1}{4}, z = 3$ and $\frac{x-6}{2} = y-10 = z-4$.**19.** The lines $\frac{x}{3} = \frac{y-2}{4} = 3+z$ and $x = y = \frac{z-1}{2k}, k \in \mathbb{R} \setminus \{0\}$ meet at right angles. Find k .**20.** Consider the lines $L : x = 0, \frac{y-3}{2} = z+1$ and $M : \frac{x}{4} = \frac{y}{3} = \frac{z-10}{-1}$.
Find, correct to the nearest degree, the angle between the lines L and M.**21.** Find the value(s) of k , such that the lines $\frac{x-2}{k} = \frac{y}{2} = \frac{3-z}{3}$ and $\frac{x}{k-1} = \frac{y+2}{3} = \frac{z}{4}$ are perpendicular.**22.** Find a direction vector of the line that is perpendicular to both $\frac{x+1}{3} = \frac{y+1}{8} = \frac{z+1}{12}$
and $\frac{1-2x}{-4} = \frac{3y+1}{9} = \frac{z}{6}$.**23.** Are the lines $\frac{x-1}{5} = \frac{y+2}{4} = \frac{4-z}{3}$ and $\frac{x+2}{3} = \frac{y+7}{2} = \frac{2-z}{3}$ parallel? Find the point of intersection of these lines. What do you conclude?

27.1 VECTOR PRODUCT

We start this section by establishing a ‘definition’.

RIGHT HANDED SYSTEM

When dealing with three-dimensional space, three base vectors (not coplanar) must be defined. We also conveniently use base vectors that are mutually orthogonal (at right-angles) and which are **right-handed**.

So, what do we mean by right-handed?

If we place a screw at some origin O and rotate it from OX to OY , then the screw would move in the direction OZ . This defines what is known as a **right-handed system**. This definition becomes important when we look at the operation of **vector product**.

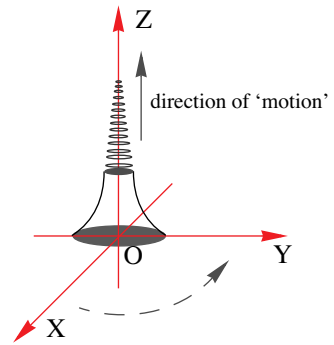

27.1.1 VECTOR PRODUCT

Unlike the scalar product of two vectors, which results in a scalar value, the **vector product** or as it is often called, the **cross product**, produces a vector.

We define the vector product as follows

The vector product (or cross product) of two vectors, \mathbf{a} and \mathbf{b} produces a third vector, \mathbf{c} , where

$$\mathbf{c} = \mathbf{a} \times \mathbf{b} = |\mathbf{a}||\mathbf{b}|\sin\theta\hat{\mathbf{n}}$$

and θ is the angle between \mathbf{a} and \mathbf{b} and $\hat{\mathbf{n}}$ is a unit vector perpendicular to both \mathbf{a} and \mathbf{b} , i.e., to the plane of $\mathbf{a} \times \mathbf{b}$. This means that the vectors \mathbf{a} , \mathbf{b} and $\hat{\mathbf{n}}$ (**in that order**) form a right-handed system.

We now consider some properties of the vector product.

1. Direction of $\mathbf{a} \times \mathbf{b}$

The resulting vector, $\mathbf{c} = \mathbf{a} \times \mathbf{b}$ is a vector that is parallel to the unit vector $\hat{\mathbf{n}}$ (unless $\mathbf{a} \times \mathbf{b} = \mathbf{0}$).

The direction of $\hat{\mathbf{n}}$ (and hence \mathbf{c}) is always either

- perpendicular to the plane containing \mathbf{a} and \mathbf{b} which is **determined by the right-hand rule** (as shown in the diagram).

or

- is the zero vector, $\mathbf{0}$.

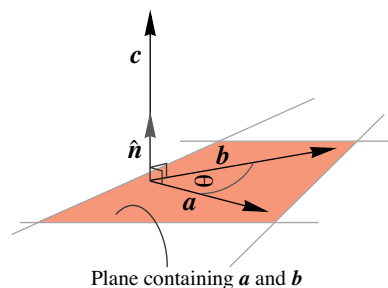

2. Magnitude of $a \times b$

The magnitude of $a \times b$ is given by $|a \times b| = ||a||b| \sin \theta \hat{n}$
 $= |a||b| \sin \theta ||\hat{n}|$

But, $|\hat{n}| = 1$ and $0 \leq \theta \leq \pi \Rightarrow \sin \theta \geq 0$, therefore, we have that

$$|a \times b| = |a||b| \sin \theta$$

Notice that from 1., and 2., we can also conclude that

If $a \times b = \mathbf{0}$, then either

1.	$a = \mathbf{0}$ or $b = \mathbf{0}$ or both a and b are $\mathbf{0}$
or 2.	$\sin \theta = 0 \Rightarrow \theta = 0$ or π (as $0 \leq \theta \leq \pi$).

Observation 2., i.e., $\sin \theta = 0 \Rightarrow \theta = 0$ or π , implies that a and b would be either parallel or antiparallel, which would not define a plane and so, the unit vector would not be defined.

This means that for any vector, a , $a \times a = \mathbf{0}$, which brings up a very interesting result for our i - j - k – vector system:

$$i \times i = j \times j = k \times k = \mathbf{0}.$$

So, unlike the scalar product, where $a \cdot a = |a|^2 > 0$ for a non-zero vector a , with the cross product we have $a \times a = \mathbf{0}$. Also, recall that with the dot product, if the vectors a and b are non-zero and perpendicular, then $a \cdot b = 0$. So, what can we conclude about the cross product of two non-zero perpendicular vectors?

If the non-zero vectors a and b are perpendicular then $\theta = \frac{\pi}{2} \Rightarrow \sin \theta = 1 \therefore a \times b = |a||b|\hat{n}$.

This means that the magnitude of $|a \times b| = |a||b||\hat{n}| = |a||b|$.

As a result of this property, we have for our i - j - k – vector system the following results

$$i \times j = k, j \times k = i, k \times i = j$$

$$i \times k = -j, j \times i = -k, k \times j = -i$$

and

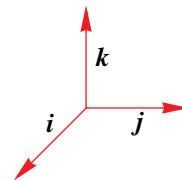

The reason for the the negative signs in the above is to ensure consistency within the right-hand system.

So that for example, the vectors i, j and k (in that order) form a right-hand system as do the vectors i, k and $-j$ (in that order). A useful way of remembering which sign applies is to use the cyclic diagram shown:

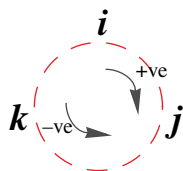

1. Going **clockwise**, we take the **positive sign**,
e.g., $k \times i = j$
2. Going **anticlockwise**, we take the **negative sign**,
e.g., $j \times i = -k$

3. Operational properties

Closure As $a \times b$ produces a unique vector, then the operation of vector product is closed.

Commutative As $a \times b = -b \times a$ (to conform with the right-hand system) the operation of vector product is **not** commutative.

In fact, because of the change in sign, we say that the vector product is anti-commutative.

Notice also that $|a \times b| = |-b \times a| = |b \times a|$, i.e., the vector $a \times b$ has the same magnitude as $b \times a$ but is in the opposite direction.

Associative It is easy to verify that $(a \times b) \times c \neq a \times (b \times c)$ (e.g., use $a = i, b = j$ and $c = k$) and so the vector product is **non-associative**.

Distributive It is easy to verify that $a \times (b + c) = a \times b + a \times c$ and as such, the vector product is **distributive over addition**.

Identity **No identity** element exists for the operation of vector product.

Inverse **No inverse** element exists for the operation of vector product.

EXERCISES 27.1.1

1. For each pair of coplanar vectors, find the magnitude of their cross product.

- (a) $|a| = 5, |b| = 2$ and the angle between a and b is 30° .
- (b) $|u| = 1, |v| = 8$ and the angle between u and v is 60° .
- (c) $|a| = 3, |b| = 4$ where a and b are parallel.
- (d) $|u| = 0.5, |v| = 12$, where u and v are perpendicular.
- (e) $|a| = 7, |b| = 3$ and a and b are anti-parallel.

2. Sketch the following cross products for each pair of coplanar vectors.

(a)

$|a| = 2, |b| = 3$

Where a and b can be considered as lying on the surface of an upright table.

(b)

$|a| = 4, |b| = 3$

(c)

$|a| = 2, |b| = 2$

- i. $a \times b$ ii. $b \times a$ iii. $a \times a$

MATHEMATICS – Higher Level (Core)

3. i. If $|a| = 5$, $|b| = 4$ and $a \cdot b = 6$, find $|a \times b|$.
 ii. If $|a| = 5$, $|b| = 4$ and $a \cdot b = 12$, find $|a \times b|$.
4. If $|a| = 2$, $|b| = 9$ and $|a \times b| = 15$, find the angle between the vectors a and b .
5. If $|a| = 3$, $|b| = 3$ and $|a \times b| = 6$, find $a \cdot b$.
6. If $|a| = 1$, $|b| = \sqrt{3}$ where a and b are mutually perpendicular, find
 i. $|(a + b) \times (a - b)|$.
 ii. $|(2a + b) \times (a - 2b)|$.

27.1.2 VECTOR FORM OF THE VECTOR PRODUCT

1. Component form

The vector product is only defined when both vectors are three dimensional.

The vector product of $a = \begin{pmatrix} a_1 \\ a_2 \\ a_3 \end{pmatrix}$ and $b = \begin{pmatrix} b_1 \\ b_2 \\ b_3 \end{pmatrix}$ is

given by:
$$a \times b = \begin{pmatrix} a_1 \\ a_2 \\ a_3 \end{pmatrix} \times \begin{pmatrix} b_1 \\ b_2 \\ b_3 \end{pmatrix} = \begin{pmatrix} a_2b_3 - a_3b_2 \\ a_3b_1 - a_1b_3 \\ a_1b_2 - a_2b_1 \end{pmatrix}$$

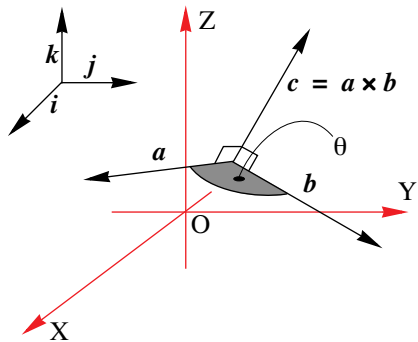

This is known as the **component form** of the cross product. The result is a third vector that is at right angles to the two original vectors. This can be verified by making use of the dot product.

Using the ‘product’ $a \cdot (a \times b)$ we have:

$$\begin{aligned} \begin{pmatrix} a_1 \\ a_2 \\ a_3 \end{pmatrix} \cdot \begin{pmatrix} a_2b_3 - a_3b_2 \\ a_3b_1 - a_1b_3 \\ a_1b_2 - a_2b_1 \end{pmatrix} &= a_1(a_2b_3 - a_3b_2) + a_2(a_3b_1 - a_1b_3) + a_3(a_1b_2 - a_2b_1) \\ &= a_1a_2b_3 - a_1a_3b_2 + a_2a_3b_1 - a_2a_1b_3 + a_3a_1b_2 - a_3a_2b_1 \\ &= 0 \end{aligned}$$

You should check for yourself that the vector product is also perpendicular to the second vector.

Also, notice that in the above diagram, the resulting vector c , points in the direction that is consistent with the right-hand rule.

EXAMPLE 27.1

Find the vector product $\begin{pmatrix} 2 \\ 4 \\ 1 \end{pmatrix} \times \begin{pmatrix} -1 \\ 4 \\ -2 \end{pmatrix}$.

$$\begin{pmatrix} 2 \\ 4 \\ 1 \end{pmatrix} \times \begin{pmatrix} -1 \\ 4 \\ -2 \end{pmatrix} = \begin{pmatrix} 4 \times -2 - 1 \times 4 \\ 1 \times -1 - (-2) \times 2 \\ 2 \times 4 - (-1) \times 4 \end{pmatrix} = \begin{pmatrix} -12 \\ 3 \\ 12 \end{pmatrix}$$

Check: $\begin{pmatrix} 2 \\ 4 \\ 1 \end{pmatrix} \cdot \begin{pmatrix} -12 \\ 3 \\ 12 \end{pmatrix} = -24 + 12 + 12 = 0$, $\begin{pmatrix} -1 \\ 4 \\ -2 \end{pmatrix} \cdot \begin{pmatrix} -12 \\ 3 \\ 12 \end{pmatrix} = 12 + 12 - 24 = 0$

2. The Determinant form

When vectors are given in base vector notation, a more convenient method of finding the **Vector Cross Product** relies on a determinant representation. Given two vectors $\mathbf{a} = a_1\mathbf{i} + a_2\mathbf{j} + a_3\mathbf{k}$ and $\mathbf{b} = b_1\mathbf{i} + b_2\mathbf{j} + b_3\mathbf{k}$, the vector product $\mathbf{a} \times \mathbf{b}$ is defined as

$$\mathbf{a} \times \mathbf{b} = \begin{vmatrix} \mathbf{i} & \mathbf{j} & \mathbf{k} \\ a_1 & a_2 & a_3 \\ b_1 & b_2 & b_3 \end{vmatrix} = \begin{vmatrix} a_2 & a_3 \\ b_2 & b_3 \end{vmatrix} \mathbf{i} - \begin{vmatrix} a_1 & a_3 \\ b_1 & b_3 \end{vmatrix} \mathbf{j} + \begin{vmatrix} a_1 & a_2 \\ b_1 & b_2 \end{vmatrix} \mathbf{k}$$

Applying this to the vectors in Example 27.1, where $\mathbf{a} = 2\mathbf{i} + 4\mathbf{j} + \mathbf{k}$ and $\mathbf{b} = -\mathbf{i} + 4\mathbf{j} - 2\mathbf{k}$ we have:

$$\begin{aligned} \mathbf{a} \times \mathbf{b} &= \begin{vmatrix} \mathbf{i} & \mathbf{j} & \mathbf{k} \\ 2 & 4 & 1 \\ -1 & 4 & -2 \end{vmatrix} = \mathbf{i} \begin{vmatrix} 4 & 1 \\ 4 & -2 \end{vmatrix} - \mathbf{j} \begin{vmatrix} 2 & 1 \\ -1 & -2 \end{vmatrix} + \mathbf{k} \begin{vmatrix} 2 & 4 \\ -1 & 4 \end{vmatrix} \\ &= -12\mathbf{i} + 3\mathbf{j} + 12\mathbf{k} \end{aligned}$$

which agrees with our previous answer.

EXAMPLE 27.2

Find $\mathbf{a} \times \mathbf{b}$ if $\mathbf{a} = 2\mathbf{i} + \mathbf{k}$ and $\mathbf{b} = 3\mathbf{i} - 4\mathbf{j} + 2\mathbf{k}$. Hence, find $|\mathbf{a} \times \mathbf{b}|$.

Using the determinant form of the cross product we have:

$$\begin{aligned} \mathbf{a} \times \mathbf{b} &= \begin{vmatrix} \mathbf{i} & \mathbf{j} & \mathbf{k} \\ 2 & 0 & 1 \\ 3 & -4 & 2 \end{vmatrix} = \mathbf{i} \begin{vmatrix} 0 & 1 \\ -4 & 2 \end{vmatrix} - \mathbf{j} \begin{vmatrix} 2 & 1 \\ 3 & 2 \end{vmatrix} + \mathbf{k} \begin{vmatrix} 2 & 0 \\ 3 & -4 \end{vmatrix} \\ &= (0 - (-4))\mathbf{i} - (4 - 3)\mathbf{j} + (-8 - 0)\mathbf{k} \\ &= 4\mathbf{i} - \mathbf{j} - 8\mathbf{k} \end{aligned}$$

Therefore, $|\mathbf{a} \times \mathbf{b}| = \sqrt{16 + 1 + 64} = \sqrt{81} = 9$

EXAMPLE 27.3

Find the angle between the vectors \mathbf{a} and \mathbf{b} if $\mathbf{a} = 2\mathbf{i} - \mathbf{j} + \mathbf{k}$ and $\mathbf{b} = 3\mathbf{i} - 4\mathbf{j} + 2\mathbf{k}$.

S
O
L
I
T
I
O
N

We first need to determine $\mathbf{a} \times \mathbf{b}$:

$$\mathbf{a} \times \mathbf{b} = \begin{vmatrix} \mathbf{i} & \mathbf{j} & \mathbf{k} \\ 2 & -1 & 1 \\ 3 & -4 & 2 \end{vmatrix} = \mathbf{i} \begin{vmatrix} -1 & 1 \\ -4 & 2 \end{vmatrix} - \mathbf{j} \begin{vmatrix} 2 & 1 \\ 3 & 2 \end{vmatrix} + \mathbf{k} \begin{vmatrix} 2 & -1 \\ 3 & -4 \end{vmatrix} = 2\mathbf{i} - \mathbf{j} - 5\mathbf{k}$$

$$\text{Next, } |\mathbf{a} \times \mathbf{b}| = \sqrt{4 + 1 + 25} = \sqrt{30}.$$

From $\mathbf{a} \times \mathbf{b} = |\mathbf{a}||\mathbf{b}|\sin\theta\hat{\mathbf{n}}$ we have that $|\mathbf{a} \times \mathbf{b}| = |\mathbf{a}||\mathbf{b}|\sin\theta$, where θ is the angle between \mathbf{a} and \mathbf{b} .

Then, as $|\mathbf{a}| = \sqrt{4 + 1 + 1} = \sqrt{6}$ and $|\mathbf{b}| = \sqrt{9 + 16 + 4} = \sqrt{29}$, we have:

$$\begin{aligned} \sqrt{30} &= \sqrt{6} \times \sqrt{29} \sin\theta \Leftrightarrow \sin\theta = \frac{\sqrt{30}}{\sqrt{6} \times \sqrt{29}} \\ \therefore \theta &\approx 24^\circ 32' \end{aligned}$$

Of course, it would have been much easier to do Example 27.3 using the scalar product!

EXAMPLE 27.4

Find a vector of magnitude 5 units perpendicular to both $\mathbf{a} = -2\mathbf{i} + \mathbf{j} + \mathbf{k}$ and $\mathbf{b} = \mathbf{i} - 3\mathbf{j} - \mathbf{k}$.

S
O
L
I
T
I
O
N

The cross product, $\mathbf{a} \times \mathbf{b}$, will provide a vector that is perpendicular to both \mathbf{a} and \mathbf{b} . In fact, it is important to realise that the vector $\mathbf{a} \times \mathbf{b}$ is perpendicular to the plane that contains the vectors \mathbf{a} and \mathbf{b} . This information will be very useful in the next sections, when the equation of a plane must be determined.

Let \mathbf{c} be the vector perpendicular to both \mathbf{a} and \mathbf{b} .

$$\begin{aligned} \text{Now, } \mathbf{c} = \mathbf{a} \times \mathbf{b} &= \begin{vmatrix} \mathbf{i} & \mathbf{j} & \mathbf{k} \\ -2 & 1 & 1 \\ 1 & -3 & -1 \end{vmatrix} = \mathbf{i} \begin{vmatrix} 1 & 1 \\ -3 & -1 \end{vmatrix} - \mathbf{j} \begin{vmatrix} -2 & 1 \\ 1 & -1 \end{vmatrix} + \mathbf{k} \begin{vmatrix} -2 & 1 \\ 1 & -3 \end{vmatrix} \\ &= (-1 + 3)\mathbf{i} - (2 - 1)\mathbf{j} + (6 - 1)\mathbf{k} \\ &= 2\mathbf{i} - \mathbf{j} + 5\mathbf{k} \end{aligned}$$

However, we want a vector of magnitude 5 units, that is, we want the vector $5\hat{\mathbf{c}}$.

$$\text{Now, } \hat{\mathbf{c}} = \frac{1}{|\mathbf{c}|} \mathbf{c} = \frac{1}{\sqrt{4 + 1 + 25}} (2\mathbf{i} - \mathbf{j} + 5\mathbf{k}) = \frac{1}{\sqrt{30}} (2\mathbf{i} - \mathbf{j} + 5\mathbf{k}).$$

$$\text{So, } 5\hat{\mathbf{c}} = \frac{5}{\sqrt{30}} (2\mathbf{i} - \mathbf{j} + 5\mathbf{k}).$$

EXAMPLE 27.5

Find a unit vector that is perpendicular to the plane containing the points $A(1, 2, 3)$, $B(2, 1, 0)$ and $C(0, 5, 1)$.

Solution

We start by drawing a diagram of the situation described so that the triangle ABC lies on the planes containing the points A , B and C .

Then, the vector, perpendicular to the plane containing the points A , B and C will be parallel to the vector produced by the cross product $\mathbf{AB} \times \mathbf{AC}$.

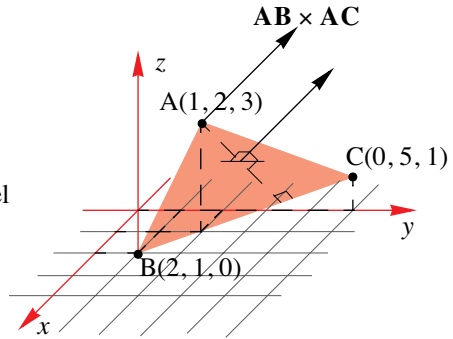

$$\text{Now, } \mathbf{AB} = \mathbf{AO} + \mathbf{OB} = -\begin{pmatrix} 1 \\ 2 \\ 3 \end{pmatrix} + \begin{pmatrix} 2 \\ 1 \\ 0 \end{pmatrix} = \begin{pmatrix} 1 \\ -1 \\ -3 \end{pmatrix}$$

$$\text{and } \mathbf{AC} = \mathbf{AO} + \mathbf{OC} = -\begin{pmatrix} 1 \\ 2 \\ 3 \end{pmatrix} + \begin{pmatrix} 0 \\ 5 \\ 1 \end{pmatrix} = \begin{pmatrix} -1 \\ 3 \\ -2 \end{pmatrix}.$$

$$\text{Then, } \mathbf{AB} \times \mathbf{AC} = \begin{pmatrix} 1 \\ -1 \\ -3 \end{pmatrix} \times \begin{pmatrix} -1 \\ 3 \\ -2 \end{pmatrix} = \begin{pmatrix} -1 \times -2 - 3 \times -3 \\ -3 \times -1 - 1 \times -2 \\ 1 \times 3 - (-1) \times -1 \end{pmatrix} = \begin{pmatrix} 11 \\ 5 \\ 2 \end{pmatrix}$$

$$\text{Let } \mathbf{c} = \mathbf{AB} \times \mathbf{AC}, \therefore \hat{\mathbf{c}} = \frac{1}{\sqrt{150}} \begin{pmatrix} 11 \\ 5 \\ 2 \end{pmatrix}.$$

EXERCISES 27.1.2

1. A set of vectors is defined by $\mathbf{a} = \begin{pmatrix} 1 \\ 2 \\ 3 \end{pmatrix}$, $\mathbf{b} = \begin{pmatrix} -1 \\ 2 \\ -3 \end{pmatrix}$, $\mathbf{c} = \begin{pmatrix} 1 \\ 0 \\ 5 \end{pmatrix}$, $\mathbf{d} = \begin{pmatrix} -2 \\ -4 \\ 3 \end{pmatrix}$

Find the vector products:

- (i) $\mathbf{a} \times \mathbf{b}$ (ii) $\mathbf{a} \times \mathbf{c}$ (iii) $\mathbf{a} \times \mathbf{d}$
 (iv) $\mathbf{b} \times \mathbf{c}$ (v) $\mathbf{b} \times \mathbf{d}$ (vi) $\mathbf{c} \times \mathbf{d}$

2. Find a vector that is perpendicular to both $\begin{pmatrix} 1 \\ 2 \\ 1 \end{pmatrix}$ and $\begin{pmatrix} 4 \\ 6 \\ -2 \end{pmatrix}$.

3. Verify that the vector $\mathbf{a} = \mathbf{i} + \mathbf{j} + \mathbf{k}$ is perpendicular to the cross product $\mathbf{a} \times \mathbf{b}$ where $\mathbf{b} = 2\mathbf{i} - 3\mathbf{j} + \mathbf{k}$.

MATHEMATICS – Higher Level (Core)

- 4.** Verify that if $\mathbf{a} = i + 6j - 3k$, $\mathbf{b} = -i + 2j + k$ and $\mathbf{c} = 2i - j - k$ then
- (a) $\mathbf{a} \times (\mathbf{b} + \mathbf{c}) = \mathbf{a} \times \mathbf{b} + \mathbf{a} \times \mathbf{c}$.
- (b) $\mathbf{a} \times (\mathbf{b} \times \mathbf{c}) = (\mathbf{a} \cdot \mathbf{c})\mathbf{b} - (\mathbf{a} \cdot \mathbf{b})\mathbf{c}$.
- 5.** If $\mathbf{a} = mi + 2j - k$ and $\mathbf{b} = 2i + nj - k$,
- (a) Find i. $\mathbf{a} \times \mathbf{a}$ ii. $\mathbf{a} \times \mathbf{b}$
- (b) Show that $mn - 4 = 0$ if $\mathbf{a} \parallel \mathbf{b}$.
- 6.** Find a vector that is perpendicular to both the vectors $i + 6j + 3k$ and $i + 2j - k$ and has a magnitude of 2.
- 7.** Find a vector that is perpendicular to the plane containing the points
- (a) $A(0, 0, 0)$, $B(0, 5, 0)$ and $C(2, 0, 0)$.
- (b) $A(2, 3, 1)$, $B(2, 6, 2)$ and $C(-1, 3, 4)$.
- 8.** Using the cross product, find, to the nearest degree, the angle between the vectors
- (a) $\mathbf{u} = 2i - j + 2k$ and $\mathbf{v} = -i + 2j + 2k$.
- (b) $\mathbf{a} = 3i - j + 2k$ and $\mathbf{b} = j + k$.
- 9.** Prove that $(\mathbf{a} + \mathbf{b}) \times (\mathbf{a} - \mathbf{b}) = 2\mathbf{b} \times \mathbf{a}$.
- 10.** Prove that $\mathbf{a} \cdot (\mathbf{a} \times \mathbf{b}) = \mathbf{b} \cdot (\mathbf{a} \times \mathbf{b}) = 0$.
- 11.** Prove that $|\mathbf{a} \times \mathbf{b}|^2 = |\mathbf{a}|^2|\mathbf{b}|^2 - (\mathbf{a} \cdot \mathbf{b})^2$.
- 12.** What condition must the vectors \mathbf{a} and \mathbf{b} satisfy in order that the vectors $\mathbf{a} + \mathbf{b}$ and $\mathbf{a} - \mathbf{b}$ are collinear?
- 13.** Prove that if $\mathbf{a} + \mathbf{b} + \mathbf{c} = \mathbf{0}$ then $\mathbf{a} \times \mathbf{b} = \mathbf{b} \times \mathbf{c} = \mathbf{c} \times \mathbf{a}$.

27.1.3 APPLICATIONS OF THE VECTOR PRODUCT

1. Area

Consider the parallelogram OACB lying on the plane, with the vectors \mathbf{a} and \mathbf{b} as shown.

Then, the area of OACB is given by

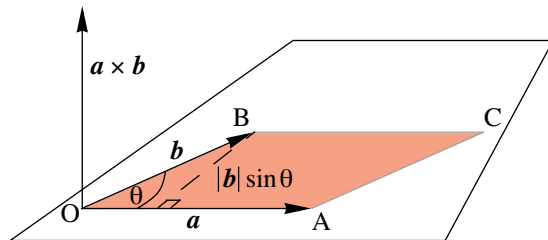
$$\begin{aligned} \text{OA} \times |\mathbf{b}| \sin \theta &= |\mathbf{a}|(|\mathbf{b}| \sin \theta) \\ &= |\mathbf{a} \times \mathbf{b}| \end{aligned}$$

i.e., the **area of the parallelogram** OACB is given by the **magnitude of** the cross product $\mathbf{a} \times \mathbf{b}$.

We can prove this by using the result $|\mathbf{a} \times \mathbf{b}|^2 = |\mathbf{a}|^2|\mathbf{b}|^2 - (\mathbf{a} \cdot \mathbf{b})^2$ (Q. 11. Exercise 27.1.2) where we replace $\mathbf{a} \cdot \mathbf{b}$ with $|\mathbf{a}||\mathbf{b}|\cos\theta$ and then carry through with some algebra. We leave this proof for the next set of exercises.

EXAMPLE 27.6

Find the area of the parallelogram determined by the vectors

$$\mathbf{a} = 2\mathbf{i} + \mathbf{j} + 3\mathbf{k} \text{ and } \mathbf{b} = \mathbf{i} + 4\mathbf{j} - \mathbf{k}.$$

S
o
l
u
t
i
o
nWe first need to determine the cross product, $\mathbf{a} \times \mathbf{b}$:

$$\begin{aligned} \mathbf{a} \times \mathbf{b} &= \begin{vmatrix} \mathbf{i} & \mathbf{j} & \mathbf{k} \\ 2 & 1 & 3 \\ 1 & 4 & -1 \end{vmatrix} = \begin{vmatrix} 1 & 3 \\ 4 & -1 \end{vmatrix} \mathbf{i} - \begin{vmatrix} 2 & 3 \\ 1 & -1 \end{vmatrix} \mathbf{j} + \begin{vmatrix} 2 & 1 \\ 1 & 4 \end{vmatrix} \mathbf{k} \\ &= -13\mathbf{i} + 5\mathbf{j} + 7\mathbf{k} \end{aligned}$$

$$\text{Now, } |\mathbf{a} \times \mathbf{b}| = |-13\mathbf{i} + 5\mathbf{j} + 7\mathbf{k}| = \sqrt{169 + 25 + 49} = \sqrt{243}$$

Then, the area of the parallelogram is given $\sqrt{243}$ unit².**EXAMPLE 27.7**

Find the area of the triangle with vertices (1, 6, 3), (0, 10, 1) & (5, 8, 3).

S
o
l
u
t
i
o
n

We construct the vectors from the vertex (1,6,3) to the vertex (0,10,1) and also the vector from (1,6,3) to (5,8,3).

$$\text{These vectors are: } \mathbf{a} = \begin{pmatrix} 0 \\ 10 \\ 1 \end{pmatrix} - \begin{pmatrix} 1 \\ 6 \\ 3 \end{pmatrix} = \begin{pmatrix} -1 \\ 4 \\ -2 \end{pmatrix} \text{ and } \mathbf{b} = \begin{pmatrix} 5 \\ 8 \\ 3 \end{pmatrix} - \begin{pmatrix} 1 \\ 6 \\ 3 \end{pmatrix} = \begin{pmatrix} 4 \\ 2 \\ 0 \end{pmatrix}.$$

$$\text{Next, we calculate the vector product: } \mathbf{a} \times \mathbf{b} = \begin{pmatrix} -1 \\ 4 \\ -2 \end{pmatrix} \times \begin{pmatrix} 4 \\ 2 \\ 0 \end{pmatrix} = \begin{pmatrix} 4 \\ -8 \\ -18 \end{pmatrix}$$

Next using the fact that $|\mathbf{a} \times \mathbf{b}| = |\mathbf{a}||\mathbf{b}|\sin\theta$ is a measure of the area of the parallelogram containing the vectors \mathbf{a} and \mathbf{b} , we can deduce the **area, A, of the triangle** containing these

$$\text{vectors to be } A = \frac{1}{2}|\mathbf{a}||\mathbf{b}|\sin\theta = \frac{1}{2}|\mathbf{a} \times \mathbf{b}|.$$

In this case, the result is

$$A = \frac{1}{2}\sqrt{4^2 + (-8)^2 + (-18)^2} = \frac{1}{2}\sqrt{404}\text{units}^2 = \sqrt{101}\text{units}^2$$

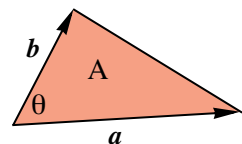
**2. Geometric proofs**

In the same way that we used the scalar product to neatly prove geometric theorems, for example, proving the cosine rule, we find that the vector product serves just as well for other geometric theorems. We now use the vector product to prove the sine rule already encountered in Chapter 9.

EXAMPLE 27.8

By making use of the vector product, derive the sine rule,

$$\frac{a}{\sin A} = \frac{b}{\sin B} = \frac{c}{\sin C}$$

S
o
l
u
t
i
o
n

Consider the triangle ABC with associated vectors as shown:

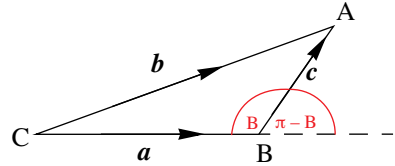

From the diagram we have that $\mathbf{a} = \mathbf{b} - \mathbf{c}$.

Then, $\mathbf{a} \times \mathbf{a} = \mathbf{a} \times (\mathbf{b} - \mathbf{c})$

But, as $\mathbf{a} \times \mathbf{a} = \mathbf{0}$,

then $\mathbf{0} = \mathbf{a} \times (\mathbf{b} - \mathbf{c})$

i.e., $\mathbf{0} = \mathbf{a} \times \mathbf{b} - \mathbf{a} \times \mathbf{c}$

$$\Rightarrow \mathbf{a} \times \mathbf{c} = \mathbf{a} \times \mathbf{b}$$

$$\Rightarrow |\mathbf{a} \times \mathbf{c}| = |\mathbf{a} \times \mathbf{b}|$$

$$\therefore |\mathbf{a}||\mathbf{c}|\sin(\pi - B) = |\mathbf{a}||\mathbf{b}|\sin C$$

$$\therefore |\mathbf{a}||\mathbf{c}|\sin B = |\mathbf{a}||\mathbf{b}|\sin C \quad [\text{As } \sin(\pi - B) = \sin B]$$

And so, $|\mathbf{c}|\sin B = |\mathbf{b}|\sin C$

$$\Leftrightarrow \frac{|\mathbf{c}|}{\sin C} = \frac{|\mathbf{b}|}{\sin B}$$

That is, $\frac{c}{\sin C} = \frac{b}{\sin B}$.

Similarly, we can prove that $\frac{|\mathbf{c}|}{\sin C} = \frac{|\mathbf{a}|}{\sin A}$, leading to the results $\frac{a}{\sin A} = \frac{c}{\sin C} = \frac{b}{\sin B}$.

EXERCISES 27.1.3

- Find the area of the parallelogram with adjacent vectors
 - $2\mathbf{i} + \mathbf{k}$ and $-\mathbf{i} - \mathbf{j} + 3\mathbf{k}$
 - $3\mathbf{i} - \mathbf{j} + 2\mathbf{k}$ and $5\mathbf{i} + \mathbf{j} - \mathbf{k}$
- A parallelogram has two adjacent sides formed by the vectors $\begin{pmatrix} 1 \\ 2 \\ 1 \end{pmatrix}$ and $\frac{1}{2}\begin{pmatrix} -14 \\ 1 \\ -1 \end{pmatrix}$.
 - Find the cross product of these two vectors.
 - Find the area of this parallelogram.
 - Hence find the angle between the two vectors.
- A triangle has vertices $(-1, 2, 4)$, $(3, 7, -5)$ and $(4, 2, 3)$. Find the area of this triangle.
- Find x , where $x > 0$, if the area of the triangle formed by the adjacent vectors $x\mathbf{i} + \mathbf{j} - \mathbf{k}$ and $\mathbf{j} - \mathbf{k}$ is 12 unit².

5. Find the area of the triangle with adjacent sides formed by the vectors $2\mathbf{i} + 3\mathbf{j} - 4\mathbf{k}$ and $2\mathbf{i} - 3\mathbf{j} + 4\mathbf{k}$. Hence find the angle enclosed by these two vectors.
6. Show that the quadrilateral with vertices at $O(4, 1, 0)$, $A(7, 6, 2)$, $B(5, 5, 4)$ and $C(2, 0, 2)$ is a parallelogram. Hence find its area.
7. Find the area of the parallelogram having diagonals $\mathbf{u} = 3\mathbf{i} - \mathbf{j} + 2\mathbf{k}$ and $\mathbf{v} = \mathbf{i} - 2\mathbf{j} + \mathbf{k}$.
8. If \mathbf{a} and \mathbf{b} are three-dimensional vectors and θ is the angle between \mathbf{a} and \mathbf{b} , use the result that $|\mathbf{a} \times \mathbf{b}|^2 = |\mathbf{a}|^2|\mathbf{b}|^2 - (\mathbf{a} \cdot \mathbf{b})^2$ to prove that $|\mathbf{a} \times \mathbf{b}| = |\mathbf{a}||\mathbf{b}|\sin\theta$.

9. (a) Find, in terms of α and β the vector expressions for

i. \mathbf{OA}

ii. \mathbf{OB}

where both \mathbf{OA} and \mathbf{OB} are unit vectors.

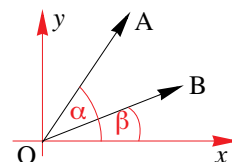

- (b) Use the vector product to prove the trigonometric identity

$$\sin(\alpha - \beta) = \sin\alpha\cos\beta - \sin\beta\cos\alpha$$

10. Let ABCD be a quadrilateral such that its diagonals, [AC] and [BD], intersect at some point O. If triangle ABC has the same area as triangle CBD, show that O is the mid-point of the diagonal [AC].
11. Show that the condition for three points A, B and C to be collinear is that their respective position vectors, \mathbf{a} , \mathbf{b} and \mathbf{c} satisfy the equation $(\mathbf{a} \times \mathbf{b}) + (\mathbf{b} \times \mathbf{c}) + (\mathbf{c} \times \mathbf{a}) = \mathbf{0}$.

12. Prove that the volume of the parallelepiped determined by the vectors \mathbf{a} , \mathbf{b} , \mathbf{c} is given by $|\mathbf{a} \cdot (\mathbf{b} \times \mathbf{c})|$.

Find the volume of the parallelepiped determined by the vectors $\mathbf{a} = 2\mathbf{i} + \mathbf{j} + 3\mathbf{k}$, $\mathbf{b} = \mathbf{i} + 4\mathbf{j} - \mathbf{k}$ and $\mathbf{c} = -2\mathbf{i} + \mathbf{j} + 5\mathbf{k}$.

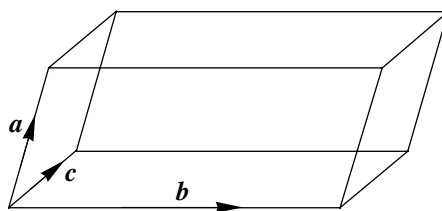

13. (a) Consider the triangle ABC where the points M, N and P lie on the sides [AB], [BC] and [CA] respectively and are such that $\mathbf{AM} = k_1\mathbf{AB}$, $\mathbf{BN} = k_2\mathbf{BC}$ and $\mathbf{CP} = k_3\mathbf{CA}$, where $k_1, k_2, k_3 \in \mathbb{R}$. Show that if the vectors \mathbf{CM} , \mathbf{AN} and \mathbf{BP} form a triangle, then, $k_1 = k_2 = k_3$.
- (b) Consider the triangle ABC where the points M, N and P lie on the sides [AB], [BC] and [CA] respectively and are such that $\mathbf{AM} = k\mathbf{AB}$, $\mathbf{BN} = k\mathbf{BC}$ and $\mathbf{CP} = k\mathbf{CA}$, and $k \in \mathbb{R}$. Find the value of k so that the area of the triangle formed by the vectors \mathbf{CM} , \mathbf{AN} and \mathbf{BP} is a minimum.

27.2 PLANES IN 3-DIMENSIONS

27.2.1 VECTOR EQUATION OF A PLANE

The approach to determine the vector equation of a plane requires only a small extension of the ideas of Chapter 26 (§26.7). In fact, apart from introducing the form that the equation of a plane has, this section has its foundations in Chapter 26 and § 27.1.

We begin with the vector equation of a plane.

Let $P(x, y, z)$, whose position vector is $\mathbf{r} = \mathbf{OP}$ be any point on the plane relative to some origin O .

Consider three points, A, B and C on this plane where $\mathbf{OA} = \mathbf{a}$, $\mathbf{AB} = \mathbf{b}$ and $\mathbf{AC} = \mathbf{c}$. That is, the plane contains the vectors \mathbf{b} and \mathbf{c} , where $\mathbf{b} \neq \mathbf{0} \neq \mathbf{c}$ and the vectors \mathbf{a}, \mathbf{b} and \mathbf{c} are non-coplanar.

Now, as \mathbf{AP}, \mathbf{b} and \mathbf{c} are coplanar, then we can express \mathbf{AP} in terms of \mathbf{b} and \mathbf{c} : $\mathbf{AP} = \lambda\mathbf{b} + \mu\mathbf{c}$ for some real λ and μ .

Then, $\mathbf{r} = \mathbf{OP} = \mathbf{OA} + \mathbf{AP} = \mathbf{a} + \lambda\mathbf{b} + \mu\mathbf{c}$.

That is, every point on the plane has a position vector of this form. As such, we say that the

vector equation of a plane is given by $\mathbf{r} = \mathbf{a} + \lambda\mathbf{b} + \mu\mathbf{c}$

This means that to find the vector form of the equation of a plane we need to know

1. the position vector of a point A in the plane, and
2. two non-parallel vectors in the plane.

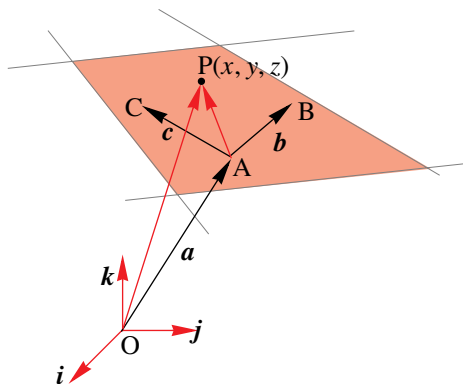

EXAMPLE 27.9

Find the vector equation of the plane containing the vectors $\begin{pmatrix} 2 \\ 1 \\ 1 \end{pmatrix}$ and $\begin{pmatrix} 3 \\ 0 \\ -1 \end{pmatrix}$

which also includes the point $(1, 2, 0)$.

S
O
L
V
E
S
T
I
O
N

Let $\mathbf{b} = \begin{pmatrix} 2 \\ 1 \\ 1 \end{pmatrix}$ and $\mathbf{c} = \begin{pmatrix} 3 \\ 0 \\ -1 \end{pmatrix}$ be two vectors on the plane. Then, as the point $(1, 2, 0)$ lies on

the plane we let $\mathbf{a} = \begin{pmatrix} 1 \\ 2 \\ 0 \end{pmatrix}$ be the position of this point. Using the vector form of the

equation of a plane, i.e., $\mathbf{r} = \mathbf{a} + \lambda\mathbf{b} + \mu\mathbf{c}$, we have $\mathbf{r} = \begin{pmatrix} 1 \\ 2 \\ 0 \end{pmatrix} + \lambda \begin{pmatrix} 2 \\ 1 \\ 1 \end{pmatrix} + \mu \begin{pmatrix} 3 \\ 0 \\ -1 \end{pmatrix}$.

27.2.2 CARTESIAN EQUATION OF A PLANE

In the same way that we were able to produce a Cartesian equation for a line in 2-D, we now derive the Cartesian equation of a plane.

Using Example 27.9 we obtain the parametric equations and use them to derive the Cartesian equation of the plane.

From the vector equation $\mathbf{r} = \begin{pmatrix} 1 \\ 2 \\ 0 \end{pmatrix} + \lambda \begin{pmatrix} 2 \\ 1 \\ 1 \end{pmatrix} + \mu \begin{pmatrix} 3 \\ 0 \\ -1 \end{pmatrix}$ we obtain the following parametric

equations:

$$\begin{aligned} x &= 1 + 2\lambda + 3\mu & - (1) \\ y &= 2 + \lambda & - (2) \\ z &= \lambda - \mu & - (3) \end{aligned}$$

Now we find expressions for λ and μ in terms of x , y and z , taking care to use all three equations while doing this:

From (1) and (3) we obtain $\lambda = \frac{x + 3z - 1}{5} - (4)$

From (2) and (3) we obtain $\mu = y - z - 2 - (5)$

Finally we substitute these back into one of the equations. In this particular case it will be easiest to use (4) and (2) - and in fact we didn't need the expression for μ , though in most cases we will.

Substituting (4) into (2) we obtain $y = 2 + \frac{x + 3z - 1}{5}$

and simplifying we get $x - 5y + 3z = -9$.

This result tells us that the

Cartesian form of a plane is given by the equation $ax + by + cz = d$

EXAMPLE 27.10

Find the Cartesian equation of the plane defined by the vector equation

$$\mathbf{r} = \begin{pmatrix} 1 \\ 3 \\ 4 \end{pmatrix} + \lambda \begin{pmatrix} -2 \\ 1 \\ 1 \end{pmatrix} + \mu \begin{pmatrix} 1 \\ 1 \\ 2 \end{pmatrix}.$$

From the vector equation of the plane, namely $\mathbf{r} = \begin{pmatrix} 1 \\ 3 \\ 4 \end{pmatrix} + \lambda \begin{pmatrix} -2 \\ 1 \\ 1 \end{pmatrix} + \mu \begin{pmatrix} 1 \\ 1 \\ 2 \end{pmatrix}$, we produce the

parametric equations:

$$\begin{aligned} x &= 1 - 2\lambda + \mu & \text{--- (1)} \\ y &= 3 + \lambda + \mu & \text{--- (2)} \\ z &= 4 + \lambda + 2\mu & \text{--- (3)} \end{aligned}$$

Next, we eliminate λ and μ :

$$\begin{aligned} (2) - (1): \quad y - x &= 2 + 3\lambda & \text{--- (4)} \\ 2 \times (2) - (3): \quad 2y - z &= 2 + \lambda & \text{--- (5)} \\ (4) - 3 \times (5): \quad -5y - x + 3z &= -4 \end{aligned}$$

That is, the Cartesian equation of the plane is given by $-5y - x + 3z = -4$ or $x + 5y - 3z = 4$.

EXERCISES 27.2.1

1. Find the vector equation of the plane containing the vectors \mathbf{b} and \mathbf{c} and passing through the point A. In each case, draw a rough diagram depicting the situation.
 - (a) $\mathbf{b} = 3\mathbf{i} + 2\mathbf{j} + \mathbf{k}$, $\mathbf{c} = -2\mathbf{i} - \mathbf{j} + \mathbf{k}$, $A \equiv (1, 0, 1)$.
 - (b) $\mathbf{b} = \mathbf{i} - \mathbf{j} + 2\mathbf{k}$, $\mathbf{c} = -\mathbf{i} - \mathbf{j} + \mathbf{k}$, $A \equiv (-1, 2, 1)$.
 - (c) $\mathbf{b} = 2\mathbf{i} + 2\mathbf{j} - \mathbf{k}$, $\mathbf{c} = 2\mathbf{i} - \mathbf{j} + 3\mathbf{k}$, $A \equiv (4, 1, 5)$.
 - (d) $\mathbf{b} = -3\mathbf{i} + \mathbf{j} - 2\mathbf{k}$, $\mathbf{c} = \mathbf{i} - 2\mathbf{j} + \frac{1}{2}\mathbf{k}$, $A \equiv (2, -3, -1)$.

2. Find the Cartesian equation for each of the planes in Question 1.

3. Find the
 - (a) vector equation
 - (b) Cartesian equation
 of the plane containing the points
 - i. $A(2, 3, 4)$, $B(-1, 2, 1)$ and $C(0, 5, 6)$
 - ii. $A(3, -1, 5)$, $B(1, 4, -6)$ and $C(2, 3, 4)$

4. A plane contains the vectors $\mathbf{b} = 2\mathbf{i} - \mathbf{j} - \mathbf{k}$ and $\mathbf{c} = 3\mathbf{i} + \mathbf{j} + 2\mathbf{k}$.
 - (a) Find the vector equation of the plane, containing the vectors \mathbf{b} and \mathbf{c} and passing through the point
 - i. $A(2, -2, 3)$.
 - ii. $A(0, 0, 0)$.
 - (b) Find the Cartesian equation for each plane in (a).
 - (c) Express $\mathbf{b} \times \mathbf{c}$ in the form $a\mathbf{i} + b\mathbf{j} + c\mathbf{k}$
 - (d) What do you notice about the coefficient of x , y and z in part (b) and the values a , b and c from part (c)?

27.2.3 NORMAL VECTOR FORM OF A PLANE

Before we formally derive the **normal vector form of a plane** we consider an example that follows directly from the work covered so far. In particular, Q. 4 from Exercise 27.2.1. – if you have not attempted this problem you should do so now, before proceeding further.

Consider a plane containing the vectors $\mathbf{b} = 3\mathbf{i} - \mathbf{j} + 2\mathbf{k}$ and $\mathbf{c} = 2\mathbf{i} + 2\mathbf{j} + \mathbf{k}$ and passing through the point $A(2, 1, 6)$. Now, the cross product $\mathbf{b} \times \mathbf{c}$ represents a vector that is perpendicular to the plane containing the vectors \mathbf{b} and \mathbf{c} .

$$\begin{aligned} \text{Let } \mathbf{n} = \mathbf{b} \times \mathbf{c} &= \begin{vmatrix} \mathbf{i} & \mathbf{j} & \mathbf{k} \\ 3 & -1 & 2 \\ 2 & 2 & 1 \end{vmatrix} = \begin{vmatrix} -1 & 2 \\ 2 & 1 \end{vmatrix} \mathbf{i} - \begin{vmatrix} 3 & 2 \\ 2 & 1 \end{vmatrix} \mathbf{j} + \begin{vmatrix} 3 & -1 \\ 2 & 2 \end{vmatrix} \mathbf{k} \\ &= -5\mathbf{i} + \mathbf{j} + 8\mathbf{k} \end{aligned}$$

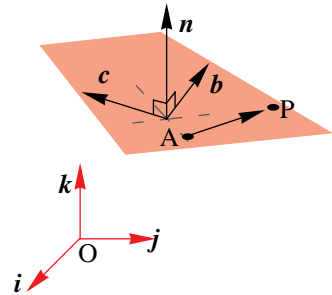

We now have a vector, $\mathbf{n} = -5\mathbf{i} + \mathbf{j} + 8\mathbf{k}$ that is perpendicular to the plane in question.

Next, consider any point $P(x, y, z)$ on this plane. As P lies on the plane the vector \mathbf{AP} must also be perpendicular to the vector \mathbf{n} . This means that $\mathbf{n} \cdot \mathbf{AP} = 0$.

To use the equation $\mathbf{n} \cdot \mathbf{AP} = 0$ we first need to find the vector \mathbf{AP} . As $\mathbf{AP} = \mathbf{AO} + \mathbf{OP}$, we have

$$\mathbf{AP} = -(2\mathbf{i} + \mathbf{j} + 6\mathbf{k}) + (x\mathbf{i} + y\mathbf{j} + z\mathbf{k}) = (x-2)\mathbf{i} + (y-1)\mathbf{j} + (z-6)\mathbf{k}$$

Then, from $\mathbf{n} \cdot \mathbf{AP} = 0$ we have

$$\begin{aligned} (-5\mathbf{i} + \mathbf{j} + 8\mathbf{k}) \cdot ((x-2)\mathbf{i} + (y-1)\mathbf{j} + (z-6)\mathbf{k}) &= 0 \\ \Leftrightarrow -5(x-2) + (y-1) + 8(z-6) &= 0 \\ \Leftrightarrow -5x + y + 8z &= 39 \end{aligned}$$

That is, we have obtained the Cartesian equation of the plane containing the vectors $\mathbf{b} = 3\mathbf{i} - \mathbf{j} + 2\mathbf{k}$ and $\mathbf{c} = 2\mathbf{i} + 2\mathbf{j} + \mathbf{k}$ and passing through the point $A(2, 1, 6)$ without making use of the parametric form of the plane.

We check this result using the parametric form of the plane.

From the vector for, $\mathbf{r} = \begin{pmatrix} 2 \\ 1 \\ 6 \end{pmatrix} + \lambda \begin{pmatrix} 3 \\ -1 \\ 2 \end{pmatrix} + \mu \begin{pmatrix} 2 \\ 2 \\ 1 \end{pmatrix}$ we obtain the parametric equations:

$$x = 2 + 3\lambda + 2\mu \quad - (1)$$

$$y = 1 - \lambda + 2\mu \quad - (2)$$

and
$$z = 6 + 2\lambda + \mu \quad - (3)$$

$$(1) - (2): \quad x - y = 1 + 4\lambda \quad - (4)$$

$$(2) - 2 \times (3): \quad y - 2z = -11 - 5\lambda \quad - (5)$$

From (4) and (5) we obtain
$$\frac{x - y - 1}{4} = \frac{y - 2z + 11}{-5} \Leftrightarrow -5x + y + 8z = 39.$$

As expected, we produce the same equation.

MATHEMATICS – Higher Level (Core)

To use this method, we require a vector that is perpendicular to the plane and a point that lies on the plane. We could use the vector, \mathbf{n} (say) or the unit vector $\hat{\mathbf{n}}$, or even $-\mathbf{n}$, as they are all perpendicular to the plane.

We can summarise this process as follows:

To find the Cartesian equation of a plane through the point $P_0(x_0, y_0, z_0)$ having a non-zero normal vector \mathbf{n} (or $\hat{\mathbf{n}}$) we

1. let $P(x, y, z)$ be any point on the plane, and
2. find the vector $\mathbf{n} = a\mathbf{i} + b\mathbf{j} + c\mathbf{k}$.

Then, as $\mathbf{P_0P} \perp \mathbf{n}$ for all points P on the plane, we have

$$\mathbf{P_0P} \cdot \mathbf{n} = 0$$

$$\Rightarrow [(x - x_0)\mathbf{i} + (y - y_0)\mathbf{j} + (z - z_0)\mathbf{k}] \cdot (a\mathbf{i} + b\mathbf{j} + c\mathbf{k}) = 0$$

$$\therefore a(x - x_0) + b(y - y_0) + c(z - z_0) = 0$$

Or, after some simplifying, $ax + by + cz = d$

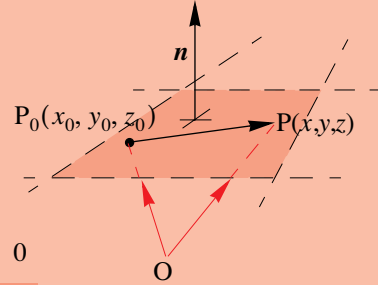

Notice that if two planes, Π_1 and Π_2 have normal vectors, $\mathbf{n}_1 = a_1\mathbf{i} + b_1\mathbf{j} + c_1\mathbf{k}$ and $\mathbf{n}_2 = a_2\mathbf{i} + b_2\mathbf{j} + c_2\mathbf{k}$ respectively, then the two planes, Π_1 and Π_2 are

1. **parallel** iff their normal vectors are parallel, i.e., iff $\mathbf{n}_1 = m \times \mathbf{n}_2$, where $m \in \mathbb{R}$

$$\text{i.e.,} \quad \text{iff} \quad \frac{a_1}{a_2} = \frac{b_1}{b_2} = \frac{c_1}{c_2} = m$$

2. **perpendicular** iff their normal vectors are perpendicular. i.e., iff $\mathbf{n}_1 \cdot \mathbf{n}_2 = 0$

$$\text{i.e.,} \quad \text{iff} \quad a_1a_2 + b_1b_2 + c_1c_2 = 0$$

Taking this one step further, this result also means that we can use the normals to find the angle between two planes.

The **angle between two planes** is defined as the **angle between their normals**.

If two planes, Π_1 and Π_2 have normal vectors

$$\mathbf{n}_1 = a_1\mathbf{i} + b_1\mathbf{j} + c_1\mathbf{k} \quad \text{and} \quad \mathbf{n}_2 = a_2\mathbf{i} + b_2\mathbf{j} + c_2\mathbf{k}$$

respectively, and intersect at an **acute angle** θ

(or $\pi - \theta$ depending on their direction), the

acute angle θ can be found from the product rule

$$\cos \theta = \frac{|\mathbf{n}_1 \cdot \mathbf{n}_2|}{|\mathbf{n}_1| |\mathbf{n}_2|}$$

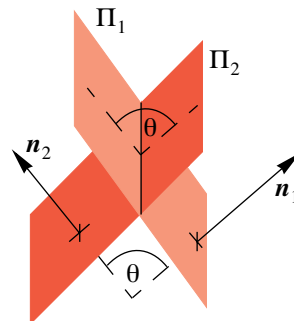

EXAMPLE 27.11

Find the Cartesian equation of the plane containing the point $A(3, 1, 1)$ and with the normal vector given by $\mathbf{n} = 3\mathbf{i} - 2\mathbf{j} + 4\mathbf{k}$.

S
o
l
u
t
i
o
n

Using the normal vector, $\mathbf{n} = 3\mathbf{i} - 2\mathbf{j} + 4\mathbf{k}$ and a vector on the plane passing through the point $A(3, 1, 1)$, i.e., the vector $\mathbf{AP} = (x - 3)\mathbf{i} + (y - 1)\mathbf{j} + (z - 1)\mathbf{k}$, where $P(x, y, z)$ is an arbitrary point on the plane, we have

$$\mathbf{n} \cdot \mathbf{AP} = 0 \Rightarrow (3\mathbf{i} - 2\mathbf{j} + 4\mathbf{k}) \cdot [(x - 3)\mathbf{i} + (y - 1)\mathbf{j} + (z - 1)\mathbf{k}] = 0$$

$$\text{That is,} \quad 3(x - 3) + (-2)(y - 1) + 4(z - 1) = 0$$

$$\text{Or, after some simplification,} \quad 3x - 2y + 4z = 11$$

EXAMPLE 27.12

Find the angle (to the nearest degree) between the planes with normal vectors $3\mathbf{i} - 2\mathbf{j} + 4\mathbf{k}$ and $\mathbf{i} - \mathbf{j} + 3\mathbf{k}$.

S
o
l
u
t
i
o
n

The angle between the planes corresponds to the angle between their normals. So, using the dot product we have

$$(3\mathbf{i} - 2\mathbf{j} + 4\mathbf{k}) \cdot (\mathbf{i} - \mathbf{j} + 3\mathbf{k}) = |3\mathbf{i} - 2\mathbf{j} + 4\mathbf{k}| |\mathbf{i} - \mathbf{j} + 3\mathbf{k}| \cos \theta$$

$$3 + 2 + 12 = \sqrt{29} \times \sqrt{11} \cos \theta$$

$$\therefore \cos \theta = \frac{17}{\sqrt{29} \times \sqrt{11}}$$

And so, we have that $\theta \approx 17^\circ 52' = 18^\circ$ (to the nearest degree).

EXAMPLE 27.13

Find the angle (to the nearest degree) between the planes $2x + 3y - 8z = 9$ and $-x + y - 2z = 1$.

S
o
l
u
t
i
o
n

To find the angle between the planes we need the normal vectors to the planes. From our observations, we have that a normal vector can be directly obtained from the equation of a plane by using the coefficients of each variable.

For the plane $2x + 3y - 8z = 9$, a normal vector would be $2\mathbf{i} + 3\mathbf{j} - 8\mathbf{k}$ and

for the plane $-x + y - 2z = 1$, a normal vector would be $-\mathbf{i} + \mathbf{j} - 2\mathbf{k}$.

Then, we proceed as in Example 27.12: using the cosine rule we have

$$(2\mathbf{i} + 3\mathbf{j} - 8\mathbf{k}) \cdot (-\mathbf{i} + \mathbf{j} - 2\mathbf{k}) = |2\mathbf{i} + 3\mathbf{j} - 8\mathbf{k}| |-\mathbf{i} + \mathbf{j} - 2\mathbf{k}| \cos \theta$$

$$\therefore -2 + 3 + 16 = \sqrt{77} \times \sqrt{6} \cos \theta$$

$$\therefore \cos \theta = \frac{17}{\sqrt{77} \times \sqrt{6}}$$

That is, $\theta \approx 37^\circ 44' = 38^\circ$ (to the nearest degree).

EXERCISES 27.2.2

1. Find the Cartesian equation of the plane containing the point P and having a normal vector, n .
 - (a) $n = 2i - j + 5k$, $P \equiv (3, 4, 1)$
 - (b) $n = -4i + 6j - 8k$, $P \equiv (-2, 3, -1)$
 - (c) $n = -i + 3j - 2k$, $P \equiv (2, 4, 5)$
 - (d) $n = 5i + 2j + k$, $P \equiv (-1, 2, 1)$

2. Which of the planes in Q.1., pass through the origin?

3. Find the Cartesian equation of the plane containing the points
 - (a) $A(2, 1, 5)$, $B(3, 2, 7)$ and $C(0, 1, 2)$
 - (b) $A(0, 2, 4)$, $B(1, 2, 3)$ and $C(4, 2, 5)$
 - (c) $A(1, 1, 7)$, $B(2, -1, 5)$ and $C(-1, 3, 7)$

4. Find the angle (to the nearest degree) between the planes with normal vectors
 - (a) $i - j + k$ and $i - j + 3k$.
 - (b) $-3i + 5j - 2k$ and $j + k$.
 - (c) $4i - 2j + 7k$ and $2i + 11j + 2k$.
 - (d) $-3i + 2j - 4k$ and $9i - 6j + 8k$.

5. Find the angle between the planes
 - (a) $\Pi_1 : -x + 3y - z = 9$ and $\Pi_2 : 6x + 2y + 3z = 4$
 - (b) $\Pi_1 : 2x + 2y - 3 = z$ and $\Pi_2 : 2y - 3z + 2 = 0$
 - (c) $\Pi_1 : 2x - y + 3z = 2$ and $\Pi_2 : 2x + y - 7z = 8$

6. Find the equation of the plane which passes through the point $A(4, 2, 1)$ and
 - (a) contains the vector joining the points $B(3, -2, 4)$ and $C(5, 0, 1)$.
 - (b) is perpendicular to the planes with equation $5x - 2y + 6z + 1 = 0$ and $2x - y - z = 4$.

7. Find the equation of the plane which passes through the point $A(-1, 2, 1)$ and is parallel to the plane $x - 2y + 3z + 2 = 0$.

8. Find the equation of the plane which passes through the point $A(-1, 2, 1)$ and is parallel to the plane $2y - 3 = 3x + 5z$.

9. The planes $4x - y + 6z = -5$ and $ax + by - z = 7$ are perpendicular. If both planes contain the point $(1, 3, -1)$ find a and b .

10.
 - (a) Find a vector equation of the line passing through the points $(3, 2, 1)$ and $(5, 7, 6)$.
 - (b) Find the normal vector of the plane $3x + 2y + z = 6$.
 - (c) Hence, find the inclination that the line $\frac{x-3}{2} = \frac{y-2}{5} = \frac{z-1}{5}$ makes with the plane $3x + 2y + z = 10$.

27.2.4 THE NORMAL FORM

We now formalise (or at least give a complete vectorial presentation for) the equation of a plane in three dimensions. The good news is that the **normal form** of the vector equation of a plane in three dimensions develops in almost the same way as the vector equation of a line in two and three dimensions.

Let \hat{n} be a (unit) vector from O normal to the plane and d be the distance of the plane from the origin.

The condition for a point P to be on the plane is that \mathbf{OA} is perpendicular to \mathbf{AP} .

That is, $\mathbf{OA} \cdot \mathbf{AP} = 0$

Now, $\mathbf{AP} = \mathbf{AO} + \mathbf{OP} = -d\hat{n} + \mathbf{r}$

So that $d\hat{n} \cdot (-d\hat{n} + \mathbf{r}) = 0$

Now, dividing by d (assumed to be non-zero)

we have $\hat{n} \cdot (-d\hat{n} + \mathbf{r}) = 0$

$$\therefore -d\hat{n} \cdot \hat{n} + \hat{n} \cdot \mathbf{r} = 0$$

$$\Rightarrow \hat{n} \cdot \mathbf{r} = d\hat{n} \cdot \hat{n}$$

$$\therefore \hat{n} \cdot \mathbf{r} = d \text{ [as } \hat{n} \cdot \hat{n} = 1 \text{]}$$

That is, the normal vector form of the equation of a plane is given by $\hat{n} \cdot \mathbf{r} = d$

If we are using \mathbf{n} (not a unit vector) the equation becomes $\mathbf{n} \cdot \mathbf{r} = D$, where D is no longer the distance of the plane from the origin.

If we know the position vector \mathbf{a} of a point on the plane we can write the equation as

$$\mathbf{r} \cdot \mathbf{n} = \mathbf{a} \cdot \mathbf{n}$$

For example $\mathbf{r} \cdot \begin{pmatrix} 1 \\ 1 \\ 1 \end{pmatrix} = 8$ is the equation of a plane. We can get this into a Cartesian form by

noting that \mathbf{r} is the position vector of some arbitrary point P(x,y,z) on the plane and so we can

write the vector expression as $\begin{pmatrix} x \\ y \\ z \end{pmatrix} \cdot \begin{pmatrix} 1 \\ 1 \\ 1 \end{pmatrix} = 8$, or $x + y + z = 8$.

Converting from Cartesian to vector form: $2x - y + 4z = 2$ becomes $\mathbf{r} \cdot \begin{pmatrix} 2 \\ -1 \\ 4 \end{pmatrix} = 2$.

If we want to get the equation in \hat{n} form, i.e., in the form $\hat{n} \cdot \mathbf{r} = d$ we can work out that the

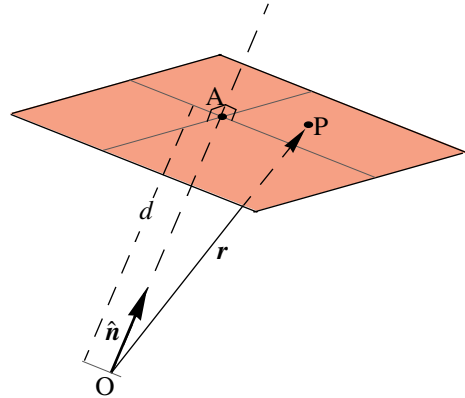

length of the vector $\begin{pmatrix} 2 \\ -1 \\ 4 \end{pmatrix}$ is $\sqrt{2^2 + (-1)^2 + 4^2} = \sqrt{21}$, and so, from the equation $\mathbf{r} \cdot \begin{pmatrix} 2 \\ -1 \\ 4 \end{pmatrix} = 2$

we divide both sides by $\sqrt{21}$ to get $\frac{1}{\sqrt{21}}\mathbf{r} \cdot \begin{pmatrix} 2 \\ -1 \\ 4 \end{pmatrix} = \frac{1}{\sqrt{21}} \times 2$ or $\mathbf{r} \cdot \frac{1}{\sqrt{21}}\begin{pmatrix} 2 \\ -1 \\ 4 \end{pmatrix} = \frac{2}{\sqrt{21}}$.

We then get the information that the distance of the plane from the origin is $\frac{2}{\sqrt{21}}$.

EXAMPLE 27.14

Show that the line $\mathbf{r} = \begin{pmatrix} 2 \\ 1 \\ 0 \end{pmatrix} + k \begin{pmatrix} 4 \\ 3 \\ 1 \end{pmatrix}$ is parallel to the plane $x - 2y + 2z = 11$.

S
o
l
u
t
i
o
n

We need to prove that \mathbf{n} is perpendicular to \mathbf{v} .
Rewriting $x - 2y + 2z = 11$ in the normal vector

form, we have $\mathbf{r} \cdot \begin{pmatrix} 1 \\ -2 \\ 2 \end{pmatrix} = 11$.

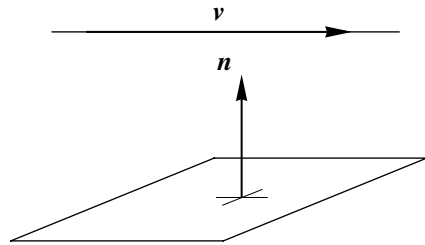

From this equation a suitable \mathbf{n} is the vector $\begin{pmatrix} 1 \\ -2 \\ 2 \end{pmatrix}$.

From the vector equation of the line, the direction vector of \mathbf{v} is $\begin{pmatrix} 4 \\ 3 \\ 1 \end{pmatrix}$.

As $\begin{pmatrix} 1 \\ -2 \\ 2 \end{pmatrix} \cdot \begin{pmatrix} 4 \\ 3 \\ 1 \end{pmatrix} = 4 - 6 + 2 = 0$, the vectors are perpendicular. So the line and plane are parallel.

EXAMPLE 27.15

Show that the line $\mathbf{r} = \begin{pmatrix} 2 \\ 1 \\ 0 \end{pmatrix} + s \begin{pmatrix} 5 \\ 1 \\ -1 \end{pmatrix}$ lies in the plane $x - 3y + 2z = -1$.

S
o
l
u
t
i
o
n

From the vector equation of the line we obtain the parametric equations

$$x = 2 + 5s$$

$$y = 1 + s$$

and $z = -s$

If this line lies on the plane, then the parametric equations must satisfy the Cartesian

equation of the plane. Substituting, into the equation $x - 3y + 2z = -1$, we get

$$\begin{aligned} \text{L.H.S} &= x - 3y + 2z = (2 + 5s) - 3(1 + s) - 2s \\ &= 2 + 5s - 3 - 3s - 2s \\ &= -1 \\ &= \text{R.H.S} \end{aligned}$$

Therefore, the line lies in the plane.

EXERCISES 27.2.3

For this set of exercises, where appropriate, make use of the normal vector form to solve the questions.

1. Convert these planes to Cartesian and vector form:

$$(a) \quad \mathbf{r} = \begin{pmatrix} 1 \\ 1 \\ -4 \end{pmatrix} + \lambda \begin{pmatrix} 2 \\ 2 \\ 3 \end{pmatrix} + \mu \begin{pmatrix} -3 \\ 0 \\ -1 \end{pmatrix} \quad (b) \quad \mathbf{r} = \begin{pmatrix} 2 \\ 1 \\ 1 \end{pmatrix} + \lambda \begin{pmatrix} 2 \\ 1 \\ 0 \end{pmatrix} + \mu \begin{pmatrix} 0 \\ 0 \\ 1 \end{pmatrix}$$

2. Given $A(1, 1, 0)$, $B(2, 1, 3)$ and $C(1, 2, -1)$, find the Cartesian equation of the plane containing A , B and C . (Find a parametric form first by taking A as the point in the plane and \mathbf{AB} and \mathbf{AC} as the two vectors in the plane.)

3. Re-solve question 2 by taking the Cartesian form as $x + by + cz = d$, then calculating b , c and d (simultaneous equations in three unknowns).

4. Show that the line $x + 1 = \frac{y+2}{3} = \frac{4-z}{4}$ and the plane $5x + y + 2z = 20$ are parallel.

5. Find the distance of each of these planes from the origin (i.e. find d):

(a) $2x - 3y + 6z = 21$

(b) $2x - y + 2z = 5$

(c) $x + y - 3z = 11$

(d) $4x + 2y - z = 20$

6. Find the equation of the plane through $(1, 2, 3)$ parallel to $3x + 4y - 5z = 0$.

7. Find the equation of the plane through the three points $(1, 1, 0)$, $(1, 2, 1)$ and $(-2, 2, -1)$.

8. Show that the four points $(0, -1, 0)$, $(2, 1, 1)$, $(1, 1, 1)$ and $(3, 3, 2)$ are coplanar.

9. Find the equation of the plane through $(2, -3, 1)$ normal to the line joining $(3, 4, -1)$ and $(2, -1, 5)$.

27.3 INTERSECTING LINES & PLANES

27.3.1 INTERSECTION OF TWO LINES

This topic was dealt with in detail in Chapter 26 (§26.7.3), however, we review it here to maintain a logical flow to the topic.

In general two lines (in 3 dimensions) will not intersect, but in certain circumstances they may.

We can show, for example, that the lines $\mathbf{r} = \begin{pmatrix} -1 \\ 4 \\ 0 \end{pmatrix} + \lambda \begin{pmatrix} 3 \\ -2 \\ 1 \end{pmatrix}$ and $\mathbf{r} = \begin{pmatrix} 4 \\ 4 \\ -1 \end{pmatrix} + \mu \begin{pmatrix} 2 \\ -3 \\ 2 \end{pmatrix}$

do intersect, and we can find the point of intersection.

We show that there exist values of λ and μ which make the x -, y - and z - coordinates of the two lines identical. If we compare the x - and y -coordinates we get

$$\begin{aligned} -1 + 3\lambda &= 4 + 2\mu \\ 4 - 2\lambda &= 4 - 3\mu \end{aligned}$$

We can solve these to get $\lambda = 3$ and $\mu = 2$. The point that will decide whether the two lines intersect is:

when $\lambda = 3$ and $\mu = 2$, are the z -coordinates also equal?

This can be tested: $\lambda = 3$ and $\mu = 2$, l has z -coordinate $= 0 + \lambda = 3$ and m has z -coordinate $= -1 + 2\mu = 3$. So the lines do intersect.

Substituting $\lambda = 3$ and $\mu = 2$ in the expressions for the x - and y -coordinates we find that the point of intersection is $(8, -2, 3)$. If the z -coordinates had been different, we would deduce that the lines do not intersect.

One point of terminology: recall that lines which do not intersect and are not parallel (a situation we looked at in §26.7.3) are said to be *skew*.

EXERCISES 27.3.1

- Show that the lines $\mathbf{r}_A = 5\mathbf{i} + \mathbf{j} + \mathbf{k} + \lambda(\mathbf{i} + 2\mathbf{j} - 2\mathbf{k})$ and $\mathbf{r}_B = 11\mathbf{i} + 4\mathbf{j} - 2\mathbf{k} + \mu(4\mathbf{i} - \mathbf{j} + \mathbf{k})$ intersect, and find their point of intersection.
 - By considering the scalar product $(\mathbf{i} + 2\mathbf{j} - 2\mathbf{k}) \cdot (4\mathbf{i} - \mathbf{j} + \mathbf{k})$, show that the lines from part (a) intersect at right angles.

- Given the lines: (a) $\mathbf{r} = \begin{pmatrix} 5 \\ 2 \\ 3 \end{pmatrix} + \kappa \begin{pmatrix} -1 \\ 3 \\ 5 \end{pmatrix}$ (b) $\mathbf{r} = \begin{pmatrix} 1 \\ 2 \\ 1 \end{pmatrix} + \lambda \begin{pmatrix} 2 \\ -2 \\ 3 \end{pmatrix}$ (c) $\mathbf{r} = \begin{pmatrix} 5 \\ -6 \\ 2 \end{pmatrix} + \mu \begin{pmatrix} 1 \\ 1 \\ 4 \end{pmatrix}$

find the two lines that intersect. Find also the coordinates of the point of intersection, and the acute angle between the two lines.

3. Show that the line joining $(1, 4, 3)$ to $(7, -5, -6)$ intersects the line $\frac{x-1}{2} = -y = \frac{z-3}{3}$, and find the point of intersection. (Find a parametric form for each line – remember to use a different parameter for each line.)

4. Show that the three lines:

$$L: x = y + 4 = \frac{z}{2} + 1 \quad M: \frac{x-1}{3} = 2y + 1 = z - 5 \quad N: \frac{x}{4} = y + 1 = \frac{z-3}{3}$$

intersect at a single point, and give its coordinates.

27.3.2 INTERSECTION OF A LINE AND A PLANE

If you have not attempted question 10., in Exercise 27.2.2, do so now before proceeding with this section.

In § 27.2.3 we considered the case of a line and a plane being parallel, and the case of a line lying in a plane. If neither of these happens then the line and plane must intersect in a point.

The angle between a line and a plane is defined as the angle between the line and its **projection** on the plane.

To find the angle between a line and a plane we look at the vectors \mathbf{n} (perpendicular to the plane) and \mathbf{v} (in the direction of the line):

We can find angle ϕ from the formula $\cos \phi = \frac{\mathbf{v} \cdot \mathbf{n}}{|\mathbf{v}| |\mathbf{n}|}$

then subtract from 90° to find θ .

Alternatively we can use the fact that $\cos \phi = \sin \theta$

to write directly $\sin \theta = \frac{\mathbf{v} \cdot \mathbf{n}}{|\mathbf{v}| |\mathbf{n}|}$.

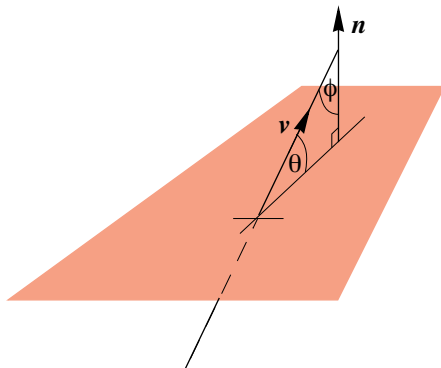

EXAMPLE 27.16

Find the point of intersection of the line $\frac{x}{2} = \frac{y+6}{2} = 3z-1$ and the plane $3x + y - z = 9$. Find also the angle between the line and the plane.

Solution

Introducing a parameter λ , we have the parametric equations $x = 2\lambda$, $y = 2\lambda - 6$ and $z = \frac{\lambda + 1}{3}$. Substituting each of these values into the equation of the plane

$$3x + y - z = 9 \text{ we obtain: } 6\lambda + (2\lambda - 6) - \frac{\lambda + 1}{3} = 9$$

$$\text{i.e., } 18\lambda + 6\lambda - 18 - (\lambda + 1) = 27$$

$$\therefore \lambda = 2$$

Substituting $\lambda = 2$, we get $x = 4$, $y = -2$ and $z = 1$, i.e. the point of intersection is $(4, -2, 1)$.

Writing the equation of the plane as $\mathbf{r} \cdot \begin{pmatrix} 3 \\ 1 \\ -1 \end{pmatrix} = 9$ and the equation of the line as

$$\mathbf{r} = \begin{pmatrix} 0 \\ -6 \\ \frac{1}{3} \end{pmatrix} + \lambda \begin{pmatrix} 2 \\ 2 \\ \frac{1}{3} \end{pmatrix}, \text{ we have that } \mathbf{n} = \begin{pmatrix} 3 \\ 1 \\ -1 \end{pmatrix} \text{ and } \mathbf{v} = \begin{pmatrix} 2 \\ 2 \\ \frac{1}{3} \end{pmatrix}.$$

$$\text{Then } \mathbf{v} \cdot \mathbf{n} = 6 + 2 - \frac{1}{3} = 7\frac{2}{3}, |\mathbf{v}| = \sqrt{8\frac{1}{9}} \text{ and } |\mathbf{n}| = \sqrt{11}.$$

Hence $\cos\phi = 0.81165\dots$, $\phi = 35.7^\circ$ and finally $\theta = 54.3^\circ$.

EXERCISES 27.3.2

1. In each case find (i) the point of intersection of the line and plane, and (ii) the angle between the line and plane:

line

plane

(a) $\mathbf{i} + 2\mathbf{j} + \lambda(3\mathbf{i} + \mathbf{j} + \mathbf{k})$

$\mathbf{r} \cdot (2\mathbf{i} + 4\mathbf{j} - \mathbf{k}) = 28$

(b) $\frac{x-1}{2} = y = \frac{3-z}{4}$

$2x + 3y + z = 11$

(c) $\begin{pmatrix} 3 \\ 4 \\ 2 \end{pmatrix} + \kappa \begin{pmatrix} -1 \\ 3 \\ 3 \end{pmatrix}$

$\begin{pmatrix} 4 \\ 1 \\ 0 \end{pmatrix} + \lambda \begin{pmatrix} 0 \\ 1 \\ 1 \end{pmatrix} + \mu \begin{pmatrix} -2 \\ 1 \\ 2 \end{pmatrix}$

(d) $\frac{x-1}{2} = \frac{y-2}{-3} = \frac{z+3}{4}$

$2x + 4y - z - 1 = 0$

2. (a) A line joins the origin to (6, 10, 8). Find the coordinates of the point where the line cuts the plane $2x + 2y + z = 10$.
- (b) Find the point where the line joining (2, 1, 3) to (4, -2, 5) cuts the plane $2x + y - z = 3$.
3. Try to describe with words and/or diagrams:
- (a) the plane $x + y = 6$
- (b) the line $x = 4, y = 2z$.

Now find their point of intersection.

4. Find the distance of the point (-1, -5, -10) from the point of intersection of the line $\frac{x-2}{3} = \frac{y+1}{4} = \frac{z-2}{12}$ and the plane $x - y + z = 5$.

27.3.3 INTERSECTION OF TWO PLANES

A full treatment of solving simultaneous equations in three unknowns is provided in Chapter 2, §2.3.3. We revisit this area using the development of 3-D geometry that has evolved over this chapter and Chapter 26. You will also find in Chapter 25 a different method for solving simultaneous equation than that used here or in §2.3.3. Both the matrix method and the method of row reduction are used in Chapter 25.

If two planes are parallel they will clearly not intersect (unless they coincide), and this case will be identifiable because their respective \mathbf{n} vectors will be parallel. For example the planes $2x - y - z = 3$ and $-4x + 2y + 2z = 7$ are parallel because their respective \mathbf{n} vectors are $2\mathbf{i} - \mathbf{j} - \mathbf{k}$ and $-4\mathbf{i} + 2\mathbf{j} + 2\mathbf{k}$, and $-4\mathbf{i} + 2\mathbf{j} + 2\mathbf{k} = -2(2\mathbf{i} - \mathbf{j} - \mathbf{k})$. If two planes are not parallel they must intersect in a line.

EXAMPLE 27.17

Find the equation of the line of intersection of the planes:

$$x + 3y + z = 5 \quad (1)$$

$$2x - y - z = 1 \quad (2)$$

Find also the angle between the two planes.

S
o
l
u
t
i
o
n

Our strategy is to eliminate z and hence write x in terms of y .

Adding (1) and (2): $3x + 2y = 6$ and so $x = \frac{6 - 2y}{3}$

Now we eliminate y and write x in terms of z .

Adding (1) to $3 \times (2)$: $7x - 2z = 8$ and so $x = \frac{2z + 8}{7}$

Putting these together into a single equation we have the line $x = \frac{6 - 2y}{3} = \frac{2z + 8}{7}$.

Note: having found the line it is worth choosing a simple-valued point on the line, such as $(2, 0, 3)$, and checking that it lies on both planes - which in this case it does.

To find the angle between the planes we find the angle between their normal vectors.

Rewriting the equations as $\mathbf{r} \cdot (\mathbf{i} + 3\mathbf{j} + \mathbf{k}) = 5$ and $\mathbf{r} \cdot (2\mathbf{i} - \mathbf{j} - \mathbf{k}) = 1$ we can calculate:

$$(\mathbf{i} + 3\mathbf{j} + \mathbf{k}) \cdot (2\mathbf{i} - \mathbf{j} - \mathbf{k}) = -2 \quad |(\mathbf{i} + 3\mathbf{j} + \mathbf{k})| = \sqrt{11} \quad |(2\mathbf{i} - \mathbf{j} - \mathbf{k})| = \sqrt{6}$$

Hence $\cos \theta = \frac{-2}{\sqrt{66}}$ and $\theta = 104.3^\circ$.

If the acute angle was required it would be $(180^\circ - 104.3^\circ) = 75.7^\circ$.

EXERCISES 27.3.3

1. Where possible, find a Cartesian equation of the line of intersection of the two planes and find the acute angle between them:

(a) $x + y + z = 3$ and $2x + y + 3z = 0$

(b) $2x + y + 4z = 7$ and $-x + 3y + z = -8$

(c) $\mathbf{r} = \begin{pmatrix} 4 \\ 2 \\ 1 \end{pmatrix} + p \begin{pmatrix} 1 \\ 2 \\ 0 \end{pmatrix} + q \begin{pmatrix} -1 \\ 1 \\ 3 \end{pmatrix}$ and $\mathbf{r} = \begin{pmatrix} 0 \\ 2 \\ 0 \end{pmatrix} + \lambda \begin{pmatrix} 1 \\ 5 \\ 3 \end{pmatrix} + \mu \begin{pmatrix} 2 \\ 1 \\ -3 \end{pmatrix}$

(d) $\mathbf{r} \cdot (3\mathbf{i} + 2\mathbf{j} + \mathbf{k}) = 10$ and $\mathbf{r} \cdot (\mathbf{i} - 4\mathbf{j} - 2\mathbf{k}) = 8$.

2. (a) Show that the point $(5, 2, -1)$ lies on the line of intersection of the planes $x - 3y + z = -2$ and $2x + y + 3z = 9$.

(b) Show that the line of intersection of the planes $x + y + z = 2$ and $2x - y + 3z = -4$ is perpendicular to $x = y = z$.

(c) Show that the equation of the line of intersection of the planes $4x + 4y - 5z = 12$ and $8x + 12y - 13z = 32$ can be written as $\frac{x-1}{2} = \frac{y-2}{3} = \frac{z}{4}$.

3. Find the angle between the lines defined by the intersection of the planes

$$\begin{cases} x - 2y + z = 0 \\ x + y - z = 0 \end{cases} \text{ and } \begin{cases} x + 2y + z = 0 \\ 8x + 12y + 5z = 0 \end{cases}$$

27.3.4 INTERSECTION OF THREE PLANES

Case (i)

When we write the equations of three planes such as :

$$x + y + 2z = 0 \tag{1}$$

$$2x - y + z = -6 \tag{2}$$

$$3x + 4y - z = -6 \tag{3}$$

and consider their possible intersection, we are solving a system of equations in three unknowns, as already covered in Chapters 2 and 25. There are three possible outcomes:

- (i) a single solution
- (ii) no solution
- (iii) an infinity of solutions.

Before reading on it is worth playing with three planes (books, pieces of card) and trying to get a

clear picture of the geometrical interpretation of each of these possibilities.

$$\text{If } M \text{ is the underlying } 3 \times 3 \text{ matrix of the system, in our case } \begin{bmatrix} 1 & 1 & 2 \\ 2 & -1 & 1 \\ 3 & 4 & -1 \end{bmatrix} \begin{bmatrix} x \\ y \\ z \end{bmatrix} = \begin{bmatrix} 0 \\ -6 \\ -6 \end{bmatrix},$$

$\det M \neq 0$ leads to outcome (i) and $\det M = 0$ leads either to (ii) or to (iii).

Here $\det M = 1(-1 \times -1 - 4 \times 1) - 1(2 \times -1 - 3 \times 1) + 2(2 \times 4 - 3 \times -1) = 24$, which means a unique solution - i.e. a single point of intersection.

To find this point we could eliminate z from (1) and (3), then from (2) and (3):

$$(1) + 2(3) \quad 7x + 9y = -12$$

$$(2) + (3) \quad 5x + 3y = -12$$

and then solve. We get $x = -3$ and $y = 1$, and by going back to (1) we find $z = 1$. Hence the point of intersection is $(-3, 1, 1)$.

(There is considerable freedom as to which variable to eliminate and how to set about eliminating it.)

Case (ii)

Now we look at a case where $\det M = 0$ but there is no solution - i.e. the planes have no common point. Such a system is:

$$3x + y + 4z = 8 \quad (1)$$

$$3x - y - z = 4 \quad (2)$$

$$x + y + 3z = 2 \quad (3)$$

We set off in the same way as in Case (i): by eliminating one of the variables in two different ways. For this system the obvious variable to eliminate is y :

$$(1) + (2) \quad 6x + 3z = 12$$

$$(2) + (3) \quad 4x + 2z = 6$$

The first equation is equivalent to $2x + z = 4$ and the second is equivalent to $2x + z = 3$. The equations are inconsistent with each other and there is no solution to the system. The three dimensional picture is of three planes that have no point of intersection.

Case (iii)

In this system check that $\det M = 0$:

$$3x - y - z = 1 \quad (1)$$

$$x + 2y + z = 4 \quad (2)$$

$$x - 5y - 3z = -7 \quad (3)$$

We could eliminate x in two ways:

$$3 \times (2) - (1) \quad 7y + 4z = 11$$

$$(2) - (3) \quad 7y + 4z = 11.$$

It is important to be clear what this means: if we choose *any* y and z satisfying $7y + 4z = 11$ we can find the value of x such that all three equations (1, 2 and 3) are satisfied. An example would be $y = z = 1$, leading to $x = 1$; check that all three equations are satisfied. But if we chose to

MATHEMATICS – Higher Level (Core)

satisfy $7y + 4z = 11$ with $y = 5, z = -6$ we get $x = 0$, and again all three equations are satisfied. Clearly we could find as many solutions as we wanted. Solution is $\left(\frac{\lambda + 6}{7}, \frac{11 - 4\lambda}{7}, \lambda\right)$.

To summarise: if $\det M = 0$ there are two possibilities.

- When we eliminate one of the variables in two different ways and we get two inconsistent equations in the other two variables, then we have no solution. The three dimensional picture of this is three planes that fail to intersect.
- When we eliminate one of the variables in two different ways and we get two identical equations in the other two variables, then we have an infinity of solutions. The three dimensional picture of this is three planes intersecting in a line. (To find the equation of the line, find the equation of the line of intersection of any two of the planes.)

EXERCISES 27.3.4

- Three planes can fail to have any point of intersection if two or more of them are parallel. Describe a situation where three planes fail to intersect but no pair of planes is parallel.
- Analyse Case (ii) in a little more detail:
 - Find a Cartesian equation of the line of intersection of $3x + y + 4z = 8$ and $3x - y - z = 4$.
 - Show that this line is parallel to $x + y + 3z = 2$.
- Analyse Case (iii) in a little more detail:
 - Find a Cartesian equation of the line of intersection of $3x - y - z = 1$ – (1) and $x + 2y + z = 4$ – (2).
 - Show that this line lies in the plane $x - 5y - 3z = -7$ – (3).
 - Show that (1) = $2 \times$ (2) + (3).
- Classify each set of planes as (i) intersecting in a single point, in which case give its coordinates, or (ii) no point of intersection, or (iii) intersecting in a line, in which case give a Cartesian equation.

	$x + y - z = 10$		$x + y + z = 10$
(a)	$2x - 3y + z = 5$	(b)	$2x - y = 9$
	$x - 4y + 2z = 6$		$-x + 3y + 4z = 14$
	$x + 2y - z = 10$		$2x + y + 3z = -5$
(c)	$3x - y + z = 11$	(d)	$x - 2y + 2z = -9$
	$2x + y + 4z = -1$		$3x + 4y + 4z = -1$

5. This question involves concepts from the whole of this chapter.

OBCDEFGH is a cuboid with $O(0, 0, 0)$; $B(0, 0, 3)$; $C(4, 0, 3)$; $D(4, 0, 0)$; $E(4, 2, 0)$; $F(0, 2, 0)$; $G(0, 2, 3)$; $H(4, 2, 3)$.

- Sketch the cuboid.
- Find parametric forms for the equations of lines OH and BE. Show that the two lines intersect at the point $(2, 1, 1.5)$.
- Find the Cartesian equation of plane FHD. (A parametric form is $\mathbf{r} = \mathbf{OF} + s\mathbf{FH} + t\mathbf{FD}$. Now convert to Cartesian form.)
- Find the coordinates of the point of intersection of line BE and plane FHD, and also the angle between the line and plane.
- Find the angle between plane FHD and plane GHCB.

$$x + y - z = -1$$

6. Show that the equations $5x + 3y + z = 3$ are inconsistent for $a = 1$ and describe this situation geometrically in terms of intersecting planes.

$$2x + y + z = a$$

7. Find the value of k for which the system of equations

$$8x + 3y + z = 12$$

$$x + 2z = 3$$

$$2x + y - z = k$$

represents 3 planes that intersect in a common line and find the vector equation in parametric form of the line of intersection.

8. The planes $x - 3y - z = 0$ and $3x - 5y - z = 0$ intersect in a line, L, that passes through the origin.

- Find the vector product of the normals to both planes.
- Hence, find the vector equation of L.

$$x - 3y - z = 0$$

- (c) Find the value of k for which the system of equations $3x - 5y - z = 0$ has

$$-x + ky + 2z = k^2 - 4$$

- no real solutions.
- infinitely many solutions.
- a unique solution.

9. (a) On a set of axes, sketch the planes $x + y = 2a$, $y + z = 2b$, $z + x = 2c$.
 (b) Find where the planes meet. i.e., solve the system of equations

$$x + y = 2a$$

$$y + z = 2b$$

$$z + x = 2c$$

- (c) Hence, deduce the solution to the system $x + y = \frac{2}{a}$, $y + z = \frac{2}{b}$, $z + x = \frac{2}{c}$

MATHEMATICS – Higher Level (Core)

- 10.** (a) Find the two values of k for which the planes with equations
 $-x + y + 2z = 3$, $kx + y - z = 3k$ and $x + 3y + kz = 13$
 have no unique solution.
 (b) Show that for one value of k , there are in fact no solutions.
 (c) Show that for the other value of k , the planes meet along a line. Find the Cartesian equation of this line.

- 11.** Show that the equation for the plane passing through the point $M(x_0, y_0, z_0)$ and perpendicular to the planes $a_1x + b_1y + c_1z = d_1$ and $a_2x + b_2y + c_2z = d_2$ can be

written in the form
$$\begin{vmatrix} x - x_0 & y - y_0 & z - z_0 \\ a_1 & b_1 & c_1 \\ a_2 & b_2 & c_2 \end{vmatrix} = 0$$

- 12.** Show that the equation for the plane passing through the points $M(x_0, y_0, z_0)$, $N(x_1, y_1, z_1)$ and perpendicular to the plane $ax + by + cz = d$ can be written in the

form
$$\begin{vmatrix} x - x_0 & y - y_0 & z - z_0 \\ x_1 - x_0 & y_1 - y_0 & z_1 - z_0 \\ a & b & c \end{vmatrix} = 0.$$

- 13.** Show that the equation for the plane passing through the point $M(x_0, y_0, z_0)$ and parallel

to the straight lines $L_1: \mathbf{r} = \begin{pmatrix} a_1 \\ b_1 \\ c_1 \end{pmatrix} + \lambda \begin{pmatrix} l_1 \\ m_1 \\ n_1 \end{pmatrix}$ and $L_2: \mathbf{r} = \begin{pmatrix} a_2 \\ b_2 \\ c_2 \end{pmatrix} + t \begin{pmatrix} l_2 \\ m_2 \\ n_2 \end{pmatrix}$

may be written in the form
$$\begin{vmatrix} x - x_0 & y - y_0 & z - z_0 \\ l_1 & m_1 & n_1 \\ l_2 & m_2 & n_2 \end{vmatrix} = 0.$$

- 14.** Show that the equation for the plane which contains the lines

$$L_1: \mathbf{r} = \begin{pmatrix} a_1 \\ b_1 \\ c_1 \end{pmatrix} + \lambda \begin{pmatrix} l \\ m \\ n \end{pmatrix} \quad \text{and} \quad L_2: \mathbf{r} = \begin{pmatrix} a_2 \\ b_2 \\ c_2 \end{pmatrix} + t \begin{pmatrix} l \\ m \\ n \end{pmatrix}$$

may be written in the form
$$\begin{vmatrix} x - a_1 & y - b_1 & z - c_1 \\ a_2 - a_1 & b_2 - b_1 & c_2 - c_1 \\ l & m & n \end{vmatrix} = 0.$$

REVISION SET E - PAPER 1 & PAPER 2 STYLE QUESTIONS

- 1.** (a) Evaluate i. $\int_1^4 \left(x + \frac{1}{\sqrt{x}}\right)^2 dx$ ii. $\int_0^1 x\sqrt{x+1} dx$
- (b) Find i. $\int \frac{2x}{\sqrt{1-x^2}} dx$ ii. $\int \frac{4}{9+16x^2} dx$ iii. $\int \frac{1}{\sqrt{1-4x^2}} dx$
- 2.** (a) Find the general solution of the differential equation $\frac{dN}{dt} = N - 2, N > 2$.
- (b) The velocity of an object, $v \text{ ms}^{-1}$, at time $t \text{ sec}$ is given by $v = \sin(2t), t \geq 0$.
Find the distance travelled, in metres, in the first $\frac{3\pi}{2}$ seconds.
- (c) If $y' = y^2 + 1$ and $y = 1$ when $t = \frac{\pi}{2}$, find an expression for y in terms of t .
- 3.** An object is moving in a horizontal line so that the acceleration $a \text{ ms}^{-2}$ at time $t \text{ sec}, t \geq 0$ is given by $a = \frac{1}{2v-4}$ where v is the velocity of the object. If the initial velocity of the object is 1 ms^{-1} , find the expression for the velocity at time t seconds.
- 4.** (a) If $\vec{OA} = 3\mathbf{i} - 2\mathbf{j} + \mathbf{k}$ and $\vec{OB} = \mathbf{i} + 2\mathbf{k}$, find $2\vec{OB} + 3\vec{AO}$.
- (b) The angle between the vectors $\mathbf{u} = 2\mathbf{i} - \mathbf{j} + 3\mathbf{k}$ and $\mathbf{v} = \mathbf{i} + 4\mathbf{j} - 2\mathbf{k}$ is θ .
Find a given that $\cos \theta = \frac{a}{\sqrt{14 \times 21}}$.
- (c) Find a unit vector perpendicular to $2\mathbf{i} + \mathbf{j} - 3\mathbf{k}$.
- 5.** Consider the following continuous random variables
- $$f(x) = \begin{cases} \frac{1}{2}x^2, & 0 \leq x \leq \sqrt[3]{6} \\ 0, & \text{otherwise} \end{cases}, f(z) = \begin{cases} \sin z, & 0 \leq z \leq \frac{\pi}{2} \\ 0, & \text{otherwise} \end{cases}, f(u) = \begin{cases} k - 2u, & 0 \leq u \leq 1 \\ 0, & \text{otherwise} \end{cases}$$
- (a) Find $P\left(X < \frac{1}{2}\right)$ (b) Find the median of Z . (c) Find k .
- 6.** (a) Show that $\frac{1}{x^2+1} = \frac{1}{2}x$ when $x = 1$.
- (b) The region bounded by the y -axis and the curves with equations $y = \frac{1}{2}x$ and $y = \frac{1}{x^2+1}$ is rotated about the y -axis to form a solid of revolution.
- i. Write down an expression, in the form of a definite integral for the volume of the solid.
- ii. Calculate, to 2 d.p. the volume of the solid.

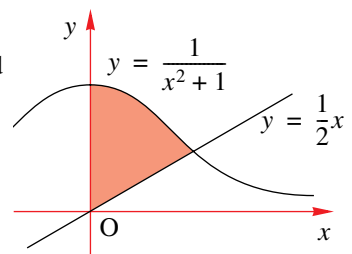

MATHEMATICS – Higher Level (Core)

- 7.** The speed, $v \text{ ms}^{-1}$, of a particle moving in a straight line at time t seconds is given by $v = \sqrt{9 - x^2}$, where $x \text{ m}$ is the position of the particle relative to a fixed origin, O. Find, correct to the nearest cm, the distance travelled by the particle in the first 2 seconds of its motion if it starts at the origin.
- 8.** A salt solution has initially a volume of 100 litres. Pure water is poured into the solution at 10 litres per minute and the mixture, kept well stirred, is removed at the rate of 7 litres per minute. Find, but **do not solve**, the differential equation for the mass, $m \text{ kg}$, of salt present at time t minutes.
- 9.** (a) Find the equation of a plane that is perpendicular to the vector $4\mathbf{i} - \mathbf{j} - 4\mathbf{k}$ and contains the point A(1, 2, 1).
(b) Find the equation of the plane which contains the points $(-2, 3, 1)$, $(1, -2, 3)$ and $(3, 1, 2)$.
(c) Find the point of intersection of the line $\frac{x-1}{3} = \frac{y+2}{4} = \frac{z+3}{2}$ and the plane $2x + y - z = 27$.
- 10.** (a) Find the values of x between 0 and 2π for which $\sin x = \sqrt{3} \cos x$.
(b) Sketch, on the same set of axes, the graphs of $y = \sin x$ and $y = \sqrt{3} \cos x$ for values of x from 0 to 2π . Hence find $\{x \mid \sin x > \sqrt{3} \cos x, 0 \leq x \leq 2\pi\}$.
(c) Find the area enclosed between the two curves in (b).
- 11.** During a trench-digging operation, which takes 2 hours, the rate at which earth is being removed, after t minutes, is $(12 - 0.1t)$ cubic metres per minute, for $0 \leq t \leq 120$. Find the total volume of earth removed.
- 12.** (a) Find, in i. parametric form ii. Cartesian form the line of intersection of the planes $3x + 2y - z = 6$ and $x + 4y - z = -1$.
(b) Find the point of intersection of the plane
i. $3x + 5y - z + 2 = 0$ and the line $\frac{x+3}{2} = y-4 = \frac{z+1}{-3}$.
ii. $4x + 5y + 6z = 87$ and the line $x = 2 + 3t, y = 3 + 4t, z = -4 + 2t$.
(c) Find the equation of the plane containing the point $(1, -1, 5)$ and perpendicular to the line $x = 1 + 2\lambda, y = -3 + 5\lambda, z = -2 - \lambda$.
- 13.** Find a and b if the planes $2x - by + 2z + 4 = 0$ and $ax - 3y + z = 5$ are parallel.
- 14.** Find the cosine of the acute angle between the lines $x = -1 + 2\lambda, y = 1 + 3\lambda, z = 2 - \lambda$ and $x = 7 + 5\mu, y = -8 - 3\mu, z = -2 + \mu$.
- 15.** (a) Find $\mathbf{a} \times \mathbf{b}$ if $\mathbf{a} = 2\mathbf{i} - \mathbf{j} + 3\mathbf{k}$ and $\mathbf{b} = 3\mathbf{i} + 3\mathbf{j} - \mathbf{k}$.
(b) $5\mathbf{i} - 2\mathbf{j} + 4\mathbf{k}$ and $\mathbf{i} + a\mathbf{j} + b\mathbf{k}$ are parallel vectors, find a and b .
(c) The diagonals of a parallelogram are given by the vectors $3\mathbf{i} + \mathbf{j} - 2\mathbf{k}$ and $\mathbf{i} - 3\mathbf{j} + 4\mathbf{k}$. Find the area of the parallelogram.

- 16.** A horizontal water trough, 0.9 metres long, has a parabolic vertical section, represented by the parabola $y = \frac{25}{4}x^2$ from $x = -0.2$ to $x = 0.2$.

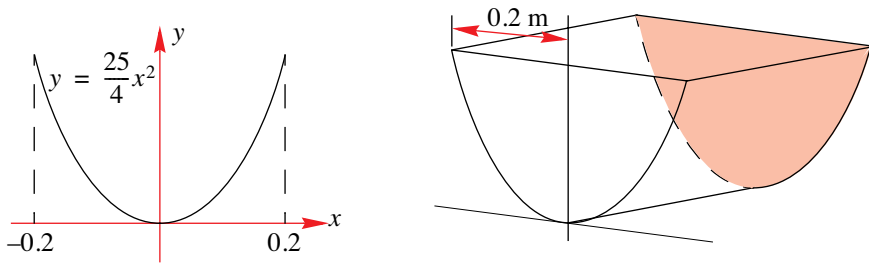

All measurements are in metres.

Water is flowing into the trough at the rate of 0.01 cubic metres / minute. At time t minutes, the depth of water in the trough is h metres and the volume of water in the trough is V cubic metres.

- (a) Find, in terms of h , the area enclosed between the parabola $y = \frac{25}{4}x^2$ and the line $y = h$. Hence find V in terms of h .
- (b) Given that $\frac{dV}{dt} = \frac{dV}{dh} \times \frac{dh}{dt}$, find the rate at which the water level in the trough is rising, when the depth is 0.16 metres.
- 17.** Let $f(x) = 1 - \frac{3}{x^2}$, $x \neq 0$ and $g(x) = x^2 - 3x$.
- (a) Find the coordinates of the points of intersection of the graphs of f and g .
- (b) Sketch on the same set of axes the graphs of f and g .
- (c) Find the area of the region enclosed between these two graphs.
- 18.** (a) Evaluate $\int_0^{\frac{\pi}{2}} \left(\sin \frac{x}{2} + \cos 2x \right) dx$.
- (b) Differentiate $\log_e(x^2 + 2)$. Hence evaluate $\int_0^2 \frac{2x}{x^2 + 2} dx$.
- 19.** The graph of the function $f(x) = xe^{-x/2}$ is shown in the following diagram.

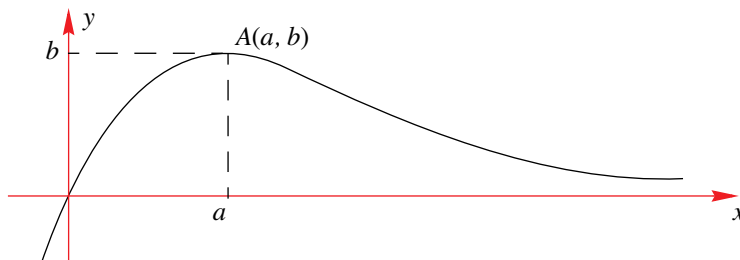

- (a) Find the coordinates of the turning point, A, and justify that it is a maximum by considering the sign of the first derivative.
- (b) i. Find the equation of the tangent at the origin O.
- ii. Find $\frac{d}{dx}(xe^{-x/k})$ and hence show that $\int_0^a xe^{-x/2} dx = 4 - 2(2+a)e^{-a/2}$.

MATHEMATICS – Higher Level (Core)

- iii. Find the area of the region enclosed by the curve $y = xe^{-x/2}$, the tangent to the curve $y = xe^{-x/2}$ at the origin and the straight line $x = a$.
- (c) i. Show that $\frac{d}{dx}(x^2e^{-x}) = 2xe^{-x} - x^2e^{-x}$.
- ii. Using the results of (b) and (c) i., find the volume of the solid generated by revolving the curve with equation $y = xe^{-x/2}$ about the x -axis from $x = 0$ to $x = 2$.

20. (a) If $f'(x) = 2x\sqrt{2x-1}$, find $f(x)$.

(b) i. Evaluate $\int_0^{\pi/6} \sin^2 6x dx$ and hence evaluate $\int_0^{\pi/6} \sin^2 3x \cos^2 3x dx$.

ii. Evaluate $\int_0^{\pi/6} \sin^2 3x \cos 3x dx$

(c) i. Sketch the graph of $f : \{x | -2 < x < 2\} \mapsto \mathbb{R}$ where $f(x) = \frac{1}{\sqrt{4-x^2}}$.

ii. Find the area of the region bounded by the graph, the x -axis and the lines $x = -1$ and $x = 1$.

iii. Find the volume when the region above is rotated about the x -axis.

21. If $A = \begin{bmatrix} 2 & -1 \\ -1 & 2 \end{bmatrix}$, $X = \begin{bmatrix} x \\ y \end{bmatrix}$ where $x, y \neq 0$ and $AX = kX$ where k is a constant, find the values of k for which the equation is true.

22. The position vector of two particles, A and B is given by $\mathbf{r}_A = at\mathbf{i} + (bt - 5t^2)\mathbf{j} + t^2\mathbf{k}$ and $\mathbf{r}_B = 8t\mathbf{i} - 4t\mathbf{j} + 4t\mathbf{k}$. If the two particles collide at a point in space find when and where they collide and the values of a and b .

23. Consider the three planes whose equations are $x + y + z = 0$, $kx + y - 2z = -6$, and $2y + (k + 2)z = k - 2$

- (a) i. Find the point(s) of intersection of the three planes, giving your answer in terms of k .
- ii. Give the values of k for which there is only 1 solution.
- (b) Find a value of k for which there are no solutions.
- (c) i. Find a value of k for which the planes intersect along a line.
- ii. Give the parametric equation of this line.

24. Find A^2 if $A = \begin{bmatrix} 0 & 2 & 1 \\ 1 & 1 & 1 \\ -1 & -2 & -2 \end{bmatrix}$. **Hence** solve the system equations $\begin{cases} x + 2y + 2z = 1 \\ 2y + z = -2 \\ x + y + z = 0 \end{cases}$

25. The matrices A, B and X are such that $A^{-1} = \frac{1}{2}A$, $B^{-1} = \frac{1}{9}B$ and $ABX = I$, where I is the unit matrix, find BX, X and AX in terms of A and B .

- 26.** The graph of the function $y = e^{2x} - 4x$ is shown in the following diagram.

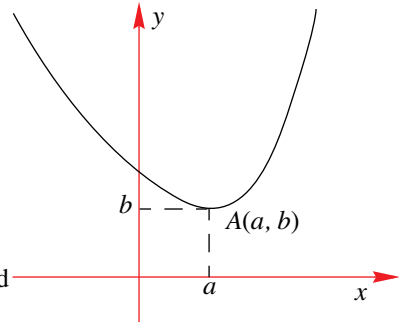

- (a) Find the coordinates of the turning point, A, and justify that it is a minimum by considering the sign of the first derivative.
- (b) Find the area of the region enclosed by the curve $y = e^{2x} - 4x$, the coordinates axes and the line $x = 1$.
- (c) i. Given that $\frac{d}{dx}(xe^{2x}) = e^{2x} + 2xe^{2x}$, show that $\int_0^1 8xe^{2x} dx = 2e^2 + 2$.
- ii. Find the volume of the solid of revolution formed when the region enclosed by the curve with equation $y = e^{2x} - 4x$ and the lines $x = 0$ and $x = 1$ is rotated about the x -axis.

- 27.** Consider the function $g: \mathbb{R}^+ \rightarrow \mathbb{R}$, where $g(x) = 2(1 - x) + \log_e x$.

- (a) Show that the graph of $y = g(x)$ has an intercept at $x = 1$.
- (b) Find $g'(x)$ and specify the values of x for which $g'(x)$ is
i. positive ii. zero iii. negative.
- (c) Find the coordinates of any stationary point of the graph of $y = g(x)$.
- (d) Sketch the graph of $y = g(x)$, but do not make any attempt to determine any x -intercept other than $x = 1$.
- (e) i. Find the equation of the tangent at the point where $x = 1$.
ii. Find the equation of the normal at the point where $x = 1$.
- (f) i. Given that $\int (\log_e x) dx = x \log_e(x) - x + c$, find the area of the region enclosed by the curve $y = g(x)$, the tangent to the curve at $x = 1$ and the line $x = 0.5$.
ii. **Hence** find the area of the region enclosed by the curve $y = g(x)$, the normal to the curve at $x = 1$ and the line $x = 0.5$.

- 28.** Determine the constants A and B so that $x = t(A \cos 2t + B \sin 2t)$ will satisfy the equation $\frac{d^2x}{dt^2} + 4x = 2 \cos 2t$ for all values of t .

- 29.** (a) Find the area of the region enclosed by the curve with equation $y = 7x^2(1 - x)$ and the x -axis.
(b) The region enclosed between the curve with equation $y = 7x^2(1 - x)$ and the x -axis is rotated about the x -axis to form a solid of revolution. Find the volume of this solid.

- 30.** Let $f: \{x | x \geq a\} \rightarrow \mathbb{R}$, where $f(x) = (x - 2)^2$.

- (a) If a has the least real value for which the inverse function, f^{-1} exists, find a and define f^{-1} .
(b) Find the volume of the solid of revolution formed by rotating about the x -axis the curve $y = f^{-1}(x)$ between $x = 0$ and $x = 4$.

MATHEMATICS – Higher Level (Core)

- 31.** (a) Find the equation of the normal to the curve $y = e^{x-2}$ at the point where $x = 1$.
 (b) Show the curve and the normal on a sketch graph.
 (c) Find the area of the region enclosed by the normal, the curve and the y -axis.
- 32.** (a) Find the area of the region enclosed by $y = x^2 + 1$ and $y = 2$
 (b) If the region in (a) is now rotated about the x -axis. Find the volume of the solid of revolution generated.
- 33.** The concentration, x grams per litre, of salt in a solution at any time t minutes is given by $\frac{dx}{dt} = \frac{20 - 3x}{30}$.
 (a) If the initial concentration was 2 grams per litre, solve the differential equation, giving x in terms of t .
 (b) Find the time taken, to the nearest minute, for the salt concentration to rise to 6 grams per litre.
- 34.** Find the derivative of $\sqrt{x}\tan^{-1}\sqrt{x}$. Hence evaluate $\int_1^3 \frac{\tan^{-1}\sqrt{x}}{\sqrt{x}} dx$.
- 35.** Sand is poured at a constant rate of V cubic metres per minute into an inverted conical tank which has its base radius the same length as its height. Sand comes out of the hole at the bottom of the tank at a rate of $k\sqrt{h}$ cubic metres per minute, where h metres is the height of the sand in the tank and v cubic metres is its volume at any time t minutes.
 (a) Set up, but do not solve, the differential equations for v and h .
 (b) Find the minimum height of the tank, in terms of V and k , if sand is not to eventually pour out of the top of the tank.
- 36.** Let the position vectors of points A and B be $\vec{OA} = -2\mathbf{i} - \mathbf{j} + \mathbf{k}$ and $\vec{OB} = \mathbf{i} - 2\mathbf{j} - \mathbf{k}$.
 Find (a) \vec{AB} .
 (b) the angle AOB to the nearest degree.
 (c) the position vector of a point C if B is the mid-point of AC.
- 37.** Let $A = \begin{bmatrix} 1 & 2i \\ -2i & 1 \end{bmatrix}$ where $i^2 = -1$. (a) Show that $A^2 = 2A + 3I$.
 (b) Find A^{-1} in terms of A and I .
- 38.** (a) Differentiate $\sqrt{1-x^2}\sin^{-1}x$. Hence evaluate $\int_0^{\frac{\sqrt{3}}{2}} \frac{x\sin^{-1}x}{\sqrt{1-x^2}} dx$.
 (b) Find an antiderivative of i. $x\sqrt{1-x}$. ii. $\frac{e^{2x}}{e^x + 1}$.
 (c) Evaluate $\int_0^1 \frac{x^2}{x^3 + 1} dx$.
- 39.** The region enclosed by the curve $y = x^2 + 1$ and the line $y = 2$ is rotated about the x -axis. Find the volume of the solid of revolution.

- 40.** The position vectors of particles A, B and C from a fixed point O, at any time t , are given by $\mathbf{r}_A = 2t^2\mathbf{i} + (t + 1)\mathbf{j}$, $\mathbf{r}_B = 2t\mathbf{i} + (2t - 4)\mathbf{j}$ and $\mathbf{r}_C = bt^3\mathbf{i} + (bt + 4)\mathbf{j}$ where b is a constant.
- (a) Find the minimum distance from O to the path of particle B.
 (b) If particles A and C collide, find when they collide and the value of b .
- 41.** A vat contains 100 litres of water. A sugar solution with a concentration of 0.5 kg of sugar per litre is pumped into the vat at 10 litres per minute. The solution is thoroughly mixed in the vat and solution is drawn off at 10 litres per minute.
- (a) If there is x kg of sugar in solution at any time t minutes, set up, but do not solve, the differential equation for x .
 (b) A mistake is made in preparing the solution to be pumped into the vat. After using this solution, the concentration of sugar in the vat after 10 minutes is 0.2 kg per litre. Find, correct to 2 decimal places, the concentration of the sugar solution being pumped into the vat.

- 42.** If $\begin{bmatrix} a & 2 \\ 1 & 1 \end{bmatrix} \begin{bmatrix} x \\ y \end{bmatrix} = \begin{bmatrix} 1 \\ 2 \end{bmatrix}$, where $a \in \mathbb{R}$
- (a) find $\begin{bmatrix} x \\ y \end{bmatrix}$ as a matrix in terms of a .
 (b) state when $\begin{bmatrix} x \\ y \end{bmatrix}$ is not defined.
 (c) find x and y if $a = 3$.

- 43.** The force on a bridge (in newtons) is a continuous random variable X with probability

$$\text{density function given by } f(x) = \begin{cases} \frac{1}{8}(a + 3x), & 0 \leq x \leq 2 \\ 0 & \text{otherwise} \end{cases}. \text{ Find}$$

- (a) a (b) $E(X)$ (c) $\text{Var}(X)$ (d) $P(1 < X < 1.5)$
- 44.** (a) The triangle ABC is such that $\mathbf{AB} = 3\mathbf{i} + 6\mathbf{j} - 2\mathbf{k}$ and $\mathbf{AC} = 4\mathbf{i} - \mathbf{j} + 3\mathbf{k}$.
 Find i. $\angle BAC$ ii. the area of $\triangle ABC$
- (b) PQRS is a trapezium with $\overrightarrow{PQ} = \mathbf{p}$, $\overrightarrow{PS} = \mathbf{s}$ and $\overrightarrow{SR} = 3\mathbf{p}$. T is the midpoint of [QR]. Express the following in terms of \mathbf{p} and \mathbf{s} .
 i. \overrightarrow{PR} ii. \overrightarrow{QR} iii. \overrightarrow{PT} iv. \overrightarrow{ST}
- 45.** (a) Given that $M = \begin{bmatrix} \cos\theta & -\sin\theta \\ \sin\theta & \cos\theta \end{bmatrix}$, find $\det(M)$.
 (b) If $A = \begin{bmatrix} 2 & a \\ 0 & 1 \end{bmatrix}$, prove by induction that for $n \geq 1$, $A^n = \begin{bmatrix} 2^n & (2^n - 1)a \\ 0 & 1 \end{bmatrix}$.
 (c) Find the value of a such that the matrix $M = \begin{bmatrix} 3 & 2 & 1 \\ 0 & 1 & 3 \\ -1 & a & 1 \end{bmatrix}$ is singular.

MATHEMATICS – Higher Level (Core)

- 46.** The position vectors of the points A, B and C are $i - j + 2k$, $2i + j + 4k$ and $3i + 4k$ respectively. Find
- the angle BAC to the nearest degree.
 - the area of the triangle ABC.
- 47.** (a) Find the i. vector ii. parametric and iii. Cartesian equation of the line through the point with position vector $\begin{pmatrix} 2 \\ -3 \end{pmatrix}$ & parallel to $\begin{pmatrix} 3 \\ 7 \end{pmatrix}$.
- (b) Find the position vector of the point of intersection of the lines
- $$l_1 : \mathbf{r} = \begin{pmatrix} 14 \\ -1 \end{pmatrix} + \lambda \begin{pmatrix} 5 \\ -4 \end{pmatrix} \text{ and } l_2 : \mathbf{r} = \begin{pmatrix} 9 \\ -4 \end{pmatrix} + \mu \begin{pmatrix} -4 \\ 6 \end{pmatrix}$$
- (c) i. Are the straight lines $x - 1 = \frac{y}{3} = \frac{z - 1}{4}$ and $\frac{x - 2}{4} = 3 - y = z$ parallel?
- ii. Find the point(s) of intersection of the lines in i. What do you conclude?
- 48.** (a) i. Find the Cartesian equation of the plane defined by the vector equation $\mathbf{r} \cdot (2\mathbf{i} + 3\mathbf{j} - 4\mathbf{k}) = 2$
- ii. Find the angle that the plane in i., makes with the plane defined by the vector equation $\mathbf{r} \cdot (\mathbf{i} - 2\mathbf{j} - \mathbf{k}) = 1$
- (b) Find the acute angle between the
- lines $\mathbf{r} = \begin{pmatrix} 1 \\ 2 \\ 4 \end{pmatrix} + \lambda \begin{pmatrix} 4 \\ 3 \\ 1 \end{pmatrix}$ and $\mathbf{r} = \begin{pmatrix} -1 \\ -4 \\ 1 \end{pmatrix} + \mu \begin{pmatrix} 3 \\ 2 \\ 3 \end{pmatrix}$.
 - line $\mathbf{r} = \begin{pmatrix} 2 \\ -1 \\ -4 \end{pmatrix} + \lambda \begin{pmatrix} 3 \\ 4 \\ -2 \end{pmatrix}$ and the plane $\mathbf{r} \cdot \begin{pmatrix} 1 \\ 1 \\ 1 \end{pmatrix} = -4$.
- 49.** Find the point of intersection of the planes $\mathbf{r} \cdot \begin{pmatrix} 1 \\ 1 \\ -1 \end{pmatrix} = 9$, $\mathbf{r} \cdot \begin{pmatrix} 3 \\ 4 \\ 3 \end{pmatrix} = 2$ and $\mathbf{r} \cdot \begin{pmatrix} 4 \\ 5 \\ 3 \end{pmatrix} = 5$.
- 50.** The position vectors of the points A, B and C are given by $\overrightarrow{OA} = \mathbf{i} + 2\mathbf{j} + 2\mathbf{k}$, $\overrightarrow{OB} = \mathbf{i} + a\mathbf{j} - 2\mathbf{k}$ and $\overrightarrow{OC} = b\mathbf{i} + 3\mathbf{j} + c\mathbf{k}$ where a, b and c are constants. Find
- a if \overrightarrow{OA} is perpendicular to \overrightarrow{OB} .
 - b and c if O, A and C are collinear.
- 51.** Find the equation of the line of intersection of the planes $4x + y - 3z = 1$ and $x - y + 4z = 2$. Giving your answer in vector form.
- 52.** (a) Find a unit vector perpendicular to both $2\mathbf{i} + \mathbf{j} + \mathbf{k}$ and $3\mathbf{j} - 2\mathbf{k}$.
- (b) Find the equation of a plane containing the point $(3, 1, -1)$ and perpendicular to the line joining the points $(1, 2, 1)$ and $(-1, 1, -2)$.

53. Let $A = \begin{bmatrix} -2 & -3 & -1 \\ 1 & 2 & 1 \\ 3 & 3 & 2 \end{bmatrix}$. Find all real numbers k such that the matrix $A - kI$ has no inverse.

54. Let $A = \begin{bmatrix} 1 & 1 & -1 \\ 3 & 4 & 6 \end{bmatrix}$, $B = \begin{bmatrix} 2 & 0 \\ -2 & 1 \end{bmatrix}$, $C = \begin{bmatrix} 1 \\ 7 \end{bmatrix}$ and $X = \begin{bmatrix} x \\ y \\ z \end{bmatrix}$.

- (a) Evaluate i. BC ii. B^{-1}
 (b) Find the equations of the planes produced from the matrix equation $AX = C$.
 (c) Give the vector equation of the straight line where the two planes in (b) meet.

55. (a) Evaluate i. $\int_{\frac{\pi}{3}}^{\frac{2\pi}{3}} x \sin x dx$ ii. $\int_0^{\pi} x \cos \frac{x}{2} dx$

- (b) The curve with equation $y = 2 \cos x$ is rotated about the x -axis to form a surface of revolution. Find the volume of the solid enclosed by this surface between $x = 0$ and $x = \frac{\pi}{4}$.
 (c) P is the point where $x = 1$ on the curve whose equation is $y = 1 + \ln(x)$.
 i. Find the equation of the normal to the curve at P.
 ii. Find the area of the region enclosed by the normal, the curve and the coordinate axes.

- 56.** (a) Sketch the curve whose equation is $y = \arctan x$.
 (b) Find the area enclosed between this curve, the line $x = \sqrt{3}$ and the x -axis.

- 57.** (a) Show that $\frac{1}{x} + \frac{1}{2-x} = \frac{2}{x(2-x)}$
 (b) Find the real numbers a and b such that

i. $\int_{\frac{1}{2}}^1 \frac{1}{2x-x^2} dx = \log_e a$.

ii. $\int_{\frac{1}{2}}^1 \frac{1}{\sqrt{2x-x^2}} dx = \pi b$.

- 58.** The region bounded by the coordinate axes, the curve whose equation is $y = 1 + \log_e x$ and the line $y = 1 + \log_e c$ (where c is a constant greater than 1) is rotated about the y -axis to form a solid of revolution. Find the volume of this solid.

59. (a) Sketch the region $\left\{ (x, y) : \frac{x^2}{4} + (y-1)^2 \leq 1 \right\} \cap \left\{ (x, y) : y \geq 1 \right\}$.

- (b) The region defined in part (a) is rotated about the x -axis to form a bead-shaped solid of revolution, with a cylindrical hole through its centre. Find the volume of this solid.

MATHEMATICS – Higher Level (Core)

- 60.** OABC, DEFG is a cuboid with $\vec{OA} = xi$, $x > 0$, $\vec{OC} = 3j$ and $\vec{OD} = 4k$.
- Find x if the angle between the diagonals given by \vec{OF} and \vec{AG} is a right angle.
 - Also find x if the same diagonals are 60° to each other.
- 61.** Water is poured into an inverted cone of height 10 cm and base radius 5 cm at a rate of $Q \text{ cm}^3\text{s}^{-1}$. It pours out of a hole at the vertex at a rate given by $k\sqrt{h} \text{ cm}^3\text{s}^{-1}$ where k is a positive constant and h cm is the height of the cone at any time t seconds.
- Show that $\frac{dh}{dt} = \frac{4}{\pi h^2}(Q - k\sqrt{h})$.
 - When the height is 9 cm, the inflow of water is stopped. Find the time, to the nearest second, for the water to flow out of the cone if $k = 1$.
- 62.** The intensity of light, I units, at a given depth, x cm, in a liquid solution is given by $\frac{dI}{dx} = -kI$. For a given light source, the intensity is measured as I_1 units at x_1 cm and I_2 units at $3x_1$ cm. Find the intensity at the surface in terms of I_1 , I_2 and x_1 .
- 63.** (a) Consider the planes $\alpha : ax - 2y + z = 1$ and $\beta : 3x + by + z = 0$.
Find the values of a and b if
- $\alpha \parallel \beta$.
 - $\alpha \perp \beta$.
- (b) Find the point of intersection of the line $r = \begin{pmatrix} 3 \\ 0.5 \\ 1 \end{pmatrix} + \lambda \begin{pmatrix} 5 \\ 3.5 \\ 1 \end{pmatrix}$ and the plane $2x - 5y + 3z = 20$.
- (c) i. Find the area of the triangle with vertices at $(0,0,0)$, $(2, 2, 1)$ and $(-2, 9, 5)$.
ii. Find the equation of the plane containing the triangle in (a).
iii. Find the equation of the straight line through $(0,0,0)$ and perpendicular to the plane in (b). Give your answer in vector form.
- 64.** (a) Find i. $\int x \arctan x dx$ ii. $\int \arcsin x dx$.
- (b) Find i. $\int_0^a x^2 \sin 2x dx$, $a > 0$ ii. $\int_1^e x^2 (\ln x)^2 dx$.
- 65.** Two particles P and Q move along the same straight-line path, and can overtake one another. Their velocities are $V_P = 2 - t + 0.25t^2$ and $V_Q = 0.75 + 0.5t$ respectively at time t , for $t \geq 0$.
- Find the times when the velocities of P and Q are the same.
 - On the same set of axes, sketch the velocity-time graphs of P and Q.
 - Given that P and Q started from the same point at time $t = 0$, find the time when P and Q meet again.
- 66.** Newton's Law of cooling states that the rate of cooling of a body is proportional to the excess of its temperature above that of its surroundings.
A body at a temperature of 70°C is placed in a room whose temperature is maintained at 20°C . If, after 10 min, the temperature of the body is 55°C , find the temperature after a further 15 min.

EXERCISE 2.1

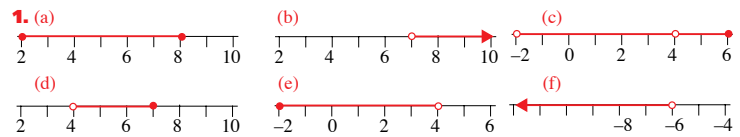

2. (a) $[-2, 7]$ (b) $]9, \infty[$ (c) $]0, 5]$ (d) $]-\infty, 0]$ (e) $]-4, 8[$ (f) $]-\infty, -1[\cup]2, \infty[$ 3. (a) $5\sqrt{3}$ (b) $-\sqrt{3}$
 (c) $\sqrt{3}$ 4. (a) 4 (b) $4 + \sqrt{6}$ (c) $6\sqrt{2}$ (d) $31 + 12\sqrt{3}$ 5. (a) $2 - \sqrt{3}$ (b) $\sqrt{7} + 2$ (c) $2\sqrt{3} + \sqrt{15}$
 (d) $-2 - \sqrt{3} - 4\sqrt{5} - 2\sqrt{15}$ (e) $\frac{3 + \sqrt{6} + \sqrt{10} + \sqrt{15}}{-2}$ (f) $3\sqrt{6} + 2\sqrt{15}$ 6. (a) i. $\frac{3\sqrt{5} + \sqrt{3}}{2}$

- ii. $10 + \frac{3\sqrt{15}}{2}$ (b) i. $\frac{14\sqrt{3} + 48}{13}$ ii. $\frac{1344\sqrt{3} + 3230}{169}$ 7. (a) $\{\pm 3\}$ (b) $\{\pm 10\}$ (c) \emptyset
 (d) $\{-4, 2\}$ (e) $\{-12, 8\}$ (f) $\{0, 4\}$

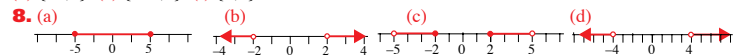

9. (a) $]1, \infty[$ (b) $]4, \infty[$ (c) $]4, 6[$ 11. (a) $\sqrt{6} + \sqrt{3}$ (b) $2\sqrt{2} - 2$

EXERCISE 2.2.1

1. (a) 4 (b) 3 (c) -6 (d) $-\frac{11}{2}$ (e) $\frac{1}{10}$ (f) $\frac{3}{8}$ 2. (a) $\frac{17}{5}$ (b) $\frac{4}{3}$ (c) $-\frac{3}{4}$ (d) $\frac{4}{3}$ (e) $\frac{35}{2}$ (f) $\frac{92}{41}$
 3. (a) $-\frac{44}{5}$ (b) -39 (c) $-\frac{1}{7}$ (d) -3 (e) 2 (f) 4 4. (a) $2b - 2$ (b) $b + 1 + \frac{b}{a}$ (c) $\frac{ab}{a+b}$
 (d) $a(a+b)$ (e) ab (f) $\frac{ab}{a-b}$ (g) 0 (h) $\frac{a+b}{a^2+b^2}$ (i) $a+b$ 5. (a) -4, 4 (b) $-\frac{9}{5}, 3$ (c) -6, 18
 (d) $-\frac{11}{2}, \frac{17}{2}$ (e) $-\frac{7}{10}, \frac{1}{10}$ (f) $-\frac{5}{8}, \frac{3}{8}$ (g) $-\frac{7}{5}, \frac{17}{5}$ (h) $\frac{4}{3}, \frac{20}{3}$ (i) -3, 0 (j) $\frac{a-b}{2}, \frac{b-a}{2}, a \geq b$
 (k) $\pm b(a-b), a \geq b$ (l) $-\frac{b}{a}, \frac{2b}{a}, b \geq 0$ 6. (a) $\frac{1}{3}$ (b) $\frac{2}{3}$ (c) $\frac{3}{2}$ (d) 0 (e) -3, $\frac{1}{3}$ (f) $-\frac{1}{4}$
 7. (a) $-\frac{2a}{3}, 0$ (b) $\pm a$ (c) \emptyset (d) 0, 4a 8. (a) $\pm \frac{3}{2}$ (b) $x \geq 1$

EXERCISE 2.2.2

1. (a) $x < -4$ (b) $x \leq -\frac{1}{5}$ (c) $x > 1$ (d) $x \leq -6$ (e) $x > \frac{18}{7}$ (f) $x > \frac{3}{8}$ 2. (a) $x > \frac{52}{11}$ (b) $x \leq 1$
 (c) $x \leq \frac{10}{3}$ 3. (a) $x < 1$ (b) $x < 2 - a$ (c) $x > \frac{2b}{3a}$ (d) $x \geq \frac{2}{(a+1)^2}$ 4. (a) $-2 \leq x \leq 1$
 (b) $-2 \leq x \leq 3$ (c) $-\frac{3}{2} \leq x \leq \frac{5}{2}$ (d) $x = -\frac{1}{2}$ (e) $-7 \leq x \leq 9$ (f) $-5 \leq x \leq 3$ (g) $-4 \leq x \leq 16$
 (h) $-28 \leq x \leq 44$ (i) $-\frac{5}{12} \leq x \leq \frac{1}{12}$ 5. (a) $x < -\frac{3}{2} \cup x > \frac{5}{2}$ (b) $x < \frac{3}{2} \cup x > \frac{7}{2}$ (c) $x \leq -12 \cup x \geq 16$
 (d) $x \leq -24 \cup x \geq 6$ (e) $x < \frac{3}{4} \cup x > \frac{9}{4}$ (f) $-6 < x < 14$ (g) $x < -28 \cup x > 44$

(h) $x < -\frac{5}{12} \cup x > \frac{1}{12}$ (i) $x \leq -4 \cup x \geq 16$ **6.** $p < 3$ **7.** (a) $-\frac{2}{3} < x < 2$ (b) $-3 \leq x \leq 1$

(c) $0 < x < 2$ **8.** (a) $\frac{a}{1+a} < x < \frac{a}{1-a}$ (b) $\frac{-1}{1+a} < x < \frac{1}{1-a}$ (c) $]-\infty, \frac{-a^2}{a+1}] \cup [\frac{a^2}{a-1}, \infty[$

9. (a) $-\frac{4}{3} < x < \frac{4}{3}$ (b) $-\frac{3}{2} < x < \frac{3}{4}$

EXERCISE 2.3.1

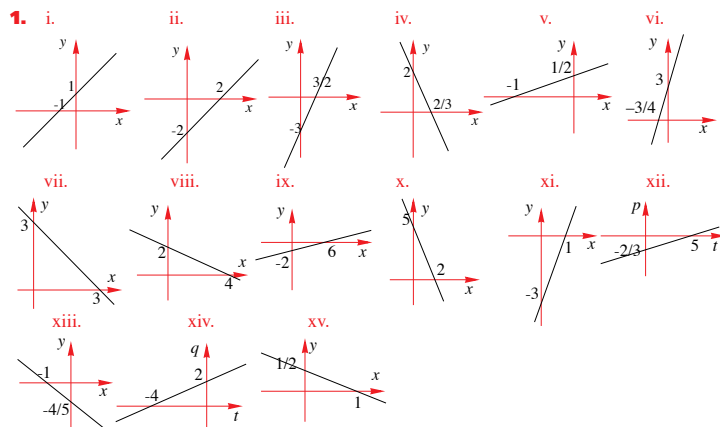

2. (a) 2 (b) 3 (c) $\frac{5}{3}$ **3.** (a) $y = 2x - 1$ (b) $y = 3x + 9$ (c) $y = -x - 1$ **4.** (a) $-\frac{1}{2}$ (b) $\frac{1}{3}$ (c) $\frac{3}{2}$

(d) $-\frac{4}{5}$ **5.** $y = 2x$ **6.** $y = -x + 1$ **7.** $y = \frac{x+2}{2}$ **8. 2** **9.** (a) $y = \frac{5}{2}x$ (b) $y = -\frac{3}{2}x + 3$

(c) $y = \frac{5}{6}x - \frac{1}{2}$ (d) $y = -2x + 1$

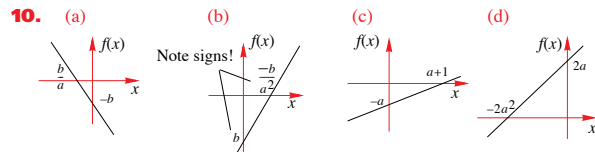

EXERCISE 2.3.2

1. (i) $x = 1, y = 2$ (ii) $x = 3, y = 5$ (iii) $x = -1, y = 2$ (iv) $x = 0, y = 1$ (v) $x = -2, y = -3$

(vi) $x = -5, y = 1$ **2.** (i) $x = \frac{13}{11}, y = \frac{17}{11}$ (ii) $x = \frac{9}{14}, y = \frac{3}{14}$ (iii) $x = 0, y = 0$

(iv) $x = \frac{4}{17}, y = \frac{22}{17}$ (v) $x = -\frac{16}{7}, y = \frac{78}{7}$ (vi) $x = \frac{5}{42}, y = -\frac{3}{28}$ **3.** (i) -3 (ii) -5 (iii) -1.5

4. (i) $m = 2, a = 8$ (ii) $m = 10, a = 24$ (iii) $m = -6, a = 9.$

5. (a) $x = 1, y = a - b$ (b) $x = -1, y = a + b$ (c) $x = \frac{1}{a}, y = 0$ (d) $x = b, y = 0$

(e) $x = \frac{a-b}{a+b}, y = \frac{a-b}{a+b}$ (f) $x = a, y = b - a^2$

EXERCISE 2.3.3

1. (a) $x = 4, y = -5, z = 1$ (b) $x = 0, y = 4, z = -2$ (c) $x = 10, y = -7, z = 2$

(d) $x = 1, y = 2, z = -2$ (e) \emptyset (f) $x = 2t - 1, y = t, z = t$ (g) $x = 2, y = -1, z = 0$ (h) \emptyset

EXERCISE 2.4.1

1. (a) -5 (b) 4, 6 (c) -3, 0 (d) 1, 3 (e) -6, 3 (f) -2, $\frac{5}{3}$ (g) 2 (h) -3, 6 (i) -6, 1 (j) 0, $\frac{3}{2}$

2. (a) -1 (b) -7, 5 (c) $-\frac{2}{5}, 3$ (d) -2, 1 (e) -3, 1 (f) 4, 5

3. (a) $-1 \pm \sqrt{6}$ (b) $3 \pm \sqrt{5}$ (c) $1 \pm \sqrt{5}$ (d) $\frac{-1 \pm \sqrt{33}}{8}$ (e) $\frac{9 \pm \sqrt{73}}{4}$ (f) $\frac{1 \pm \sqrt{85}}{6}$

4. (a) $\frac{3 \pm \sqrt{37}}{2}$ (b) $\frac{5 \pm \sqrt{33}}{2}$ (c) $\frac{3 \pm \sqrt{33}}{2}$ (d) $\frac{7 \pm \sqrt{57}}{2}$ (e) $\frac{-7 \pm \sqrt{65}}{2}$ (f) -4, 2 (g) $-1 \pm 2\sqrt{2}$

(h) $\frac{-5 \pm \sqrt{53}}{2}$ (i) $\frac{3 \pm \sqrt{37}}{2}$ (j) no real solutions (k) $4 \pm \sqrt{7}$ (l) no real solutions (m) $\frac{2 \pm \sqrt{13}}{2}$

(n) $\frac{3 \pm 2\sqrt{11}}{5}$ (o) $\frac{6 \pm \sqrt{31}}{5}$ (p) $\frac{6 \pm \sqrt{29}}{7}$ **5.** (a) $-2 < p < 2$ (b) $p = \pm 2$ (c) $p < -2$ or $p > 2$

6. (a) $m = 1$ (b) $m < 1$ (c) $m > 1$ **7.** (a) $m = \pm 2\sqrt{2}$ (b) $]-\infty, -2\sqrt{2}[\cup]2\sqrt{2}, \infty[$

(c) $]-2\sqrt{2}, 2\sqrt{2}[$ **8.** (a) $k = \pm 6\sqrt{2}$ (b) $]-\infty, -6\sqrt{2}[\cup]6\sqrt{2}, \infty[$ (c) $]-6\sqrt{2}, 6\sqrt{2}[$ **10.** 4

EXERCISE 2.4.2

1. Graphs are shown using the ZOOM4 viewing window:

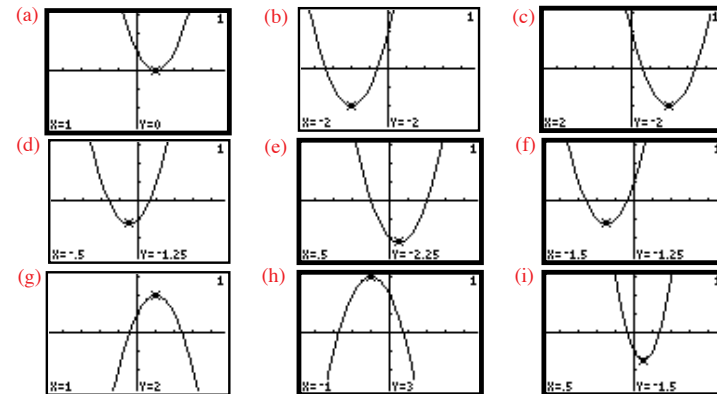

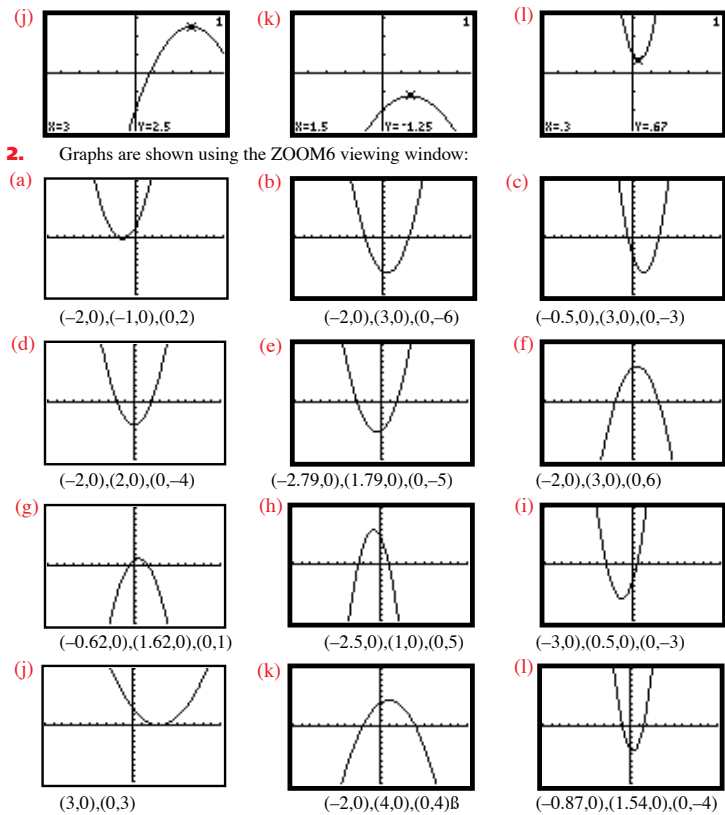

3. (a) $x=1$ (b) $(1,-1)$ (c) i. $(\frac{2 \pm \sqrt{2}}{2}, 0)$ ii. $(0,1)$

(c) i. $(\frac{2 \pm 3\sqrt{2}}{2}, 0)$ ii. $(0,7)$

(b) $k < \frac{25}{8}$ (c) $k > \frac{25}{8}$ 7. (a) $k = \pm 1$ (b) $-1 < k < 1$ (c) $k < -1 \cup k > 1$

8. (a) $y = \frac{5}{12}(x-2)(x-6)$ (b) $y = -\frac{3}{8}(x+4)^2$ (c) $y = \frac{3}{4}(x-2)^2 + 1$ (d) $y = 3x^2 - 6x + 7$

9. (a) $y = -\frac{2}{3}x(x-6)$ (b) $y = \frac{3}{4}(x-3)^2$ (c) $y = \frac{7}{9}(x+2)^2 + 3$ (d) $y = -\frac{7}{3}x^2 - 2x + \frac{40}{3}$

EXERCISE 2.4.3

1. (a) $]-\infty, -2[\cup]1, \infty[$ (b) $[-3, 2]$ (c) $]-\infty, 0[\cup]4, \infty[$ (d) $[\frac{1}{3}, 3[$ (e) $]-\infty, -1.5[\cup]-1, \infty[$ (f) $]0.75, 2.5[$

2. (a) $]-\infty, -2[\cup]-1, \infty[$ (b) $[-2, 3[$ (c) $]-\infty, -0.5[\cup]3, \infty[$ (d) $[-2, 2]$ (e) $]-\frac{1-\sqrt{21}}{2}, -\frac{1+\sqrt{21}}{2}[$

(f) $]-\infty, -2[\cup]3, \infty[$ (g) $[\frac{1-\sqrt{5}}{2}, \frac{1+\sqrt{5}}{2}]$ (h) $[-2.5, 1]$ (i) $]-\infty, -3[\cup]0.5, \infty[$ (j) $]1, 3[$ (k) $]-1, 0.5[$ (l) \emptyset

(m) \emptyset (n) $[-1.5, 5]$ (o) $]-\infty, -2[\cup]\frac{1}{3}, \infty[$ 3. (a) $-1 < k < 0$ (b) $-2\sqrt{2} < k < 2\sqrt{2}$ (c) $n \leq -0.5$

4. (a) i. $]-\infty, -1[\cup]2, \infty[$ ii. $[-1, 2]$ (b) i. $]-\infty, 2[\cup]3, \infty[$ ii. $[2, 3]$ (c) i. $]1, 3[$ ii. $]-\infty, 1[\cup]3, \infty[$

(d) i. $]-\frac{2}{3}, 1[$ ii. $]-\infty, -\frac{2}{3}[\cup]1, \infty[$ (e) i. $]-\infty, -2[\cup]2, \infty[$ ii. $[-2, 2]$ (f) i. $]2-\sqrt{3}, 2+\sqrt{3}[$

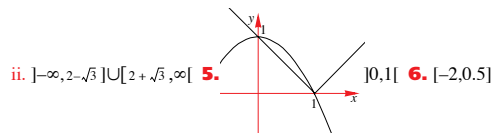

7. (a) i. $]2-\sqrt{6}, 2-\sqrt{2}[\cup]2+\sqrt{2}, 2+\sqrt{6}[$ ii. $]2(1-\sqrt{3}), 2(1+\sqrt{3}) \setminus \{2\}$ iii. $]2(1-\sqrt{3}), 2(1+\sqrt{3})$

(b) i. $[\frac{5-\sqrt{13}}{3}, \frac{1+\sqrt{13}}{2}]$ ii. all real values 8. (a) $\{x: x < -3\} \cup \{x: x > 2\}$ (b) $\{x: -1 < x < 4\}$

(c) i. $\{x: x < 0.5\}$ ii. $\{x: -2 < x < 0\}$ 9. (a) i. $]0, 1[$ ($k=1$); $]-1, 0[$ ($k=-1$) ii. \emptyset (b) $k > 1.25$

EXERCISE 2.4.4

1. (a) $(-2, -3)$ (2, 5) (b) $(-2, -1)$ (1, 2) (c) $(-\frac{1}{3}, -2)$, (2, 5) (d) $(-\frac{3}{2}, -\frac{15}{4})$, (1, 0)

(e) $(-\frac{9}{2}, -\frac{19}{4})$, (1, -2) (f) $(\frac{3+\sqrt{73}}{4}, -\frac{3-\sqrt{73}}{8})$, $(\frac{3-\sqrt{73}}{4}, -\frac{3+\sqrt{73}}{8})$

(g) $(\frac{1-\sqrt{13}}{2}, 1-\sqrt{13})$, $(\frac{1+\sqrt{13}}{2}, 1+\sqrt{13})$ (h) no real solutions

(i) $(\frac{1-\sqrt{17}}{2}, \frac{5-3\sqrt{17}}{2})$, $(\frac{1+\sqrt{17}}{2}, \frac{5+3\sqrt{17}}{2})$ (j) $(-2, -3)$, (2, 1) (k) no real solutions

2. (a) (1, 4), (-7, 84) (b) $(\frac{4}{3}, -\frac{56}{9})$, $(\frac{3}{4}, -\frac{7}{4})$ (c) (0, 2), (3, 23) (d) $(-a, -a^2)$, $(\frac{a}{2}, \frac{a^2}{2})$ (e) \emptyset

(f) (2, 8) (g) \emptyset (h) $(\frac{1}{2}, \frac{23}{4})$ 3. (a) $\pm 2\sqrt{6}$ (b) $m < -2\sqrt{6}$, $m > 2\sqrt{6}$ (c) $-2\sqrt{6} < m < 2\sqrt{6}$

4. $\sqrt{80}$ 5. 1.75 7. $-\frac{23}{12}$ 9. $(-\infty, -3) \cup (1, \infty)$ 10. 0.5 11. $c = \frac{a}{m}$

13. (a) i. (1, 3), $(-\frac{14}{3}, \frac{196}{3})$ ii. (-2, 12), $(\frac{7}{3}, \frac{49}{3})$ (c) i. A(1, 3), B(-2, 2) ii. 4 sq. units

EXERCISE 3.1

1. (a) $-2x^3 + 6x^2 + x - 7$ (b) $x^4 - x^3 + 12x^2 + 2x - 9$ (c) $6x^5 - 7x^3 + 9x^2 + 2x - 6$
 (d) $2x^7 - 2x^6 - x^5 + 8x^4 - 5x^3 - 2x^2 + 7x - 3$ (e) $4x^6 - 4x^4 + 12x^3 + x^2 - 6x + 9$
 (f) $9x^3 - 12x^2 - 18x + 13$ 2. $3x + 1 + \frac{2}{x-1}$ 3. $2x^2 - 3x + 11 - \frac{8}{2x-1}$
 4. $x^2 - x - 5 + \frac{19-6x}{x^2-2x+3}$ 5. $2x^2 - 7x + 7 - \frac{17}{x+1}$ 6. $x^2 - 1 + \frac{3-x}{x^2+3}$
 7. $(3x-1)(\frac{16}{3} - 3x - 2x^2) + \frac{52}{3}$ 8. 1 9. -1 10. -12 11. 5

EXERCISE 3.2

1. $(x-1)(2x-3) - 2$ 2. $(x-3)(3x^2 + 10x + 29) + 90$ 3. $(x+3)(2x^3 - 7x^2 + 19x - 57) + 174$
 4. $(2x-1)(x^2 - 2x + 4) + 1$ 5. $(x+2)(2x^3 - 4x^2 + 11x - 23) + 46$
 6. $(4-x)(x^3 + 4x^2 + 18x + 72) - 283$

EXERCISE 3.3

1. (a) -6 (b) 15 (c) 8 (d) 1.25 (e) $-\frac{155}{27}$ 2. 6 3. (a) 7 (b) 70 (c) $-21x + 28$ 4. -6 5. (a) 11 (b) 3

EXERCISE 3.4

1. (a) $(x-3)(x-2)(x+5)$ (b) $(x-2)(x^2 + 3x + 5)$ (c) $(x-2)(x-1)(x+2)$
 (d) $(x-2)(x+2)(3x+1)$ (e) $(x-3)(x+3)(2x-1)$ (f) $(x-2)(x-1)(x^2 + 3x + 4)$
 (g) $(x-2)^2(x+3)$ (h) $(x-2)^2(5x-4)$ (i) $-(x+4)(2x-5)(5x+2)$ (j) $-(x+1)^2(5x-1)$
 2. $6x^3 - 4x^2 - 2x + 3$ 3. $-\frac{47}{8}$ 4. 0, $(x+4)(x+1)(x-3)$ 5. $(2x+1)(x+2)^2$
 6. $(x-5)(x^2 + x + 2)$ 7. $(x-1)^2(2x-1)(3x+2)$ 8. (a) $-(x-1)(x+2)(3x-1)^2$ (b) 1, $-2, \frac{1}{3}$
 9. $a = -1, b = -2$ 11. $a = -2, b = 1$ 13. $a = -9, b = 24, (6x^2 + 9x - 2)$
 14. $x^3 - 2x^2 + 8x + 2$ 15. $3x^3 - 5x^2 + 6x + 4$ 16. $a + c = b + d$ 17. -8
 18. $a = 1, b = -3, c = 3, d = -1$ 19. $(x-2)(2x+1)(3x+2)$
 20. (a) $m = \frac{18}{5}, n = \frac{39}{5}, k = -\frac{78}{5}$ (b) $(x-2), (x+3)$
 21. $m = 3, n = -4, k = -12; x^3 + 3x^2 - 4x - 12 = (x-2)(x+2)(x+3)$
 22. $k = -2, n = 3$ 24. $a = 3, b = -6; a = -3, b = 6$ 26. $(\alpha^2 + \alpha\beta + \beta^2)x - \alpha\beta(\alpha + \beta)$

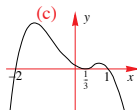

EXERCISE 3.5.1

1. (a) -3, -1, 2 (b) $-\frac{1}{2}, 1, 2$ (c) -2, -1, 3 (d) $\frac{1}{3}, \frac{3}{2}, 4$ (e) $\frac{1}{2}$ (f) -1, 3 (g) -4, 1 (h) -2, $2 \pm \sqrt{10}$
 (i) $-\frac{1}{2}, -2 \pm \sqrt{2}$ (j) $\frac{1}{3}, \pm\sqrt{6}$ 2. $\frac{1}{2}, 1, 5$ 3. $-\frac{3}{2}, \frac{1}{2}, 2$ 4. -1, -2, 3 5. -4, 1
 6. (a) $(x+2)(x-3)(x+4) = 0$ (b) $(x+1)(x-0.5)(x-2) = 0$ (c) $8x^3 - 16x^2 - 2x + 4 = 0$
 7. (a) $-\frac{7 \pm \sqrt{337}}{12}, 1$ (b) -1, 1 (c) -4, -1, 2 (d) $1, \frac{3}{2}, 3$ 8. (a) -1.75, 0.432, 1.32 (b) 3.77
 (c) 0.309 (d) -1.68, -0.421, 0.421, 1.68 9. -3, $-\frac{1}{2}, 2$ 10. No other solutions
 11. $m = 1, n = -6; x = 6, -1, 2$ 12. 1, 4, 7

EXERCISE 3.5.2

1. (a) $[-1, 1] \cup [2, \infty)$ (b) $]-\infty, -2] \cup [2, 3]$ (c) $[-3, -2] \cup [2, \infty[$ (d) $]0, \infty[\setminus \{1\}$ (e) $\{-2\} \cup [-0.5, \infty[$
 (f) $]-\infty, -4] \cup]-2, 2[$ (g) $]-\infty, 1] \cup [2, \infty[\setminus \{-1\}$ (h) $]-\infty, 2] \cup \{3\}$
 2. (a) $]-3, -1] \cup [2, \infty[$ (b) $]-\infty, -\frac{1}{2}] \cup [1, 2]$ (c) $[-2, -1] \cup [3, \infty[$ (d) $]-\frac{1}{3}, \frac{3}{2}] \cup [4, \infty[$ (e) $[\frac{1}{2}, \infty[$
 (f) $]3, \infty[$ (g) $]-\infty, -4[$ (h) $[-2, 2 - \sqrt{10}] \cup [2 + \sqrt{10}, \infty[$ (i) $]-\infty, -2 - \sqrt{2}] \cup [-2 + \sqrt{2}, -\frac{1}{2}]$
 (j) $]-\infty, -\sqrt{6}] \cup [\frac{1}{3}, \sqrt{6}[$ (k) $]-\infty, 1]$ (l) $]-\infty, \frac{1-\sqrt{13}}{2}] \cup [\frac{1+\sqrt{13}}{2}, \infty[$

EXERCISE 3.6

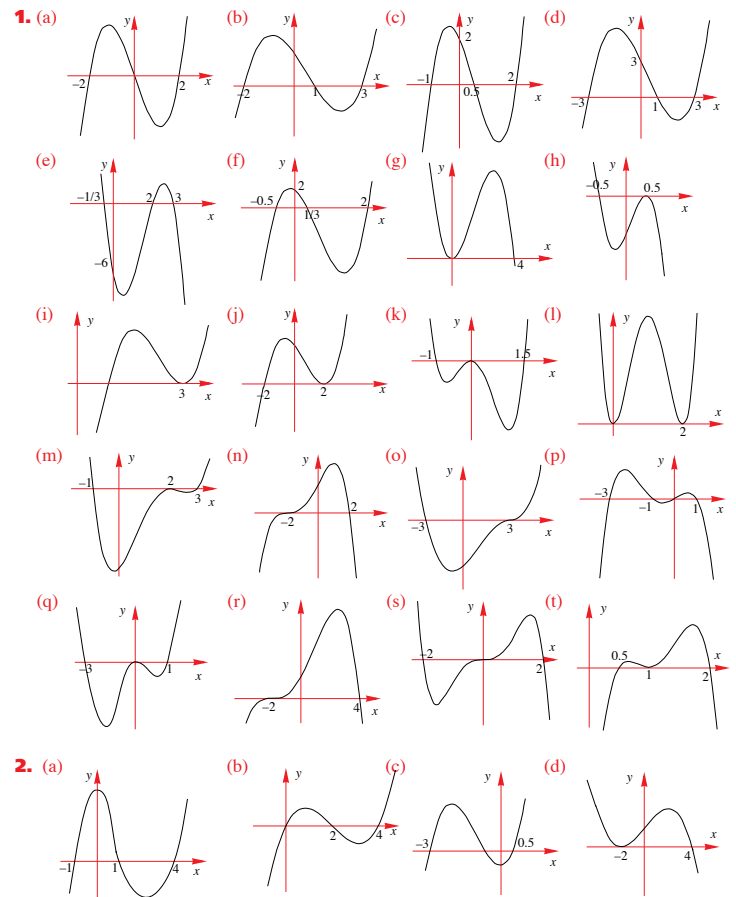

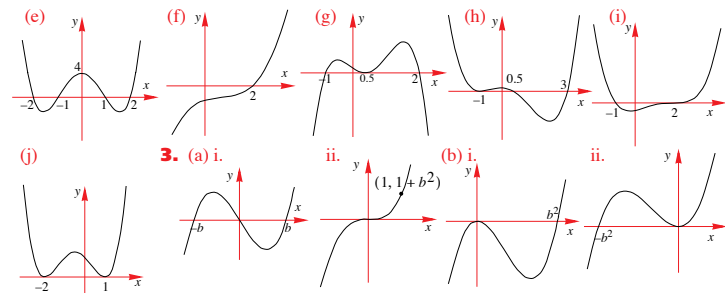

4. (a) $y = -\frac{1}{15}(x+3)(x-1)(x-5)$ (b) $y = \frac{1}{8}(x-2)^2(x+4)$ (c) $y = -\frac{3}{2}x^2(x-3)$
 (d) $y = \frac{1}{30}(x+2)^2(75-29x)$ (e) $y = \frac{1}{6}(x+2)(4-3x)(x-3)$ (f) $y = -x^3 - x^2 + 2x + 8$

5. (a) $y = \frac{1}{2}(x+2)(x-2)^3$ (b) $y = \frac{1}{35}x^2(x-3)(x-5)$ (c) $y = -\frac{1}{6}(x+2)^2(x-1)(x-3)$

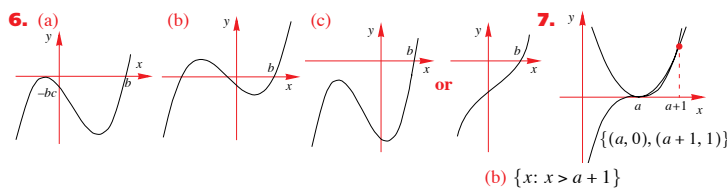

EXERCISE 4.1.1

1. (a) $b^2 + 2bc + c^2$ (b) $a^3 + 3a^2g + 3ag^2 + g^3$ (c) $1 + 3y + 3y^2 + y^3$
 (d) $16 + 32x + 24x^2 + 8x^3 + x^4$ (e) $8 + 24x + 24x^2 + 8x^3$ (f) $8x^3 - 48x^2 + 96x - 64$
 (g) $16 + \frac{32}{7}x + \frac{24}{49}x^2 + \frac{8}{343}x^3 + \frac{1}{2401}x^4$ (h) $8x^3 - 60x^2 + 150x - 125$
 (i) $27x^3 - 108x^2 + 144x - 64$ (j) $27x^3 - 243x^2 + 729x - 729$ (k) $8x^3 + 72x^2 + 216x + 216$
 (l) $b^3 + 9b^2d + 27bd^2 + 27d^3$ (m) $81x^4 + 216x^3y + 216x^2y^2 + 96xy^3 + 16y^4$
 (n) $x^5 + 15x^4y + 90x^3y^2 + 270x^2y^3 + 405xy^4 + 243y^5$ (o) $\frac{125}{p^3} + \frac{150}{p} + 60p + 8p^3$
 (p) $\frac{16}{x^4} - \frac{32}{x} + 24x^2 - 8x^5 + x^8$ (q) $q^5 + \frac{10q^4}{p^3} + \frac{40q^3}{p^6} + \frac{80q^2}{p^9} + \frac{80q}{p^{12}} + \frac{32}{p^{15}}$ (r) $x^3 + 3x + \frac{3}{x} + \frac{1}{x^3}$

EXERCISE 4.1.2

1. (a) $160x^3$ (b) $21x^5y^2$ (c) $-448x^3$ (d) $-810x^4$ (e) $216p^4$ (f) $-20412p^2q^5$ (g) $-22680p$
 2. (a) -1400000 (b) 6000 (c) 540 (d) -240 (e) 81648 (f) 40 3. 1.0406 0.0004%
 4. i. $64x^6 + 960x^5 + 6000x^4 + 20000x^3 + 37500x^2 + 37500x + 15625$ ii. 19750 iii. 20.6
 iv. 0.1% 5. 19 6. $\frac{63}{8}$ 7. $\frac{231}{16}$ 8. $-\frac{130}{27}$ 9. -20 10. $a = \pm 3$ 11. $n = 5$ 12. $n = 9$
 13. (a) 0 (b) -59 14. $a = 3, n = 8$ 15. $a = \pm 2, b = \pm 1$

ANSWERS - 8

EXERCISE 5.1

1. (a) $\text{dom} = \{2, 3, -2\}$, $\text{ran} = \{4, -9, 9\}$ (b) $\text{dom} = \{1, 2, 3, 5, 7, 9\}$, $\text{ran} = \{2, 3, 4, 6, 8, 10\}$
 (c) $\text{dom} = \{0, 1\}$, $\text{ran} = \{1, 2\}$ 2. (a) $]1, \infty[$ (b) $]0, \infty[$ (c) $]9, \infty[$ (d) $]-\infty, 1[$ (e) $]-3, 3[$
 (f) $]-\infty, \infty[$ (g) $]-1, 0[$ (h) $]0, 4[$ (i) $]0, \infty[$ (j) $]1, 5[$ (k) $]0, 4[$ (l) $]-\infty, -1[\cup]1, \infty[$
 3. (a) $r = [-1, \infty[$, $d = [0, 2[$ (b) $r = \{y: y \geq 0\} \setminus \{4\}$, $d = \mathbf{R}$ (c) $r = [0, \infty[\setminus \{3\}$, $d = [-4, \infty[\setminus \{0\}$
 (d) $r = [-2, 0[$, $d = [-1, 2[$ (e) $r =]-\infty, \infty[$, $d =]-\infty, -3[\cup]3, \infty[$ (f) $r = [-4, 4]$, $d = [0, 8]$
 4. (a) one to many (b) many to one (c) many to one (d) one to one (e) many to many
 (f) one to one 5. (a) $\mathbf{R} \setminus \{-2\}$ (b) $]-\infty, 9[$ (c) $]-4, 4[$ (d) $]-\infty, -2[\cup]2, \infty[$ (e) $\mathbf{R} \setminus \{0\}$ (f) \mathbf{R}
 (g) $\mathbf{R} \setminus \{-1\}$ (h) $]-a, \infty[$ (i) $]0, \infty[\setminus \{a^2\}$ (j) $]-\infty, -a[\cup]a, \infty[$ (k) \mathbf{R} (l) $\mathbf{R} \setminus \{-a^{-1}\}$
 6. (a) $]-\infty, -a[$ (b) $]0, ab[$ (c) $]-\infty, \frac{1}{4}a^3[$ (d) $]\frac{1}{4}a^3, \infty[$ (e) $\mathbf{R} \setminus \{a\}$ (f) $]-\infty, a[$ (g) $]-a, \infty[$ (h) $]-\infty, 0[$

EXERCISE 5.2

Graphs with graphics calculator output have standard viewing window unless otherwise stated.

1. (a) $3, 5$ (b) i. $2(x+a) + 3$ ii. $2a$ (c) 3 2. (a) $0, \frac{10}{11}$ (b) $-\frac{5}{4}$ (c) $]\frac{10}{11}, \infty[$

3. (a) $-\frac{1}{2}x^2 - x + \frac{3}{2}$, $-\frac{1}{2}x^2 + x + \frac{3}{2}$ (b) $\pm\sqrt{2}$ (c) no solution

4. (a) $x = 0, 1$

5. (a) i.

ii.



Window $[-2, 2]$, $[-1, 1]$
 Range: $[-12, 4]$

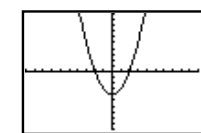

(b) i. $\{2\sqrt{2}, -2\sqrt{2}\}$ ii. $\{3, -2\}$

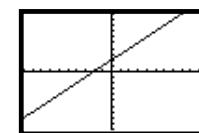

6. (b), (c), (d), (e) 8. (a), (d), (e), (f) 10. (a) $\{y: y > 1\} \cup \{y: y \leq -1.25\}$ (b) 10 11. (b) 1
 12. (a) only - it is the only one with identical rules &

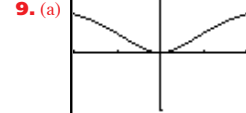

Window $[-2, 2]$, $[-1, 1]$
 (b) $[0, 1]$

- domains.

13. (a) $]-3, \infty[$ (b) $]-3, 0[$ (c) $]3, \infty[$ (d) $]1.5, 3[\cup]3, \infty[$

14. (a) i. $p(x) = 8 + 2\sqrt{16 - x^2}$, $0 < x < 4$

ii. $A(x) = x\sqrt{16 - x^2}$, $0 < x < 4$

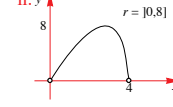
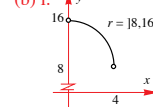

EXERCISE 5.3.1

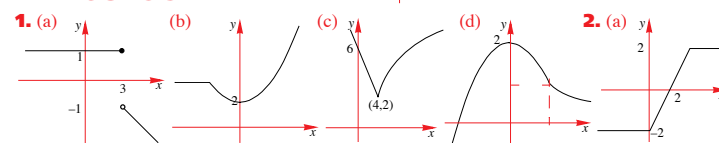

ANSWERS - 9

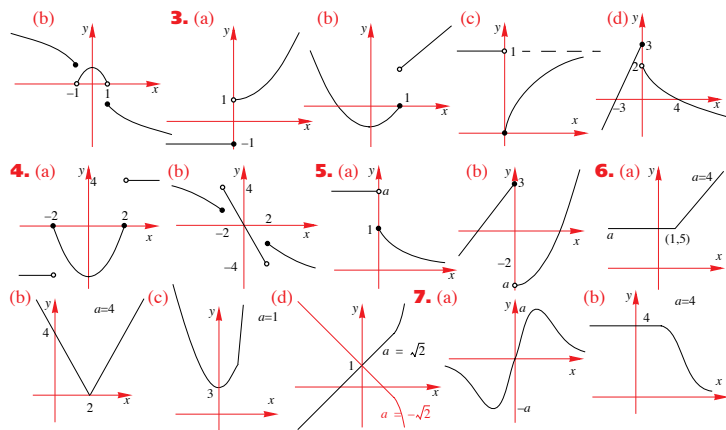

EXERCISE 5.3.2

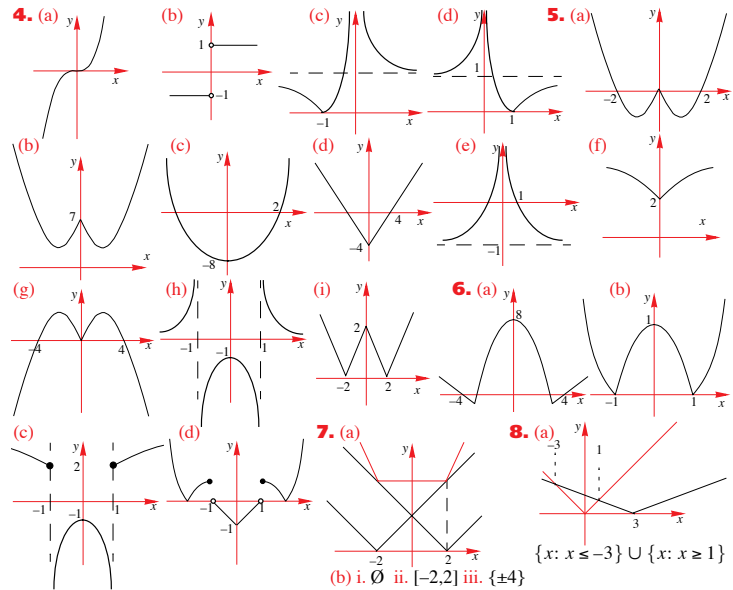
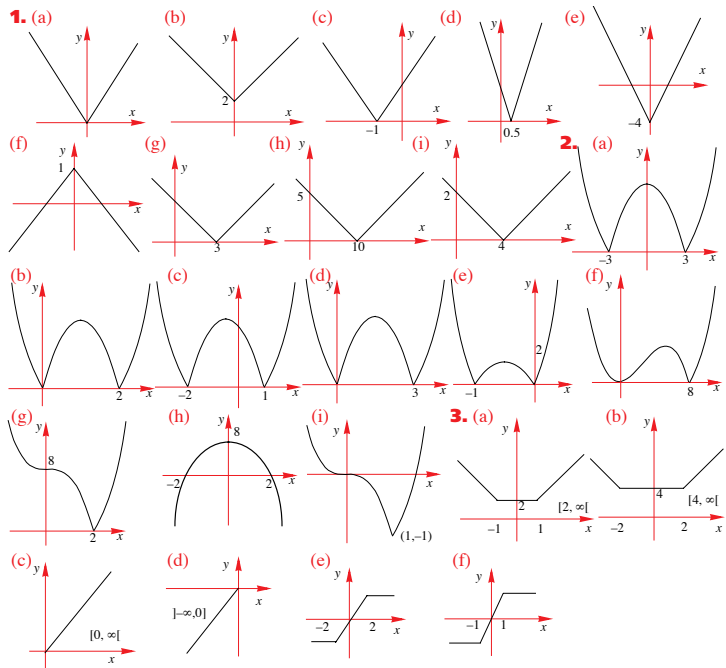

EXERCISE 5.3.3

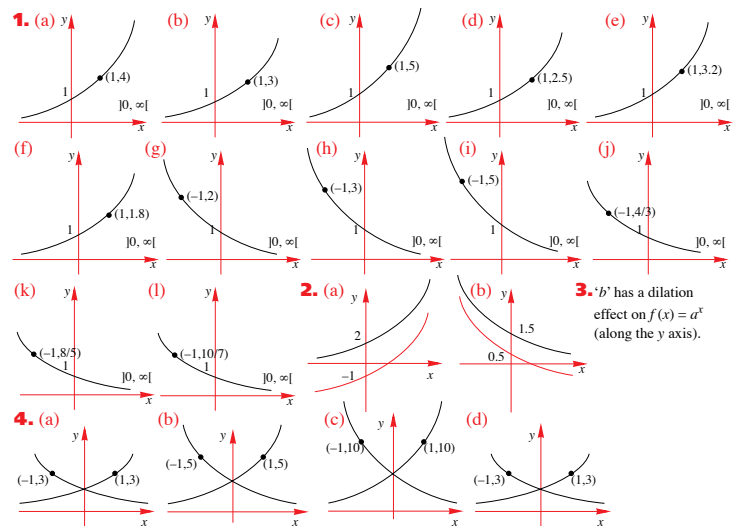

5. (a) $[1, 16]$ (b) $[3, 27]$ (c) $[0.25, 16]$ (d) $[0.5, 4]$ (e) $[0.125, 0.25]$ (f) $[0.1, 10]$

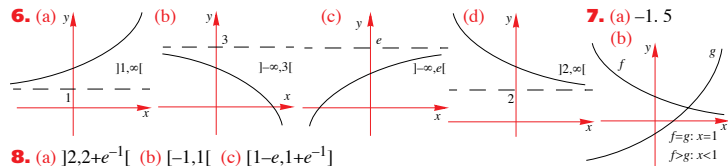

8. (a) $[2, 2+e^{-1}]$ (b) $[-1, 1[$ (c) $[1-e, 1+e^{-1}]$

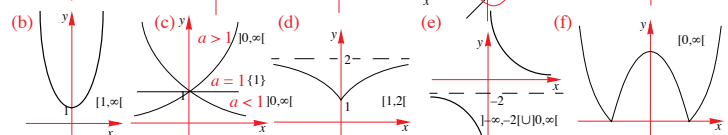
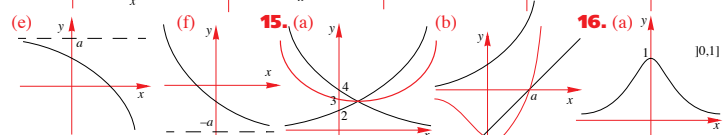
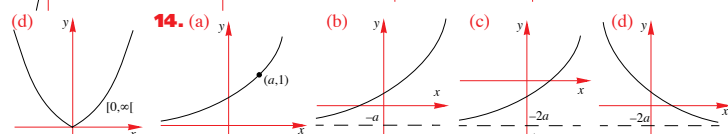
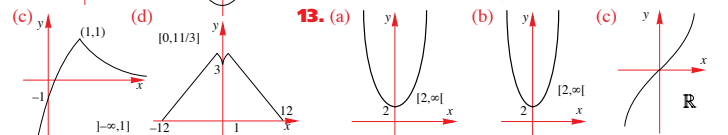
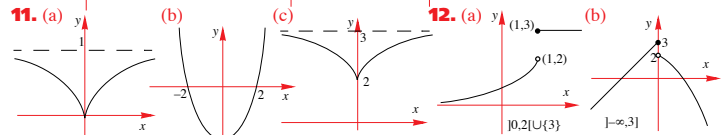
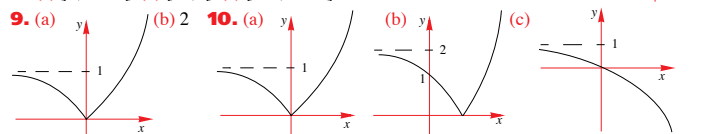

EXERCISE 5.3.4

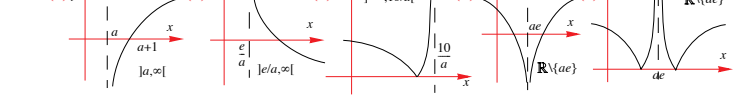
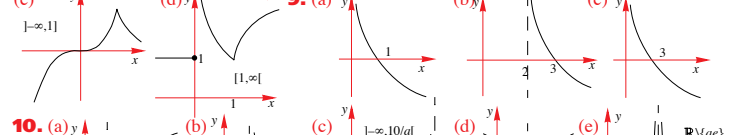
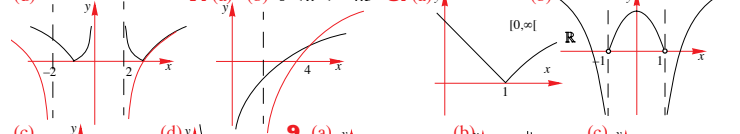
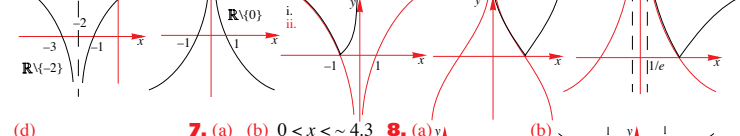
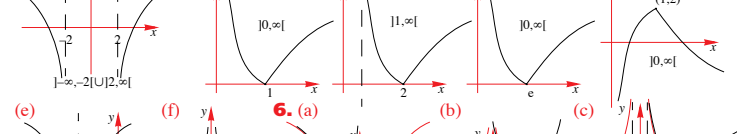
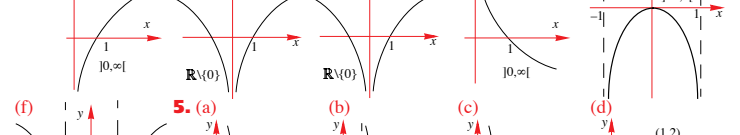
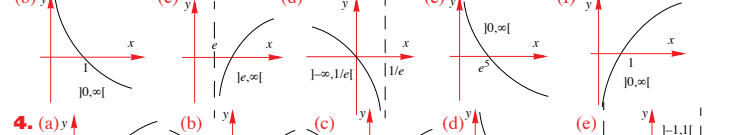
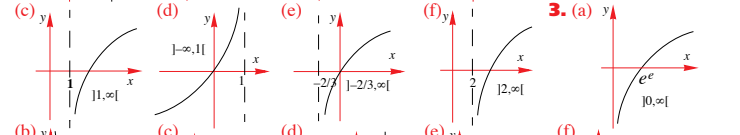
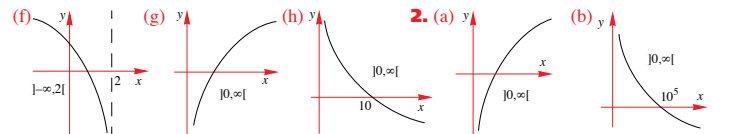
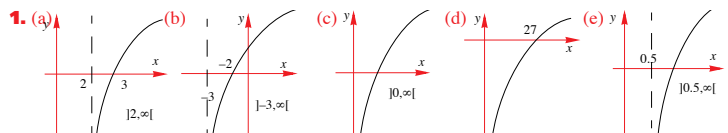

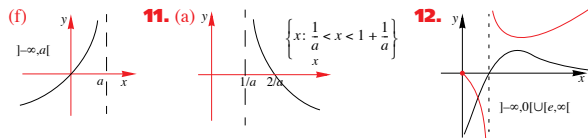

EXERCISE 5.3.5

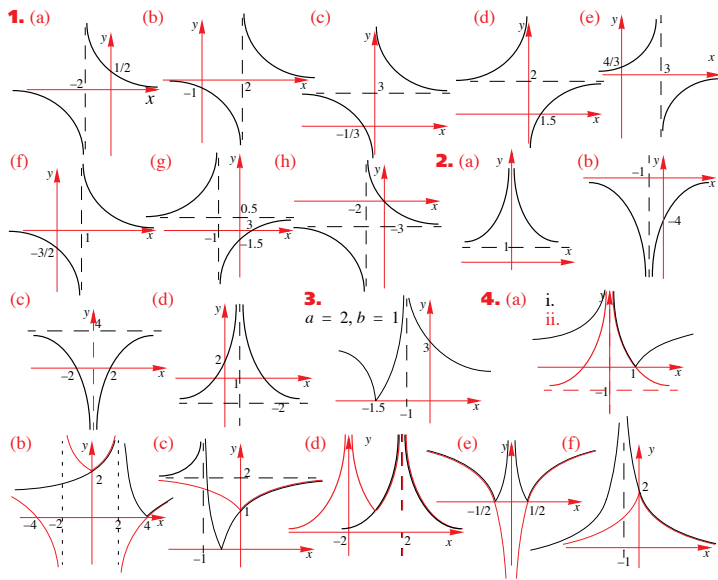

EXERCISE 5.4.1

1. (a) i. $f + g: [0, \infty[\rightarrow \mathbb{R}$ where $(f + g)(x) = x^2 + \sqrt{x}$ $[0, \infty[$
 ii. $f + g:]0, \infty[\rightarrow \mathbb{R}$ where $(f + g)(x) = \frac{1}{x} + \ln(x)$ $[1, \infty[$
 iii. $f + g: [-3, -2] \cup [2, 3] \rightarrow \mathbb{R}$ where $(f + g)(x) = \sqrt{9 - x^2} + \sqrt{x^2 - 4}$ $[\sqrt{5}, \sqrt{10}]$
 (b) i. $f \cdot g: [0, \infty[\rightarrow \mathbb{R}$ where $(f \cdot g)(x) = x^2 \sqrt{x} = x^{5/2}$
 ii. $f \cdot g:]0, \infty[\rightarrow \mathbb{R}$ where $(f \cdot g)(x) = \frac{\ln(x)}{x}$
 iii. $f \cdot g: [-3, -2] \cup [2, 3] \rightarrow \mathbb{R}$ where $(f \cdot g)(x) = \sqrt{(9 - x^2)(x^2 - 4)}$
 2. (a) i. $f - g:]-\infty, \infty[\rightarrow \mathbb{R}$ where $(f - g)(x) = 2e^x - 1$ $]-1, \infty[$
 ii. $f - g:]-1, \infty[\rightarrow \mathbb{R}$ where $(f - g)(x) = (x + 1) - \sqrt{x + 1}$ $]-0.25, \infty[$
 iii. $f - g:]-\infty, \infty[\rightarrow \mathbb{R}$ where $(f - g)(x) = |x - 2| - |x + 2|$ $[-4, 4]$
 (b) i. $f/g: \mathbb{R} \setminus \{0\} \rightarrow \mathbb{R}$ where $(f/g)(x) = \frac{e^x}{1 - e^x}$

- ii. $f/g:]-1, \infty[\rightarrow \mathbb{R}$ where $(f/g)(x) = \sqrt{x + 1}$
 iii. $f/g: \mathbb{R} \setminus \{-2\} \rightarrow \mathbb{R}$ where $(f/g)(x) = \frac{x - 2}{x + 2}$
 3. i. (a) $f \circ g(x) = x^3 + 1$, $g \circ f(x) = (x + 1)^3$ (b) $]-\infty, \infty[$, $]-\infty, \infty[$
 ii. (a) $f \circ g(x) = x + 1, x \geq 0$, $g \circ f(x) = \sqrt{x^2 + 1}$ (b) $[1, \infty[$, $[1, \infty[$
 iii. (a) $f \circ g(x) = x^2$, $g \circ f(x) = (x + 2)^2 - 2$ (b) $[0, \infty[$, $[-2, \infty[$
 iv. (a) $f \circ g(x) = x, x \neq 0$, $g \circ f(x) = x, x \neq 0$ (b) $\mathbb{R} \setminus \{0\}$, $\mathbb{R} \setminus \{0\}$
 v. (a) $f \circ g(x) = x, x \geq 0$, $g \circ f(x) = |x|$ (b) $[0, \infty[$, $[0, \infty[$
 vi. (a) $f \circ g(x) = \frac{1}{x^2} - 1, x \neq 0$, $g \circ f(x)$ does not exist (b) $]-1, \infty[$
 vii. (a) $f \circ g(x) = x^2, x \neq 0$, $g \circ f(x) = x^2, x \neq 0$ (b) $]0, \infty[$, $]0, \infty[$
 viii. (a) $f \circ g(x) = |x| - 4$, $g \circ f(x) = |x - 4|$ (b) $[-4, \infty[$, $[0, \infty[$
 ix. (a) $f \circ g(x) = |x + 2|^3 - 2$, $g \circ f(x) = |x^3|$ (b) $[-2, \infty[$, $[0, \infty[$
 x. (a) $f \circ g(x)$ does not exist, $g \circ f(x) = (4 - x), x \leq 4$ (b) $[0, \infty[$
 xi. (a) $f \circ g(x) = \frac{x^2}{x^2 + 1}$, $g \circ f(x) = \left(\frac{x}{x + 1}\right)^2, x \neq -1$ (b) $]0, 1[$, $[0, \infty[$
 xii. (a) $f \circ g(x) = x^2 + |x| + 1$, $g \circ f(x) = |x^2 + x + 1|$ (b) $[1, \infty[$, $[0.75, \infty[$
 xiii. (a) $f \circ g(x) = 2^{x^2}$, $g \circ f(x) = 2^{2x}$ (b) $[1, \infty[$, $]0, \infty[$
 xiv. (a) $f \circ g(x)$ does not exist, $g \circ f(x) = \frac{1}{x + 1} - 1, x \neq -1$ (b) $\mathbb{R} \setminus \{-1\}$
 xv. (a) $f \circ g(x)$ does not exist, $g \circ f(x) = \frac{4}{x - 1} + 1$ (b) $]1, \infty[$
 xvi. (a) $f \circ g(x) = 4\sqrt{x}, x \geq 0$, $g \circ f(x) = 4^{0.5x}$ (b) $[1, \infty[$, $]0, \infty[$
 4. (a) $f \circ g(x) = 2x + 3, x \in \mathbb{R}$ (b) $g \circ f(x) = 2x + 2, x \in \mathbb{R}$ (c) $f \circ f(x) = 4x + 3, x \in \mathbb{R}$
 5. $g(x) = x^2 + 1, x \in \mathbb{R}$ 6. (a) $f \circ g(x) = \frac{1}{x} + x + 1, x \in \mathbb{R} \setminus \{0\}$, $]-\infty, -1[\cup]3, \infty[$
 (b) $g \circ f(x)$ does not exist. (c) $g \circ g(x) = x + \frac{1}{x} + \frac{x}{x^2 + 1}, x \neq 0$, $]-\infty, -2.5[\cup]2.5, \infty[$
 7. (a) 9 (b) 3 9. (a) $x = \pm 1$ (b) $x = 1, -3$ 10. (a) $\frac{1}{x}$ (b) $\frac{-x}{2x + 1}$
 11. $h \circ f(x) = \begin{cases} (x - 1)^2 + 4, & x \geq 2 \\ 5 - x, & x < 2 \end{cases}$ 12. (a) $r_f \subseteq d_g$ and $r_{g \circ f} \subseteq d_h$ (b) $g(x) = 4(x + 1)^2, x \in \mathbb{R}$
 13. (a) $f \circ g(x) = x, x \in]0, \infty[$ range = $]0, \infty[$
 (b) $g \circ f(x) = \frac{1}{2}(\ln(e^{2x-1}) + 1), x \in \mathbb{R}$ (=x) range = $]-\infty, \infty[$
 (c) $f \circ f(x) = e^{2(e^{2x-1})-1}, x \in \mathbb{R}$ range = $|e^{-1}, \infty[$
 14. (a) $h \circ k$ does not exist.
 (b) $k \circ h(x) = 4 \log(4x - 1) - 1, x > \frac{1}{4}$, \mathbb{R}
 15. (a) $S = \mathbb{R} \setminus]-3, 3[$; $T = \mathbb{R}$ (b) $T = \{x: |x| \geq 6, x = 0\}$; $S =]-\infty, -3[\cup]3, \infty[$

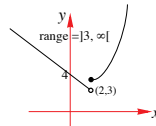

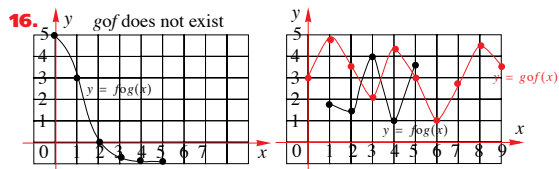

17. (a) $\text{Dom } f =]0, \infty[$, $\text{ran } f =]e, \infty[$, $\text{Dom } g =]0, \infty[$, $\text{ran } g = \mathbb{R}$

(b) gof does not exist: $r_g \not\subseteq d_f =]0, \infty[$

gof exists as $r_f =]e, \infty[\subseteq d_g =]0, \infty[$

(c) $\text{gof}:]0, \infty[\rightarrow \mathbb{R}$, where $\text{gof}(x) = (x+1) + \ln 2$

18. $(f \circ g)(x) = |x|$, $x \in \mathbb{R}$; $\text{range} =]0, \infty[$

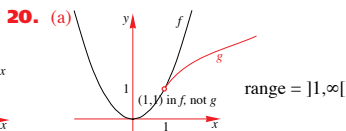
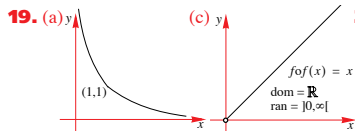

(b) $\text{gof}:]1, \infty[\rightarrow \mathbb{R}$, where $\text{gof}(x) = x$

(d) $\text{fog}^*:]1, \infty[\rightarrow \mathbb{R}$, where $\text{gof}(x) = x$

21. $d_f = \mathbb{R} \setminus \left\{ \frac{a}{c} \right\}$, $r_f = \mathbb{R} \setminus \left\{ \frac{a}{c} \right\}$, $r_f \subseteq d_f$, $\text{fof}(x) = x$

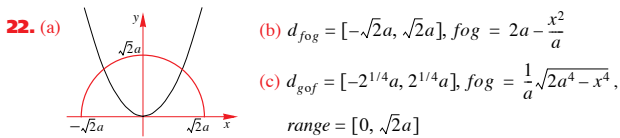

EXERCISE 5.4.2

1. (a) $\frac{1}{2}(x-1)$, $x \in \mathbb{R}$ (b) $\sqrt[3]{x}$, $x \in \mathbb{R}$ (c) $3(x+3)$, $x \in \mathbb{R}$ (d) $\frac{5}{2}(x-2)$, $x \in \mathbb{R}$ (e) $x^2 - 1$, $x > 0$

(f) $(x-1)^2$, $x \geq 1$ (g) $\frac{1}{x} - 1$, $x > 0$ (h) $\frac{1}{(x+1)^2}$, $x > -1$

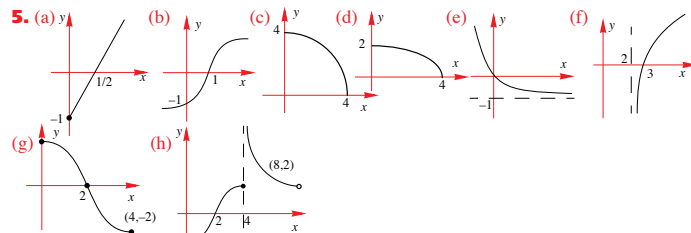
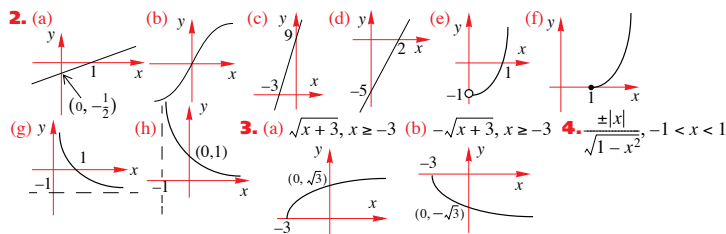

6. (a) $f^{-1}(x) = \log_3(x-1)$, $x > 1$ (b) $f^{-1}(x) = \log_2(x+5)$, $x > -5$

(c) $f^{-1}(x) = \frac{1}{2}(\log_3 x - 1)$, $x > 0$ (d) $g^{-1}(x) = 1 + \log_{10}(3-x)$, $x < 3$

(e) $h^{-1}(x) = \log_3\left(1 + \frac{2}{x}\right)$, $x \in \mathbb{R} \setminus [-2, 0]$ (f) $g^{-1}(x) = \log_2\left(\frac{1}{x+1}\right)$, $x > -1$

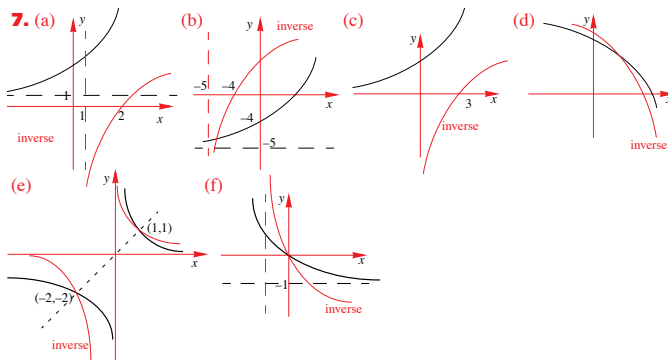

8. (a) $f^{-1}(x) = 2^x - 1$, $x \in \mathbb{R}$ (b) $f^{-1}(x) = \frac{1}{2} \cdot 10^x$, $x \in \mathbb{R}$ (c) $h^{-1}(x) = 2^{1-x}$, $x \in \mathbb{R}$

(d) $g^{-1}(x) = 3^{x+1} + 1$, $x \in \mathbb{R}$ (e) $h^{-1}(x) = 5^{x/2} + 5$, $x \in \mathbb{R}$ (f) $f^{-1}(x) = 1 - 10^{3(2-x)}$, $x \in \mathbb{R}$

9. $f^{-1}(x) = -1 + \sqrt{x+1}$, $x > -1$ **10.** (a) $f^{-1}(x) = a - x$ (b) $f^{-1}(x) = \frac{2}{x-a} + a$

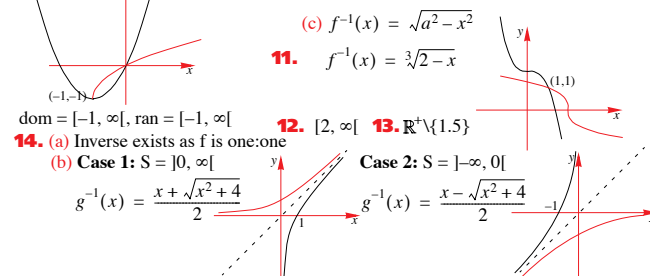

15. $f^{-1}(x) = a(x^2 + 1), x \geq 0$  $\{x: f(x) = f^{-1}(x)\} = \emptyset$

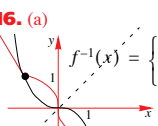
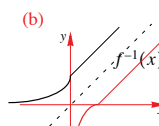
16. (a) $f^{-1}(x) = \begin{cases} -(2x+1), & x < -1 \\ -\sqrt[3]{x}, & x \geq -1 \end{cases}$  (b) $f^{-1}(x) = \begin{cases} \ln(x)-1, & 0 < x \leq e \\ x-e, & x > e \end{cases}$ 

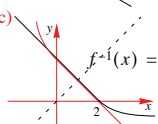
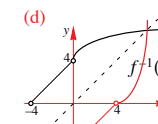
(c) $f^{-1}(x) = \begin{cases} 1 + e^{-x}, & x < 0 \\ 2 - x, & x \geq 0 \end{cases}$  (d) $f^{-1}(x) = \begin{cases} (x-4)^2, & x > 4 \\ x-4, & 0 < x < 4 \end{cases}$ 

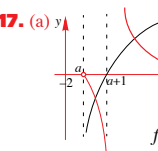
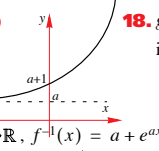
17. (a)  (b) 

18. $g \circ f$ exists as $r_f \subseteq d_g$. It is one:one so the inverse exists:

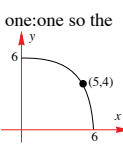
$f^{-1}: \mathbb{R} \rightarrow \mathbb{R}, f^{-1}(x) = a + e^{ax}$ 

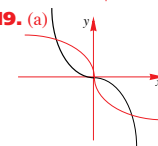
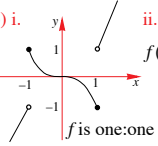
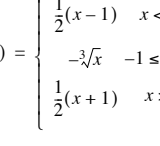
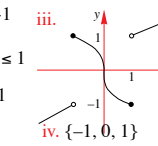
19. (a)  (b) i.  ii.  iii. 

$f(x) = \begin{cases} \frac{1}{2}(x-1) & x < -1 \\ -\sqrt[3]{x} & -1 \leq x \leq 1 \\ \frac{1}{2}(x+1) & x > 1 \end{cases}$

iv. $\{-1, 0, 1\}$

20. (a) i. $tom(x) = e^{\sqrt{x}}, x \geq 0$ ii. $mot(x) = \sqrt{e^x}, x \in \mathbb{R}$ (b) i. $(tom)^{-1}(x) = (\ln(x))^2, x > 1$

ii. $(mot)^{-1}(x) = \ln x^2, x > 0$ (c) i. & ii. neither exist

(d) Adjusting domains so that the functions in (c) exist, we have: $t^{-1}om^{-1}(x) = (mot)^{-1}(x)$ & $m^{-1}ot^{-1}(x) = (tom)^{-1}(x)$

(e) Yes as rules of composition OK.

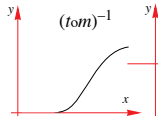
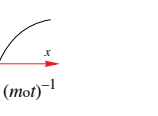

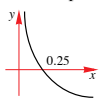
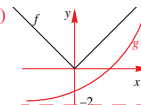
21. (a) 1 (b)  0.206 22. (a) 

(b) $f \circ g$ exists but is not one:one

(c) i. $B = [\ln 2, \infty[$

ii. $(f \circ g)^{-1}: [0, \infty[\rightarrow \mathbb{R}$ where, $(f \circ g)^{-1}(x) = \ln(x+2)$ iii.

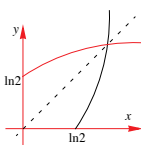

EXERCISE 6.1

1. (a) $y = (x-4)^2$ (b) $y = (x+2)^2$ (c) $y = x^2 + 5$ (d) $(x-2)^2 + y = 2$ (e) $x^2 + y = 4$

(f) $x^2 + y = 0$ (g) $y = \frac{8}{x-4}, x \neq 4$ (h) $y = \frac{8}{x} - 1, x \neq 0$ (i) $(x+1)^2 + y^2 = 4$

(j) $y^2 = \frac{9}{x-3}, x \neq 3$ (k) $(y+3)^2 = \frac{9}{x}, x \neq 0$ (l) $x + y^2 = 8$

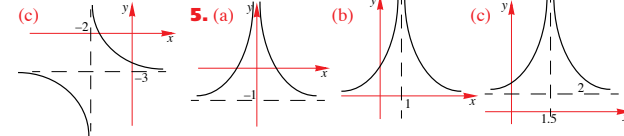
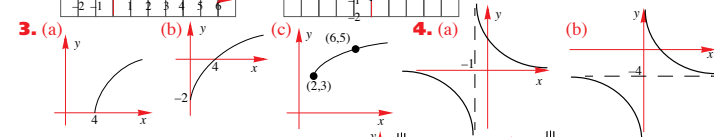
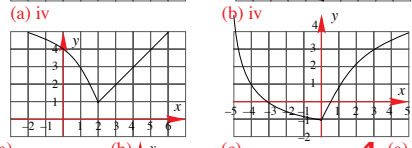
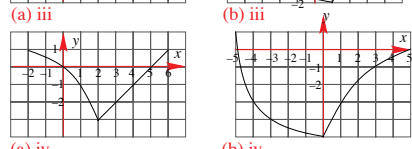
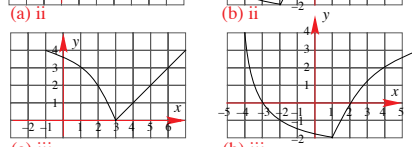
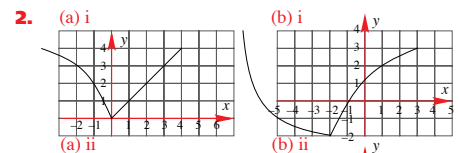

6. First function in black, second function in red

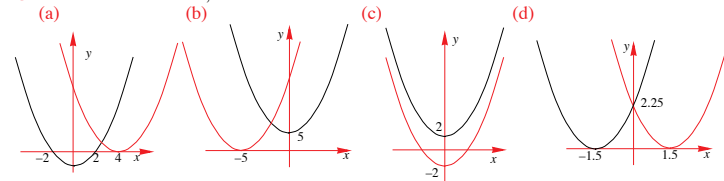

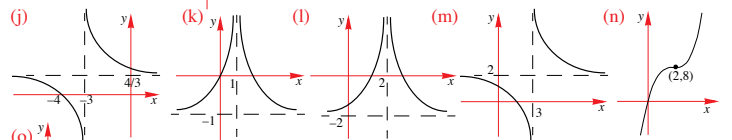
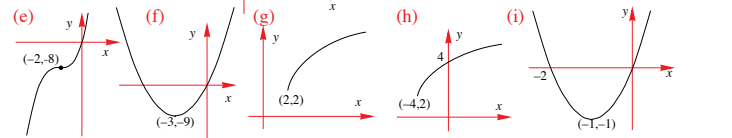
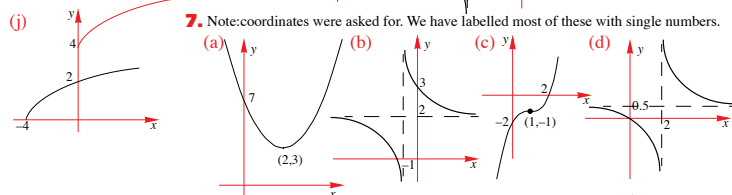
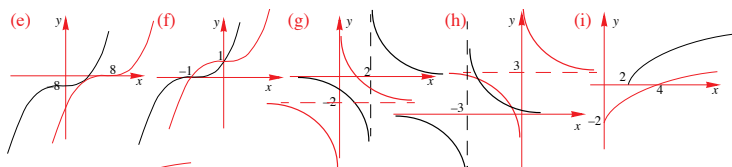

8. (a) $\begin{pmatrix} 0 \\ 4 \end{pmatrix}$ (b) $\begin{pmatrix} 0 \\ -2 \end{pmatrix}$ (c) $\begin{pmatrix} -1 \\ 0 \end{pmatrix}$ (d) $\begin{pmatrix} 2 \\ 0 \end{pmatrix}$ (e) $\begin{pmatrix} -2 \\ 0 \end{pmatrix}$ (f) $\begin{pmatrix} 0 \\ -4 \end{pmatrix}$ (g) $\begin{pmatrix} 2 \\ -2 \end{pmatrix}$ (h) $\begin{pmatrix} -2 \\ 3 \end{pmatrix}$

(i) $\begin{pmatrix} 4 \\ 2 \end{pmatrix}$ (j) $\begin{pmatrix} 2 \\ 3 \end{pmatrix}$ (k) $\begin{pmatrix} 3 \\ -1 \end{pmatrix}$ (l) $\begin{pmatrix} -k \\ h \end{pmatrix}$ (m) $\begin{pmatrix} -2 \\ 4 \end{pmatrix}$ (n) $\begin{pmatrix} 1 \\ -1 \end{pmatrix}$ (o) $\begin{pmatrix} -1 \\ 2 \end{pmatrix}$

9. (a) $g(x) = f(x-1) + 1$ (b) $g(x) = f(x+2) - 4$ (c) $g(x) = f(x-2)$
 (d) $g(x) = f(x-1) + 1$ (e) $g(x) = f(x-1) + 3$

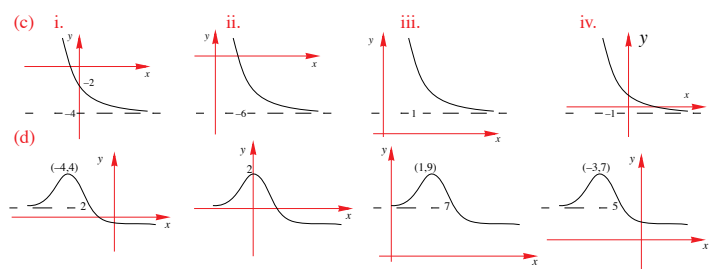
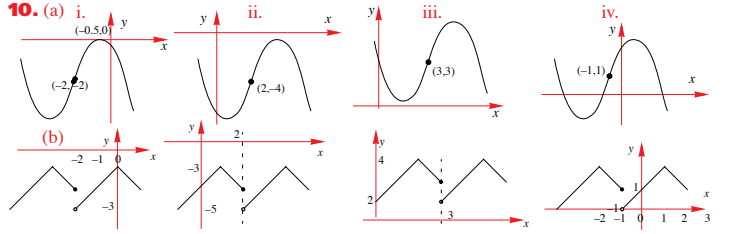

11. $y = \begin{cases} f(x+2) + 2, & -3 \leq x \leq -1 \\ f(x+4) + 2, & -5 \leq x \leq -3 \end{cases}$

EXERCISE 6.2

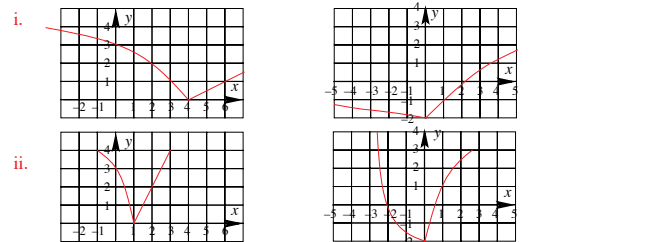
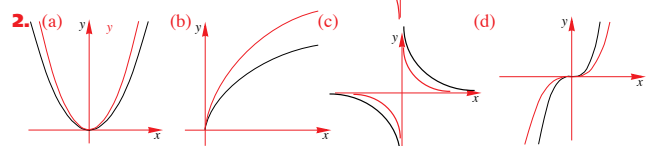
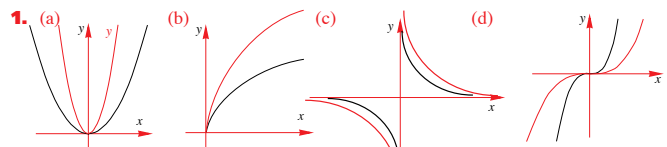

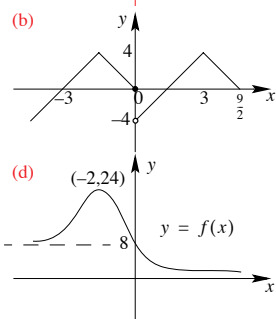
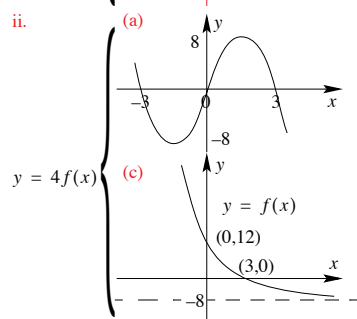
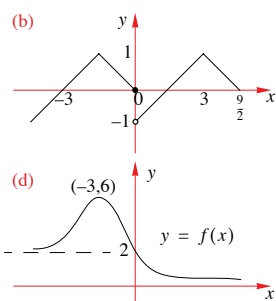
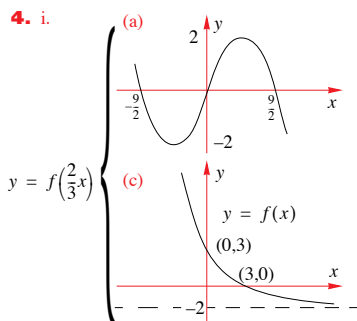
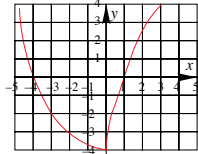
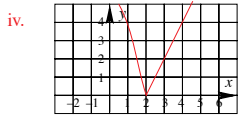
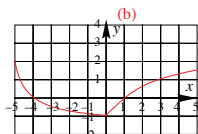
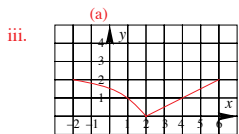

5. (a) $f(x) = |x|$ $y = f(2x) + 1$ (b) $f(x) = x^2$ $y = \frac{1}{2}f(x-2) - 3$

(c) $f(x) = \frac{1}{x}$ $y = \frac{1}{2}f(x - \frac{1}{2})$ (d) $f(x) = x^3$ $y = 27f(x - \frac{2}{3})$

(e) $f(x) = x^4$ $y = 128f(x - \frac{1}{2}) - 2$ (f) $f(x) = \sqrt{x}$ $y = \sqrt{2}f(x) + 2$

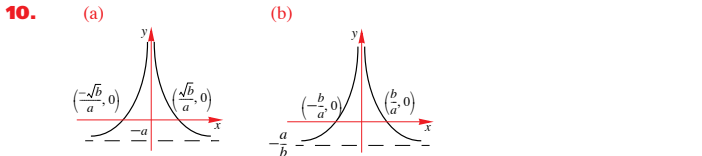
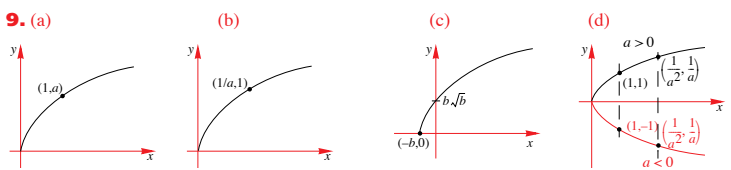
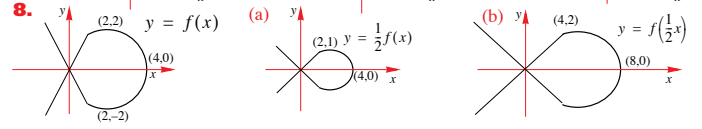
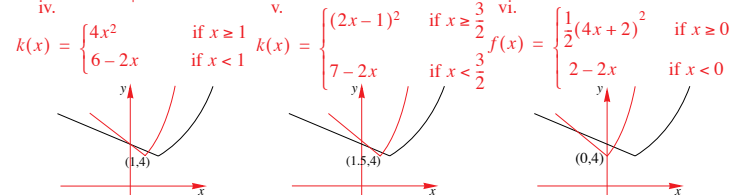
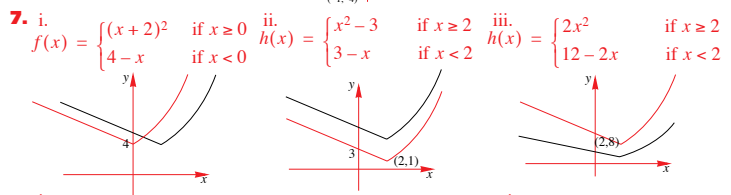
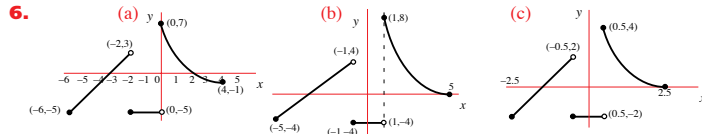

EXERCISE 6.3

1. i.

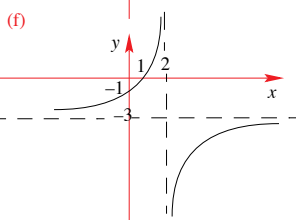
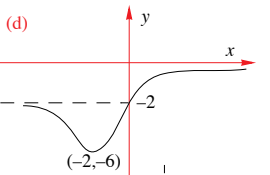
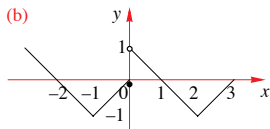
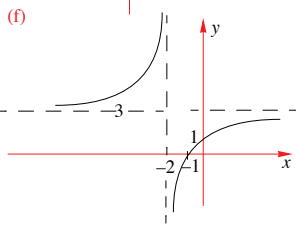
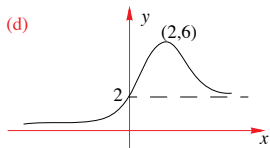
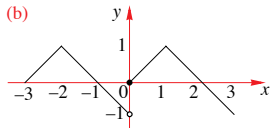
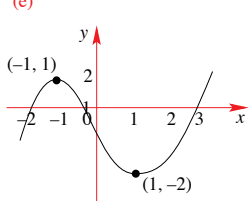
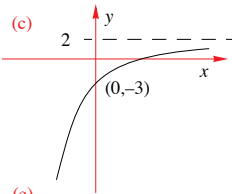
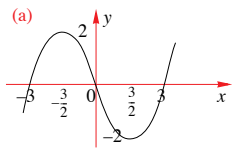
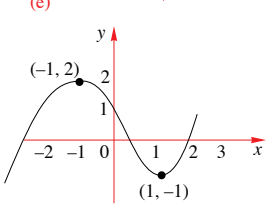
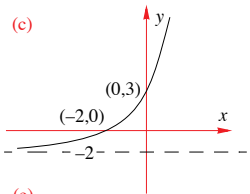
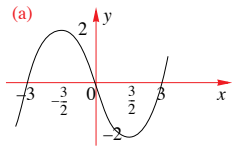

ii.

2. (a) $y = -f(x)$ (b) $y = f(-x)$ (c) $y = f(x+1)$ (d) $y = f(2x)$ (e) $y = 2f(x)$
 3. (a) (b) (c) (d)

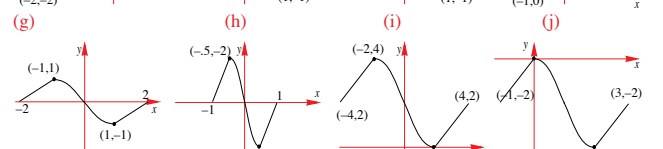
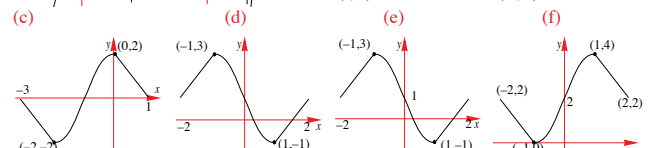
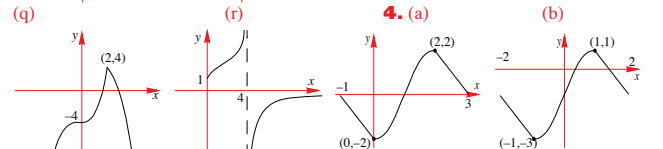
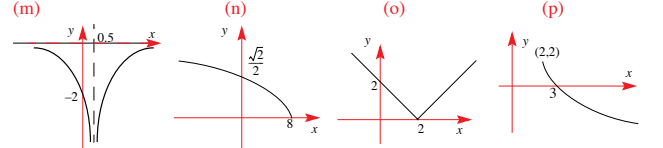
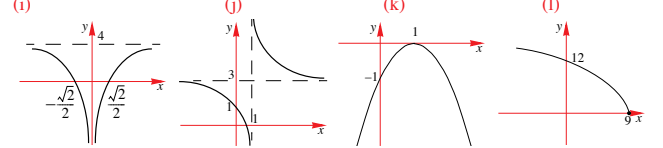
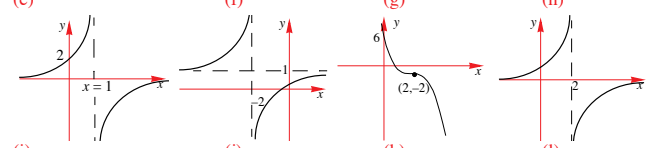
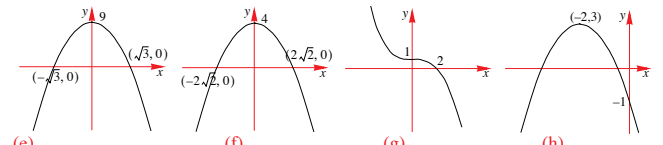

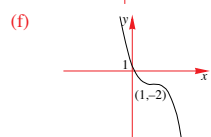
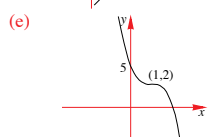
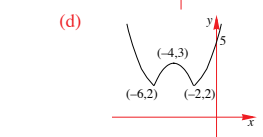
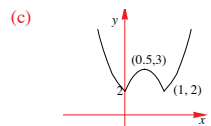
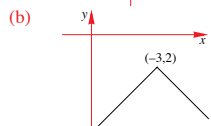
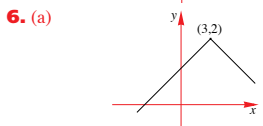
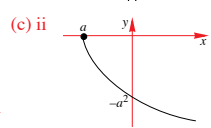
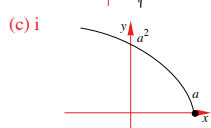
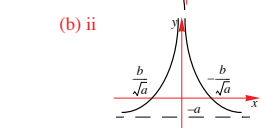
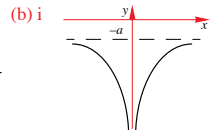
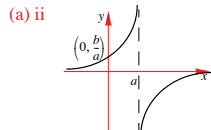
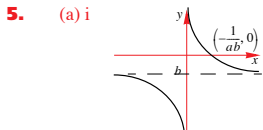

EXERCISE 6.4

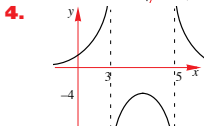
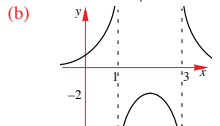
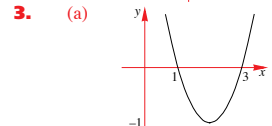
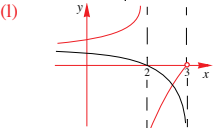
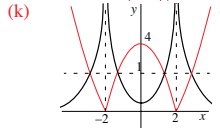
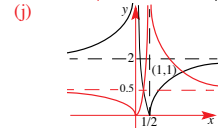
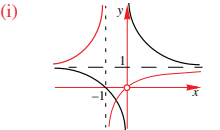
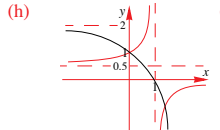
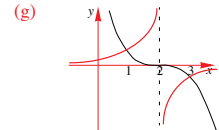
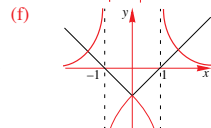
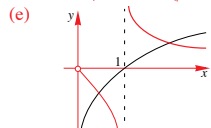
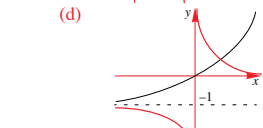
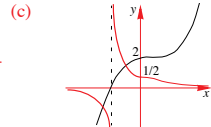
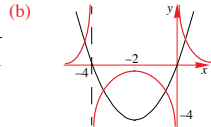
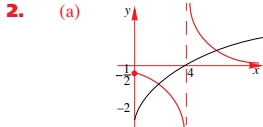
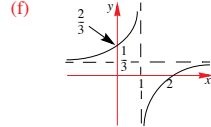
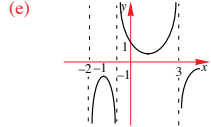
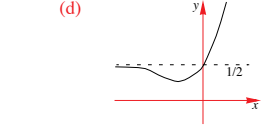
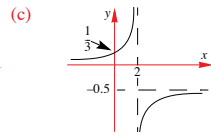
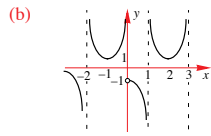
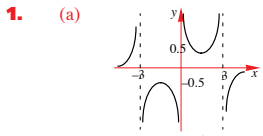

EXERCISE 6.5

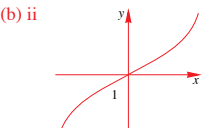
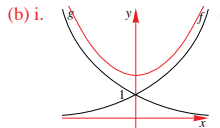
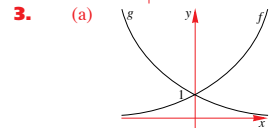
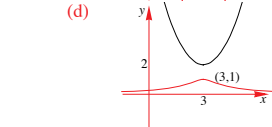
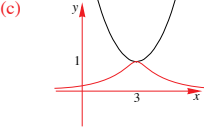
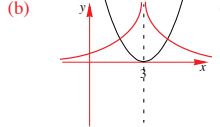
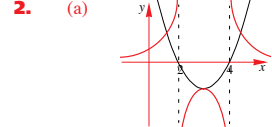
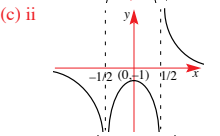
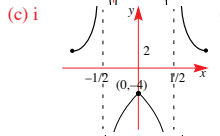
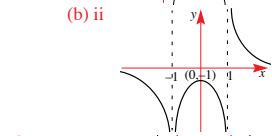
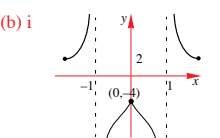
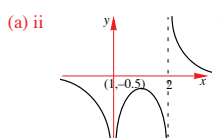
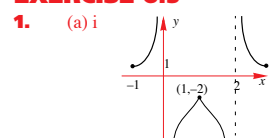

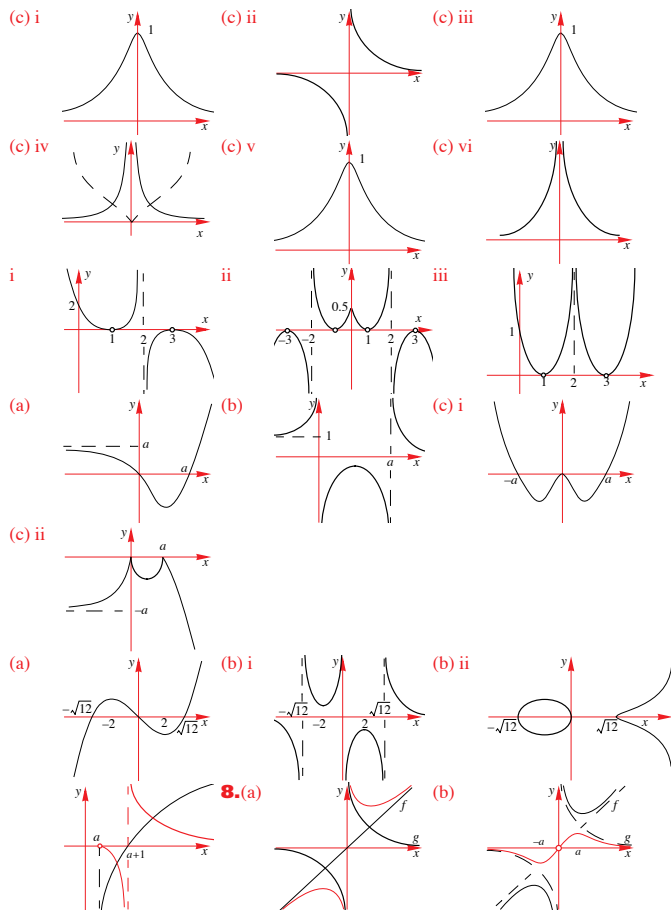

EXERCISE 7.1.1

1. (a) $\frac{27y^{15}}{8x^3}$ (b) $\frac{91}{216a^6}$ (c) $2^n + 2$ (d) $\frac{8x^{11}}{27y^2}$ (e) $\frac{3x^2y^2}{8}$ (f) $3^{n+1} + 3$ (g) $4^{n+1} - 4$
 (h) $2(4^{n+1} - 4)$ (i) $\frac{1-b^6}{16b^4}$ 2. (a) 64 (b) $(\frac{2}{3})^x$ (c) $22y+1$ (d) $\frac{1}{b^{2x}}$ (e) $(\frac{y}{2})^6$ (f) $(\frac{9}{2})^{n+2}$ 3. (a) $\frac{z^2}{xy}$
 (b) $37n-2$ (c) $5n+1$ (d) 9 (e) $26n+1$ (f) $21-3n$ (g) x^2+4n-n^2 (h) x^{3n^2+n+1} (i) 27 4. $\frac{y^{2m-2}}{x^m}$
 5. (a) -81 (b) $-\frac{9x^8}{8y^4}$ (c) $y-x$ (d) $\frac{2x+1}{x+1}$ (e) -1 (f) -b 6. (a) $\frac{1}{x^2y^2}$ (b) $\frac{1}{x^4}$ (c) $-\frac{1}{x(x+h)}$

ANSWERS - 28

- (d) $\frac{1}{x-1}$ (e) $\frac{1}{(x+1)(x-1)^5}$ (f) $\frac{1}{x^2}$ 7. (a) $118 \times 5^{n-2}$ (b) 1 (c) $\frac{b^7}{a^4}$ (d) a^{mn} (e) $\frac{p+q}{pq}$ (f) $\frac{2\sqrt{a}}{a-1}$
 (g) $\frac{7}{8}$ (h) $a^{7/8}$ 8. (a) $x^{11/12}$ (b) $2a^{3n-2}b^{2n-2}$ (c) 2^n (d) $-\frac{7^{m-n}}{8}$ (e) $\frac{6 \times 5^n}{5^n+5}$ (f) $x+1$

EXERCISE 7.1.2

1. (a) 2 (b) -2 (c) $\frac{2}{3}$ (d) 5 (e) 6 (f) -2.5 (g) 2 (h) 1.25 (i) $\frac{1}{3}$ 2. (a) -6 (b) $-\frac{2}{3}$ (c) -3 (d) 1.5 (e) 0.25
 (f) 0.25 (g) $-\frac{1}{8}$ (h) $-\frac{11}{4}$ (i) -1.25

EXERCISE 7.1.3

1. (a) 3.5 (b) 3.5 (c) -3 (d) 1.5 (e) 3.5 (f) 1.5 (g) 1.8 (h) $-\frac{4}{7}$ (i) 0 2. (a) -0.75 (b) -1.4 (c) 0, 1
 (d) 3, 4 (e) -1, 4 (f) 0, 2 3. (a) -1, 1, 2 (b) -3, 1, 3, 4 (c) $\frac{4}{3}, \frac{5}{3}, 2$ (d) -1, 1, 2 (e) 3, 7, $-\frac{1 \pm \sqrt{233}}{2}, \frac{1}{3}$

EXERCISE 7.1.4

1. (a) i. 5.32 ii. 9.99 iii. 2.58 (b) i. 2.26 ii. 3.99 iii. 5.66 (c) i. 3.32 ii. -4.32 iii. -6.32 (d) i. -1.43
 ii. 1.68 iii. -2.86 2. (a) 0 (b) 0.54 (c) -0.21 (d) -0.75, 0 (e) 1.13 (f) 0, 0.16

EXERCISE 7.1.5

1. (a) 2 (b) -1 (c) 0.5 (d) 0.5 2. (a) 1 (b) 0.6 (c) 0 3. (a) 0 (b) $\frac{2}{3}$ 4. (a) -1, 2 (b) -2, 3 (c) -1
 (d) -6, 1 (e) 0, 1 (f) 1 5. (a) 1.3863 (b) 2.1972 (c) 3.2189 (d) 0 6. (a) 0.4236 (b) 0.4055
 (c) 0.3054 (d) -0.4176 7. (a) 0 (b) -0.6733 (c) 0 9. 36 10. $a = \sqrt{2}e, k = \ln(\sqrt{2})$

EXERCISE 7.2

1. (a) 1000 (b) 1516 (c) 2000 (d) 10 days 2. (a) 0.0013 (b) 2.061 kg (c) 231.56 yrs
 (d) 3. (a) 0.01398 (b) 52.53% (c) 51.53m (d) 21.53m

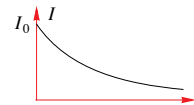
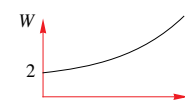

4. (a) i. 157 ii. 165 iii. 191 (b) 14.2 yrs (c) 20.1 yrs (d)

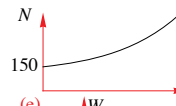

5. (a) 50 (b) 0.0222 (c) 17.99 kg (d)

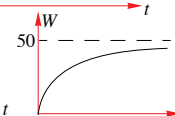
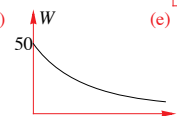

ANSWERS - 29

6. (a) 15 000°C (b) i. 11 900°C ii. 1500°C (c) 3.01 million yrs (d)

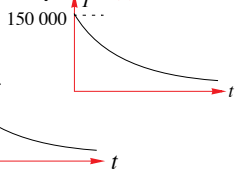

7. (a) 0.0151 (b) 12.50gm (c) 20 years (d)

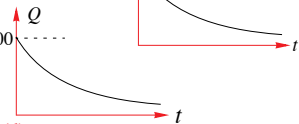

8. (a) \$2 million (b) \$1.589 mil (c) 30.1 years (d)

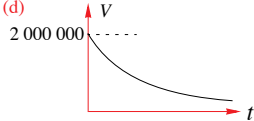

9. (b) 0.01761 (c) 199 230 (d) 22.6 years

10. (a) 20 cm² (b) 19.72 cm² (c) 100 days (d) 332 days

11. (a) 1 (b) i. 512170 ii. 517217 (c) 54.1 early 2014

12. (a) i. \$933.55 ii. \$935.50 (b) 11.95 years (c)

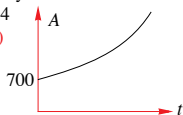

13. (a) 99 (b) $99 \times 2^{0.1394t}$ (c) 684

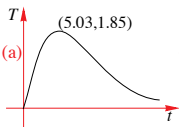

14. (a) (b) 38.85°C at ~midnight

15. (a) 19 (b) 2.63 (c) 100

16. (a) 18 cm (b) 4 cm (c) 1.28 m (d) 36 m (e) i. 21.7yr ii. 27.6yr iii. 34.5yr (f) 36 (g)

17. (a) 5 mg/min (b) 13.51 min (c) i. 2.1, ii. 13.9 iii. 68 min

- (d) 19.6 mg (e) (f) No

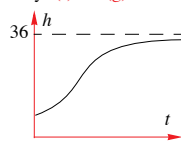
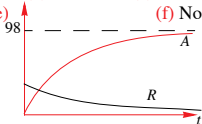

18. (a) i. \$499 ii. \$496 iii. \$467 (c) 15537 (d) i. \$499k ii. \$2.48mil iii. \$4.67mil (f) 12358

- (g) \$5.14mil (b), (e)

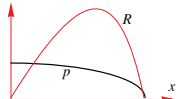

EXERCISE 7.3

1. (a) 2 (b) 2 (c) 5 (d) 3 (e) -3 (f) -2 (g) 0 (h) 0 (i) -1 (j) -2 (k) 0.5 (l) -2 2. (a) $\log_{10} 10000 = 4$

- (b) $\log_{10} 0.001 = -3$ (c) $\log_{10}(x+1) = y$ (d) $\log_{10} p = 7$ (e) $\log_2(x-1) = y$

- (f) $\log_2(y-2) = 4x$ 3. (a) $2^y = x$ (b) $b^x = y$ (c) $b^{ax} = t$ (d) $10^{x^2} = z$ (e) $10^{1-x} = y$

- (f) $2^y = ax - b$ 4. (a) 16 (b) 2 (c) 2 (d) 9 (e) $4\sqrt{2}$ (f) 125 (g) 4 (h) 9 (i) $\sqrt[3]{\frac{1}{3}}$ (j) 21 (k) 3 (l) 13

5. (a) 54.5982 (b) 1.3863 (c) 1.6487 (d) 7.3891 (e) 1.6487 (f) 0.3679 (g) 52.5982 (h) 4.7183

- (i) 0.6065

EXERCISE 7.4

1. (a) 5 (b) 2 (c) 2 (d) 1 (e) 2 (f) 1 2. (a) $\log a = \log b + \log c$ (b) $\log a = 2\log b + \log c$

- (c) $\log a = -2\log c$ (d) $\log a = \log b + 0.5\log c$ (e) $\log a = 3\log b + 4\log c$

- (f) $\log a = 2\log b - 0.5\log c$ 3. (a) 0.18 (b) 0.045 (c) -0.09 4. (a) $x = yz$ (b) $y = x^2$

- (c) $y = \frac{x+1}{x}$ (d) $x = 2^{y+1}$ (e) $y = \sqrt{x}$ (f) $y^2 = (x+1)^3$ 5. (a) $\frac{1}{2}$ (b) $\frac{1}{2}$ (c) $\frac{17}{15}$ (d) $\frac{3}{2}$ (e) $\frac{1}{3}$

- (f) no real sol'n (g) 3,7 (h) $\frac{\sqrt{33}-1}{2}$ (i) 4 (j) $\sqrt{10}+3$ (k) $\frac{64}{63}$ (l) $\frac{2}{15}$ 6. (a) $\log_3 2wx$ (b) $\log \frac{x}{47y}$

- (c) $\log_a [x^2(x+1)^3]$ (d) $\log_a \left[\frac{(x^5)(x+1)^3}{\sqrt{2x-3}} \right]$ (e) $\log_{10} \left(\frac{y^2}{x} \right)$ (f) $\log_2 \left(\frac{y}{x} \right)$ 7. (a) 1 (b) -2 (c) 3 (d) 9

- (e) 2 (f) 9 8. (a) 1.4 (b) $1, 3 \pm \sqrt{5}$ (c) $1, 4\sqrt[3]{4}$ (d) $1, 5 \pm \sqrt[3]{5}$ 9. (a) $\frac{\log 14}{\log 2} = 3.81$ (b) $\frac{\log 8}{\log 10} = 0.90$

- (c) $\frac{\log 125}{\log 3} = 4.39$ (d) $\frac{1}{\log 2} \times \log \left(\frac{11}{3} \right) - 2 = -0.13$ (e) $\frac{\log 10 - \log 3}{4\log 3} = 0.27$ (f) 5.11

- (g) $\frac{-\log 2}{2\log 10} = -0.15$ (h) 7.37 (i) 0.93 (j) no real solution (k) $\frac{\log 3}{\log 2} - 2 = -0.42$

- (l) $\frac{\log 1.5}{\log 3} = 0.37$ 10. (a) 0.5,4 (b) 3 (c) -1,4 (d) $10, 10^{10}$ (e) 5 (f) 3 11. (a) (4, $\log_4 11$)

- (b) (100,10) (c) (2,1) 12. (a) $y = xz$ (b) $y = x^3$ (c) $x = e^{y-1}$ 13. (a) $\frac{1}{e^4-1}$ (b) $\frac{1}{3}$ (c) $\frac{\sqrt{5}-1}{2}$

- (d) \emptyset 14. (a) $\ln 21 = 3.0445$ (b) $\ln 10 = 2.3026$ (c) $-\ln 7 = -1.9459$ (d) $\ln 2 = 0.6931$

- (e) $\ln 3 = 1.0986$ (f) $2\ln \left(\frac{14}{9} \right) = 0.8837$ (g) $e^3 = 20.0855$ (h) $\frac{1}{3}e^2 = 2.4630$

- (i) $\pm\sqrt{e^9} = \pm 90.0171$ (j) \emptyset (k) $e^2 - 4 = 3.3891$ (l) $\sqrt[3]{e^9} = 20.0855$ 15. (a) 0, $\ln 2$ (b) $\ln 5$

- (c) $\ln 2, \ln 3$ (d) 0 (e) 0, $\ln 5$ (f) $\ln 10$ 16. (a) 4.5222 (b) 0.2643 (c) 0.02619 (d) -1.03219

- (e) -1.2925, 0.6610 (f) 0.18928 (g) 0.25, 2 (h) 1 (i) 121.5 (j) 2

EXERCISE 7.5

1. (a) 10 (b) 30 (c) 40 2. (a) 31.64 kg (b) 1.65 (c) $W = 2.4 \times 10^{0.8h}$

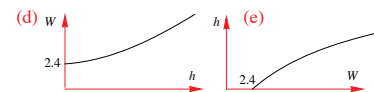

3. (a) 4.75 (b) $L = L_0 \times 10^{\left(\frac{6-m}{2.5}\right)}$

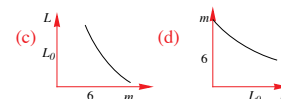

4. (a) [0,1] (b) i. 2.22 ii. 1.11 iii. 0.74 yrs (c) As c increases, reliability reduces.

- (d) $x = 1 - 10^{-ct}$ (e)

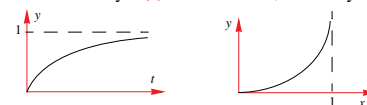

5. (a) $I = \frac{a}{n^k}$ 6. (a) 0.10 (b) $\lambda = \lambda_0 \times 10^{-kx}$ (c) 16.82% (d) $k = -\frac{1}{x} \log\left(\frac{\lambda}{\lambda_0}\right)$

EXERCISE 8.1.1

1. i. (b) 4 (c) $t_n = 4n - 2$ ii. (b) -3 (c) $t_n = -3n + 23$ iii. (b) -5 (c) $t_n = -5n + 6$ iv. (b) 0.5
 (c) $t_n = 0.5n$ v. (b) 2 (c) $t_n = y + 2n - 1$ vi. (b) -2 (c) $t_n = x - 2n + 4$ 2. -28 3. 9, 17 4. -43
 5. 7 6. 7 7. -5 8. 0 9. (a) 41 (b) 31st 10. 2, $\sqrt{3}$ 11. (a) i. 2 ii. -3 (b) i. 4 ii. 11
 12. $x - 8y$ 13. $t_n = 5 + \frac{10}{3}(n - 1)$ 14. (a) -1 (b) 0

EXERCISE 8.1.2

1. (a) 145 (b) 300 (c) -170 2. (a) -18 (b) 690 (c) 70.4 3. (a) -105 (b) 507 (c) 224 4. (a) 126
 (b) 3900 (c) 14th week 5. 855 6. (a) 420 (b) -210 7. $a = 9, b = 7$

EXERCISE 8.1.3

1. 123 2. $-3, -0.5, 2, 4.5, 7, 9.5, 12$ 3. 3.25 4. $a = 3, d = -0.05$ 5. 10 000 6. 330 7. -20
 8. 328 9. \$725, 37wks 10. i. \$55 ii. 2750 11. (a) (i) 8m (ii) 40m (b) 84m
 (c) Dist = $2n^2 - 2n = 2n(n - 1)$ (d) 8 (e) 26 players, 1300m 12. (a) 5050 (b) 10200 (c) 4233
 13. (a) 145 (b) 390 (c) -1845 14. (b) $3n - 2$

EXERCISE 8.2.1

1. (a) $r = 2, u_5 = 48, u_n = 3 \times 2^{n-1}$ (b) $r = \frac{1}{3}, u_5 = \frac{1}{27}, u_n = 3 \times \left(\frac{1}{3}\right)^{n-1}$
 (c) $r = \frac{1}{5}, u_5 = \frac{2}{625}, u_n = 2 \times \left(\frac{1}{5}\right)^{n-1}$ (d) $r = -4, u_5 = -256, u_n = -1 \times (-4)^{n-1}$
 (e) $r = \frac{1}{b}, u_5 = \frac{a}{b^5}, u_n = ab \times \left(\frac{1}{b}\right)^{n-1}$ (f) $r = \frac{b}{a}, u_5 = \frac{b^4}{a^2}, u_n = a^2 \times \left(\frac{b}{a}\right)^{n-1}$ 2. (a) ± 12
 (b) $\frac{\pm\sqrt{5}}{2}$ 3. (a) ± 96 (b) 15th 4. (a) $u_n = 10 \times \left(\frac{5}{6}\right)^{n-1}$ (b) $\frac{15625}{3888} \approx 4.02$ (c) $n = 5$ (4 times)
 5. $-2, \frac{4}{3}$ 6. (a) i. \$4096 ii. \$2097.15 (b) 6.2 yrs 7. $\left(u_n = \frac{1000}{169} \times \left(\frac{12}{5}\right)^{n-1}\right), \frac{1990656}{4225} \approx 471.16$
 8. 2.5, 5, 10 or 10, 5, 2.5 9. 53757 10. 108 952 11. (a) \$56 156 (b) \$299 284

EXERCISE 8.2.2

1. (a) 3 (b) $\frac{1}{3}$ (c) -1 (d) $-\frac{1}{3}$ (e) 1.25 (f) $-\frac{2}{3}$ 2. (a) 216513 (b) 1.6384×10^{-10} (c) $\frac{256}{729}$
 (d) $\frac{729}{2401}$ (e) $-\frac{81}{1024}$ 3. (a) 11; 354292 (b) 7; 473 (c) 8; 90.90909 (d) 8; 172.778 (e) 5; 2.256
 (f) 13; 111.1111111111 4. (a) $\frac{127}{128}$ (b) $\frac{63}{8}$ (c) $\frac{130}{81}$ (d) 60 (e) $\frac{63}{64}$ 5. 4; 118096 6. \$2109.50
 7. 9.28cm 8. (a) $V_n = V_0 \times 0.7^n$ (b) 7 9. 54 10. 53.5gms; 50 weeks. 11. 7 12. 9
 13. $-0.5, -0.7797$ 14. $r = 5, 1.8 \times 10^{10}$ 15. \$8407.35
 16. 1.8×10^{19} or about 200 billion tonnes.

EXERCISE 8.2.3

1. Term 9 AP = 180, GP = 256. Sum to 11 terms AP = 1650, GP = 2047. 2. 18. 3. 12 4. 7, 12
 5. 8 weeks (Ken \$220 & Bo-Youn \$255) 6. (a) week 8 (b) week 12 7. (a) 1.618 (b) 121379
 [~ 121400 , depends on rounding errors]

EXERCISE 8.2.4

1. (i) $\frac{81}{2}$ (ii) $\frac{10}{13}$ (iii) 5000 (iv) $\frac{30}{11}$ 2. $23\frac{23}{99}$ 3. 6667 fish. [Nb: $t_{43} < 1$. If we use $n = 43$ then
 ans is 6660 fish]; 20 000 fish. Overfishing means that fewer fish are caught in the long run. [An
 alternate estimate for the total catch is 1665 fish.] 4. 27 5. 48, 12, 3 or 16, 12, 9 6. (a) $\frac{11}{30}$ (b) $\frac{37}{99}$
 (c) $\frac{191}{90}$ 7. 128 cm 8. $\frac{121}{9}$ 9. $2 + \frac{4}{3}\sqrt{3}$ 10. $\frac{1 - (-t)^n}{1 + t} \frac{1}{1 + t}$ 11. $\frac{1 - (-t^2)^n}{1 + t^2} \frac{1}{1 + t^2}$

EXERCISE 8.2.5

1. 3, -0.2 2. $\frac{2560}{93}$ 3. $\frac{10}{3}$ 4. (a) $\frac{43}{18}$ (b) $\frac{458}{99}$ (c) $\frac{413}{990}$ 5. 9900 6. 3275 7. 3
 8. $t_n = 6n - 14$ 9. 6 10. $-\frac{1}{6}$ 11. i. 12 ii. 26 12. 9, 12 13. ± 2 14. (5, 5, 5), (5, -10 , 20)
 15. (a) 2, 7 (b) 2, 5, 8 (c) $3n - 1$ 16. (a) 5 (b) 2 m

EXERCISE 8.3

1. \$2773.08 2. \$4377.63 3. \$1781.94 4. \$12216 5. \$35816.95 6. \$40349.37 7. \$64006.80
 8. \$276971.93, \$281325.41 9. \$63762.25 10. \$98.62, \$9467.14, interest \$4467.14.
 Flat interest = \$6000 11. \$134.41, \$3790.44, 0.602% /month (or 7.22% p.a)

EXERCISE 9.1

	a cm	b cm	c cm	A	B	C
1	3.8	4.1	1.6	67°	90°	23°
2	81.5	98.3	55.0	56°	90°	34°
3	32.7	47.1	33.9	44°	90°	46°
4	1.61	30.7	30.7	3°	90°	87°
5	2.3	2.74	1.49	57°	90°	33°
6	48.5	77	59.8	39°	90°	51°
7	44.4	81.6	68.4	33°	90°	57°
8	2.93	13.0	12.7	13°	90°	77°
9	74.4	94.4	58.1	52°	90°	38°
10	71.8	96.5	64.6	48°	90°	42°
11	23.3	34.1	24.9	43°	90°	47°
12	43.1	43.2	2.3	87°	90°	3°
13	71.5	80.2	36.4	63°	90°	27°
14	33.5	34.1	6.5	79°	90°	11°
15	6.1	7.2	3.82	58°	90°	32°
16	29.1	30	7.3	76°	90°	14°
17	29.0	29.1	2.0	86°	90°	4°
18	34.5	88.2	81.2	23°	90°	67°
19	24.0	29.7	17.5	54°	90°	36°
20	41.2	46.2	21.0	63°	90°	27°
21	59.6	72.9	41.8	55°	90°	35°
22	5.43	6.8	4.09	53°	90°	37°

- 23 13.0 19.8 14.9 41° 90° 49°
 24 14.0 21.3 16.1 41° 90° 49°
 25 82.4 88.9 33.3 68° 90° 22°
2. (a) $2\sqrt{3}$ (b) $5(1 + \sqrt{3})$ (c) 4 (d) $2(1 + \sqrt{3})$ (e) $\frac{4}{3}(3 + \sqrt{3})$ (f) $\sqrt{106} - 5$ 4. (a) $25(1 + \sqrt{3})$
 (b) $\frac{40\sqrt{3}}{3}$

EXERCISE 9.2

1. (a) i. 030°T ii. 330°T iii. 195°T iv. 200°T (b) i. $\text{N}25^\circ\text{E}$ ii. S iii. $\text{S}40^\circ\text{W}$ iv. $\text{N}10^\circ\text{W}$
 2. 37.49m 3. 18.94m 4. $37^\circ 18'$ 5. $\frac{26}{9}$ m/s 6. $\text{N}58^\circ 33'\text{W}$, 37.23 km 7. 199.82 m 8. 10.58 m
 9. 72.25 m 10. 25.39 km 11. 15.76 m 12. (a) 3.01km N, 3.99km E (b) 2.87km E 0.88km S
 (c) 6.86km E 2.13km N (d) 7.19km 253°T 13. 524m

EXERCISE 9.3

1. (a) $39^\circ 48'$ (b) $64^\circ 46'$ 2. (a) 12.81 cm (b) 61.35 cm (c) $77^\circ 57'$ (d) 60.83 cm (e) $80^\circ 32'$
 3. (a) $21^\circ 48'$ (b) $42^\circ 2'$ (c) $26^\circ 34'$ 4. (a) 2274 (b) 12.7° 5. 251.29 m 6. (a) 103.5 m (b) 35.26°
 (c) 39.23° 7. (b) 53.43 (c) 155.16 m (d) 145.68 m 8. (b) 48.54 m 9. (a) $\sqrt{(b-c)^2 + h^2}$
 (b) $\tan^{-1}\left(\frac{h}{a}\right)$ (c) $\tan^{-1}\left(\frac{h}{b-c}\right)$ (d) $2(b+c)\sqrt{h^2 + a^2} + 2a\sqrt{(b-c)^2 + h^2}$ 10. 82.80 m
 11. (a) 40.61 m (b) 49.46 m 12. (a) 10.61 cm (b) $75^\circ 58'$ (c) $93^\circ 22'$ 13. (a) 1.44 m (b) $73^\circ 13'$
 (c) $62^\circ 11'$

EXERCISE 9.4

1. (a) 1999.2 cm² (b) 756.8 cm² (c) 3854.8 cm² (d) 2704.9 cm² (e) 538.0 cm² (f) 417.5 cm²
 (g) 549.4 cm² (h) 14.2 cm² (i) 516.2 cm² (j) 281.5 cm² (k) 918.8 cm² (l) 387.2 cm²
 (m) 139.0 cm² (n) 853.7 cm² (o) 314.6 cm² 2. 69345 m² 3. $100\pi - 6\sqrt{91}$ cm² 4. 17.34 cm
 5. (a) 36.77sq units (b) 14.70 sq units (c) 62.53 sq units 6. 52.16 cm² 7. $27^\circ 2'$
 8. $\frac{(b+a \times \tan\theta)^2}{2\tan\theta}$ 9. Area of $\triangle ACD = 101.78$ cm², Area of $\triangle ABC = 61.38$ cm²

EXERCISE 9.5.1

	a cm	b cm	c cm	A	B	C
1	13.3	37.1	48.2	10°	29°	141°
2	2.7	1.2	2.8	74°	25°	81°
3	11.0	0.7	11.3	60°	3°	117°
4	31.9	39.1	51.7	38°	49°	93°
5	18.5	11.4	19.5	68°	35°	77°
6	14.6	15.0	5.3	75°	84°	21°
7	26.0	7.3	26.4	79°	16°	85°
8	21.6	10.1	28.5	39°	17°	124°
9	0.8	0.2	0.8	82°	16°	82°
10	27.7	7.4	33.3	36°	9°	135°
11	16.4	20.7	14.5	52°	84°	44°
12	21.4	45.6	64.3	11°	24°	145°
13	30.9	27.7	22.6	75°	60°	45°

14	29.3	45.6	59.1	29°	49°	102°
15	9.7	9.8	7.9	65°	67°	48°
16	21.5	36.6	54.2	16°	28°	136°
17	14.8	29.3	27.2	30°	83°	67°
18	10.5	0.7	10.9	52°	3°	125°
19	11.2	6.9	17.0	25°	15°	140°
20	25.8	18.5	40.1	30°	21°	129°

EXERCISE 9.5.2

	a	b	c	A°	B°	C°	c*	B*°	C*°
1	7.40	18.10	21.06	20.00	56.78	103.22	12.95	123.22	36.78
2	13.30	19.50	31.36	14.00	20.77	145.23	6.49	159.23	6.77
3	13.50	17.00	25.90	28.00	36.24	115.76	4.12	143.76	8.24
4	10.20	17.00	25.62	15.00	25.55	139.45	7.22	154.45	10.55
5	7.40	15.20	19.55	20.00	44.63	115.37	9.02	135.37	24.63
6	10.70	14.10	21.41	26.00	35.29	118.71	3.94	144.71	9.29
7	11.50	12.60	22.94	17.00	18.68	144.32	1.16	161.32	1.68
8	8.30	13.70	18.67	24.00	42.17	113.83	6.36	137.83	18.17
9	13.70	17.80	30.28	14.00	18.32	147.68	4.27	161.68	4.32
10	13.40	17.80	26.19	28.00	38.58	113.42	5.24	141.42	10.58
11	12.10	16.80	25.63	23.00	32.85	124.15	5.30	147.15	9.85
12	12.00	14.50	24.35	21.00	25.66	133.34	2.72	154.34	4.66
13	12.10	19.20	29.34	16.00	25.94	138.06	7.57	154.06	9.94
14	7.20	13.10	19.01	15.00	28.09	136.91	6.30	151.91	13.09
15	12.20	17.70	23.73	30.00	46.50	103.50	6.93	133.50	16.50
16	9.20	20.90	27.97	14.00	33.34	132.66	12.59	146.66	19.34
17	10.50	13.30	21.96	20.00	25.67	134.33	3.03	154.33	5.67
18	9.20	19.20	26.29	15.00	32.69	132.31	10.80	147.31	17.69
19	7.20	13.30	18.33	19.00	36.97	124.03	6.82	143.03	17.97
20	13.50	20.40	25.96	31.00	51.10	97.90	9.01	128.90	20.10
21	10.80	20.80	24.48	26.00	57.59	96.41	12.91	122.41	31.59
22	13.00	12.20	23.91	19.00	17.79	143.21	0.84	162.21	1.21
23	13.60	20.40	22.92	36.00	61.85	82.15	10.09	118.15	25.85
24	11.40	12.50	22.88	16.00	17.59	146.41	1.15	162.41	1.59
25	8.00	16.80	23.99	10.00	21.39	148.61	9.10	158.61	11.39
26.	(a-d) no triangles exist.								

EXERCISE 9.5.3

1. 30.64 km 2. 4.57 m 3. 476.4 m 4. $201^\circ 47'\text{T}$ 5. 222.9 m 6. (a) 3.40 m (b) 3.11 m
 7. (b) 1.000 m (c) 1.715 m 8. (a) 51.19 min (b) 1 hr 15.96 min (c) 14.08 km 9. \$4886 10. 906 m

EXERCISE 9.5.4

	a cm	b cm	c cm	A	B	C
1	13.5	9.8	16.7	54°	36°	90°
2	8.9	10.8	15.2	35°	44°	101°
3	22.8	25.6	12.8	63°	87°	30°
4	21.1	4.4	21.0	85°	12°	83°
5	15.9	10.6	15.1	74°	40°	66°
6	8.8	13.6	20.3	20°	32°	128°
7	9.2	9.5	13.2	44°	46°	90°
8	23.4	62.5	58.4	22°	89°	69°

9	10.5	9.6	15.7	41°	37°	102°
10	21.7	36.0	36.2	35°	72°	73°
11	7.6	3.4	9.4	49°	20°	111°
12	7.2	15.2	14.3	28°	83°	69°
13	9.1	12.5	15.8	35°	52°	93°
14	14.9	11.2	16.2	63°	42°	75°
15	2.0	0.7	2.5	38°	13°	129°
16	7.6	3.7	9.0	56°	24°	100°
17	18.5	9.8	24.1	45°	22°	113°
18	20.7	16.3	13.6	87°	52°	41°
19	14.6	22.4	29.9	28°	46°	106°
20	7.0	6.6	9.9	45°	42°	93°
21	21.8	20.8	23.8	58°	54°	68°
22	1.1	1.7	1.3	41°	89°	50°
23	1.2	1.2	0.4	85°	76°	19°
24	23.7	27.2	29.7	49°	60°	71°
25	3.4	4.6	5.2	40°	60°	80°

EXERCISE 9.5.5

1. (a) 10.14 km (b) 121°T 2. 7° 33' 3. 4.12 cm 4. 57.32 m 5. 315.5 m 6. (a) 124.3 km
(b) W28° 47' S

EXERCISE 9.5.6

1. 39.60m 52.84m 2. 30.2m 3. 54°, 42°, 84° 4. 37° 5. 028°T. 6. 108.1cm 7. (i) 135° (ii) 136cm
8. 41°, 56°, 83° 9. (i) 158° left (ii) 43.22km 10. 264m 11. 53.33cm 12. 186m 13. 50.12cm
14. 5.17cm 15. (a) 5950m (b) 13341m (c) 160° (d) 243° 17. (a) 20.70° (b) 2.578 m (c) 1.994 m³
18. (a) 4243 m² (b) 86 m (c) 101 m

EXERCISE 9.6

1. 5.36 cm 2. 12.3 m 3. 24 m 4. 40.3 m, 48.2° 5. 16.5 min, 8.9° 6. ~10:49 am

7. (a) i. $\frac{d \sin \phi}{\sin(\phi - \theta)}$ ii. $\frac{d \sin \theta}{\sin(\phi - \theta)}$ (b) $\frac{d \sin \phi \tan \alpha}{\sin(\phi - \theta)}$ or $\frac{d \sin \theta \tan \beta}{\sin(\phi - \theta)}$ (c) $d \left(\frac{\sin \phi \cos \theta}{\sin(\phi - \theta)} - 1 \right)$

EXERCISE 9.7

1. (i) $\frac{169\pi}{150}$ cm², 5.2 + $\frac{13\pi}{15}$ cm (ii) $\frac{529\pi}{32}$ cm², 23 + $\frac{23\pi}{8}$ cm (iii) 242π cm², 88 + 11π cm

- (iv) $\frac{1156\pi}{75}$ m², 13.6 + $\frac{68\pi}{15}$ m (v) $\frac{96\pi}{625}$ cm², 1.28 + $\frac{12\pi}{25}$ cm (vi) $\frac{361\pi}{15}$ cm², 15.2 + $\frac{19\pi}{3}$ cm

- (vii) 5248.8π m², 648 + 32.4π cm (viii) $\frac{12943\pi}{300}$ cm², 17.2 + $\frac{301\pi}{30}$ cm

- (ix) $\frac{1922\pi}{75}$ cm², 12.4 + $\frac{124\pi}{15}$ cm (x) $\frac{15884\pi}{3}$ cm², 152 + $\frac{418\pi}{3}$ cm (xi) 12π cm², 24 + 2π cm

- (xii) $\frac{98\pi}{3}$ cm², 28 + $\frac{14\pi}{3}$ cm (xiii) $\frac{196\pi}{75}$ cm², 5.6 + $\frac{28\pi}{15}$ cm (xiv) $\frac{11532\pi}{25}$ cm², 49.6 + $\frac{186\pi}{5}$ cm

- (xv) $\frac{3\pi}{50}$ cm², 2.4 + $\frac{\pi}{10}$ cm 2. 0.63°, 36° 3. 0.0942m³ 4. 1.64° 5. 79cm 6. 5.25cm²

7. (a) 31.83m (b) 406.28m (c) 11° 8. 1.11° 9. 0.75° 10. (a) 1.85° (b) i. 37.09 cm ii. 88.57 cm
(c) 370.92cm² 11. 26.57 cm² 12. 193.5 cm 13. (a) 105.22 cm (b) 118.83 cm 14. (a) 9 cm

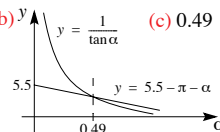
- (b) 12 cm (c) 36°52' 15. (b)  (c) 0.49 16. 1439.16 cm²

EXERCISE 10.1

1. (a) 120° (b) 108° (c) 216° (d) 50° 2. (a) π^c (b) $\frac{3\pi^c}{2}$ (c) $\frac{7\pi^c}{9}$ (d) $\frac{16\pi^c}{9}$ 3. (a) $\frac{\sqrt{3}}{2}$ (b) $-\frac{1}{2}$

- (c) $-\sqrt{3}$ (d) -2 (e) $-\frac{1}{2}$ (f) $-\frac{\sqrt{3}}{2}$ (g) $\frac{1}{\sqrt{3}}$ (h) $\sqrt{3}$ (i) $-\frac{1}{\sqrt{2}}$ (j) $-\frac{1}{\sqrt{2}}$ (k) 1 (l) $-\sqrt{2}$ (m) $-\frac{1}{\sqrt{2}}$ (n) $\frac{1}{\sqrt{2}}$

- (o) -1 (p) $\sqrt{2}$ (q) 0 (r) 1 (s) 0 (t) undefined 4. (a) 0 (b) -1 (c) 0 (d) -1 (e) $\frac{1}{\sqrt{2}}$ (f) $-\frac{1}{\sqrt{2}}$ (g) -1

- (h) $\sqrt{2}$ (i) $-\frac{1}{2}$ (j) $-\frac{\sqrt{3}}{2}$ (k) $\frac{1}{\sqrt{3}}$ (l) $\sqrt{3}$ (m) $-\frac{\sqrt{3}}{2}$ (n) $\frac{1}{2}$ (o) $-\sqrt{3}$ (p) 2 (q) $-\frac{1}{\sqrt{2}}$ (r) $\frac{1}{\sqrt{2}}$ (s) -1

- (t) $-\sqrt{2}$ 5. (a) $\frac{1}{2}$ (b) $\frac{\sqrt{3}}{2}$ (c) 1 (d) $\frac{1}{2}$ (e) $-\frac{1}{\sqrt{3}}$ (f) $-\frac{1}{2}$ (g) $-\sqrt{2}$ (h) $-\frac{2}{\sqrt{3}}$ 6. (a) $-\frac{1}{2}$ (b) $-\frac{1}{\sqrt{2}}$

- (c) $\sqrt{3}$ (d) -2 (e) 1 (f) $\frac{1}{2}$ (g) $-\frac{1}{\sqrt{3}}$ (h) $-\frac{\sqrt{3}}{2}$ (i) $-\frac{2}{\sqrt{3}}$ (j) $\frac{1}{\sqrt{3}}$ (k) $\frac{2}{\sqrt{3}}$ (l) $-\frac{\sqrt{3}}{2}$ 7. (a) $\left(\frac{1}{2}, \frac{\sqrt{3}}{2}\right)$

- (b) $\left(-\frac{1}{2}, \frac{\sqrt{3}}{2}\right)$ (c) $\left(-\frac{1}{\sqrt{2}}, -\frac{1}{\sqrt{2}}\right)$ (d) $\left(\frac{\sqrt{3}}{2}, \frac{1}{2}\right)$ 8. (a) 0 (b) $\frac{\sqrt{3}}{2}$ (c) $\frac{1}{\sqrt{3}}$ (d) $\frac{1+\sqrt{3}}{2\sqrt{2}}$ 10. (a) $-\frac{2}{3}$

- (b) $-\frac{2}{3}$ (c) $-\frac{2}{3}$ 11. (a) $-\frac{2}{5}$ (b) $\frac{5}{2}$ (c) $\frac{2}{5}$ 12. (a) k (b) $-\frac{1}{k}$ (c) -k 13. (a) $\frac{\sqrt{5}}{3}$ (b) $\frac{3}{\sqrt{5}}$ (c) $-\frac{\sqrt{5}}{3}$

14. (a) $-\frac{3}{5}$ (b) $\frac{3}{4}$ (c) $\frac{4}{5}$ 15. (a) $\frac{4}{5}$ (b) $\frac{3}{4}$ (c) $-\frac{5}{3}$ 16. (a) -k (b) $-\sqrt{1-k^2}$ (c) $-\frac{k}{\sqrt{1-k^2}}$

17. (a) $-\sqrt{1-k^2}$ (b) $\frac{k}{\sqrt{1-k^2}}$ (c) $-\frac{1}{\sqrt{1-k^2}}$ 18. (a) sin θ (b) cot θ (c) 1 (d) 1 (e) cot θ (f) tan θ

19. (a) $\frac{\pi}{3}, \frac{2\pi}{3}$ (b) $\frac{\pi}{3}, \frac{5\pi}{3}$ (c) $\frac{\pi}{3}, \frac{4\pi}{3}$ (d) $\frac{5\pi}{6}, \frac{7\pi}{6}$ (e) $\frac{5\pi}{6}, \frac{11\pi}{6}$ (f) $\frac{7\pi}{6}, \frac{11\pi}{6}$

EXERCISE 10.2.1

3. (a) $x^2 + y^2 = k^2, -k \leq x \leq k$ (b) $\frac{x^2}{b^2} + \frac{y^2}{a^2} = 1, -b \leq x \leq b$ (c) $(x-1)^2 + (2-y)^2 = 1, 0 \leq x \leq 2$

- (d) $\frac{(1-x)^2}{b^2} + \frac{(y-2)^2}{a^2} = 1$ (e) $5x^2 + 5y^2 + 6xy = 16$ 4. (a) (i) $-\frac{4}{5}$ (ii) $-\frac{5}{3}$ (b) (i) $\frac{4}{\sqrt{7}}$ (ii) $-\frac{\sqrt{7}}{3}$

5. (a) $\frac{\pi}{3}, \frac{2\pi}{3}, \frac{4\pi}{3}, \frac{5\pi}{3}$ (b) $\frac{\pi}{2}, \frac{7\pi}{6}, \frac{11\pi}{6}$ (c) 0, $\frac{\pi}{6}, \frac{5\pi}{6}, \pi, 2\pi$ (d) $\frac{\pi}{2}, \frac{3\pi}{2}$ 9. (a) $\frac{2a}{a^2+1}$ (b) $\frac{a^2-1}{a^2+1}$

10. (a) i. 1 ii. 1 (b) 1 11. (a) $\frac{1-\sqrt{x^2-1}}{x}$ (b) $\frac{1+\sqrt{x^2-1}}{x}$ (c) $\frac{2}{x^2} - 1$ 12. (a) i. 6 ii. $\frac{5}{2}$ iii. $\frac{9}{8}$

- (b) i. 5 ii. 1 iii. -2 13. (a) ±2 (b) $\frac{\pi}{6} + 2k\pi, k \in \mathbb{Z}$ or $\frac{7\pi}{6} + 2k\pi, k \in \mathbb{Z}$

14. (a) i. 25 ii. $\frac{1}{5^4}$ (b) i. 27 ii. $\frac{1}{3}$ 15. (a) $1 + 2k$ (b) $(1 - k)\sqrt{1 + 2k}$

16. (a) $\frac{1-a}{2\sqrt{a}}$ (b) i. $2 + \sqrt{2a - a^2}$ ii. $\frac{-\sqrt{2a - a^2}}{1 - a}$ 17. (a) $\frac{2}{3}$ (b) $0, \pm \frac{2\sqrt{2}}{3}$ 18. $0, \frac{\pi}{3}, \frac{2\pi}{3}, \pi$

EXERCISE 10.2.2

1. (a) $\sin\alpha\cos\phi + \cos\alpha\sin\phi$ (b) $\cos 3\alpha\cos 2\beta - \sin 3\alpha\sin 2\beta$ (c) $\sin 2x\cos y - \cos 2x\sin y$

(d) $\cos\phi\cos 2\alpha + \sin\phi\sin 2\alpha$ (e) $\frac{\tan 2\theta - \tan\alpha}{1 + \tan 2\theta\tan\alpha}$ (f) $\frac{\tan\phi - \tan 3\omega}{1 + \tan\phi\tan 3\omega}$ 2. (a) $\sin(2\alpha - 3\beta)$

(b) $\cos(2\alpha + 5\beta)$ (c) $\sin(x + 2y)$ (d) $\cos(x - 3y)$ (e) $\tan(2\alpha - \beta)$ (f) $\tan x$ (g) $\tan\left(\frac{\pi}{4} - \phi\right)$

(h) $\sin\left(\frac{\pi}{4} + \alpha + \beta\right)$ (i) $\sin 2x$ 3. (a) $-\frac{56}{65}$ (b) $\frac{33}{65}$ (c) $-\frac{16}{63}$ 4. (a) $\frac{16}{65}$ (b) $\frac{63}{65}$ (c) $\frac{56}{33}$

5. (a) $-\frac{5\sqrt{11}}{18}$ (b) $-\frac{7}{18}$ (c) $\frac{5\sqrt{11}}{7}$ (d) $\frac{35\sqrt{11}}{162}$ 6. (a) $\frac{3}{5}$ (b) $-\frac{4}{5}$ (c) $\frac{3}{4}$ (d) $\frac{24}{7}$ 7. (a) $\frac{1 + \sqrt{3}}{2\sqrt{2}}$

(b) $\frac{1 + \sqrt{3}}{2\sqrt{2}}$ (c) $-\frac{1 + \sqrt{3}}{2\sqrt{2}}$ (d) $\sqrt{3} - 2$ 8. (a) $\frac{2ab}{a^2 + b^2}$ (b) $\frac{a^2 + b^2}{2ab}$ (c) $\frac{a^4 - 6a^2b^2 + b^4}{(a^2 + b^2)^2}$ (d) $\frac{2ab}{b^2 - a^2}$

12. $\sqrt{2} - 1$ 14. (a) $0, \frac{\pi}{3}, \pi, \frac{5\pi}{3}, 2\pi$ (b) $\frac{\pi}{6}, \frac{5\pi}{6}, \frac{3\pi}{2}$ (c) $0, \pi, 2\pi, \alpha, \pi \pm \alpha, 2\pi - \alpha, \alpha = \tan^{-1}\left(\frac{1}{\sqrt{2}}\right)$

15. (a) $R = \sqrt{a^2 + b^2}, \tan\alpha = \frac{b}{a}$ (b) 10 16. (a) $R = \sqrt{a^2 + b^2}, \tan\alpha = \frac{b}{a}$ (b) -11 18. $2 - \sqrt{3}$

EXERCISE 10.3

1. (a) 4π (b) $\frac{2\pi}{3}$ (c) 3π (d) 4π (e) 2 (f) $\frac{\pi}{2}$ 2. (a) 5 (b) 3 (c) 5 (d) 0.5 3. (a) $2\pi, 2$ (b) $6\pi, 3$ (c) π

(d) π (e) $\pi, 4$ (f) $\pi, 3$ (g) 6π (h) $\frac{2\pi}{3}, \frac{1}{4}$ (i) 3π (j) $\frac{8\pi}{3}, \frac{2}{3}$

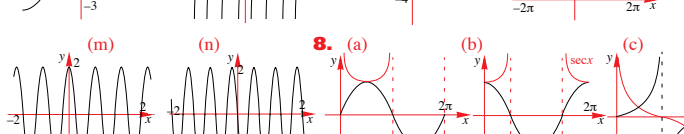
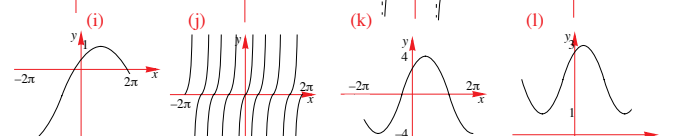
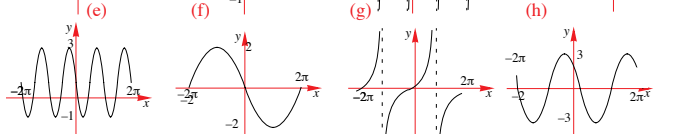
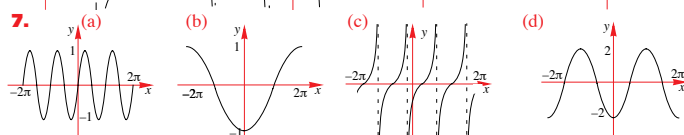
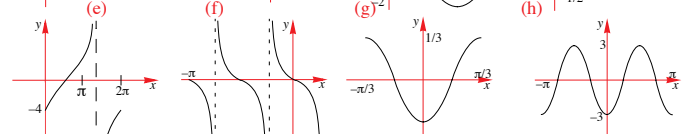
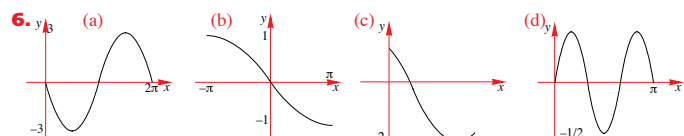
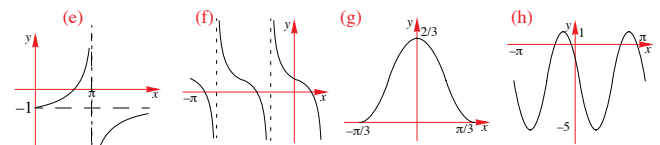
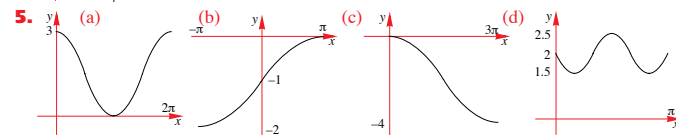
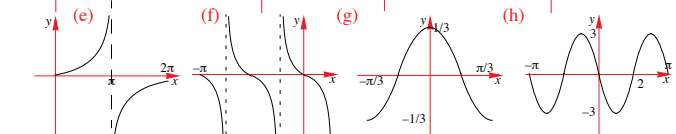
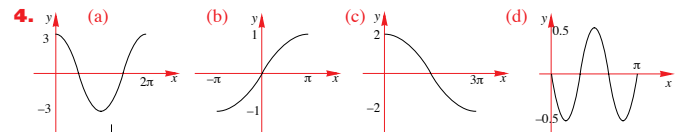

EXERCISE 10.4

1. (a) $\frac{\pi}{4}$ (b) $\frac{\pi}{2}$ (c) π (d) $\frac{\pi}{3}$ (e) $\frac{\pi}{4}$ (f) $-\frac{\pi}{3}$ (g) 1.1071° (h) -0.7754° (i) 0.0997° (j) 1.2661°

(k) -0.6435° (l) 1.3734° (m) undefined (n) -1.5375° (o) 1.0654° 2. (a) -1 (b) $\frac{\sqrt{3}}{4}$ (c) $-\frac{1}{3\sqrt{2}}$

4. $\frac{1}{3}, \frac{1}{2}$ 5. (a) $\frac{2}{3}$ (b) $\frac{1}{3}$ (c) $\frac{1}{2}$ (d) $\frac{3}{4}$ (e) $\frac{3\sqrt{2}}{4}$ (f) -1 6. (a) 1 (b) $-\frac{7}{25}$ (c) $\frac{63}{65}$ (d) undefined

(e) $\frac{4\sqrt{5}}{9}$ (f) $\frac{3}{5}$ (g) $\frac{4}{3}$ (h) $\frac{1}{2}$ 9. (a) $\frac{\sqrt{1-k^2}}{k}$ (b) $\frac{1}{\sqrt{1+k^2}}$

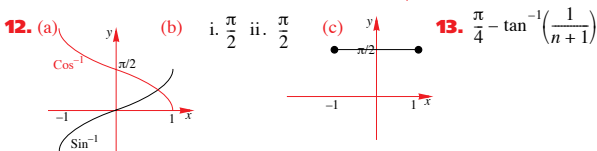
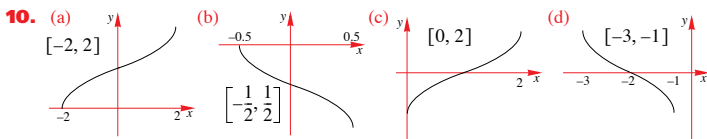

13. $\frac{\pi}{4} - \tan^{-1}\left(\frac{1}{n+1}\right)$

EXERCISE 10.5

1. (a) $\frac{\pi}{4}, \frac{3\pi}{4}$ (b) $\frac{7\pi}{6}, \frac{11\pi}{6}$ (c) $\frac{\pi}{3}, \frac{2\pi}{3}$ (d) $\frac{\pi}{18}, \frac{5\pi}{18}, \frac{13\pi}{18}, \frac{17\pi}{18}, \frac{25\pi}{18}, \frac{29\pi}{18}$ (e) $\frac{\pi}{3}, \frac{5\pi}{3}$
 (f) $\frac{5}{4}, \frac{7}{4}, \frac{13}{4}, \frac{15}{4}, \frac{21}{4}, \frac{23}{4}$ 2. (a) $\frac{\pi}{4}, \frac{7\pi}{4}$ (b) $\frac{2\pi}{3}, \frac{4\pi}{3}$ (c) $\frac{\pi}{6}, \frac{11\pi}{6}$ (d) π (e) $\frac{\pi}{6}, \frac{5\pi}{6}, \frac{7\pi}{6}, \frac{11\pi}{6}$ (f) $\frac{3}{2}, \frac{5}{2}$

3. (a) $\frac{\pi}{6}, \frac{7\pi}{6}$ (b) $\frac{3\pi}{4}, \frac{7\pi}{4}$ (c) $\frac{\pi}{3}, \frac{4\pi}{3}$ (d) $4 \tan^{-1} 2$ (e) $\frac{\pi}{3}, \frac{5\pi}{6}, \frac{4\pi}{3}, \frac{11\pi}{6}$ (f) 3 4. (a) $90^\circ, 330^\circ$
 (b) $180^\circ, 240^\circ$ (c) $90^\circ, 270^\circ$ (d) $65^\circ, 335^\circ$ (e) $\frac{\pi}{12}, \frac{5\pi}{12}, \frac{13\pi}{12}, \frac{17\pi}{12}$ (f) $0, \pi, 2\pi$ (g) $\frac{\pi}{3}, \frac{2\pi}{3}, \frac{4\pi}{3}, \frac{5\pi}{3}$

(h) $\frac{3\pi}{8}, \frac{7\pi}{8}, \frac{11\pi}{8}, \frac{15\pi}{8}$ 5. (a) $60^\circ, 300^\circ$ (b) $\frac{4\pi}{3}, \frac{5\pi}{3}$ (c) $\frac{\pi}{6}, \frac{7\pi}{6}$ (d) $23^\circ 35', 156^\circ 25'$ (e) $\frac{\pi}{3}, \frac{2\pi}{3}, \frac{4\pi}{3}, \frac{5\pi}{3}$
 (f) $\frac{2\pi}{3}, \frac{5\pi}{3}$ (g) $\frac{5\pi}{6}, \frac{9\pi}{6}$ (h) $3.3559^\circ, 5.2105^\circ$ (i) $\frac{\pi}{3}, \frac{4\pi}{3}$ (j) $\frac{\pi}{3}, \frac{2\pi}{3}, \frac{4\pi}{3}, \frac{5\pi}{3}$ (k) $\frac{\pi}{6}, \frac{2\pi}{3}, \frac{7\pi}{6}, \frac{5\pi}{3}$

(l) $68^\circ 12', 248^\circ 12'$ (m) $\frac{\pi}{3}, \frac{5\pi}{3}$ (n) $\frac{\pi}{4}, \frac{3\pi}{4}, \frac{5\pi}{4}, \frac{7\pi}{4}$ (o) \emptyset 6. (a) $-\frac{3\pi}{4}, \frac{\pi}{4}$ (b) $\pm \frac{\pi}{3}$ (c) $-\frac{7\pi}{8}, \frac{3\pi}{8}, \frac{\pi}{8}, \frac{5\pi}{8}$
 (d) $-\frac{\pi}{2}$ (e) $\pm \frac{\pi}{2}$ (f) $\frac{\pi}{8}, \frac{7\pi}{8}, \frac{9\pi}{8}, \frac{15\pi}{8}$ (g) $\frac{\pi}{2}, \frac{3\pi}{2}$ (h) $\frac{\pi}{2}, \frac{3\pi}{2}$ 7. (a) $\frac{3\pi}{4}, \frac{7\pi}{4}, \tan^{-1}\left(\frac{2}{3}\right), \pi + \tan^{-1}\left(\frac{2}{3}\right)$

(b) $\frac{\pi}{3}, \frac{2\pi}{3}, \frac{3\pi}{4}, \frac{4\pi}{3}, \frac{5\pi}{3}, \frac{7\pi}{4}$ 8. (a) $\frac{\pi}{12}, \frac{5\pi}{12}, \frac{7\pi}{12}, \frac{11\pi}{12}, \frac{13\pi}{12}, \frac{17\pi}{12}, \frac{19\pi}{12}, \frac{23\pi}{12}$ (b) $\frac{2\pi}{3}, \frac{4\pi}{3}$
 (c) $0, 1, 2, 3, 4, 5, 6$ 9. (a) $\frac{\pi}{3}, \frac{5\pi}{3}, \pi \pm \cos^{-1}\left(\frac{1}{4}\right)$ (b) $\frac{3\pi}{4}, \frac{7\pi}{4}, \tan^{-1}(3), \pi + \tan^{-1}(3)$

(c) $\frac{\pi}{6}, \frac{7\pi}{6}, \frac{\pi}{2}, \frac{3\pi}{2}$ (d) $\tan^{-1}\left(\frac{3}{2}\right), \pi - \tan^{-1}(2), \pi + \tan^{-1}\left(\frac{3}{2}\right), 2\pi - \tan^{-1}(2)$ 10. (a) $2 \sin\left(x + \frac{\pi}{6}\right)$

(b) $0, \frac{2\pi}{3}, 2\pi$ 11. (a) $2 \sin\left(x - \frac{\pi}{3}\right)$ (b) $\frac{\pi}{6}, \frac{3\pi}{2}$ 12. $\frac{\pi}{3}, \frac{2\pi}{3}$ 13. i. $\left(\frac{\pi}{6}, \frac{5\pi}{6}\right) \cup \left(\frac{13\pi}{6}, \frac{17\pi}{6}\right)$

ii. $\left(\pi + \sin^{-1}\left(\frac{1}{\sqrt{3}}\right), 2\pi - \sin^{-1}\left(\frac{1}{\sqrt{3}}\right)\right) \cup \left(3\pi + \sin^{-1}\left(\frac{1}{\sqrt{3}}\right), 4\pi - \sin^{-1}\left(\frac{1}{\sqrt{3}}\right)\right)$

14. (a) ii. $\left[0, \frac{\pi}{4}\right] \cup \left(\frac{5\pi}{4}, 2\pi\right]$ (b) ii. $\left[0, \frac{\pi}{6}\right] \cup \left(\frac{\pi}{2}, \frac{5\pi}{6}\right) \cup \left(\frac{3\pi}{2}, 2\pi\right]$

16. (a) i. $\{x|x = k\pi + \alpha(-1)^k, k \in \mathbf{Z}\}$ ii. $\{x|2k\pi + \alpha \leq x \leq (2k+1)\pi - \alpha, k \in \mathbf{Z}\}$

(b) $\left\{x|x = (2k+1)\frac{\pi}{5}\right\} \cup \{x|x = 2k\pi, k \in \mathbf{Z}\}$

(c) $\left\{x|x = \frac{2k\pi}{5} + \frac{\pi}{10}\right\} \cup \left\{x|x = 2k\pi - \frac{\pi}{2}\right\}, k \in \mathbf{Z}$ 17. (a) $0, \frac{\pi}{3}, \frac{5\pi}{3}, 2\pi$ (b) $\sqrt{2}, \frac{\sqrt{2}}{2}$

18. (c) $2 \cos \frac{\pi}{9}, 2 \cos \frac{5\pi}{9}, 2 \cos \frac{7\pi}{9}$ 19. $\left\{\pm \frac{\pi}{4}, \pm \frac{2\pi}{3}, \pm \frac{3\pi}{4}\right\}$ 21. (a) $90^\circ, 199^\circ 28', 340^\circ 32'$

(b) $(199^\circ 28', 340^\circ 32')$ 24. $\left\{(x, y)|x = 2k\pi + \frac{\pi}{2}, y = 2k\pi\right\} \cup \left\{(x, y)|x = 2k\pi - \frac{\pi}{2}, y = 2k\pi + \pi\right\}, k \in \mathbf{Z}$

EXERCISE 10.6

1. (a) 5, 24, 11, 19 (b) $T = 5 \sin\left(\frac{\pi t}{12} - 3\right) + 19$ (c) 23.6° 2. (a) 3, 4.2, 2, 7

(b) $L = 3 \sin\left(\frac{\pi t}{2.1} - 3\right) + 7$ 3. (a) 5, 11, 0, 7 (b) $V = 5 \sin\left(\frac{2\pi t}{11}\right) + 7$ 4. (a) 1, 11, 1, 12

(b) $P = \sin \frac{2\pi}{11}(t-1) + 12$ 5. (a) 2.6, 7, 2, 6 (b) $S = 2.6 \sin \frac{2\pi}{7}(t-2) + 6$ 6. (a) 0.6, 3.5, 0, 11

(b) $P = 0.6 \sin\left(\frac{4\pi t}{7}\right) + 11$ 7. (a) 0.8, 4.6, 2.7, 11 (b) $D = 0.8 \sin \frac{\pi}{2.3}(t-2.7) + 11$ 8. (a) 3000

(b) 1000, 5000 (c) $\frac{4}{9}$ 9. (a) 6.5 m, 7.5 m (b) 1.58 sec, 3.42 sec 10. (a) 750, 1850 (b) 3.44

(c) Mid-April to End of August

11. (a) 15000 (b) 12 months (c) (d) 4 months

12. (a) $\pi, -2.2$ (b) $\frac{1}{3}$ m (c) $\frac{4}{3}$ m

13. (a)

t	0	0.5	1	1.5	2	2.5	3	3.5	4
$F(t)$	6	8	6	4	6	8	6	4	6
$G(t)$	4	4.0625	4.25	4.5625	5	5.5625	6.25	7.0625	8

(b) (c) 3 (d) 38.45%

14. (a) (b) i. 7, 11, 19, 23
 ii. $[0, 7] \cup [11, 19] \cup [23, 24]$
 (c) 14.9m

EXERCISE 11.1

1. a. i. 2 ii. -3 iii. 6 iv. 0 v. $\frac{3}{2}$ vi. $\frac{1}{3}$ b. i. 2 ii. $\sqrt{2}$ iii. -5 iv. $-\frac{2}{5}$ v. $\frac{1}{2}$ vi. -1 c. i. 2 - 2i ii. -3 - $\sqrt{2}i$
 iii. 6 + 5i iv. $\frac{2}{5}i$ v. $\frac{3}{2} - \frac{1}{2}i$ vi. $\frac{1}{3} + i$ 2. a. 7 + i b. 1 - 3i c. 15 - 8i d. -1 - 8i e. 10 + 11i
 f. -2 + 3i 3. a. -1 + 3i b. 5 - i c. -4 + 3i d. 6i e. -4 + 7i f. -2 + 3i 4. a. $\frac{1}{2}(1 + i)$
 b. $-\frac{1}{2}(5 + i)$ c. -1 - 2i d. $\frac{1}{2}i$ e. 1 f. $-\frac{1}{13}(5 + i)$ 5. a. 14 + 8i b. -2 - 2i c. -2 $\sqrt{2} - i$
 d. $\frac{1}{5}(2 + i)$ e. 2 - i f. $\frac{1}{5}(1 + 3i)$ 6. a. $\frac{1}{2}$ b. $\frac{1}{2}(3 + \sqrt{2})$ c. 3 + $\sqrt{2}$ 7. a. x = 4, y = $-\frac{1}{2}$
 b. x = -5, y = 12 c. x = 0, y = 5 8. a. i. 1, i, -1, -i, 1, i ii. -i, -1, i, 1, -i b. i. -1 ii. -i
 iii. -1 iv. -1 9. x = $-\frac{120}{29}$, y = $\frac{39}{29}$ 12. a. x = 0 or y = 0 or both b. x² - y² = 1 13. a. 3 - i
 b. 2 - i 14. a. 4i b. -4 c. -i 15. a. x = 13, y = 4 b. x = 4, y = $\frac{4}{3}$ 16. 1 17. $-\frac{1}{3}(1 + 2\sqrt{2}i)$

18. (u, v) = $(\frac{1}{2}(\sqrt{2} + 2), \frac{1}{2}\sqrt{2})$, $(\frac{1}{2}(2 - \sqrt{2}), -\frac{1}{2}\sqrt{2})$ 19. (a) $\frac{7}{2}$ (b) $\frac{1}{5}$ 21. $\pm \frac{\sqrt{2}(1 + i)}{2}$
 22. (a) cos(θ + α) + i sin(θ + α) (b) cos(θ - α) + i sin(θ - α)
 (c) r₁r₂(cos(θ + α) + i sin(θ + α)) (d) x² - 2x cos(θ) + 1 (e) x² + 2x sin(α) + 1 24. (a) 3 + i
 (b) 325 (c) (x² + y²)² 25. z = 4, b = -4 26. (a) cos(θ) + i sin(θ) (b) cos(4θ) + i sin(4θ)

27. (a) $\begin{bmatrix} -\alpha^2 & 0 \\ 0 & -\beta^2 \end{bmatrix}$ (b) $\begin{bmatrix} \alpha^4 & 0 \\ 0 & \beta^4 \end{bmatrix}$ (c) $\begin{bmatrix} -i & 0 \\ \alpha & \beta \end{bmatrix}$ (d) $\begin{bmatrix} \alpha^{4n} & 0 \\ 0 & \beta^{4n} \end{bmatrix}$ 28. (a) -sin(θ) + i cos(θ)

(d) cos(θ) - i sin(θ)

EXERCISE 11.2

1. The points to plot are: (2, 1), (0, -6), (4, -3), (2, -2), (-3, 3), (-3, 4), (0, -0.5), (1, -1). 2. (a) i. i - 1
 ii. -(1 + i) iii. 1 - i iv. 1 + i; Anticlockwise rotation of 90°. (b) i. Reflection about the Re(z) axis.
 ii. Results will always be a real number, so the point will always lie on Re(z) axis. iii. Point
 will always lie on the Im(z) axis. 3. (a) -3 + 4i (b) $\frac{1}{2}(1 - i)$ (c) -1 + 3i (d) 1 + 3i
 (e) -1 - 3i (f) 2 - 3i (g) $\frac{1}{2}(3 + i)$ (h) $\frac{1}{5}(3 - i)$ 4. (a) 2; $\frac{\pi}{3}$ (b) 2; $-\frac{\pi}{3}$ (c) $\sqrt{3}$; arctan($\sqrt{2}$)
 (d) 3; $\frac{\pi}{2}$ (e) 1; $-\frac{2\pi}{3}$ (f) 1; $\frac{\pi}{4}$ (g) 6; 0 (h) $\frac{5}{4}$; $-\arctan(\frac{4}{3})$ 5. (a) $\sqrt{a^2 + b^2}$; $\sqrt{a^2 + b^2}$; a² + b²
 (b) i. $\frac{\pi}{2}$ or $-\frac{\pi}{2}$ ii. 0 or π 6. i. $\sqrt{2x^2 + 18}$ ii. ±3 7. Triangle property; the sum of the lengths of
 two sides of a triangle is larger than the third side. 8. 0 9. (a) 15 (b) 5 (c) 10 12. (b) 1 + i
 14. (a) 5; -53.13° (b) $\sqrt{2}$; -45° (c) 1; -90° 15. $\frac{\pi}{4}$; π 16. (a) 1; θ (b) 1; $\frac{\pi}{2} - \theta$ (c) 1; -θ
 17. (a) |sec α|, α - π (for Principal argument) otherwise, α + kπ, where k is an integer.

(b) |sec α|, α + $\frac{\pi}{2}$ (for Principal argument) otherwise, $(\alpha + \frac{\pi}{2}) + k\pi$, k is an integer.

(c) $2 \left| \cos\left(\frac{\theta}{2}\right) \right|$; $\frac{\theta}{2}$ (for Principal argument) otherwise, $\frac{\theta}{2} + k\pi$, k is an integer.

18. (a) i. $\frac{\sqrt{3}}{2} + \frac{i}{2}$ ii. $\frac{\pi}{6}$ (b) $-\frac{5\pi}{6}$ 19. (a) i. $2 \sin \frac{\theta}{2}$ ii. $\frac{\theta - \pi}{2}$ (b)

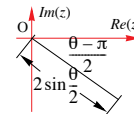

EXERCISE 11.3

1. (a) $\sqrt{2} \operatorname{cis}\left(\frac{\pi}{4}\right)$ (b) $\sqrt{2} \operatorname{cis}\left(\frac{3\pi}{4}\right)$ (c) $\sqrt{2} \operatorname{cis}\left(-\frac{3\pi}{4}\right)$ 2. (a) $2\sqrt{2} \operatorname{cis}\left(\frac{\pi}{4}\right)$ (b) $2 \operatorname{cis}\left(\frac{\pi}{6}\right)$
 (c) $4\sqrt{2} \operatorname{cis}\left(-\frac{\pi}{4}\right)$ (d) $5 \operatorname{cis}(53^\circ 7')$ (e) $\sqrt{5} \operatorname{cis}(153^\circ 26')$ (f) $\sqrt{13} \operatorname{cis}(-123^\circ 41')$ (g) $2 \operatorname{cis}\left(\frac{5\pi}{6}\right)$
 (h) $\operatorname{cis}\left(-\frac{\pi}{3}\right)$ (i) $\sqrt{10} \operatorname{cis}(-18^\circ 26')$ 3. (a) 2i (b) $\frac{3\sqrt{3}}{2} + \frac{3}{2}i$ (c) 1 - i (d) -5i (e) -4 + 4 $\sqrt{3}i$
 (f) $\frac{1}{6}(\sqrt{2} + \sqrt{6}i)$ 4. (a) $\sqrt{\frac{5}{3}}$ (b) 1 (c) 0 5. (a) 1 - $\sqrt{3}i$ (b) 1 - i (c) (1 - $\sqrt{3}$) + (1 + $\sqrt{3}$)i
 7. (a) $\sqrt{2}$ (b) 2 (c) $2\sqrt{2}$ (d) $\frac{\pi}{4}$ (e) $\frac{2\pi}{3}$ (f) $\frac{11\pi}{12}$ 8. (a) -4(1 + i) (b) -4 (c) -16 + 16i
 (d) -8 - 8 $\sqrt{3}i$ (e) -16 $\sqrt{3}$ - 16i (f) -117 - 44i 9. (a) $\frac{1}{8}(-1 + i)$ (b) $-\frac{1}{4}$ (c) $-\frac{1}{32}(1 + i)$
 (d) $\frac{1}{32}(-1 + \sqrt{3}i)$ (e) $\frac{1}{64}(-\sqrt{3} + i)$ (f) $\frac{1}{15625}(-117 + 44i)$ 10. (a) -8i (b) $\frac{81}{2}(-1 + \sqrt{3}i)$
 (c) $\frac{1}{2}i$ (d) $-\frac{1}{125}i$ (e) $-\frac{1}{16}(1 + \sqrt{3}i)$ (f) $-\frac{2}{81}(1 + \sqrt{3}i)$ 11. (a) 128(1 - i) (b) $4\sqrt{3} - 4i$ (c) -32i
 (d) 256 (e) $\frac{11753}{625} - \frac{10296}{625}i$ (f) -2i 12. (b) i. -1 ii. -1 iii. i 13. (a) -i (b) $6\sqrt{2}(1 + i)$
 (c) $-\sqrt{2} - \sqrt{2} + \sqrt{2} + \sqrt{2}i$ 14. (a) $\frac{\sqrt{2}}{2}(1 + i)$; $\frac{1}{2}(1 + \sqrt{3}i)$ $\frac{\sqrt{2}}{4}((1 - \sqrt{3}) + (1 + \sqrt{3})i)$
 (b) i. $\frac{\sqrt{2}}{4}(1 + \sqrt{3})$ ii. $\frac{\sqrt{2}}{4}(1 - \sqrt{3})$ 20. (c) 3 22. (cis(-θ))³
 23. (cos 2θ + cos 2α)(cos(θ - α) - i sin(θ - α)) [or 2 cos(α - θ)] 25. (a) cosec θ (b) θ - $\frac{\pi}{2}$

EXERCISE 11.4.1

1. (a) (x - 3 + i)(x - 3 - i) (b) (x + 2 + 3i)(x + 2 - 3i) (c) (x - 1 + i)(x - 1 - i)
 (d) (z + 2 + i)(z + 2 - i) (e) $\left(z - \frac{(3 + \sqrt{7}i)}{2}\right)\left(z - \frac{(3 - \sqrt{7}i)}{2}\right)$ (f) (z + 5 + $\sqrt{5}i$)(z + 5 - $\sqrt{5}i$)
 (g) $4\left(w + \frac{1 - 4i}{2}\right)\left(w + \frac{1 + 4i}{2}\right)$ (h) 3(w - 1 + i)(w - 1 - i) (i) $-2\left(w - 2 - \frac{\sqrt{6}i}{2}\right)\left(w - 2 + \frac{\sqrt{6}i}{2}\right)$

2. (a) $-2 \pm 2i$ (b) $\frac{1 \pm \sqrt{11}i}{2}$ (c) $\frac{3 \pm \sqrt{3}i}{6}$ (d) $\frac{-5 \pm \sqrt{7}i}{4}$ (e) $-5 \pm 2i$ (f) $\pm 4i$ (g) $-6 \pm 2i$

(h) $-3 \pm i$ (i) $\pm \frac{5}{3}i$ 3. (a) $\pm 2, \pm i$ (b) $\pm 3, \pm i$ (c) $\pm 3, \pm 2i$ 4. (a) $(z-5i)(z+5i)$

(b) $(z-7i)(z+7i)$ (c) $(z+2+i)(z+2-i)$ (d) $(z+3+\sqrt{2}i)(z+3-\sqrt{2}i)$

(e) $(z-2i)(z+2i)(z-\sqrt{2}i)(z+\sqrt{2}i)$ (f) $(z-\sqrt{2}i)(z+\sqrt{2}i)(z-\sqrt{3}i)(z+\sqrt{3}i)$

EXERCISE 11.4.2

1. (a) $(z+2)(z+i)(z-i)$ (b) $(z-9)(z+i)(z-i)$ (c) $(z-2)(z+\sqrt{2}i)(z-\sqrt{2}i)$

2. (a) $(w+1-\sqrt{5}i)(w+1+\sqrt{5}i)(w-2)$ (b) $(z-1)(z-2+i)(z-2-i)$

(c) $(z-1)(z+1+i)(z+1-i)$ (d) $(x+2)(x-2)(x+i)(x-i)$

(e) $(w+2)(w-1+i)(w-1-i)$ (f) $(z+5)(z-5)(z+5i)(z-5i)$ 3. (a) $1, 3 \pm 4i$ (b) $2, 3 \pm 2i$

(c) $-2, 3, 1 \pm i$ (d) $\frac{1}{2}, -1 \pm i$ (e) $\frac{5}{3}, \frac{3}{2}, 1 \pm \sqrt{2}i$ (f) $-1, -3 \pm i$ 4. $\frac{1}{3}, \frac{-1 \pm \sqrt{3}i}{2}$ 5. $-\frac{1}{2}, 1 \pm 2i$

6. $(z-3)(z-2+3i)(z-2-3i)$ 7. $1 \pm 2i, \frac{-1 \pm \sqrt{11}i}{2}$ 8. (a) $(2z-1)(z+i)(z-i)$

(b) $(z+\sqrt{3})(z-\sqrt{3})(z+2i)(z-2i)$ 9. $2 \pm i, -1$ 10. $2 \pm 3i, -\frac{13}{4}$ 11. $2 \pm i, \frac{1}{2}$

12. $(z-2)(z-4+i)(z-4-i)$ 13. $(z-2)(z-1+i)(z-1-i)$

14. (a) $-2, 1, \frac{-1 \pm \sqrt{3}i}{2}, 1 \pm \sqrt{3}i$ (b) $1, 2, \frac{1 \pm \sqrt{3}i}{2}, -1 \pm \sqrt{3}i$ (c) $\pm \sqrt{3}, \pm i$ (d) $\pm \sqrt{5}, \pm i$

15. (a) $x^3 - 7x^2 + 17x - 15 = 0$ (b) $x^4 - 5x^3 + 10x^2 - 10x + 4 = 0$

(c) $x^3 - 5x^2 + 10x - 12 = 0$ (d) $x^4 + 2x^3 + 2x^2 - 2x + 21 = 0$ 16. $-1 - i\sqrt{3}, 1 \pm \sqrt{5}$

17. $2 \pm i, \frac{1}{2}(-3 \pm \sqrt{5})$

EXERCISE 11.4.3

1. (a) $\frac{3}{2} \pm \frac{3\sqrt{3}}{2}i, 3$ (b) $\pm \frac{3\sqrt{3}}{2} + \frac{3}{2}i, -3i$ (c) $2i, \pm \sqrt{3} - i$

(d) $-\sqrt{2} - \sqrt{2}i, -\sqrt{2} + \sqrt{2}i, \sqrt{2} - \sqrt{2}i, \sqrt{2} + \sqrt{2}i$

(e) $\frac{3}{2}(\sqrt{2} - \sqrt{2}i - \sqrt{2} + \sqrt{2}i), \frac{3}{2}(\sqrt{2} - \sqrt{2}i - \sqrt{2} + \sqrt{2}i), \frac{3}{2}(\sqrt{2} + \sqrt{2}i + \sqrt{2} - \sqrt{2}i)$

$-\frac{3}{2}(\sqrt{2} + \sqrt{2}i + \sqrt{2} - \sqrt{2}i)$ (f) $\pm 2, \sqrt{3} \pm i, -\sqrt{3} \pm i$ 2. $1 \pm i, -1 \pm i$;

$(z-1-i)(z-1+i)(z+1-i)(z+1+i)$ 3. (a) $\pm \frac{1}{\sqrt{2}}(1+i)$ (b) $2+i, -2-i$ (c) $\pm \frac{\sqrt{2}}{2}(1+\sqrt{3}i)$

4. (a) $\sqrt[3]{2}cis\left(-\frac{\pi}{12}\right), \sqrt[3]{2}cis\left(\frac{7\pi}{12}\right), \sqrt[3]{2}cis\left(-\frac{9\pi}{12}\right)$ (b) $\sqrt[3]{2}cis\left(\frac{2\pi}{9}\right), \sqrt[3]{2}cis\left(\frac{8\pi}{9}\right), \sqrt[3]{2}cis\left(-\frac{4\pi}{9}\right)$

(c) $cis\left(\frac{\pi}{6}\right), cis\left(\frac{5\pi}{6}\right), cis\left(-\frac{\pi}{2}\right)$ 5. (a) $\sqrt[3]{2}cis\left(\frac{\pi}{16}\right), \sqrt[3]{2}cis\left(\frac{9\pi}{16}\right), \sqrt[3]{2}cis\left(-\frac{15\pi}{16}\right), \sqrt[3]{2}cis\left(-\frac{7\pi}{16}\right)$

(b) $cis\left(\frac{\pi}{8}\right), cis\left(\frac{5\pi}{8}\right), cis\left(\frac{9\pi}{8}\right), cis\left(\frac{13\pi}{8}\right)$ (c) $i, \pm \frac{\sqrt{3}}{2} - \frac{1}{2}i$

(d) $2cis\left(-\frac{\pi}{12}\right), 2cis\left(\frac{5\pi}{12}\right), 2cis\left(\frac{11\pi}{12}\right), 2cis\left(-\frac{7\pi}{12}\right)$ (e) $2(\pm\sqrt{3}+1i), -4i$

(f) $\pm \frac{1}{2}((\sqrt{3}+1) + (\sqrt{3}-1)i)$ 6. (a) $1, -\frac{1}{2} \pm \frac{\sqrt{3}}{2}i$ 7. $-2, 1 \pm \sqrt{3}i$

EXERCISE 12.4.1

1. (a) $2n+2$ (b) $5n-2$ (c) $\frac{1}{n}$ (d) 3^n (e) n^2+1 (f) $\frac{n}{n+1}$ (g) $\frac{n+1}{n}$ (h) 2^{3-n} 2. (i) n^2+2n+2

(ii) $2n^2+n-2$ (iii) n^3-2n (iv) $\frac{20+n^2-n^4}{4}$ (v) $1+n+6n^2-n^3$

EXERCISE 12.4.2

1. (a) $\frac{n(2n^2+3n+7)}{6}$ (b) $\frac{n^2(n+1)^2}{4}$ (c) $\frac{1}{4}\left(1-\frac{1}{5^n}\right)$ (d) $n^2(2n^2-1)$ (e) $\frac{n(2n^2+9n+7)}{6}$

(f) $\frac{n}{2n+1}$ 2. $\frac{n(n+1)}{2}$ 3. $\frac{180(n-2)}{n}$ 4. $\frac{n^2+n+2}{2}$ 5. $\frac{n(n+1)(2n+1)}{6}$ 7. $2n^2-2n+1$

8. $\frac{n^4-6n^3+23n^2-18n+24}{24}$ 9. $15, \frac{n(n+1)}{2}, \frac{n(n+2)}{2}, \frac{3n(n+1)}{2}$ 12. $2n+1$

EXERCISE 13.1

1. (a) i. 14 500 ii. 2 000 (b) 305 (304.5) 2. Sample size is large but may be biased by factors such as the location of the catch. Population estimate is 5 000. 3. (a) i. 1500 ii. 120 (b) 100 (c) 1 000 4. (a), (c) numerical, (b), (d), (e) categorical 5. (a), (d) discrete, (b), (c), (e) continuous

EXERCISE 13.2

1.

218-220	221-223	224-226	227-229	230-232	233-235	236-238	239-241	242-244	245-247
1	4	4	3	6	8	9	5	7	1

2.

1.1-1.2	1.2-1.3	1.3-1.4	1.4-1.5	1.5-1.6	1.6-1.7	1.7-1.8	1.8-1.9	1.9-2.0	2.0-2.1
5	1	2	2	7	6	1	12	7	5

3. Set A Mode = 29.1 Mean = 27.2 Median = 27.85
Set B Mode = 9 Mean = 26.6 Median = 9. Set B is much more spread out than set A and although the two sets have a similar mean, they have very different mode and median.

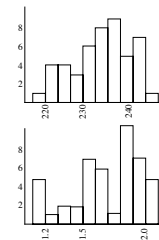

EXERCISE 13.3

1. Mode = 236-238gms; Mean = 234gms; Median = 235gms 2. Mode = 1.8-1.9gms; Mean = 1.69gms Median = 1.80gms 3. Set A Mode = 29.1 Mean = 27.2 Median = 27.85 Set B Mode = 9 Mean = 26.6 Median = 9. 4. (a) \$27522 (b) \$21025 (c) Median 5. i. \$233 300 ii. \$169 000 iii. Median 6. (a) 14.375 (b) 14.354

EXERCISE 13.4

1. (a) Sample A Mean = 1.99kg Sample B Mean = 2.00kg (b) Sample A Sample std = 0.0552kg Sample B Sample std = 0.1877kg (c) Sample A Population std = 0.0547kg Sample B Population std = 0.1858kg 2. (a) 16.4 (b) 6.83 3. Mean = 49.97 Std = 1.365

EXERCISE 13.5

1. (a) Med = 5, Q1 = 2, Q3 = 7, IQR = 5 (b) Med = 3.3, Q1 = 2.8, Q3 = 5.1, IQR = 2.3 (c) Med = 163.5, Q1 = 143, Q3 = 182, IQR = 39 (d) Med = 1.055, Q1 = 0.46, Q3 = 1.67, IQR = 1.21 (e) Med = 5143.5, Q1 = 2046, Q3 = 6252, IQR = 4206
2. (a) Med = 3, Q1 = 2, Q3 = 4, IQR = 2 (b) Med = 13, Q1 = 12, Q3 = 13, IQR = 1 (c) Med = 2, Q1 = 2, Q3 = 2.5, IQR = 0.5 (d) Med = 40, Q1 = 30, Q3 = 50, IQR = 20 (e) Med = 20, Q1 = 15, Q3 = 22.5, IQR = 7.5
3. (a) \$84.67 (b) \$148 (c) \$11 (d) Q1 = \$4.50, Q3 = \$65 IQR = \$60.50 (e) Median & IQR.
4. (a) 2.35 (b) 1.25 (c) 2 (d) Q1 = 1, Q3 = 3, IQR = 2 5. (a) \$232 (b) \$83

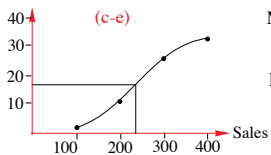

Med = \$220
Q1 = \$160
Q3 = \$310
IQR = \$150

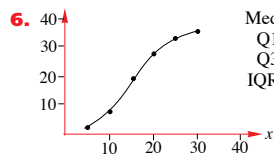

Med = 16
Q1 = 10
Q3 = 24
IQR = 14

EXERCISE 13.6

1. (a) Sample—100 randomly selected patients, population—all suffering from AIDS
(b) Sample—1000 working aged people in N.S.W, population—all working aged people in N.S.W
(c) Sample—John's I.B Higher Maths class, population—all seniors at Nappa Valley High School.
2. Discrete: a, b, d; Continuous: c, e, f, g.
3. (b)

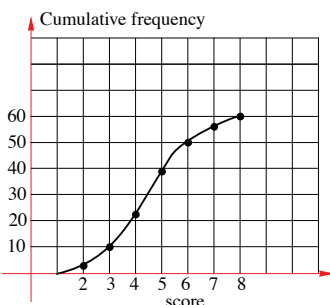
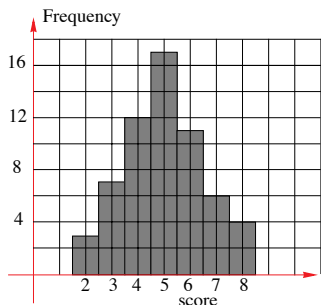

4. suggested answers only: (a) 200–224; 225–249; 250–274; ... 575–599
(b) 100–119; 120–139; ... 400–419 (c) 440–459; 460–479; ... 780–799.
5. Make use of your graphics calculator
6. (a) 16 (b) graphics calculator (c) 15.23
(d) 15.5 (e) Q1 = 14, Q3 = 17 (f) 15.87 (2dec.pl.)
7. (a) 30–34 (b) graphics calculator (c) 30.4
(d) 32 (approx)
8. (b) 215.5 (c) 216.2 9. 48.17

10. (a) Q1 ~ 35, Q3 ~ 95 (b) ~ 105 (c) 61% (d) 67.15
11. range = 19, s = 5.49 12. 5.8; 1.50 13. 17.4; $s_n = 3.12$ $s_{n-1} = 3.18$
14. (a) 6 (b) 7 (c) Q1 = 5, Q3 = 7
(d) 2 (e) 6.15 (f) 1.61
15. $s_n = 18.8$, $s_{n-1} = 19.1$ 16. 14.18

EXERCISE 14.1

1. 15 2. (a) 25 (b) 625 3. (a) 24 (b) 256 4. (a) 24 (b) 48 5. 15 6. 270 7. 120 8. 336 9. 60
10. (a) 362880 (b) 80640 (c) 1728 11. 20 12. (a) 10! (b) $2 \times 8!$ (c) i. $2 \times 9!$ ii. $8 \times 9!$ 13. 34650
14. 4200 15. 4

EXERCISE 14.2

1. 792 2. (a) 1140 (b) 171 3. 1050 4. 70 5. 2688 6. (a) 210 (b) 420 7. 24000 8. 8 9. 155
10. 5

EXERCISE 14.3

1. (a) 120 (b) 325 2. 5040 3. (a) 144 (b) 1440 4. (a) 720 (b) 240 5. 11760 6. 7056; 4606
7. (a) 840 (b) 1680 8. 190 9. 10080 10. 226800 11. (a) 715 (b) 315 (c) 665 13. ${}^n C_2$ 14. ${}^n C_4$
15. (b) 92 16. 252 17. (a) 1287 (b) 560 18. 256 19. 288 20. (a) 10080 (b) 30240 (c) 14400
21. 10080, 1080 22. 3528000 23. 720; 240 24. 103680 25. (a) 12 (b) 128 26. 2880
27. (a) 30030 (b) 37310 28. 77055 29. (a) 48 (b) 72

EXERCISE 15.1

1. (a) $\frac{2}{5}$ (b) $\frac{3}{5}$ (c) $\frac{2}{5}$ 2. (a) $\frac{2}{7}$ (b) $\frac{5}{7}$ 3. (a) $\frac{5}{26}$ (b) $\frac{21}{26}$ 4. {HH, HT, TH, TT} (a) $\frac{1}{4}$ (b) $\frac{3}{4}$
5. {HHH, HHT, HTH, THH, TTT, TTH, THT, HTT} (a) $\frac{3}{8}$ (b) $\frac{1}{2}$ (c) $\frac{1}{4}$ 6. (a) $\frac{2}{9}$ (b) $\frac{2}{9}$ (c) $\frac{2}{3}$ (d) $\frac{1}{3}$
7. (a) $\frac{1}{2}$ (b) $\frac{3}{10}$ (c) $\frac{9}{20}$ 8. (a) $\frac{11}{36}$ (b) $\frac{1}{18}$ (c) $\frac{1}{6}$ (d) $\frac{5}{36}$ 9. {GGG, GGB, GBG, BGG, BBB, BBG, BGB, GBB} (a) $\frac{1}{8}$ (b) $\frac{3}{8}$ (c) $\frac{1}{2}$ 10. (a) $\frac{1}{2}$ (b) $\frac{1}{4}$ (c) $\frac{1}{4}$ 11. (a) $\frac{3}{8}$ (b) $\frac{1}{4}$ (c) $\frac{3}{8}$ (d) $\frac{3}{4}$
12. (a) {(1, H), (2, H), (3, H), (4, H), (5, H), (6, H), (1, T), (2, T), (3, T), (4, T), (5, T), (6, T)}
(b) $\frac{1}{4}$ 13. (a) $\frac{1}{216}$ (b) $\frac{1}{8}$ (c) $\frac{3}{8}$

EXERCISE 15.2

1. (a) $\frac{1}{4}$ (b) $\frac{5}{8}$ (c) $\frac{3}{4}$ 2. (a) $\frac{1}{13}$ (b) $\frac{1}{2}$ (c) $\frac{1}{26}$ (d) $\frac{7}{13}$ 3. $\frac{9}{26}$ 4. (a) 1.0 (b) 0.3 (c) 0.5 5. (a) 0.65
(b) 0.70 (c) 0.65 6. (a) 0.95 (b) 0.05 (c) 0.80 7. (a) {TTT, TTH, THT, HTT, HHH, HHT, HTH, THH} (b) $\frac{3}{8}$ (c) $\frac{1}{2}$ (d) $\frac{1}{4}$ (e) $\frac{3}{8}$ 8. (a) $\frac{6}{25}$ (b) $\frac{6}{25}$ (c) $\frac{13}{25}$ 9. (b) $\frac{3}{4}$ (c) $\frac{1}{2}$ (d) $\frac{1}{6}$ (e) $\frac{7}{12}$
10. (a) $\frac{1}{4}$ (b) $\frac{1}{2}$ (c) $\frac{8}{13}$ (d) $\frac{7}{13}$ 11. (a) 0.1399 (b) 0.8797 (c) 0.6 12. (b) $\frac{4}{15}$ (c) $\frac{4}{15}$ (d) $\frac{11}{15}$

EXERCISE 15.3

1. (a) 0.7 (b) 0.75 (c) 0.50 (d) 0.5 2. (a) 0.5 (b) 0.83 (c) 0.10 (d) 0.90

3. (a) (b) $\frac{8}{45}$ (c) $\frac{22}{45}$ (d) $\frac{6}{11}$ 4. (a) 0.5 (b) 0.30 (c) 0.25

5. (a) (b) $\frac{1}{2}$ (c) $\frac{2}{3}$ 6. $\frac{1}{3}$ 7. (a) (b) $\frac{31}{45}$ (c) $\frac{2}{9}$ 8. $\frac{2}{3}$

9. (a) 0.88 (b) 0.42 (c) 0.6 (d) 0.28 10. (a) 0.33 (b) 0.49 (c) 0.82 (d) 0.551 11. (a) 0.22 (b) 0.985 (c) 0.8629 12. (a) 0.44 (b) 0.733 14. (a) 0.512 (b) 0.128 (c) 0.8571 15. (a) 0.2625 (b) 0.75 (c) 0.4875 (d) 0.7123 16. (a) 0.027 (b) 0.441 (c) 0.453

EXERCISE 15.4

1. (a) 0.042 (b) 0.7143 2. (a) 0.4667 (b) 0.3868 3. (a) $\frac{5}{7}$ (b) $\frac{9}{13}$ 4. $\frac{5}{9}$ 5. (b) i. $\frac{1}{40}$ ii. 0.2

6. (a) i. $\frac{2N-m}{2N}$ ii. $\frac{2(N-m)}{2N-m}$ (b) $\frac{m}{m+(N-m)2^n}$ 7. $\frac{9}{19}$ 8. a. 0.07 b. 0.3429 c. 0.30

d. 0.0282 9. a. 0.8008 b. 0.9767 c. 0.0003 10. a. 0.0464 b. 0.5819 c. 0.9969

11. a. 0.2 b. 0.08 c. 0.72 d. $\begin{bmatrix} 0.8 & 0.2 \\ 0.4 & 0.6 \end{bmatrix}$; $\begin{bmatrix} 0.72 & 0.28 \\ 0.56 & 0.44 \end{bmatrix}$ g. 0.688

EXERCISE 15.5

1. (a) $\frac{5}{126}$ (b) $\frac{5}{18}$ (c) $\frac{1}{126}$ 2. (a) $\frac{1}{5}$ (b) $\frac{1}{10}$ (c) $\frac{2}{5}$ (d) $\frac{3}{5}$ 3. (a) $\frac{72}{5525}$ (b) $\frac{1}{5525}$ (c) $\frac{1}{1201}$ 4. $\frac{2}{5}$

5. (a) $\frac{63}{143}$ (b) $\frac{133}{143}$ 6. (a) $\frac{5}{12}$ (b) $\frac{5}{33}$ (c) $\frac{5}{6}$ 7. $\frac{3}{11}$ 8. (a) $\frac{4}{13}$ (b) $\frac{9}{13}$ 9. (a) $\frac{67}{91}$ (b) $\frac{22}{91}$

10. (a) $\frac{1}{4}$ (b) $\frac{1}{28}$ (c) $\frac{5}{14}$ 11. (a) $\frac{5}{28}$ (b) $\frac{1}{28}$ 12. $\frac{6}{13}$ 13. (a) $\frac{1}{6}$ (b) $\frac{1}{4}$ 14. (a) $\frac{1}{210}$ (b) $\frac{7}{9}$

15. (a) $\frac{7}{1938}$ (b) 0.6 16. $\frac{11}{21}$

EXERCISE 16.1

1. 0.3 2. (a) 0.1 (b) i. 0.2 ii. 0.7 3. (a) $p(0) = \frac{6}{15}$, $p(1) = \frac{8}{15}$, $p(2) = \frac{1}{15}$ (c) $\frac{14}{15}$

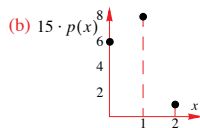

4. (a) {2, 3, 4, 5, 6, 7, 8, 9, 10, 11, 12}

(b)

x	2	3	4	5	6	7	8	9	10	11	12
p(x)	$\frac{1}{36}$	$\frac{2}{36}$	$\frac{3}{36}$	$\frac{4}{36}$	$\frac{5}{36}$	$\frac{6}{36}$	$\frac{5}{36}$	$\frac{4}{36}$	$\frac{3}{36}$	$\frac{2}{36}$	$\frac{1}{36}$

(c) $\frac{5}{36}$

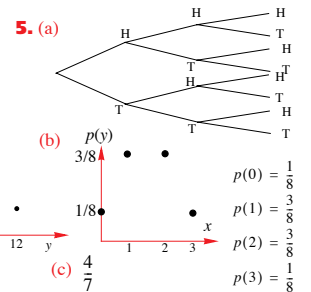
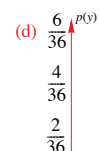

$$p(0) = \frac{1}{35} \quad p(1) = \frac{4}{35}$$

6. (a) $\frac{1}{35}$ (b) i. $p(2) = \frac{7}{35}$ $p(3) = \frac{10}{35}$ ii. $\frac{6}{7}$ 7. (a) i. 0.9048

$$p(4) = \frac{13}{35}$$

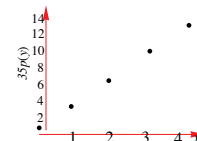

ii. 0.09048 (b) 0.0002 8. 0.3712 9. $p(0) = \frac{11}{30}$, $p(-1) = \frac{1}{2}$, $p(3) = \frac{2}{15}$ (b) i. $\frac{11}{30}$ ii. $\frac{13}{15}$

n	0	1	2
$P(N=n)$	$\frac{6}{15}$	$\frac{8}{15}$	$\frac{1}{15}$

n	1	2	3	4
$P(N=n)$	$\frac{1}{4}$	$\frac{1}{4}$	$\frac{1}{4}$	$\frac{1}{4}$

(b)

s	2	3	4	5	6	7	8
$P(S=s)$	$\frac{1}{16}$	$\frac{2}{16}$	$\frac{3}{16}$	$\frac{4}{16}$	$\frac{3}{16}$	$\frac{2}{16}$	$\frac{1}{16}$

 12. (a) 0.81 (b) 0.2439

EXERCISE 16.2

1. (a) 2.8 (b) 1.86 2. (a) 3 (b) i. 1 ii. 1 (c) i. 6 ii. 0.4 3. (a) i. 1.3 ii. 2.5 iii. -0.1 (b) i. 0.9 ii. 7.29 (c) i. $\frac{31}{60}$ ii. 0.3222 4. $\mu = \frac{2}{3}$, $\sigma^2 = 0.3556$ 5. (a) 7 (b) 5.8333 6. $np = 3 \times \frac{1}{2} = 1.5$

7. (a) $\frac{1}{25}$ (b) 2.8 (c) 1.166 8. (a) 0.1 (b) i. 0.3 ii. 1 (c) i. 0 ii. 1 iii. 2 9. 5.56

10. $p(0) = \frac{35}{120}$, $p(1) = \frac{63}{120}$, $p(2) = \frac{21}{120}$, $p(3) = \frac{1}{120}$ (b) i. 0.9 ii. 0.49 (c) $W = 3N - 3$

$E(W) = -0.3$ 11. (a) \$-1.00 (b) both the same 12. (a) 50 (b) 18 (c) 2 13. (a) 11 (b) $\frac{\sqrt{3}}{3}$ (c) -4

14. (a) 0.75 (b) 0.6339 15. (a) $E(X) = 1 - 2p$, $\text{Var}(X) = 4p(1-p)$ (b) i. $n(1-2p)$ ii. $4np(1-p)$

16.

n	0	1	2
$P(N=n)$	$\frac{28}{45}$	$\frac{16}{45}$	$\frac{1}{45}$

 $W = 21.43$ 17. (a) $a = \frac{2}{3}$, $0 \leq b \leq 1$

(b) $E(X) = \frac{b+1}{3}$, $Var(X) = \frac{1}{9}(2+7b-b^2)$ **18.** (a) $E(X) = 4$, $Var(X) = 20$

EXERCISE 16.3

- 1.** (a) 0.2322 (b) 0.1737 (c) 0.5941 **2.** (a) 0.3292 (b) 0.8683 (c) 0.2099 (d) 0.1317 **3.** (a) 0.1526 (b) 0.4812 (c) 0.5678 **4.** (a) 0.7738 (b) 3.125×10^{-7} (c) 0.9988 (d) 3×10^{-5} **5.** (a) 0.2787 (b) 0.4059 **6.** (a) 0.2610 (b) 0.9923 **7.** (a) 0.2786 (b) 0.7064 (c) 0.1061 **8.** (a) 0.1318 (b) 0.8484 (c) 0.0549 (d) 0.3296 **9.** (a) 0.2938 (b) 0.6531 (c) 0.0027 (d) 0.9726 (e) 12.86 **10.** (a) 0.0039 (b) 0.2734 (c) 0.6367 (d) 0.9648 **11.** (a) 0.3125 (b) 0.0156 (c) 0.3438 (d) 3 **12.** (a) 0.2785 (b) 0.3417 (c) 120 **13.** (a) 0.0331 (b) 0.5695 **14.** (a) 0.4305 (b) 0.9619 (c) \$720 (d) 0.2059 **15.** (a) i. 1.4 ii. 1 iii. 1.058 iv. 0.0795 v. 0.0047 (b) i. 3.04 ii. 3 iii. 1.373 iv. 0.2670 v. 0.1390 **16.** 38.23 **19.** (a) i. 0.1074 ii. 7.9×10^{-4} iii. 0.3758 (b) at least 6 **20.** (a) $\frac{4}{3}$ (b) $\frac{10}{9}$ (c) $\frac{1}{6}$ (d) $\frac{5}{288}$ **21.** (a) 20 (b) 3.4641 **22.** (a) 102.6 (b) 0.000254 **23.** (a) i. 6 ii. 2.4 (b) i. 6 ii. 3.6 **24.** 0.1797 **25.** 1.6, 1.472 **26.** (a) 0.1841 (b) \$11.93 **27.** (a) \$8 (b) \$160

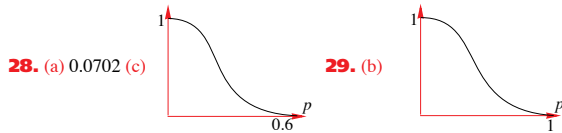

28. (a) 0.0702 (c) **29.** (b) **30.** (b) 0.8035 (c) 39.3 **31.** (a) $\frac{np - np(1-p)^{n-1}}{1 - (1-p)^n - np(1-p)^{n-1}}$, $0 < p < 1$

EXERCISE 16.4

- 1.** (a) 0.3263 (b) 0.0932 **2.** (a) 0.0015 (b) 0 (c) 0.9714 **3.** (a) 1.2 (b) 0.56 **4.** (a) 3.4848 (b) $\frac{10}{3}$ (c) 0.7071 **5.** (a) $\frac{1}{1365}$ (b) $\frac{22}{91}$ **6.** $\frac{1921}{1938}$ **7.** (a) $\frac{27}{91}$ (b) $\frac{87}{91}$ **8.** (a)

x	1	2	3	4	5
$P(X=x)$	0.0238	0.2381	0.4762	0.2381	0.0238

 (b) 3 **9.** (a) $\frac{9}{22}$ (b) $\frac{1}{22}$ **10.** (a) $\frac{46}{255}$ (b) $\frac{184}{595}$ (c) $\frac{32}{357}$ **11.** (a) $\frac{7}{22}$ (b) $\frac{37}{44}$ **12.** $\frac{49}{60}$ **13.** (a) hypergeometric **14.** $\frac{66}{91}$ **15.** (a) $\frac{1}{8}$ (b) $\frac{47}{72}$ **16.** (a) $\frac{44}{45}$ (b) 0.9999 **17.** $\frac{11}{21}$ **18.** 0.8 **19.** (a) $\frac{48}{55}$ (b) i. 0.3365 ii. 0.01066 (c) 0.9682 **20.** (a) $\frac{28}{45}$ (b) $\frac{16}{45}$ (c) $\frac{1}{45}$, 10 days beforehand (place order on 11 July)

22. (a)

x	1	2	3	4	5
$P(X=x)$	0.598	0.315	0.075	0.010	0.001

 remainder ~ 0

(b)

x	0	1	2	3	4	5	6	7	8	9	10
$P(\text{Accept})$	1	$\frac{4}{5}$	$\frac{28}{45}$	$\frac{7}{15}$	$\frac{1}{3}$	$\frac{2}{9}$	$\frac{2}{15}$	$\frac{1}{15}$	$\frac{1}{45}$	0	0

 $\sim 90\%$

EXERCISE 16.5

- 1.** (a) $P(X=x) = \frac{e^{-2}2^x}{x!}$, $x = 0, 1, 2, \dots$ (b) i. 0.1353 ii. 0.2707 iii. 0.5940 iv. 0.4557 **2.** (a) 0.0383 (b) 0.1954 **3.** (a) 0.2052 (b) 0.9179 **4.** (a) 0.2623 (b) 0.8454 **5.** (a) 0.0265 (b) 0.0007 **6.** (a) 0.1889 (b) 0.7127 **7.** (a) 0.7981 (b) 0.2019 (c) 0.1835 **8.** (a) 0.2661 (b) 0.5221 **9.** 0.1912 **10.** (a) 0.3504 (b) 0.6817 **11.** (a) 0.00127 (b) 0.0500 **12.** (a) 0.1804 (b) 0.0166 (c) 0.3233 **13.** (a) 0.8131; 0.5511 No **14.** 0.4781 **15.** (a) 0.3679 (b) 0.2642 (c) 0.2135 **16.** (a) i. p ii. $-p \ln p$ iii. $1 - p + p \ln p$ (c) 0.4785

EXERCISE 17.1

- 1.** (i) 0.6915 (ii) 0.9671 (iii) 0.9474 (iv) 0.9965 (v) 0.9756 (vi) 0.0054 (vii) 0.0287 (viii) 0.0594 (ix) 0.0073 (x) 0.8289 (xi) 0.6443 (xii) 0.0823 **2.** (i) 0.0360 (ii) 0.3759 (iii) 0.0623 (iv) 0.0564 (v) 0.0111 (vi) 0.2902 (vii) 0.7614 (viii) 0.0343 (ix) 0.6014 (x) 0.1450 (xi) 0.9206 (xii) 0.2668 (xiii) 0.7020 (xiv) 0.9132 (xv) 0.5203 (xvi) 0.8160 (xvii) 0.9388 (xviii) 0.7258

EXERCISE 17.2

- 1.** (a) 0.0228 (b) 0.9332 (c) 0.3085 (d) 0.8849 (e) 0.0668 (f) 0.9772 **2.** (a) 0.9772 (b) 0.0668 (c) 0.6915 (d) 0.1151 (e) 0.9332 (f) 0.0228 **3.** (a) 0.3413 (b) 0.1359 (c) 0.0489 **4.** (a) 0.6827 (b) 0.1359 (c) 0.3934 **5.** (a) 0.8413 (b) 0.4332 (c) 0.7734 **6.** (a) 0.1151 (b) 0.1039 (c) 0.1587 (d) 0.1587 (b) 0.6827 (c) 0.1359 **8.** (a) 0.1908 (b) 0.4754 (c) 16.88 **9.** (a) 0.1434 (b) 0.6595 **10.** (a) 0.2425 (b) 0.8413 (c) 0.5050 **11.** (a) -1.2816 (b) 0.2533 **12.** (a) 58.2243 (b) 41.7757 (c) 59.80 **13.** 39.11 **14.** 9.1660 **15.** 42% **16.** 0.7021 **17.** (i) 0.2903 (ii) 0.4583 (iii) 0.2514 **18.** 23% **19.** 0.5 **20.** 11% **21.** 5% **22.** 14% **23.** 1.8 **24.** 252 **25.** 0.1517 **26.** 0.3821 **27.** 0.22 **28.** 322 **29.** 0.1545 **30.** 7 **31.** 87 **32.** (a) i. 0.0062 ii. 0.0478 iii. 0.9460 (b) 0.0585 **33.** (a) \$5.11 (b) \$7.39 **34.** (a) 0.0062 (b) i. 0.7887 ii. 0.0324 (c) \$1472 **35.** (a) $\mu = 66.86$, $\sigma = 10.25$ (b) \$0.385 **36.** (a) $\mu = 37.2$, $\sigma = 28.2$ (b) 20 (19.9) **37.** (a) i. 0.3446 ii. 0.2347 (b) i. 0.3339 ii. 0.3852 (c) 0.9995

EXERCISE 18.1

- 1.** (a) $\frac{3}{4}$ (b) $\frac{3a}{4b}$ (c) -1 (d) 1 (e) $-\frac{15}{8}$ (f) 0 **2.** (a) 4 (b) 0.2 (c) 0.027 (d) 0.433 (e) -0.01 (f) 6.34 (g) 6.2 (h) 0 **3.** (a) 6 m/s (b) 30 m/s (c) $11 + 6h + h^2$ m/s **4.** 12 m/s **5.** $8 + 2h$ **6.** -3.49 °C/sec **7.** (a) 127π cm³/cm (b) i. 19.6667π cm³/cm ii. 1.9967π cm³/cm iii. 0.2000π cm³/cm **8.** 1.115 **9.** (a) -7.5 °C/min (b) $t = 2$ to $t = 6$ **10.** (a) 28 m (b) 14 m/s (c) average speed (d) 49 m (e) 49 m/s **11.** (a) \$1160, \$1345.6, \$1560.90, \$1810.64, \$2100.34 (b) \$220.07 per year

EXERCISE 18.2

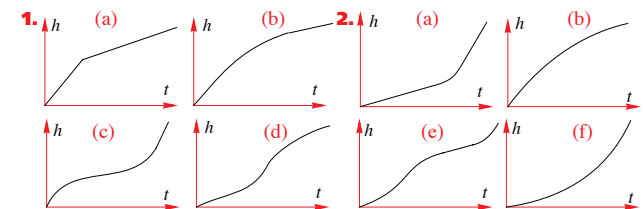

EXERCISE 18.3

1. (a) $h + 2$ (b) $4 + h$ (c) $\frac{-1}{1+h}$ (d) $3 - 3h + h^2$ 2. (a) 2 (b) 4 (c) -1 (d) 3 3. (a) $2a + h$

(b) $-(2a + h)$ (c) $(2a + 2) + h$ (d) $3a^2 + 1 + 3ah + h^2$ (e) $-(3a^2 + 3ah + h^2)$

(f) $3a^2 - 2a + (3a - 1)h + h^2$ (g) $\frac{-2}{a(a+h)}$ (h) $\frac{1}{(a-1)(a-1+h)}$ (i) $\frac{1}{\sqrt{a+h} + \sqrt{a}}$

4. (a) 1; (b) $2a + h$; $2a$ (c) $3a^2 + 3ah + h^2$; $3a^2$ (d) $4a^3 + 6a^2h + 4ah^2 + h^3$; $4a^3$

5. (a) (b) i. 3 ms^{-1} ii. 2 ms^{-1} iii. 1.2 ms^{-1} 6. (b) i. 20 cm^2 ii. 17.41 cm^2

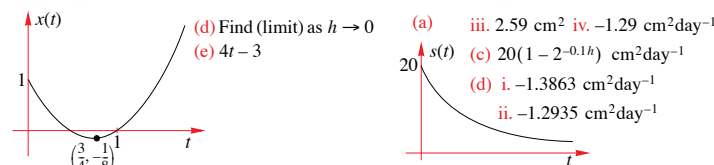

EXERCISE 18.4

1. (a) 3 (b) 8 (c) $-\frac{1}{9}$ (d) 1.39 (e) -1 (f) $\frac{17}{16}$ 2. 4.9 m (b) $4.9(h^2 + 2h)$ m (c) 9.8 m/s

3. (a) $8x$ (b) $10x$ (c) $12x^2$ (d) $15x^2$ (e) $16x^3$ (f) $20x^3$ 4. (a) $4x$ (b) -1 (c) $-1 + 3x^2$ (d) $-x^{-2}$

(e) $-2(x+1)^{-2}$ (f) $0.5x^{-1/2}$ 5. (a) 1 ms^{-1} (b) $(2-a) \text{ ms}^{-1}$

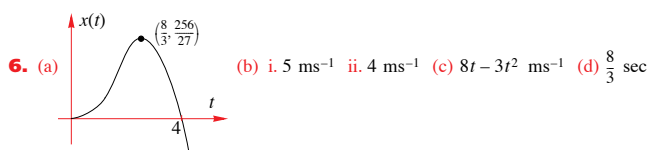

EXERCISE 19.1

1. (a) $5x^4$ (b) $9x^8$ (c) $25x^{24}$ (d) $27x^2$ (e) $-28x^6$ (f) $2x^7$ (g) $2x$ (h) $20x^3 + 2$ (i) $-15x^4 + 18x^2 - 1$

(j) $\frac{4}{3}x^3 + 10$ (k) $9x^2 - 12x$ (l) $3 + \frac{2}{3}x + 4x^3$ 2. (a) $-\frac{3}{x^4}$ (b) $\frac{3}{2}\sqrt{x}$ (c) $\frac{5}{2}\sqrt{x^3}$ (d) $\frac{1}{3\sqrt{x^2}}$ (e) $\frac{2}{\sqrt{x}}$

(f) $9\sqrt{x}$ (g) $\frac{1}{\sqrt{x}} + \frac{3}{x^2}$ (h) $\frac{3}{2}\sqrt{x} - \frac{1}{2\sqrt{x^3}}$ (i) $\frac{10}{3\sqrt{x}} - 9$ (j) $5 - \frac{1}{2\sqrt{x}} - \frac{8}{5x^3}$ (k) $\frac{4}{\sqrt{x}} - \frac{15}{x^6} + \frac{1}{2}$

(l) $-\frac{1}{2\sqrt{x^3}} - \frac{1}{\sqrt{x}} + x^2$ 3. (a) $\frac{3}{2}\sqrt{x} + \frac{1}{\sqrt{x}}$ (b) $4x^3 + 3x^2 - 1$ (c) $3x^2 + 1$ (d) $\frac{1}{x^2}$ (e) $\frac{1}{\sqrt{x^3}}$

(f) $\frac{1}{2} - \frac{1}{4\sqrt{x^3}}$ (g) -7 (h) $2x - \frac{8}{x^3}$ (i) $2x - \frac{2}{x^2} - \frac{4}{x^5}$ (j) $\frac{1}{2}\sqrt{\frac{3}{x}} + \frac{1}{6\sqrt{x^3}}$ (k) $2x - \frac{12\sqrt{x}}{5} + \frac{2}{5\sqrt{x^3}}$

(l) $-\frac{3}{2\sqrt{x}}\left(\frac{1}{x} + 1\right)\left(\frac{1}{\sqrt{x}} - \sqrt{x}\right)^2$

EXERCISE 19.2.1

1. $m_{PQ} = 4 + h$; $\lim_{h \rightarrow 0} m_{PQ} = 4$ 2. $P(1, 1)$, $Q\left(1 + h, \frac{2}{2+h}\right)$; $m_{PQ} = \frac{-1}{2+h}$

$\lim_{h \rightarrow 0} m_{PQ} = -\frac{1}{2}$ 3. -12 4. (a) 3 (b) $-\frac{1}{4}$ (c) 12 (d) 4 (e) 4 (f) $\frac{7}{6}$ (g) $-\frac{1}{12}$ (h) $\frac{53}{16}$ 5. $\pm\sqrt{\frac{8}{3}}$

6. (a) $2x - 12$ (b) -18 (c) $(8, -32)$ 7. (a) $-3x^2 + 3$ (b) 0 (c) $(\pm\sqrt{2}, \pm\sqrt{2})$ 8. (a) $\left(\pm\frac{\sqrt{2}}{2}, -\frac{1}{16}\right)$, (0, 0)

(b) $\left\{x: -\frac{1}{\sqrt{2}} < x < 0\right\} \cup \left\{x: x > \frac{1}{\sqrt{2}}\right\}$ 9. $x = \frac{1}{3}, -1$ 10. (a) -2, 6, 3 (b) -2 11. $a = 1$ $b = -8$

12. $f'(a+b) = 2(a+b) = 2a+2b$ 13. (a) $4a^2 - 2a$, $a \geq 0$ (b) $4 - \frac{1}{a}$, $a > 0$ 14. -56

EXERCISE 19.2.2

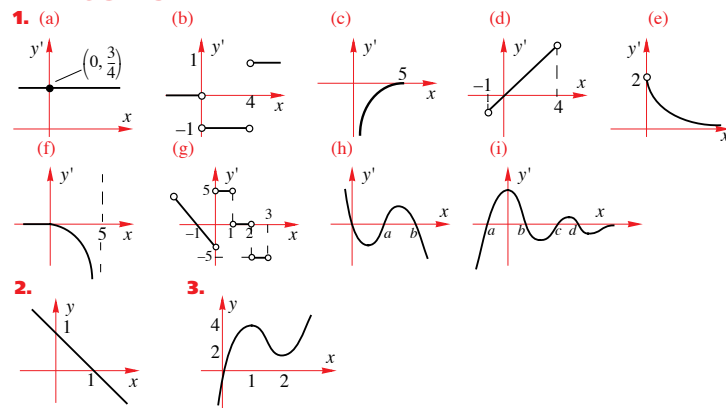

EXERCISE 19.2.3

1. (a) $48t^3 - \frac{1}{2\sqrt{t}}$ (b) $2n - \frac{2}{n^2} - \frac{4}{n^5}$ (c) $\frac{3}{2}\sqrt{r} + \frac{5}{6\sqrt{r}} - \frac{1}{\sqrt{r}}$ (d) $2\theta - \frac{9}{2}\sqrt{\theta} + 3 - \frac{1}{2\sqrt{\theta}}$ (e) $40 - 3L^2$

(f) $-\frac{100}{v^3} - 1$ (g) $6l^2 + 5$ (h) $2\pi + 8h$ (i) $4n^3 - \frac{1}{3\sqrt[3]{n^2}} + \pi$

2. (a) $\frac{8}{3t^3}$ (b) $2\pi r - \frac{20}{r^2}$ (c) $\frac{5}{2}s^{3/2} + \frac{3}{s^2}$ (d) $-\frac{6}{t^4} + \frac{2}{t^3} - \frac{1}{t^2}$ (e) $-\frac{4}{b^2} + \frac{1}{2b^{3/2}}$ (f) $3m^2 - 4m - 4$

EXERCISE 19.3

1. (a) $3x^2 - 5x^4 + 2x + 2$ (b) $6x^5 + 10x^4 + 4x^3 - 3x^2 - 2x$ (c) $-\frac{4}{x^5}$ (d) $6x^5 + 8x^3 + 2x$

2. (a) $-\frac{2}{(x-1)^2}$ (b) $\frac{1}{(x+1)^2}$ (c) $\frac{1-x^2-2x}{(x^2+1)^2}$ (d) $\frac{-(x^4+3x^2+2x)}{(x^3-1)^2}$ (e) $\frac{2x^2+2x}{(2x+1)^2}$ (f) $\frac{1}{(1-2x)^2}$

3. (a) $(\sin x + \cos x)e^x$ (b) $\ln x + 1$ (c) $e^x(2x^3 + 6x^2 + 4x + 4)$ (d) $4x^3 \cos x - x^4 \sin x$

(e) $-\sin^2 x + \cos^2 x$ (f) $2x \tan x + (1+x^2)\sec^2 x$ (g) $\frac{4}{x^3}(x \cos x - 2 \sin x)$

(h) $e^x(x \cos x + x \sin x + \sin x)$ (i) $(\ln x + 1 + x \ln x)e^x$

4. (a) $\frac{\sin x - x \cos x}{\sin^2 x}$ (b) $\frac{-[\sin x(x+1) + \cos x]}{(x+1)^2}$ (c) $\frac{e^x}{(e^x+1)^2}$ (d) $\frac{2x \cos x - \sin x}{2x\sqrt{x}}$ (e) $\frac{\ln x - 1}{(\ln x)^2}$
 (f) $\frac{(x+1) - x \ln x}{x(x+1)^2}$ (g) $\frac{x e^x + 1}{(x+1)^2}$ (h) $\frac{-2}{(\sin x - \cos x)^2}$ (i) $\frac{x^2 - x + 2x \ln x}{(x + \ln x)^2}$ **5.** (a) $-5e^{-5x} + 1$
 (b) $4 \cos 4x + 3 \sin 6x$ (c) $-\frac{1}{3}e^{-\frac{1}{3}x} - \frac{1}{x} + 18x$ (d) $25 \cos 5x + 6e^{2x}$ (e) $4 \sec^2 4x + 2e^{2x}$
 (f) $-4 \sin(4x) + 3e^{-3x}$ (g) $\frac{4}{4x+1} - 1$ (h) 0 (i) $\frac{1}{2} \cos\left(\frac{x}{2}\right) - 2 \sin 2x$ (j) $7 \cos(7x - 2)$ (k) $\frac{1}{2\sqrt{x}} - \frac{1}{x}$
 (l) $\frac{1}{x} + 6 \sin 6x$ **6.** (a) $2x \cos x^2 + 2 \sin x \cos x$ (b) $2 \sec^2 2\theta - \frac{\cos \theta}{\sin^2 \theta}$ (c) $\frac{1}{2\sqrt{x}} \cos \sqrt{x}$ (d) $\frac{1}{x^2} \sin\left(\frac{1}{x}\right)$
 (e) $-3 \sin \theta \cdot \cos^2 \theta$ (f) $e^x \cos(e^x)$ (g) $\frac{1}{x} \sec^2(\log_e x)$ (h) $\frac{-\sin 2x}{\sqrt{\cos 2x}}$ (i) $-\cos \theta \cdot \sin(\sin \theta)$
 (j) $4 \sin \theta \cdot \sec^2 \theta$ (k) $-5 \cos 5x \cdot \csc^2(5x)$ (l) $-6 \csc^2(2x)$
7. (a) $2e^{2x+1}$ (b) $-6e^{4-3x}$ (c) $-12xe^{4-3x^2}$ (d) $\frac{1}{2}\sqrt{e^x}$ (e) $\frac{1}{2\sqrt{x}}e^{\sqrt{x}}$ (f) e^{2x+4} (g) $2xe^{2x^2+4}$
 (h) $-\frac{6}{e^{3x+1}}$ (i) $(6x-6)e^{3x^2-6x+1}$ (j) $\cos(\theta)e^{\sin \theta}$ (k) $2 \sin(2\theta)e^{-\cos 2\theta}$ (l) $2x$ (m) $\frac{2e^{-x}}{(e^{-x}+1)^2}$
 (n) $3(e^x + e^{-x})(e^x - e^{-x})^2$ (o) e^{x+2} (p) $(-2x+9)e^{-x^2+9x-2}$ **8.** (a) $\frac{2x}{x^2+1}$ (b) $\frac{\cos \theta + 1}{\sin \theta + \theta}$
 (c) $\frac{e^x + e^{-x}}{e^x - e^{-x}}$ (d) $-\frac{1}{x+1}$ (e) $\frac{3}{x}(\ln x)^2$ (f) $\frac{1}{2x\sqrt{\ln x}}$ (g) $\frac{1}{2(x-1)}$ (h) $\frac{-3x^2}{1-x^3}$ (i) $-\frac{1}{2(x+2)}$
 (j) $\frac{-2 \sin x \cos x}{\cos^2 x + 1}$ (k) $\frac{1}{x} + \cot x$ (l) $\frac{1}{x} + \tan x$
9. (a) $\ln(x^3 + 2) + \frac{3x^3}{x^3+2}$ (b) $\frac{\sin^2 x}{2\sqrt{x}} + 2\sqrt{x} \sin x \cos x$ (c) $-\frac{1}{\sqrt{\theta}} \sin \sqrt{\theta} \cdot \cos \sqrt{\theta}$
 (d) $(3x^2 - 4x^4)e^{-2x^2+3}$ (e) $-(\ln x + 1) \sin(x \ln x)$ (f) $\frac{1}{x \ln x}$
 (g) $\frac{(2x-4) \cdot \sin(x^2) - 2x \cdot \cos(x^2)(x^2-4x)}{(\sin x^2)^2}$ (h) $\frac{10(\ln(10x+1)-1)}{[\ln(10x+1)]^2}$
 (i) $(\cos 2x - 2 \sin 2x)e^{x-1}$ (j) $2x \ln(\sin 4x) + 4x^2 \cot 4x$ (k) $(\cos \sqrt{x} - \sin \sqrt{x})\frac{1}{2\sqrt{x}}e^{-\sqrt{x}}$
 (l) $-(2 \sin x + 2x \cos x) \cdot \sin(2x \sin x)$ (m) $\frac{e^{5x+2}(9-20x)}{(1-4x)^2}$ (n) $\frac{\cos^2 \theta + \sin^2 \theta \ln(\sin \theta)}{\sin \theta \cos^2 \theta}$
 (o) $\frac{x+2}{2(x+1)\sqrt{x+1}}$ (p) $\frac{2x^2+2}{\sqrt{x^2+2}}$ (q) $\frac{10x^3+9x^2+4x+3}{3(x+1)^{2/3}}$ (r) $\frac{3x^2(3x^3+1)}{2\sqrt{x^3+1}}$
 (s) $\frac{2}{x^2+1} - \frac{1}{x^2} \ln(x^2+1)$ (t) $\frac{2}{x(x+2)}$ (u) $\frac{2-x}{2x^2\sqrt{x-1}}$ (v) $\frac{-x^2+x-9}{\sqrt{x^2+9}} \cdot e^{-x}$ (w) $\frac{7x^3-12x^2-8}{2\sqrt{2-x}}$
 (x) $nx^{n-1} \ln(x^n-1) + \frac{nx^{2n-1}}{x^n-1}$ **10.** $x = 1$ **11.** 0 **12.** 0 **13.** 1 **14.** $-2e$ **15.** (a) $\cos^2 x - \sin^2 x$
 (b) $\frac{\pi}{180} \cos x^\circ$ (c) $-\frac{\pi}{180} \sin x^\circ$ **16.** (b) i. $2x \sin x \cos x + x^2 \cos^2 x - x^2 \sin^2 x$

ii. $e^{-x^3}(2 \cos 2x \ln \cos x - 3x^2 \sin 2x \ln \cos x - \sin 2x \tan x)$ **17.** (a) i. $-\frac{3}{x}(\ln x)^2$ ii. $-\frac{3x^2}{1-x^3}$
 (b) i. $-2e^{-2x} \cdot \cos(e^{-2x})$ ii. $-2x \cos x^2 \cdot e^{-\sin x^2}$ **18.** $-\frac{1}{5}k$ **19.** $x = a, b, \frac{mb+na}{m+n}$
20. $\{\theta: n \tan \theta^m \cdot \tan \theta^n = m \theta^{m-n}\}$ **21.** (a) $-4 \csc(4x)$ (b) $2 \sec(2x) \tan(2x)$
 (c) $3 \cot(3x) \csc(3x)$ (d) $-3 \sin(3x)$ (e) $\csc^2\left(\frac{\pi}{4} - x\right)$ (f) $-2 \sec(2x) \tan(2x)$
22. (a) $2x \sec(x^2) \tan(x^2)$ (b) $\sec^2 x$ (c) $\tan x$ (d) $-3 \cot^2 x \csc^2 x$ (e) $x \cos x + \sin x$
 (f) $-2 \cot x \csc^2 x$ (g) $4x^3 \csc(4x) - 4x^4 \cot(4x) \csc(4x)$ (h) $2 \cot x \sec^2(2x) - \csc^2 x \tan(2x)$
 (i) $\frac{\sec x \tan x - \sin x}{2\sqrt{\cos x + \sec x}}$ **23.** (a) $e^{\sec x} \sec x \tan x$ (b) $e^x \sec(e^x) \tan(e^x)$
 (c) $e^x \sec(x) + e^x \sec(x) \tan(x)$ (d) $\frac{-\csc^2(\log x)}{x}$ (e) $-5 \csc(5x) \sec(5x)$
 (f) $\frac{\cot(x)}{x} - \csc^2(x) \log x$ (g) $-\cos x \cot(\sin x) \csc(\sin x)$ (h) $-\cos(\csc x) \cot x \csc x$ (i) 0

EXERCISE 19.4

1. (a) $\frac{2}{4x^2+1}$ (b) $\frac{1}{\sqrt{9-x^2}}$ (c) $\frac{-2}{\sqrt{1-4x^2}}$ (d) $\frac{4}{\sqrt{1-16x^2}}$ (e) $\frac{2}{x^2+4}$ (f) $\frac{1}{\sqrt{2x-x^2}}$ (g) $\frac{-1}{\sqrt{16-x^2}}$
 (h) $\frac{1}{\sqrt{4-(x+1)^2}}$ (i) $\frac{1}{(4-x)^2+1}$ (j) $\frac{-1}{\sqrt{4x-x^2}}$ (k) $\frac{6}{4x^2+9}$ (l) $\frac{-1}{\sqrt{-x^2+x+2}}$
2. (a) $\frac{2x}{x^4+1}$ (b) $\frac{1}{2\sqrt{x-x^2}}$ (c) $\frac{1}{2\sqrt{x^3-x^2}}$ (d) $\frac{-\sin x}{\sqrt{1-\cos^2 x}} = \begin{cases} -1 & \text{if } \sin x > 0 \\ 1 & \text{if } \sin x < 0 \end{cases}$ (e) $\frac{1}{2x\sqrt{x-1}}$
 (f) $\frac{1}{\sqrt{1-x^2} \sin^{-1} x}$ (g) $\frac{e^x}{1+e^{2x}}$ (h) $\frac{1}{\sqrt{e^{2x}-1}}$ (i) $\frac{e^{\arcsin x}}{\sqrt{1-x^2}}$ (j) $\frac{-4}{(4x^2+1)[\tan^{-1}(2x)]^2}$
 (k) $\frac{-1}{\sqrt{1-x^2}(\sin^{-1}(x))^{3/2}}$ (l) $\frac{2}{\sqrt{1-x^2}(\cos^{-1}(x))^3}$ (m) $\frac{-4x}{\sqrt{1-4x^2}}$ (n) $\frac{-4x}{\sqrt{1-4x^2}}$ (o) $\frac{-1}{x^2\sqrt{1-x^2}}$
3. (a) $\tan^{-1} x + \frac{x}{1+x^2}$ (b) $\frac{x - \sqrt{1-x^2} \sin^{-1} x}{x^2\sqrt{1-x^2}}$ (c) $\frac{x + \sqrt{1-x^2} \cos^{-1} x}{(\cos^{-1} x)^2\sqrt{1-x^2}}$
 (d) $\frac{-2x^2 \tan^{-1} x + x - 2 \tan^{-1} x}{x^3(x^2+1)}$ (e) $\frac{2x^2 \log x + \sqrt{1-x^2} \sin^{-1} x}{x\sqrt{1-x^4}}$ (f) $\frac{-\sqrt{1-x} \cos^{-1} \sqrt{x} - \sqrt{x}}{2x^{3/2}\sqrt{1-x}}$
 (g) $e^x \tan^{-1}(e^x) + \frac{e^{2x}}{1+e^{2x}}$ (h) $2x \tan^{-1}\left(\frac{x}{2}\right) + 2$ (i) $1 - \frac{x}{\sqrt{4-x^2}} \sin^{-1}\left(\frac{x}{2}\right)$ **4.** 0, $k = \frac{\pi}{2}$
6. (b) $k = \frac{\pi}{2}$
7. (a) $f(x) = \frac{-\pi}{x\sqrt{x^2-\pi^2}}, x > \pi$ and $\frac{\pi}{x\sqrt{x^2-\pi^2}}, x < -\pi$; $\text{dom}(f) =]-\infty, -\pi[\cup]\pi, \infty[$
 (b) $f(x) = \frac{1}{x\sqrt{2x-1}}, x > \frac{1}{2}$; $\text{dom}(f') = \left] \frac{1}{2}, \infty \right[$, $\text{dom}(f) = \left] \frac{1}{2}, \infty \right[$
 (c) $f(x) = \frac{1}{\sqrt{1-x^2}} \text{Cos}^{-1}\left(\frac{x}{2}\right) - \frac{1}{\sqrt{4-x^2}} \text{Sin}^{-1}(x), -1 < x < 1$; $\text{dom}(f) = [-1, 1]$

- (d) $f(x) = -\frac{2}{x^2+1}, x > 0$ and $\frac{2}{x^2+1}, x < 0$; $\text{dom}(f) =]-\infty, \infty[$
 (e) $f(x) = \frac{a}{\sqrt{1-a^2x^2}}, |x| < \frac{1}{a}$; $\text{dom}(f) = \left[-\frac{1}{a}, \frac{1}{a}\right]$
 (f) $f(x) = \frac{2}{\sqrt{1-x^2}}, -\frac{1}{\sqrt{2}} < x < \frac{1}{\sqrt{2}}$ and $f(x) = \frac{-2}{\sqrt{1-x^2}}, -1 < x < -\frac{1}{\sqrt{2}}$ or $\frac{1}{\sqrt{2}} < x < 1$;
 $\text{dom}(f) = [-1, 1]$
 (g) $f(x) = \frac{2}{x^2+1}, x > 0$ and $\frac{-2}{x^2+1}, x < 0$; $\text{dom}(f) =]-\infty, \infty[$
 (h) $f(x) = \frac{2}{x^2+1}, |x| < 1$ and $\frac{-2}{x^2+1}, |x| > 1$; $\text{dom}(f) =]-\infty, \infty[$
 8. (a) $\frac{nx^{n-1}}{1+x^{2n}} + \frac{n}{1+x^2}(\arctan x)^{n-1}$ (b) 0 (c) $2\sqrt{1-x^2}$ (d) $\frac{1}{2\sqrt{(a-x)(x-b)}}$ (e) $\frac{1}{2(1+x^2)}$
 (f) $\frac{1}{x^2+1}$ 9. (a) $x \geq 0$ (b) $\frac{-1}{(x+1)\sqrt{x}}, x > 0$

EXERCISE 19.5

1. (a) $(\ln 4)4^x$ (b) $(\ln 3)3^x$ (c) $(\ln 8)8^x$ (d) $3(\ln 5)5^x$ (e) $7(\ln 6)6^x$ (f) $2(\ln 10)10^x$
 (g) $(\ln 6)6^{x-2}$ (h) $3(\ln 2)2^{3x+1}$ (i) $-5(\ln 7)7^{3-x}$ 2. (a) $x(\ln 3)3^x + 3^x$
 (b) $4\cos(2x)2^x + 2(\ln 2)\sin(2x)2^x$ (c) $\ln(5)5^x e^{-x} - 5^x e^{-x}$ (d) $2x8^{-x} - \ln(8)8^{-x}x^2$
 (e) $\frac{(1+4^x) - (x+2)\ln(4)4^x}{(1+4^x)^2}$ (f) $-\sin x 5^x + \ln(5)5^x \cos x$ 3. (a) $\frac{1}{(\ln 5)^x}$ (b) $\frac{1}{(\ln 10)^x}$
 (c) $\frac{1}{(\ln 4)^x}$ (d) $\frac{1}{(\ln 9)(x+1)}$ (e) $\frac{2x}{(\ln 2)(x^2+1)}$ (f) $\frac{1}{2(\ln 5)(x-5)}$ (g) $\log_2 x + \frac{1}{\ln 2}$
 (h) $(\ln 3)3^x \log_3 x + \frac{3^x}{(\ln 3)x}$ (i) $(\ln a)a^x \log_a x + \frac{a^x}{(\ln a)x}$ (j) $\frac{(\ln a)^2 x a^x \log_a x - a^x}{(\ln a)x(\log_a x)^2}$
 (k) $\frac{(\ln(10))\log_{10}(x+1) - 1}{\ln(10)(\log_{10}(x+1))^2}$ (l) $\frac{(\ln(2))2\log_2 x - 2}{\ln(2)(\log_2 x)^2}$ 4. $\frac{1}{\ln 2}$ 5. 0, $-\frac{2}{\ln 2}$ 6. $\frac{1 - \ln 3}{3}$
 7. $\pi 2^{-\pi} \sqrt{3} + \frac{\sqrt{3}\pi \ln \pi}{2}$ 8. 1.25 9. (a) $20 + 10 \ln 10$ (b) $(\ln 4)\cos(1)$ (c) $\frac{1}{2}$ (d) $10 - \frac{10}{\ln 10}$
 10. (a) $4 \times 5^{4x+1} \ln 5$ (b) $3^{x-x^3}(1-3x^2)\ln 3$ (c) $2(10^{2x-3})\ln 10$ (d) $9\sqrt{x-x}\left(\frac{1}{2\sqrt{x}} - 1\right)\ln 9$
 (e) $-2\cos(2x) + 1 \ln 2 \sin 2x$ (f) $\frac{-4\sqrt{\cos 2x} \ln 4 \sin 2x}{\sqrt{\cos 2x}}$ (g) $2^x \cos 2^x \ln 2$ (h) $2^{\sin x} \cos x \ln 2$
 (i) $-7\left(\frac{1}{x} - 2x\right)(2+x^2)\ln 7$ 11. (a) $\frac{2\cot 2x}{\ln 2}$ (b) $\frac{x}{(x^2-1)\ln 5}$ (c) $\frac{1}{2(\sqrt{x}-10)\sqrt{x}\ln 10}$
 (d) $\frac{-4\sec^2 2x}{\ln 2(4-2\tan 2x)}$ (e) $\frac{1}{2\sqrt{x-x^2}\sin^{-1}\sqrt{x}\ln 2}$ (f) $\frac{-1}{((1-x^2)+1)\tan^{-1}(1-x)\ln 3}$

- (g) $\frac{3x^2}{(x^3-3)\ln 3}$ (h) $\frac{-1}{2(2-x)\ln 2}$ (i) $-\frac{1}{2\ln 10} \tan\left(\frac{x}{2} - 2\right)$ 12. (a) $x^x(\ln x + 1)$
 (b) $x^{\sin x}(\cos x \ln x + \frac{\sin x}{x})$ (c) $(1 - \ln x)x^{\frac{1}{x}-2}$ (d) $2\ln(x)x^{\ln x-1}$

EXERCISE 19.6

1. i. $20x^3$ ii. $48(1+2x)^2$ iii. $\frac{2}{x^3}$ iv. $\frac{2}{(1+x)^3}$ v. 2 vi. $\frac{6}{(x-2)^3}$ vii. $\frac{42}{x^8}$
 viii. $24(1-2x)$ ix. $-\frac{1}{x^2}$ x. $-\frac{2(x^2+1)}{(1-x^2)^2}$ xi. $-16\sin 4\theta$ xii. $2\cos x - x \sin x$
 xiii. $6x^2 \cos x + 6x \sin x - x^3 \sin x$ xiv. $\frac{1}{x}$ xv. $\frac{10}{(2x+3)^3}$ xvi. $6xe^{2x} + 12x^2e^{2x} + 4x^3e^{2x}$
 xvii. $\frac{8\sin 4x - 15\cos 4x}{e^x}$ xviii. $2\cos x^2 - 4x^2 \sin x^2$ xix. $\frac{-48(x^2+2x^5)}{(4x^3-1)^3}$ xx. $\frac{10}{(x-3)^3}$
 2. (a) $\frac{-2x}{(x^2+1)^2}$ (b) $\frac{x}{(1-x^2)^{3/2}}$ (c) $\frac{-x}{(1-x^2)^{3/2}}$ (d) $\frac{2}{(x^2+1)^2}$ (e) $\frac{2x-1}{4(x-x^2)^{3/2}}$ (f) $\frac{2x-3x^2}{4\sqrt{(x^3-x^2)^3}}$
 (g) $\frac{2\arctan(x)}{x^3} - \frac{1}{x^2(1+x^2)} - \frac{1+3x^2}{(x+x^3)^2}$ (h) $\frac{1}{\sqrt{4x-x^3}} + \frac{x^{3/2}}{2(4-x^2)^{3/2}} - \frac{1}{4}\left[\text{Sin}^{-1}\left(\frac{x}{2}\right)\right]x^{-3/2}$
 (i) $\frac{e^x(-x+2e^{2x}-2)}{(e^{2x}-1)\sqrt{1-e^{2x}}}$ 3. $\frac{6\ln x - 5}{x^4}, \frac{n^2 \ln x + n \ln x - 2n - 1}{x^{n+2}}$
 4. $f(x) = -\frac{1}{(x+1)^2}, f'(x) = \frac{2}{(x+1)^3}, f^{(iii)}(x) = -\frac{6}{(x+1)^4}, f^{(iv)}(x) = \frac{24}{(x+1)^5}$
 $f^{(v)}(x) = -\frac{120}{(x+1)^6}, \dots, f^{(n)}(x) = (-1)^n \frac{n!}{(x+1)^{n+1}}$
 5. $f(x) = \left(\frac{x+1}{x-1}\right)^n \Rightarrow f'(x) = \frac{4n(n+x)(x+1)^n}{(x^2-1)^2(x-1)}$ 7. (a) $a^n e^{ax}$ (b) $\frac{(-1)^n 2^n n!}{(2x+1)^{n+1}}$
 (c) $n = 2k: y^{(n)}(x) = (-1)^k a^{2k} \sin(ax+b), k = 1, 2, \dots$
 $n = 2k-1: y^{(n)}(x) = (-1)^k a^{2k-1} \cos(ax+b), k = 1, 2, \dots$ 8. (a) $2 + \frac{1}{8\sqrt{2}}$ (b) $\frac{3+\pi}{2}$
 9. -1 10. $[0, 1.0768[\cup]3.6436, 2\pi]$

EXERCISE 19.7.1

1. (a) $-2x$ (b) $\frac{x}{y}$ (c) $\frac{1}{x^3 y}$ (d) $-\frac{y}{x+1}$ (e) $-\frac{ye^x}{1+e^x}$ (f) $\frac{\sin x - y}{x}$ (g) $-y$ (h) $\frac{1-3x^4 y}{x^5}$
 (i) $\frac{y \cos x + 2}{\sin x}$ (j) -1 (k) $\frac{4x^3}{3y^2+1}$ (l) $\sqrt{x+y} - 1$ 2. (1, 5), 0
 4. $\left(\frac{3-2\sqrt{10.6}}{2}, \frac{80+4\sqrt{265}}{40}\right), \left(\frac{3+2\sqrt{10.6}}{2}, \frac{80-4\sqrt{265}}{40}\right)$ 5. (a) $y = \frac{x \pm \sqrt{5x^2-80}}{2}$
 (c) $\frac{dy}{dx} = \frac{2x+y}{x^2-y}$ (d) $\frac{5x \pm \sqrt{5x^2-80}}{2\sqrt{5x^2-80}}$ (e) Hyperbola. 6. (a) $\text{Dom} = \text{Ran} = [-2, 2]$ (b) $\frac{x^3}{y^3}$
 (c) $-\frac{x^3}{(\sqrt[4]{16-x^4})^3}$ (d) small (e) $\text{dom} = \text{ran} = [-k, k]$ (f) $\frac{dy}{dx} = -\frac{x^{2n-1}}{y^{2n-1}}$ 7. (a) $\frac{-v}{p\gamma}$

- (b) $\frac{n(m-1)x^{m-2}}{m(n+1)y^n}$ **8.** (a) $\frac{1}{11}$ (b) -1 **9.** (a) $\frac{y}{xy-x}$ (b) $\frac{(1+y^2)(\tan^{-1}y-1)}{1-x+y^2}$
- 10.** (a) undefined (b) At (0.8042, 0.5), grad = 1.32; at (0.0646, 0.5), grad = 3.74

EXERCISE 19.7.2

- 1. i.** $\frac{dy}{dx} = -\frac{5}{x^2}, \frac{d^2y}{dx^2} = \frac{10}{x^3}$ **ii.** $\frac{dy}{dx} = \frac{2x^3 + 18x^2}{(x+6)^2}, \frac{d^2y}{dx^2} = \frac{2x^3 + 36x^2 + 216x}{(x+6)^3}$
- iii.** $\frac{dy}{dx} = \frac{x}{y^2}, \frac{d^2y}{dx^2} = -\frac{4}{y^3}$ **iv.** $\frac{dy}{dx} = -\frac{1}{3e^{3y}}, \frac{d^2y}{dx^2} = -\frac{1}{3e^{6y}}$
- v.** $\frac{dy}{dx} = \frac{2\cos 2x}{\cos y}, \frac{d^2y}{dx^2} = -\frac{4\sin 2x}{\cos y} + \frac{4\cos^2 2x \tan y}{\cos^2 y}$ **vi.** $\frac{dy}{dx} = -\sqrt{\frac{y}{x}}, \frac{d^2y}{dx^2} = \frac{x + \sqrt{xy}}{2x^2}$
- vii.** $\frac{dy}{dx} = \frac{x+3y}{3x+y}, \frac{d^2y}{dx^2} = \frac{8x^2 + 48xy + 8y^2}{(3x+y)^3}$ **viii.** $\frac{dy}{dx} = -\frac{y}{x^2}, \frac{d^2y}{dx^2} = \frac{2y}{x^2}$
- 2. ii.** -3 **iii.** 2 (iv) **3. ii.** -1 **iii.** 10 **iv.** **4. i.** Dom [0,6] Ran [-4,2]
- ii.** $\frac{dy}{dx} = \frac{3-x}{y+1}, \frac{d^2y}{dx^2} = -\frac{9}{(y+1)^3}$ **5.** $\frac{7}{a}$

EXERCISE 20.1

- 1.** (a) $y = 7x - 10$ (b) $y = -4x + 4$ (c) $4y = x + 5$ (d) $16y = -x + 21$ (e) $4y = x + 1$ (f) $4y = x + 2$
 (g) $y = 28x - 48$ (h) $y = 4$ **2.** (a) $7y = -x + 30$ (b) $4y = x - 1$ (c) $y = -4x + 14$ (d) $y = 16x - 79$
 (e) $2y = 9 - 8x$ (f) $y = -4x + 9$ (g) $28y = -x + 226$ (h) $x = 2$ **3.** (a) $y = 2e^x - e$ (b) $y = e$ (c) $y = \pi$
 (d) $y = -x$ (e) $y = x$ (f) $ey = (2e-1)x - e^2 + 2e - 1$ (g) $y = ex$ (h) $y = 2x + 1$
- 4.** (a) $2ey = -x + 2e^2 + 1$ (b) $x = 1$ (c) $x = \pi$ (d) $y = x - 2\pi$ (e) $y = -x + \pi$
 (f) $(2e-1)y = -ex + 3e^2 - 4e + 1$ (g) $ey = -x$ (h) $2y = -x + 2$ **5.** A: $y = 28x - 44$,
 B: $y = -28x - 44$, Isosceles. $z = (0, a^2 - 3a^4)$ **6.** 2 sq. units, $y = 2x = 1$ **7.** $4y = 3x$
- 8.** $by = \sqrt{a^2 - b^2}x$ **9.** $y = 4x - 9$ **10.** $y = \log_e 4$ **11.** $8y = 4(\pi + 2)x - \pi^2$;
 $4(\pi + 2)y = -8x + 4\pi + \pi^2$ **12.** A: $y = -8x + 32$, B: $y = 6x + 25, (\frac{1}{2}, 28)$ **13.** $y = -x$, Tangents:
 $y = \frac{1}{2}, y = -\frac{1}{2} (\frac{1}{2}, \frac{1}{2}), (\frac{1}{2}, -\frac{1}{2})$ tangent and normal meet at (0.5, -0.5)
- 14.** (a) $y = 3x - 7$ (b) $Q = (2, -1)$ **15.** $m = -2, n = 5$ **16.** (a) $y = 4x - 2$ (b) $37y = 26x + 70$
 (c) $16y = x + 65$ (d) $y = \frac{4}{\pi} + \frac{\pi^2}{4(\pi-2)} - \frac{\pi^2}{4(\pi-2)}x$ (e) $5y = 6x - 1$
- 17.** (a) $y = 1$ (b) At (1, 2) $y = 2$; At (-1, -2) $y = -2$ **18.** (a) $l_1: 3y = -2x + 1, l_2: 2y = 3x + 5$
 (b) $l_1: 2y = x, l_2: y = -2x + 5$ (c) $l_1: 6y = x + 16, l_2: y = -6x + 15$ **19.** $(\frac{2}{3}, 1)$

EXERCISE 20.2

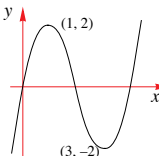
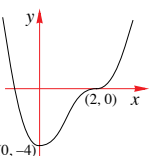
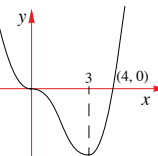
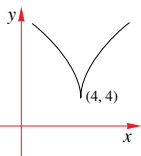
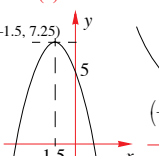
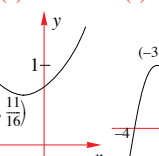
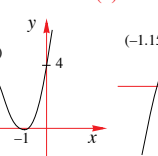
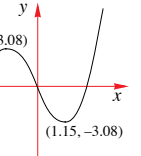
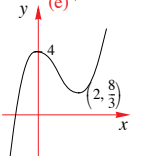
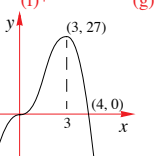
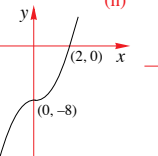
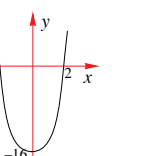
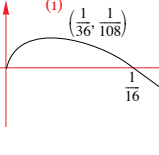
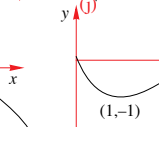
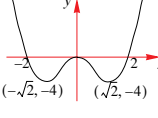
- 1.** (a)  (b)  (c)  (d) 
- 2.** (a) max at (1, 4) (b) min at $(-\frac{9}{2}, -\frac{81}{4})$ (c) min at (3, -45) max (-3, 63) (d) max at (0, 8),
 min at (4, -24) (e) max at (1, 8), min at (-3, -24) (f) min at $(\frac{1 + \sqrt{13}}{3}, \frac{70 - 26\sqrt{13}}{27})$,
 max at $(\frac{1 - \sqrt{13}}{3}, \frac{70 + 26\sqrt{13}}{27})$ (g) min at (1, -1) (h) max at (0, 16), min at (2, 0),
 min at (-2, 0) (i) min at (1, 0) max at $(-\frac{1}{3}, \frac{32}{27})$ (j) min at $(\frac{4}{9}, -\frac{4}{27})$ (k) min at (2, 4),
 max at (-2, -4) (l) min at (1, 2), min at (-1, 2)
- 3.** (a)  (b)  (c)  (d) 
- (e)  (f)  (g)  (h) 
- (i)  (j) 
- 4.** min at (1, -3), max at (-3, 29), non-stationary infl (-1, 13) **5.** 
- 6.** (a) i. $(\cos x - \sin x)e^{-x}$ ii. $-2\cos x \cdot e^{-x}$ (b) i. $\frac{\pi}{4}, \frac{5\pi}{4}$ ii. $\frac{\pi}{2}, \frac{3\pi}{2}$ (c) Inf. $(\frac{\pi}{2}, e^{-\frac{\pi}{2}})$ $(\frac{3\pi}{2}, -e^{-\frac{3\pi}{2}})$

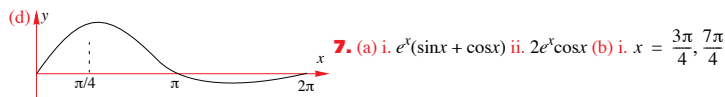

ii. $x = \frac{\pi}{2}, \frac{3\pi}{2}$ (c) st. pts. $(\frac{3\pi}{4}, \frac{1}{\sqrt{2}}e^{\frac{3\pi}{4}}), (\frac{7\pi}{4}, -\frac{1}{\sqrt{2}}e^{\frac{7\pi}{4}})$ Infl. pts. $(\frac{\pi}{2}, e^{\frac{\pi}{2}}), (\frac{3\pi}{2}, -e^{\frac{3\pi}{2}})$

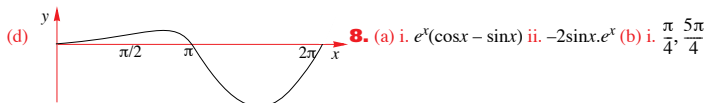

ii. $0, \pi, 2\pi$ (c) st. pts. $(\frac{\pi}{4}, \frac{1}{\sqrt{2}}e^{\frac{\pi}{4}}), (\frac{5\pi}{4}, -\frac{1}{\sqrt{2}}e^{\frac{5\pi}{4}})$ Inf. pts. $(0, 1), (\pi, -e^\pi), (2\pi, e^{2\pi})$

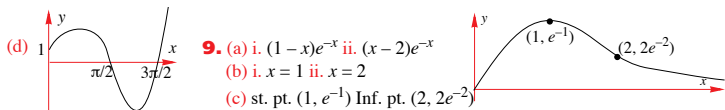

- 10.** (a) 8 (b) 0 (c) 4 (d) $27\sqrt[3]{9} \approx 56.16$ **11.** i. min value -82 . ii. max value 26
12. (a) A i. Yes ii. non-stationary pt of inflect. B. i. Yes ii. Stationary point (local/global min)
 C. i. Yes ii. non-stationary pt of inflect.
 (b) A. i. No ii. Local/global max B. i. No. ii. Local/global min C. i. Yes ii. Stationary point (local max)
 (c) A. i. Yes ii. Stationary point (local/global max) B. i. Yes ii. Stationary point (local min)
 C. i. Yes ii. non-stationary pt of inflect.
 (d) A. i. Yes ii. Stationary pt (local/global max) B. i. No ii. Local min
 C. i. Yes ii. Stationary point (local max)
 (e) A. i. No ii. Cusp (local min) B. i. Yes ii. Stationary pt of inflect C. i. Yes ii. Stationary point (local max)
 (f) A. i. Yes ii. Stationary point (local/global max) B. i. Yes ii. Stationary point (local/global min) C. i. No ii. Tangent parallel to y-axis.
13. (a) i. A ii. B iii. C (b) i. C ii. B iii. A

14. i. ii. iii. **15.** $y = x^3 + 6x^2 + 9x + 4$

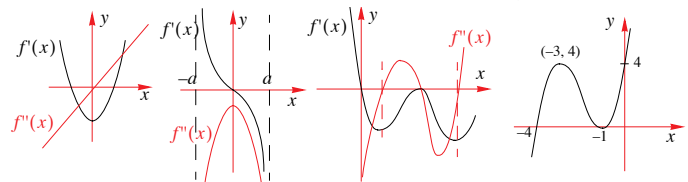

16. $f(x) = \frac{1}{3}x^3 - x^2 - 3x - 6$ **17.** $f(x) = 3x^5 - 20x^3$

18.

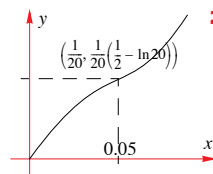

19. $m = -0.5, n = 1.5$

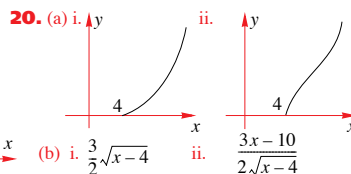

21. $a = 2, b = -3, c = 0$ **22.** Stationary points: local min at $(-1, 0)$ and local max at $(1, 4e^{-1})$.
 inflection. pts are: $(1 + \sqrt{2}, (6 + 4\sqrt{2})e^{-(1 + \sqrt{2})})$ and $(1 - \sqrt{2}, (6 - 4\sqrt{2})e^{-(1 - \sqrt{2})})$

23. Absolute min at $\sim (\frac{-3 + \sqrt{13}}{2}, -2.1733)$, Local max at $\sim (\frac{-3 - \sqrt{13}}{2}, 0.2062)$

Inflection pts at $\sim (-0.4384, -1.4489)$ and $(-4.5615, 0.1488)$

24. - 27. are left as questions for classroom discussion.

28. $a = 1, b = -12,$
 $c = 45, d = -34$

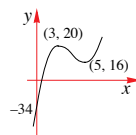

29. (b) $b = 1$

(c) $a = \frac{1}{\sqrt{2}}$

(d) $f(x) = \frac{1}{\sqrt{2}}xe^{-x^2}$

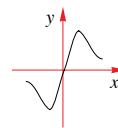

30. (a) 2.7983, 6.1212, 9.3179 (b) Make use of graphics calculator to verify your sketch.

EXERCISE 20.3

1. (a) L.min at $x = \frac{4}{\sqrt{3}}$, L.max at $x = -\frac{4}{\sqrt{3}}$ (b) L.max at $x = 0$, L.min at $x = \pm 1$

(c) L.max at $x = 0.25$ (d) L.max at $x = 1$ (e) none (f) L.max at $x = 0.5$, L.min at $x = 1, 0$

(g) L.max at $x = 1$, L.min at $x = -1$ (h) none **2.** (a) max = 120, min = $-\frac{128}{3\sqrt{3}}$ (b) max = 224,

min = -1 (c) max = 0.5, min = 0 (d) max = 1, min = 0.

3.

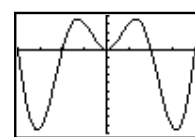
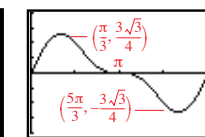
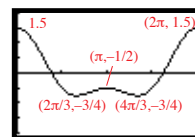

6. (a) L.min at $(1, 2)$; Infl. pt at $(3, \sqrt{3} + \frac{1}{3}\sqrt{3})$ (b) L.min at $(1, 2)$; L.max at $(-3, -6)$ (c) none

7.

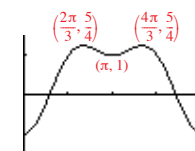

For **Q.8. - Q.11** verify your graphs with graphics calculator

8. (a) Global. min at $(0, 0)$; local max at $(2, 4e^{-2})$

Infl. pts $(2 - \sqrt{2}, (6 - 4\sqrt{2})e^{-(2 - \sqrt{2})})$

$(2 + \sqrt{2}, (6 + 4\sqrt{2})e^{-(2 + \sqrt{2})})$

(b) Global. max: $(0, e^4)$. Infl. pt: $(\pm \frac{1}{\sqrt{2}}, e^{3.5})$ (c) L.max: $(-2, -\frac{1}{2}e)$

9. (a) Global max at (e, e^{-1}) . Infl. pt at $(e^{1.5}, 1.5e^{-1.5})$ (b) Global min at $(\frac{1}{\sqrt{2}}, 2 + \frac{1}{2}\ln 2)$

(c) Global min at $(2, 1 + \ln 2)$; Infl. pt at $(4, 2 + \ln 4)$ (d) none 10. Global min at $(\frac{\pi}{6}, \sqrt{3})$

11. (a) $f'(x) = (x-2)^{a-1}(x+2)^{b-1}((a+b)x + 2(a-b))$

(b) i. $f(x) = \frac{x-2}{x+2}$; none ii. $f(x) = (x-2)^2(x+2)$ local max at $(-\frac{2}{3}, \frac{256}{27})$; local min at $(2, 0)$

iii. $f(x) = (x-2)^2(x+2)^2$; local min at $(\pm 2, 0)$, local max at $(0, 16)$.

12. (b) local min at $(c, 5^c + c^{-1})$ 13. (a) Global. min at $(1, c-1)$; $c \geq 1$ 14.

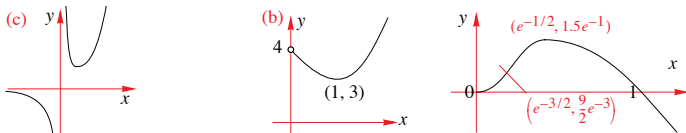

15. Global max at $(e^{0.5}, 0.5e^{-1})$; Infl. pt at $(e^{5/6}, \frac{5}{6}e^{-5/3})$.

EXERCISE 20.4

1. (a) $y = 2x, x = -1$ (b) $y = 1, x = -\frac{1}{3}$ (c) $y = \frac{1}{2}, x = -\frac{1}{4}$ (d) $y = -1, x = -3$ (e) $y = 3, x = 0$

(f) $y = 5, x = 2$

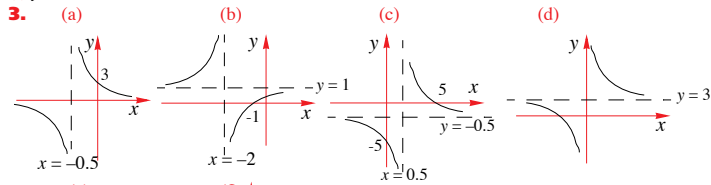

4. $a = 2, c = 4$

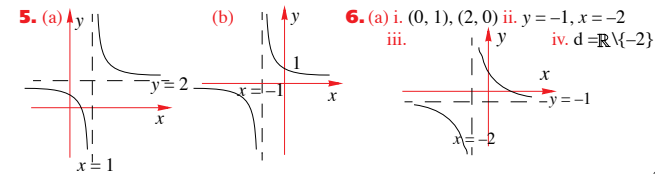
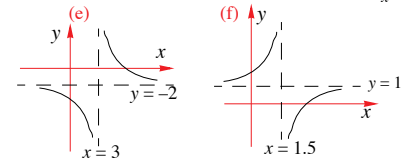

(b) $f^{-1}: \mathbb{R} \setminus \{-1\} \rightarrow \mathbb{R}$, where $f^{-1}(x) = \frac{2(1-x)}{(1+x)}$

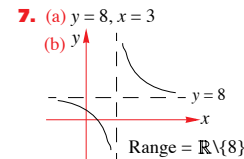
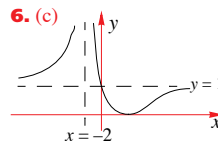

8. $\text{dom} = \mathbb{R} \setminus \{0\}, \text{ran} = \mathbb{R} \setminus \{2\}$ $\text{dom} = \mathbb{R} \setminus \{-0.5, 0\}, \text{ran} = \mathbb{R} \setminus \{0.5\}$

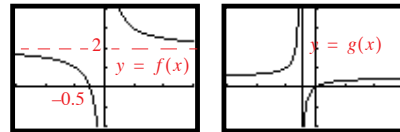

9. asymptotes (a) $y = 2x, x = 0$ (b) $y = \frac{1}{2}x, x = 0$ (c) $y = -x, x = 0$ (d) $y = x, x = 0$

10. asymptotes (a) $y = x^2, x = 0$ (b) $y = x^2, x = 0$ (c) $y = x, x = 0$ (d) $y = x^3, x = 0$

11. asymptotes (a) $y = x+3, x = 0$ (b) $y = -x+2, x = 0$ (c) $y = 2x-2, x = 0$

(d) $y = x+2, x = 0$ 12. (a) i. $(0, 4), (2, 0)$ ii. $y = 3-x, x = 1$

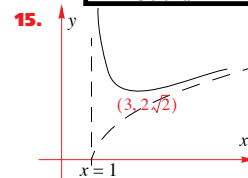
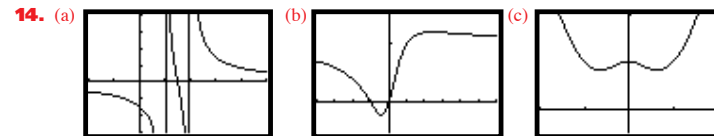
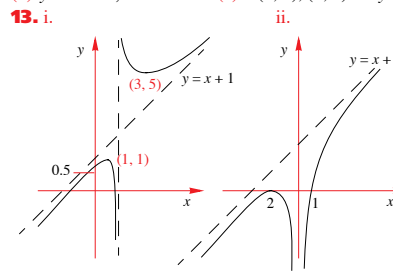

EXERCISE 21.1

1. (a) i. $x < 0$ ii. $x > 4$ iii. $0 \leq x \leq 4$ (b) i. $-1 < x < 2$ ii. $x < -1, 2 < x < 5$ iii. \emptyset
 (c) i. $-1 < x < 1$ ii. $x < -1$ iii. $x \geq 1$ (d) i. $0 < x < 1$ ii. $2 < x < 3$ iii. $x < 0, 1 \leq x < 2$
 (e) i. \emptyset ii. $-2 < x < 4$ iii. \emptyset (f) i. $-4 < x < -1, 2 < x < 5$ ii. $-1 < x < 2, 5 < x < 8$ iii. \emptyset

EXERCISE 21.2

1. 4.4 (4 deer per year, to nearest integer) 2. (a) 200 cm³ (b) 73.5 cm³day⁻¹ 3. (a) 75 (b) No
 4. (a) \$207.66 (b) \$ 40.79 per year (c) \$41.54 per year 5. i. 2.50 ii. 3.33 iii. 2.50
 6. (a) 1230 $< x < 48770$ (approx) (b) i. $0 < x < 25000$ ii. $25000 < x < 50000$ 7. 66667 (to nearest integer), 1446992 (to nearest integer) 8. (b) 133.33 (d) 46.67 (e) $0 < x < 5700$
 9. (a) $D'(x) = \frac{-40000(2x+12)}{(x^2+12x+20)^2}$ $5 \leq x \leq 18$ (b) 22.22 (22 items/dollar) 10. (a) $\frac{3000}{(x+32)^2}$
 (b) i. $x \geq 0$ ii. $x \in \emptyset$ 11. (a) i. 0 mm/s ii. ~ 90.69 mm/s (b) 0.6 sec 12. (a) 8.53 cm/s (b) (c) never
 13. $-e^{-1}$ ms⁻²

EXERCISE 21.3

1. (a) i. $v = -\frac{1}{(t-1)^2}, t > 1$ ii. $a = \frac{2}{(t-1)^3}, t > 1$ (b) i. $v = 2(e^{2t} - e^{-2t}), t \geq 0$
 ii. $a = 4(e^{2t} + e^{-2t}), t \geq 0$ (c) i. $v = \frac{2}{\sqrt{4-t^2}}, 0 \leq t < 2$ ii. $a = \frac{2t}{(4-t^2)^{3/2}}, 0 \leq t < 2$
 (d) i. $v = \frac{t}{(t+1)\ln 10} + \log_{10}(t+1), t \geq 0$ ii. $a = \frac{1}{\ln 10} \left[\frac{1}{(t+1)^2} + \frac{1}{t+1} \right], t \geq 0$
 (e) i. $v = a - 2bte^{-t^2}, t \geq 0$ ii. $a = 2be^{-t^2}(2t^2 - 1), t \geq 0$
 (f) i. $v = (\ln 2) \times 2^{t+1} - (\ln 3) \times 3^t, t \geq 0$ ii. $v = (\ln 2)^2 \times 2^{t+1} - (\ln 3)^2 \times 3^t, t \geq 0$
 2. (a) 8 ms⁻¹ (b) never at rest (c) i. 5m from O in negative direction ii. 4 ms⁻¹ (d) 40 m

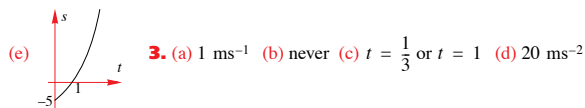

3. (a) 1 ms⁻¹ (b) never (c) $t = \frac{1}{3}$ or $t = 1$ (d) 20 ms⁻²
 4. (a) $v = -6t^2 + 12$; $a = -12t$ (b) ~ 1.41 sec (c) once (d) use graphics calculator
 5. (a) 3 m in positive direction (b) i. 5 m ii. 2 m (c) 5 ms⁻¹ (e) oscillation about origin with amplitude 5 m and period 2π sec 7. (a) 100 m, in negative direction (b) 3 times (c) i. 80 ms⁻¹
 ii. -34 ms⁻² (d) 14.81m 8. (a) max = 5 units, min = -1 unit (b) $\frac{\pi}{2}$ sec (c) i. $a = -12 \cos(2t - \pi)$
 ii. $a = -4(x-2)$ 9. (a) 0.318 m above (b) i. $v = 3.75e^{-0.25t} - 3$ ii. $a = -0.9375e^{-0.25t}$
 (c) 0.322 m (d) $a = -0.25(v+3)$ 10. (a) $0 < t < 0.5$ or $t > 1$ (b) $t > 0.5$ (c) $t = 1$ or $1.68 \leq t \leq 5$.

11. (a) This question is best done using a graphics calculator:
 (b) From the graph the particles pass each other three times.
 (c) 0.45 sec; 2.85 sec; 3.87 sec

- (d) i. $v_A = -0.3e^{0.3t}$ ms⁻¹ ii. $v_B = 10e^{-t}(1-t)$ ms⁻¹
 (e) Yes. On two occasions

12. (a) 2m in positive direction (b) i. 2 sec ii. never (c) 0.026 ms⁻²

13. (a) (b) 0.295 14. (a) (b) i. -39.99 ms⁻¹ ii. -36.20 ms⁻²

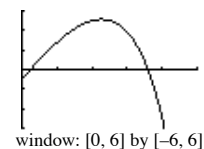
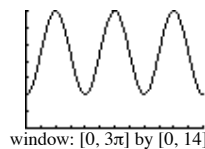
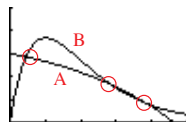

- (c) 2.27 sec (d) 5.14 m

EXERCISES 21.4

1. (a) $4\pi r$ cm²s⁻¹ (b) 4π cms⁻¹ 2. 6 cm²s⁻¹ 3. (a) $\frac{dA}{dt} = -\frac{3}{2}\sqrt{2}x$ cm²s⁻¹ (x = side length)
 (b) $-\frac{3}{2}\sqrt{2}$ cms⁻¹ 4. (a) 37.5 cm³hr⁻¹ (b) 30 cm²hr⁻¹ (c) 0.96 gm⁻¹cm³hr⁻¹ 5. ~ 0.37 cms⁻¹
 6. -0.24 cm³min⁻¹ 7. (a) 0.035 ms⁻¹ (b) 0.035 ms⁻¹ 8. 8π cm³min⁻¹ 9. 854 km hr⁻¹
 10. $\frac{53}{6}$ 11. 2 rad s⁻¹ 12. i. $V = h^2 + 8h$ ii. $\frac{4}{15}$ m min⁻¹ iii. 0.56 m²min⁻¹
 13. $\frac{3\sqrt{10}}{200}$ m min⁻¹ 14. $10\sqrt{2}$ cm³s⁻¹ 15. 0.9 ms⁻¹ 16. -3.92 ms⁻¹

17. (a) $x = 30 - 0.15t$ (b) [0, 200] (c) i. 1531 cm³s⁻¹ ii. 15.90 cm²s⁻¹ (d)

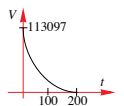

18. ~ 1.24 ms⁻¹ 19. ~ 0.0696 ms⁻¹ 20. (a) $y = \sqrt{119 + 20t - 4t^2}$ (b) ~ 0.516 ms⁻¹
 21. (a) 0.095 cms⁻¹ (b) 0.6747 cm²s⁻¹ 22. (a) i. $x = 70t$ ii. $y = 80t$ (b) 130t (c) 130 kmh⁻¹
 (d) 14.66 kmh⁻¹ 23. -0.77 ms⁻¹ 24. 0.40 ms⁻¹ 25. 3.2 ms⁻¹ 26. 0.075 m min⁻¹
 27. 1.26° per sec 28. $\frac{5}{2564} \approx 0.002$ rad per sec 29. (a) 9% per sec (b) 6% per sec
 30. 0.064 31. 8211 per year 32. 4% per sec 33. -0.25 rad per sec

EXERCISES 21.5

1. 22.6 m 2. (a) 1.5 kmh⁻¹ (b) \$19.55 per km 3. (a) 400 (b) \$46,400,000 4. \$273.86
 5. \$0.40 6. 1.97 m 7. 0.45 m³ 8. 5m by 5m 9. 128
 10. $r = \frac{50}{4+\pi} \approx 7.00$, dim of rect. $\frac{50}{4+\pi} \times \frac{50}{4+\pi}$ i.e., approx 7.00 m by 7.00 m 11. $\theta = \frac{\pi}{6}$

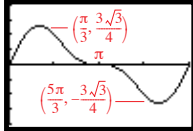
12. (a)  (b) $\frac{3\sqrt{3}}{2}$ units (c) At points of inflections, when $\cos x = -\frac{1}{4}$.

13. 648 m² 14. (a) 10.5 (b) 5.25 15. 72 16. (a) $y = 100 - 2x$ (b) $A = x(100 - 2x), 0 < x < 50$
 (c) $x = 25, y = 50$ 17. (a) $\frac{100}{x} - \frac{1}{2}x, 0 < x < 10\sqrt{2}$ (b) $\frac{2000}{9}\sqrt{6} \approx 544.3$ cm³

18. (a) 400 ml s⁻¹ (b) 40 sec (c)

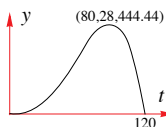

19. (a)

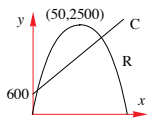

(b) 8.38, 71.62 (c) $9 \leq x \leq 71$ (d) $80x - x^2 - 600$, \$1000 20. $(\sqrt{\frac{11}{2}}, \frac{7}{2})$ & $(-\sqrt{\frac{11}{2}}, \frac{7}{2})$

21. $5\sqrt{2}$ by $\frac{5}{2}\sqrt{2}$ 22. 4 by $\frac{8}{3}$ 23. $348 - 8\sqrt{170} \sim 243.7$ cm² 24. 2 25. radius = $\sqrt{\frac{10}{3}}$ cm,

height = $2\sqrt{\frac{10}{3}}$ cm 26. $\sqrt[3]{\frac{15}{\pi}}$ 27. 5 cm 28. (a) $h = \frac{24r^2}{r^2 - 144}$ (b) $\frac{8\pi r^4}{r^2 - 144}$ (c) $r = 12\sqrt{2}$,

$h = 48$ 29. $r : h = 1 : 2$ 30. $\sim (0.55, 1.31)$ 31. (b) 2.5 m 32. altitude = $\frac{1}{3}$ height of cone

33. ~ 1.640 m wide and 1.040 m high 34. $\frac{2\sqrt{2}}{\sqrt{3}}\pi$ 35. where XP : PY = $b : a$ 36. 5 km

37. $r : h = 1 : 1$ 38. $\frac{4}{3}$ cm 39. 2 : 1 40. $\frac{10}{\sqrt{3}\pi}$ 41. 0.873 km from P

42. (b) $r = 3\sqrt{2}$, $h = 6\sqrt{2}$ 43. (b) when $\theta = \arcsin(\frac{5}{6})$, i.e., approx. 6.030 km from P.

44. (a) $\tan \theta = \frac{x'l}{x^2 + k(l+k)}$ (b) $x = \sqrt{k^2 + kl}$

45. (c) if $k < c$, swimmer should row directly to Q. 46. (a) i. $\pi r^2 h + \frac{2}{3}\pi r^3$ ii. $3\pi r^2 + 2\pi r h$

(c) $r : h = 1 : 1$ 47. $(a^{2/3} + b^{2/3})^{3/2}$ 48. (b) 4 km along the beach (c) row directly to destination

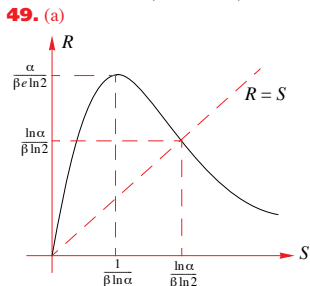

(b) First integer greater than $\frac{\ln \alpha}{\beta \ln 2}$

50. $\sqrt{295 \times 145} \approx 207$ m

51. (a) isosceles triangle

(b) isosceles right-angled triangle

52. $r^2(\frac{1}{2} + \frac{1}{4}\sqrt{3})$ sq. units 53. $\frac{4k^2 + 4k - 1}{8k(k+1)}$ sq. units

54. (a) $c = -r$

EXERCISE 22.1

1. (a) $\frac{1}{4}x^4 + c$ (b) $\frac{1}{8}x^8 + c$ (c) $\frac{1}{6}x^6 + c$ (d) $\frac{1}{9}x^9 + c$ (e) $\frac{4}{3}x^3 + c$ (f) $\frac{7}{6}x^6 + c$ (g) $x^9 + c$

(h) $\frac{1}{8}x^4 + c$ 2. (a) $5x + c$ (b) $3x + c$ (c) $10x + c$ (d) $\frac{2}{3}x + c$ (e) $-4x + c$ (f) $-6x + c$

(g) $-\frac{3}{2}x + c$ (h) $-x + c$ 3. (a) $x - \frac{1}{2}x^2 + c$ (b) $2x + \frac{1}{3}x^3 + c$ (c) $\frac{1}{4}x^4 - 9x + c$

(d) $\frac{2}{5}x + \frac{1}{9}x^3 + c$ (e) $\frac{1}{3}x^{3/2} + \frac{1}{x} + c$ (f) $x^{5/2} + 4x^2 + c$ (g) $\frac{1}{3}x^3 + x^2 + c$ (h) $x^3 - x^2 + c$

(i) $x - \frac{1}{3}x^3 + c$ 4. (a) $\frac{1}{3}x^3 - \frac{1}{2}x^2 - 6x + c$ (b) $\frac{1}{4}x^4 - \frac{2}{3}x^3 - \frac{3}{2}x^2 + c$ (c) $\frac{1}{4}(x-3)^4 + c$

(d) $\frac{2}{5}x^5 + \frac{1}{2}x^4 + \frac{1}{3}x^3 + \frac{1}{2}x^2 + c$ (e) $x + \frac{1}{2}x^2 - \frac{2}{3}x^{3/2} - \frac{2}{5}x^{5/2} + c$

(f) $\frac{2}{7}x^{7/2} + \frac{4}{5}x^{5/2} + \frac{2}{3}x^{3/2} - 2x + c$ 5. (a) $\frac{1}{2}x^2 - 3x + c$ (b) $2u^2 + 5u + \frac{1}{u} + c$

(c) $-\frac{1}{x} - \frac{2}{x^2} - \frac{4}{3x^3} + c$ (d) $\frac{1}{2}x^2 + 3x + c$ (e) $\frac{1}{2}x^2 - 4x + c$ (f) $\frac{1}{3}t^3 + 2t - \frac{1}{t} + c$

6. (a) $\frac{4}{7}\sqrt{x^7} + 2\sqrt{x} - 5x + c$ (b) $\frac{1}{3}x^3 + \frac{1}{2}x^2 - \frac{4}{7}x^{7/2} - \frac{4}{5}x^{5/2} + c$ (c) $-\frac{1}{2z^2} + \frac{2}{z} + 2z^2 + z + c$

(d) $\frac{1}{2}t^4 + t + c$ (e) $\frac{2}{5}\sqrt{t^5} - 2\sqrt{t^3} + c$ (f) $\frac{1}{3}u^3 + 2u^2 + 4u + c$ 8. (a) $\frac{1}{8}(2x+3)^4 + c$

(b) $3\sqrt{x^2+4} + c$

EXERCISE 22.2

1. (a) $x^2 + x + 3$ (b) $2x - \frac{1}{3}x^3 + 1$ (c) $\frac{8}{3}\sqrt{x^3} - \frac{1}{2}x^2 - \frac{40}{3}$ (d) $\frac{1}{2}x^2 + \frac{1}{x} + 2x - \frac{3}{2}$ (e) $(x+2)^3$

(f) $\frac{3}{4}\sqrt[3]{x^4} + \frac{1}{4}x^4 + x$ (g) $\frac{1}{3}x^3 + 1$ (h) $x^4 - x^3 + 2x + 3$ 2. $\frac{1}{2}x^2 + \frac{1}{x} + \frac{5}{2}$ 3. \$3835.03

4. 9.5 5. $\frac{251}{3}\pi$ cm³ 6. 292 7. $\frac{5}{7}\sqrt{x^3} + \frac{23}{7}$ 8. (1, -8) 9. $P(x) = 25 - 5x + \frac{1}{3}x^2$

10. $N = \frac{20000}{201}t^{2.01} + 500$, $t \geq 0$ 11. (a) $y = -\frac{2}{5}x^2 + 4x$ (b) $y = \frac{1}{6}x^3 + \frac{5}{4}x^2 + 2x$

12. $y = 2(x^3 + x^2 + x)$ 13. $f(x) = -\frac{3}{10}x^3 + \frac{49}{10}x - \frac{13}{5}$ 14. Vol ~ 43202 cm³ 15. 110 cm²

EXERCISE 22.3

1. (a) $\frac{1}{5}e^{5x} + c$ (b) $\frac{1}{3}e^{3x} + c$ (c) $\frac{1}{2}e^{2x} + c$ (d) $10e^{0.1x} + c$ (e) $-\frac{1}{4}e^{-4x} + c$ (f) $-e^{-4x} + c$

(g) $-0.2e^{-0.5x} + c$ (h) $-2e^{-x} + c$ (i) $5e^{x+1} + c$ (j) $e^{2-x} + c$ (k) $3e^{x/3} + c$ (l) $2\sqrt{e^x} + c$

2. (a) $4\log_e x + c$, $x > 0$ (b) $-3\log_e x + c$, $x > 0$ (c) $\frac{2}{5}\log_e x + c$, $x > 0$ (d) $\log_e(x+1) + c$, $x > -1$

(e) $\frac{1}{2}\log_e x + c$, $x > 0$ (f) $x - 2\log_e x - \frac{1}{x} + c$, $x > 0$ (g) $\frac{1}{2}x^2 - 2x + \log_e x + c$, $x > 0$

(h) $3\ln(x+2) + c$ 3. (a) $-\frac{1}{3}\cos(3x) + c$ (b) $\frac{1}{2}\sin(2x) + c$ (c) $\frac{1}{5}\tan(5x) + c$ (d) $\cos(x) + c$

4. (a) $-\frac{1}{2}\cos(2x) + \frac{1}{2}x^2 + c$ (b) $2x^3 - \frac{1}{4}\sin(4x) + c$ (c) $\frac{1}{5}e^{5x} + c$ (d) $-\frac{4}{3}e^{-3x} - 2\cos(\frac{1}{2}x) + c$

(e) $3\sin(\frac{x}{3}) + \frac{1}{3}\cos(3x) + c$ (f) $\frac{1}{2}e^{2x} + 4\log_e x - x + c$, $x > 0$ (g) $\frac{1}{2}e^{2x} + 2e^x + x + c$

(h) $\frac{5}{4}\cos(4x) + x - \log_e x + c$, $x > 0$ (i) $\frac{1}{3}\tan(3x) - 2\log_e x + 2e^{x/2} + c$, $x > 0$

- (j) $\frac{1}{2}e^{2x} - 2x - \frac{1}{2}e^{-2x} + c$ (k) $\frac{1}{2}e^{2x+3} + c$ (l) $-\frac{1}{2}\cos(2x + \pi) + c$ (m) $\sin(x - \pi) + c$
- (n) $-4\cos\left(\frac{1}{4}x + \frac{\pi}{2}\right) + c$ (o) $2\left(\frac{e^x + 2}{\sqrt{e^x}}\right) + c$ **5.** (a) $\frac{1}{16}(4x - 1)^4 + c$ (b) $\frac{1}{21}(3x + 5)^7 + c$
- (c) $-\frac{1}{5}(2 - x)^5 + c$ (d) $\frac{1}{12}(2x + 3)^6 + c$ (e) $-\frac{1}{27}(7 - 3x)^9 + c$ (f) $\frac{1}{5}\left(\frac{1}{2}x - 2\right)^{10} + c$
- (g) $-\frac{1}{25}(5x + 2)^{-5} + c$ (h) $\frac{1}{4}(9 - 4x)^{-1} + c$ (i) $-\frac{1}{2}(x + 3)^{-2} + c$ (j) $\ln(x + 1) + c, x > -1$
- (k) $\ln(2x + 1) + c, x > -\frac{1}{2}$ (l) $-2\ln(3 - 2x) + c, x < \frac{3}{2}$ (m) $3\ln(5 - x) + c, x < 5$
- (n) $-\frac{3}{2}\ln(3 - 6x) + c, x < \frac{1}{2}$ (o) $\frac{5}{3}\ln(3x + 2) + c, x > -\frac{2}{3}$ **6.** (a) $-\frac{1}{2}\cos(2x - 3) - x^2 + c$
- (b) $6\sin\left(2 + \frac{1}{2}x\right) + 5x + c$ (c) $\frac{3}{2}\sin\left(\frac{1}{3}x - 2\right) + \ln(2x + 1) + c$ (d) $10\tan(0.1x - 5) - 2x + c$
- (e) $2\ln(2x + 3) + 2e^{-\frac{1}{2}x+2} + c$ (f) $-\frac{2}{2x+3} - \frac{1}{2}e^{2x-\frac{1}{2}} + c$ (g) $x + \ln(x + 1) - 4\ln(x + 2) + c$
- (h) $2x - 3\ln(x + 2) + \frac{1}{2}\ln(2x + 1) + c$ (i) $-\frac{1}{2x+1} + \ln(2x + 1) + c$
- 7.** (a) $f(x) = \frac{1}{6}\sqrt{4x + 5}^3$ (b) $f(x) = 2\ln(4x - 3) + 2$ (c) $f(x) = \frac{1}{2}\sin(2x + 3) + 1$
- (d) $f(x) = 2x + \frac{1}{2}e^{-2x+1} + \frac{1}{2}e$ **8.** 14334 **9.** 13.19ms⁻¹ or 1.19ms⁻¹ **10.** 2.66cm
- 11.** $2e^{x/2} - \frac{1}{2}\sin(2x) - 2$ **12.** (a) $p = \frac{a}{a^2 + b^2}, q = -\frac{b}{a^2 + b^2}$ (b) $\frac{1}{13}e^{2x}(2\sin 3x - 3\cos 3x) + c$
- 13.** (a) 0.25a (b) $a \times \left(\frac{8}{12}\right)^{8/3} \approx 0.1575a$ **14.** (b) 666 gm
- 15.** (a) (b) 73.23% (c) ~25.24 litres **16.** (a) (b) 7000 (c) 1.16 day (d) 2 days

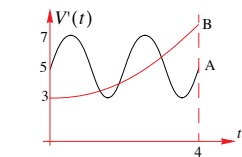
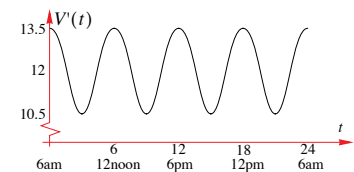

EXERCISES 22.4

- 1.** (a) $\frac{15}{2}$ (b) $\frac{38}{3}$ (c) $\frac{35}{36}$ (d) -8 **2.** (a) $\frac{35}{24}$ (b) $\frac{8}{5}\sqrt{2} - 2$ (c) -2 (d) 0 (e) $\frac{1}{20}$ (f) $-\frac{4}{3}$ (g) $\frac{7}{6}$
- (h) $\frac{5}{6}$ (i) $\frac{20}{3}$ (j) 0 (k) $\frac{20}{3}$ (l) $-\frac{\sqrt{2}}{3}$ **4.** (a) e (b) $2(e^{-2} - e^{-4})$ (c) 0 (d) $2(e - e^{-1})$
- (e) $e^2 + 4 - e^{-2}$ (f) $\frac{1}{2}(e - e^5)$ (g) $2\sqrt{e} - 3$ (h) $\frac{1}{4}(16e^{1/4} - e^4 - 15)$ (i) $\frac{1}{2}(e^{-1} - e^3)$
- 6.** (a) $3\ln 2$ (b) $2\ln 5$ (c) $4 + 4\ln 3$ (d) $\frac{1717}{4}$ (e) $\frac{3}{2}\ln 3$ (f) $2\ln 2$ (g) $\frac{3}{4}$ (h) $4\ln 2 - 2$ (i) $\ln 2$

- 8.** (a) 1 (b) $\frac{3\sqrt{3}}{2}$ (c) $\frac{\sqrt{3}}{2}$ (d) -2 (e) $\frac{\pi^2}{32} - 1$ (f) 0 (g) 0 (h) $\frac{\sqrt{3}}{2} - \frac{1}{2}$ (i) 0 (j) 2 **9.** (a) $\frac{31}{5}$
- (b) $\frac{7\sqrt{7}}{3} - \sqrt{3}$ (c) 0 (d) $\frac{5}{72}$ (e) $3\sqrt[3]{2} - \frac{3}{2}$ (f) $1 - \ln 2$ (g) $\frac{76}{15}$ (h) $\frac{16}{15}$ (i) $\frac{2}{3}(e + 1)^{3/2}(1 - e^{-3/2})$
- 10.** $\ln\left(\frac{21}{5}\right)$ **11.** $\sin 2x + 2x \cos 2x; 0$ **12.** (a) $2m - n$ (b) $m + a - b$ (c) $-3n$ (d) $m(2a - b)$
- (e) na^2 **13.** (a) $e^{0.1x} + 0.1xe^{0.1x}; 10xe^{0.1x} - 100e^{0.1x} + c$ (b) i. 99 accidents
ii. $N = 12t + 10te^{0.1t} - 100e^{0.1t} + 978$ **14.** (a) 1612 subscribers (b) 46220 **15.** (b) ~524 flies

EXERCISES 22.5

- 1.** (a) 4 sq.units. (b) $\frac{32}{3}$ sq.units. (c) 4 sq.units. (d) 36 sq.units. (e) $\frac{1}{6}$ sq.units. **2.** (a) e sq.units.
- (b) $\frac{1}{2}(e^4 - 2 - e^2)$ sq.units. (c) $2(e + e^{-1} - 2)$ sq.units. (d) $2(e^2 - 2 - e)$ sq.units.
- 3.** (a) $\ln\left(\frac{5}{4}\right)$ sq.units. (b) $2\ln 5$ sq.units. (c) $3\ln 3$ sq.units. (d) 0.5 sq.units. **4.** (a) 2 sq.units.
- (b) $\frac{\pi}{2}$ sq.units. (c) $\frac{3}{8}\pi^2 + \sqrt{2} - 2$ sq.units. (d) $\sqrt{2}$ sq.units. (e) $4\sqrt{3}$ sq.units. **6.** 12 sq.units.
- 7.** $4\left(\sqrt{3} - \frac{1}{3}\right)$ sq.units. **8.** $\ln 2 + 1.5$ sq.units. **9.** 2 sq.units. **10.** $\frac{37}{12}$ sq.units. **11.** (a) 0.5 sq.units.
- (b) 1 sq.unit. (c) $2(\sqrt{6} - \sqrt{2})$ sq.units. **12.** $\frac{8}{3}$ **13.** $-2\ln 2$; $\frac{1}{4}\ln 2$ sq.units.
- 14.** (a) $\frac{9}{2}$ sq.units. (b) 3 sq.units. **15.** (a) 1 sq.unit. (b) 10 sq.units. **16.** (a) $x \ln x - x + c$
- (b) 1 sq.unit. **17.** $\frac{14}{3}$ sq.units **18.** (a) $\frac{7}{6}$ sq.units (b) $\frac{9}{2}$ sq.units **19.** i. $\frac{15}{4}$ sq.units ii. $\frac{45}{4}$ sq.units
- 20.** $\frac{22}{3}$ sq.units. **21.** (b) i. $e^{-1} + e - 2$ sq. units ii. 1 sq. unit iii. $2\ln(2)$ sq. units
- 22.** (b) 3.05 sq. units **23.** (a) $2y = 3ax - a^3$ (b) $\frac{1}{15}a^5$ sq. units **24.** (a) $1 - e^{-1}$ sq. units
- (b) e^{-1} sq. units (c) $1 - e^{-e^{-1} - 1} - e^{-1} \sim 0.10066$ sq. units **25.** $a = 16$

EXERCISES 22.6

- 1.** (a) $x = t^3 + 3t + 10, t \geq 0$ (b) $x = 4\sin t + 3\cos t - 1, t \geq 0$
- (c) $x = t^2 - 4e^{-\frac{1}{2}t} + 2t + 4, t \geq 0$ **2.** (a) $x = t^3 - t^2, t \geq 0$ (b) 100 (c) $100\frac{8}{27}$ m
- 3.** (a) $x = -\frac{2}{3}(4 + t)^{3/2} + 2t + 8$ (b) 6.92 m **4.** $\frac{125}{6}$ m **5.** $\frac{125}{49}$ sec; 63.8 m **6.** (a) $\frac{\pi}{6}$ sec
- (b) $\frac{\pi}{2} - 1$ m **7.** 80.37 m **8.** (a) $s(t) = \frac{160}{\pi}\left[1 - \cos\left(\frac{\pi}{16}t\right)\right], t \geq 0$ (b) 86.94 m (c) -6.33 m
- (d) 116.78 m **9.** (a) $v = 4 + k - \frac{k}{t^2}, t > 0$ (b) $k = 2$ (c) 52.2 m **10.** (b) 0.0893 m

EXERCISES 22.7.1

1. $k = \frac{1}{9}$, $\frac{1}{27}$ 2. 0.1 3. $k = 8$, $\frac{5}{16}$ 4. 0.05637 5. ii. 0.0067 6. i. $\frac{1}{\ln 3}$ ii. 0.369 7. ii. 0.135 iii. 1.8% iv. 3 8. i. 0.75 ii. 0.269 iii. 0.1495 iv. 0.575 10. $\sqrt{2}$

EXERCISES 22.7.2

1. i. Both 0.5 ii. Variance = $\frac{1}{12}$ SD ≈ 0.2887 2. i. Mode = 1, Mean = 0.75, Median ≈ 0.7937
ii. Var = 0.0375 Sd ≈ 0.1936 3. i. All 5gms ii. Var = 0.2, Sd ≈ 0.447 iii. [4.1065, 5.894]
4. i. Mode = 2, Mean = $\frac{4}{3}$, Median ≈ 1.414 ii. Std dev. ≈ 0.4714 iii. Mean. 5. i. 0 ii. ≈ 3.5 sec
iii. 5 sec iv. 5 sec v. 15 sec 6. All π 7. Mean = 8.5cm Variance = 1.25 8. (a) $80 \ln\left(\frac{4}{3}\right) \approx 23.01$
(b) $F(t) = 1 - e^{-t/80}$, $t \geq 0$ (c) Use graphics calculator 9. (b) $a = \frac{3}{7}$, $b = \frac{5}{2}$ (c) mode = 1.25
10. (a) $k = \frac{1}{2(\sqrt{5}-1)}$ (b) $\frac{\sqrt{5}-\sqrt{3}}{\sqrt{5}-1} \approx 0.4078$ (c) 4.62 days (d) 4.75 days
11. (a) $(1-x)^{3/2} - \frac{3}{2}x\sqrt{1-x}$ (b) i. 1.5 ii. $1 - \left(\frac{1}{2}\right)^{2/3} \approx 0.37$; 0 iii. 0.4

EXERCISES 22.8

All values are in cubic units

1. 21π 2. $\pi \ln 5$ 3. $\frac{4}{5}\pi$ 4. $\frac{\pi}{2}(e^{10} - e^2)$ 5. π^2 6. $\frac{\pi}{2}$ 7. $\frac{109}{3}\pi$ 8. $\pi\left(\frac{8}{3} - 2 \ln 3\right)$ 12. $\frac{\pi}{2}(5 - 5 \sin 1)$
13. $\frac{251}{30}\pi$ 14. (a) 40π (b) $\frac{242}{5}\pi$ 15. (a) $\frac{8}{35}\pi$ (b) $\frac{\pi}{4}$ 16. (a) $\frac{9}{2}\pi$ (b) $\frac{88}{5}\sqrt{3}\pi$ 17. $\frac{3\pi}{4}$ 18. $k = 1$
19. $4\pi^2 a^2$ 20. $k = \frac{\pi}{2}$ 21. (b) i. $\frac{\pi a}{2(1+a^2)}$ ii. $\frac{8\pi}{15}\sqrt{\frac{a}{1+a^2}}\left(\frac{3a^2+2}{1+a^2}\right)$ 22. (a) two possible solutions: solving $a^3 - 6a^2 - 36a + 204 = 0$, $a = 4.95331$; solving $a^3 - 6a^2 - 36a - 28 = 0$, then $a = -0.95331$. (b) $a = \frac{100}{\pi}$ 23. $\frac{28}{15}\pi$ 24. (a) $\frac{1472}{15}\pi$ (b) 64π (c) $\frac{576}{5}\pi$

EXERCISE 23.1.1

1. (a) $\frac{2}{3}(5x^2 + 2)^{3/2} + c$ (b) $-\frac{1}{3(x^3 + 4)} + c$ (c) $\frac{3}{8}(1 - 2x^2)^4 + c$ (d) $\frac{1}{5}(9 + 2x^{3/2})^5 + c$
(e) $\frac{9}{4}(x^2 + 4)^{4/3} + c$ (f) $\frac{-1}{2(x^2 + 3x + 1)^2} + c$ (g) $4\sqrt{x^2 + 2} + c$ (h) $\frac{1}{12(1 - x^4)^3} + c$
(i) $\frac{2}{3}(1 + e^{3x})^{3/2} + c$ (j) $\frac{-1}{2(x^2 + 2x - 1)} + c$ (k) $\frac{2}{3}\sqrt{x^3 + 3x + 1} + c$ (l) $\frac{1}{12}(3 + 4x^2)^{3/2} + c$
(m) $2\sqrt{e^x + 2} + c$ (n) $-\frac{1}{4}(1 - e^{-2x})^{-2} + c$ (o) $\frac{2}{3}(x^3 + 1)^5 + c$ (p) $\frac{1}{24}(x^4 + 8x - 3)^6 + c$
(q) $\frac{1}{5}(x^4 + 5)^{5/2} + c$ (r) $-\sqrt{1 - \sin 2x} + c$ (s) $\frac{2}{9}(4 + 3 \sin x)^{3/2} + c$ (t) $-\frac{1}{12(1 + 3 \tan 4x)} + c$

- (u) $\frac{3}{2}(x + \cos x)^{2/3} + c$ (v) $-\frac{1}{2}\cos^4 \frac{x}{2} + c$ (w) $2\sqrt{1 + x \sin x} + c$ (x) $\frac{4}{3}(x^{1/2} + 1)^{3/2} + c$
2. (a) $e^{x^2 + 1} + c$ (b) $6e^{\sqrt{x}} + c$ (c) $\frac{1}{3}e^{\tan 3x} + c$ (d) $-e^{-(ax^2 + bx)} + c$ (e) $-6e^{\frac{\cos x}{2}} + c$
(f) $-4e^{(4+x^{-1})} + c$ (g) $-\frac{1}{2}\cos(2e^x) + c$ (h) $\frac{1}{2(1 - e^{2x})} + c$ (i) $-\ln(1 + e^{-x}) + c$
(j) $\frac{5}{2}\ln(1 + 2e^x) + c$ (k) $-\frac{2}{3a}(4 + e^{-ax})^{3/2} + c$ (l) $\frac{(\ln(1 + e^{2x}))^2}{4} + c$
3. (a) $-\cos(x^2 + 1) + c$ (b) $-10\cos \sqrt{x} + c$ (c) $-2\sin\left(2 + \frac{1}{x}\right) + c$ (d) $-\frac{2}{3}(\cos x)^{3/2} + c$
(e) $-\frac{1}{3}\log(\cos 3x) + c$ (f) $\frac{4}{3}\log(1 + \tan 3x) + c$ (g) $\frac{-4}{3(\tan(3x) + 1)} + c$ (h) $2\sin(\ln x) + c$
(i) $-\frac{1}{6}(1 + \cos 2x)^{3/2} + c$ (j) $\sin(e^x) + c$ (k) $-e^{(-x^3 + 2)} + c$ (l) $\left[\ln\left(\sin \frac{1}{2}x\right)\right]^2 + c$
(m) $\sec x + c$ (n) $\frac{1}{4}[\ln(1 + 2e^x)]^2 + c$ (o) $\tan\left(\frac{1}{3}x^3 - 3x\right) + c$
4. (a) $\tan^{-1}\left(\frac{x}{2}\right) + c$ (b) $\tan^{-1}\left(\frac{x}{3}\right) + c$ (c) $\tan^{-1}\left(\frac{x}{\sqrt{5}}\right) + c$ (d) $\sin^{-1}\left(\frac{x}{5}\right) + c$ (e) $\sin^{-1}\left(\frac{x}{4}\right) + c$
(f) $\cos^{-1}\left(\frac{x}{3}\right) + c$ 5. (a) $3\tan^{-1}x + c$ (b) $5\sin^{-1}x + c$ (c) $\sin^{-1}\left(\frac{x}{2}\right) + c$ (d) $\sin^{-1}\left(\frac{x}{3}\right) + c$
(e) $\frac{1}{2}\sin^{-1}2x + c$ (f) $\frac{1}{2}\sin^{-1}\left(\frac{2x}{3}\right) + c$ (g) $\frac{1}{5}\sin^{-1}\left(\frac{5x}{2}\right) + c$ (h) $\tan^{-1}2x$ (i) $\frac{1}{6}\tan^{-1}\left(\frac{2x}{3}\right) + c$
(j) $\frac{1}{12}\tan^{-1}\left(\frac{4x}{3}\right) + c$ (k) $\frac{\sqrt{5}}{15}\tan^{-1}\left(\frac{\sqrt{5}x}{3}\right) + c$ (l) $\frac{1}{\sqrt{5}}\sin^{-1}\left(\sqrt{\frac{5}{3}}x\right) + c$ 6. (a) $\frac{531377}{9}$
(b) $-2\sqrt{2} + 2\sqrt{1+e}$ (c) $3\ln 2(2 + \sqrt{2})$ (d) $4\tan^{-1}\left(\frac{\pi}{2}\right)$ (e) $\sin e - \sin(e^{-1})$
(f) $\frac{2}{3}\left[1 - \cos\left(\frac{\pi}{2}\right)^{3/2}\right]$ (g) $\frac{2}{3}$ (h) $e - e^{-1}$ (i) $\ln 2$ (j) $\frac{7\sqrt{7}}{3}$ (k) 0 (l) $\frac{3}{5}$ (m) $\frac{\pi}{4}$ (n) $\frac{\pi}{2} - \tan^{-1}(2)$
(o) $\frac{1}{3}\tan^{-1}9$ (p) $\frac{1}{2}\sin^{-1}\left(\frac{2}{3}\right)$ (q) $\frac{1}{4}\left(\pi - 2\sin^{-1}\left(\frac{2}{3}\right)\right)$ (r) $\frac{1}{3}\tan^{-1}\left(\frac{3}{2}\right)$
(s) $\frac{1}{6}\left(\tan^{-1}\left(\frac{3}{4}\right) - \tan^{-1}\left(\frac{3}{16}\right)\right)$ (t) $\frac{1}{64}$ (u) $\frac{2}{3} - \frac{\sqrt{2}}{3}$ (v) $\frac{1}{3}$ (w) $\frac{3\pi}{4}$ (x) $-\frac{1}{60}$

EXERCISE 23.1.2

1. (a) $\frac{2}{3}(x^2 + 1)^{3/2} + c$ (b) $\frac{2}{3}(x^3 + 1)^{3/2} + c$ (c) $-\frac{1}{3}(4 - x^4)^{1.5} + c$ (d) $\ln(x^3 + 1) + c$
(e) $-\frac{1}{18(3x^2 + 9)^3} + c$ (f) $e^{(x^2 + 4)} + c$ (g) $\ln(\tau^2 + 4\tau - 5) + c$ (h) $-\frac{3}{8}(2 - t^2)^{4/3} + c$
(i) $e^{\sin x} + c$ (j) $\ln[e^x + 1] + c$ (k) $\frac{1}{5}\sin^5 x + c$ (l) $\frac{2}{5}(x + 1)^{5/2} - \frac{2}{3}(x + 1)^{3/2} + c$
2. (a) $\frac{1}{10}(2x - 1)^{5/2} + \frac{1}{6}(2x - 1)^{3/2} + c$ (b) $-\frac{2}{3}(1 - x)^{3/2} + \frac{4}{5}(1 - x)^{5/2} - \frac{2}{7}(1 - x)^{7/2} + c$

- (c) $\frac{2}{5}(x-1)^{5/2} + \frac{4}{3}(x-1)^{3/2} + c$ (d) $e^{\tan x} + c$ (e) $-\ln(1-2x^2) + c$ (f) $\frac{1}{1-2x^2} + c$
- (g) $\frac{1}{2}(\ln x)^2 + c$ (h) $-\ln(1+e^{-x}) + c$ (i) $\ln(\ln x) + c$ **3.** (a) 0 (b) $\frac{2\ln 2}{3}$ (c) $\ln \frac{77}{54}$ (d) $\ln 2$
- (e) $\frac{1}{3}\ln 2$ (f) $\frac{1}{4}$ (g) $\frac{76}{15}$ (h) $\frac{16}{15}$ (i) $\frac{2}{3}(1+e)^{3/2}(1-e^{-3/2})$ **4.** (a) $\frac{7\sqrt{7}}{3} - \frac{8}{3}$ (b) $\frac{3}{8}(\cos \pi^2 - 1)$
- (c) $\frac{1042}{5}$ (d) $\ln 4$ (e) 1 (f) $\frac{5}{4}(e^5 - e^{-1})$ (g) 24414 (h) $\sqrt{3} - \sqrt{2}$ (i) $\frac{1}{4}\ln 3$ **5.** (a) $\frac{1}{4}$ (b) $2 - \frac{2}{3}\sqrt{3}$
- (c) $\frac{31}{80}$ (d) $4 - 2\sqrt{2}$ (e) $\ln 2$ (f) $\frac{2}{3}$ **6.** (a) $-\frac{2}{5}\sqrt{3}$ (b) $\frac{2}{5}\sqrt{3}$ (c) $\frac{26}{3}$ (d) $-\frac{4}{3}$ (e) $-\frac{56}{13}\sqrt{2}$ (f) $3 + 2\ln 4$
- 7.** (a) $\tan^{-1}(x+3) + c$ (b) $\frac{2}{\sqrt{3}}\tan^{-1}\left(\frac{2x-1}{\sqrt{3}}\right) + c$ (c) $\sin^{-1}\left(\frac{x-2}{\sqrt{5}}\right) + c$ (d) $3\sin^{-1}\left(\frac{x+1}{3}\right) + c$
- (e) $2\sin^{-1}\left(\frac{2x-3}{\sqrt{29}}\right) + c$ (f) $\frac{1}{2}\sin^{-1}\left(\frac{x^2}{3}\right) + c$ (g) $\frac{1}{2}(\arcsin x)^2 + c$ (h) $-\frac{1}{3}(\arccos x)^3 + c$
- (i) $-\frac{1}{2}(\arcsin x)^{-2} + c$ **8.** (a) $A = 1, B = -2$ **9.** (a) $\tan^{-1} k$ (b) i. $\frac{\pi}{6}$ ii. $\frac{\pi}{4}$ (c) $\frac{\pi}{2}, \pi$
- 10.** $2\sqrt{x} - 2\ln(\sqrt{x}+1), 2 - 2\ln 2$ **11.** $\frac{3k^2\pi}{8}$ **12.** $\frac{\pi a^2}{4}$

EXERCISE 23.2.1

- 1.** (a) $\sin x - x\cos x + c$ (b) $4\cos \frac{x}{2} + 2x\sin \frac{x}{2} + c$ (c) $2\left(4\sin \frac{x}{2} - 2x\cos \frac{x}{2}\right) + c$
- (d) $-e^{-x}(x+1) + c$ (e) $-5e^{-4x}\left(\frac{x}{4} + \frac{1}{16}\right) + c$ (f) $x\ln x - x + c$ (g) $\frac{x^2}{2}\ln x - \frac{x^2}{4} + c$
- (h) $-\frac{1}{25}(\cos 5x + 5x\sin 5x) + c$ (i) $12\left(x\cos \frac{x}{3} - 3\sin \frac{x}{3}\right) + c$ (j) $\ln \cos x + x\tan x + c$
- (k) $\frac{2}{3}x\sqrt{x}\ln x - \frac{4}{9}x\sqrt{x} + c$ **2.** (a) $\frac{2}{15}(3x-2)(x+1)^{3/2} + c$ (b) $\frac{2}{15}(3x+4)(x-2)^{3/2} + c$
- (c) $\frac{2}{15}(3x+1)(x+2)^{3/2} + c$ **3.** (a) $x\cos^{-1}x - \sqrt{1-x^2} + c$ (b) $x\tan^{-1}x - \frac{1}{2}\ln(x^2+1) + c$
- (c) $x\sin^{-1}x + \sqrt{1-x^2} + c$
- 4.** (a) $\left(\frac{1}{2}x^2 - \frac{1}{4}\right)\cos^{-1}x - \frac{1}{4}x\sqrt{1-x^2} + c$ (b) $\frac{1}{2}(x^2+1)\tan^{-1}x - \frac{x}{2} + c$
- (c) $\frac{1}{4}(2x^2-1)\sin^{-1}x + \frac{1}{4}x\sqrt{1-x^2} + c$ **5.** (a) $\frac{1}{4}$ (b) $\frac{1}{4}(e^2+1)$ (c) $\frac{1}{4}(e^2-4)$ (d) $\frac{1}{4}$
- (e) $\frac{4\pi - \sqrt{2}\pi - 4\sqrt{2}}{32}$ (f) $\frac{1}{2}$ **6.** $\frac{1}{6}\ln 2 + \frac{\pi}{12} - \frac{1}{6}$ **7.** $\frac{1}{2}[\sqrt{2} + \ln(\sqrt{2}+1)]$
- 8.** (a) $\frac{x}{2}\cos(\ln x) + \frac{x}{2}\sin(\ln x) + c$ (b) $-\frac{x}{2}\cos(\ln x) + \frac{x}{2}\sin(\ln x) + c$
- (c) $-\frac{1}{15}(1-x^2)(2+3x^2)\sqrt{1-x^2} + c$

EXERCISE 23.2.2

- 1.** (a) $e^x(x^2-2x+2) + c$ (b) $3\left(\frac{x}{2}\cos 2x + \frac{2x^2-1}{4}\sin 2x\right) + c$ (c) $\frac{x^4}{4}\log 2x - \frac{x^4}{16} + c$
- (d) $-\frac{e^x}{5}(2\cos 2x - \sin 2x) + c$ (e) $\frac{2x}{9}\cos 3x + \frac{9x^2-2}{27}\sin 3x + c$ (f) $-\frac{e^{-2x}}{4}(\cos 2x - \sin 2x) + c$
- (g) $-8\left(x^3\cos \frac{x}{2} - 6x^2\sin \frac{x}{2} - 24x\cos \frac{x}{2} + 48\sin \frac{x}{2}\right) + c$ (h) $\frac{1}{2}(\ln x)^2 + c$
- (i) $2x - 2x\ln(3x) + x(\ln(3x))^2 + c$ (j) $-\frac{\cos x}{2} - \frac{\cos 3x}{6} + c$
- (k) $\frac{1}{1+a^4}\left(a^3e^{ax}\cos\left(\frac{x}{a}\right) + ae^{ax}\sin\left(\frac{x}{a}\right)\right) + c$ (l) $\left(\frac{2x^3}{7} + \frac{4x^2}{35} - \frac{32x}{105} + \frac{128}{105}\right)\sqrt{x+2} + c$
- (m) $\frac{x^4}{4}\ln ax - \frac{x^4}{16} + c$ (n) $2\sin^{-1}\left(\frac{x}{2}\right) - \frac{x}{2}\sqrt{4-x^2} + c$ (o) $\frac{3}{2}(x\sqrt{x^2-9} + 9\ln(x+\sqrt{x^2-9})) + c$
- (p) $\frac{1}{2}\ln(x^2+4) + c$ (q) $x - 2\tan^{-1}\left(\frac{x}{2}\right) + c$ **2.** (a) $\frac{\pi^2}{16} - \frac{1}{4}$ (b) $\frac{\pi}{8}$ (c) $\frac{1}{2}(e^{2\pi} - e^{\pi/2})$
- (d) $1 - \ln 2 - \frac{1}{2}(\ln 2)^2$ (e) $\frac{a}{a^2+b^2}\left(e^{\frac{2a\pi}{b}} + e^{\frac{a\pi}{b}}\right)$ (f) $e - 2$

EXERCISE 23.3

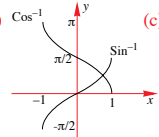
- 1.** $\frac{\ln 9}{3}$ **2.** (a) 4.66 m (b) 5 m (c) 12.28 m **3.** $\frac{\pi}{3}$
- 4.** (a)  (c) i. $\sqrt{2} - 1$ sq. units ii. $2 - \sqrt{2}$ sq. units (d) $\pi\left(\frac{\pi}{4} - \frac{1}{2}\right)$ cubic units
- 5.** (a) $\frac{4}{5}(1 - e^{-4\pi} + e^{-3\pi} + e^{-\pi})$ (b) $\frac{9\pi}{20}(1 - e^{-8\pi})$ cubic units **6.** (a) $\frac{3}{6\sqrt{3}-2\pi}$ (b) 0.5956

EXERCISE 24.1

- 5.** $m = -3, n = -4$ **7.** (a) $k = 2$ or 3 (b) $k = -3$ **8.** $a = 2, b = 2$ **9.** $a = -2, b = 2$
- 10.** $ay \frac{dy}{dx} = -x$

EXERCISE 24.2

- 1.** (a) $y = x - \frac{1}{2}\cos 2x + c$ (b) $y = \frac{1}{2}x - \frac{1}{4}\sin 2x + c$ (c) $y = 3\log_e(x^2+x) + c$
- 2.** (a) $y = \frac{1}{5}(2t^{5/2} + 3)$ (b) $x = 1 - 2\log_e(\cos 2t)$ (c) $y = \log_e \frac{1}{3}(x-1)(x+1) + 4$
- (d) $y = \frac{1}{3} - \frac{1}{(1-x)}$ (e) $x = u + \frac{k}{2t_0^2} - \frac{k}{2(t+t_0)^2}$ (f) $y = \frac{1}{2}\sin(x^2)$ (g) $x = \sin^4 t + 1$

(h) $N = \frac{1}{3}\sqrt{(25+t^2)^3} - \frac{110}{3}$ (i) $T = 9 - \frac{1}{3}\sqrt{(8 + \cos 2\theta)^3}$ (j) $P = \frac{10}{9} - \frac{1}{9}e^{-3t} - \frac{1}{3}te^{-3t}$

3. (a) $y = 3\sin(x+c)$ (b) $y = 1 - ke^{\frac{1}{2}x}$ (c) $y = 2(1 + ke^{2x})^{-1}$

4. (a) $t = 2 - \frac{1}{2N^2}$ (b) $s = 2\tan(2t)$ (c) $p = \frac{1}{2}\log_e(2x)$ (d) $y = \frac{3\tan(3x) + 3\pi}{1 - \pi\tan 3x}$

(e) $y = 4\arcsin(x) + 2$ (f) $y = \frac{98x}{14x+1}$ (g) $\theta = \frac{1}{2}\left(y + \frac{1}{2}\sin 2y - \pi\right)$

(h) $y - 2\arctan\left(\frac{y}{2}\right) = x + 2\pi$ 5. (a) $y = k(x+1)$ (b) $y = ke^{0.5x^2} - 1$

(c) $(y+1)^2 = x^2 + k$ (d) $y = \log_e(c - \cos x)$ (e) $y = \log_e(\sin x - x\cos x + c)$

(f) $e^y(y-1) = \sin x - x\cos x + c$ (g) $y = \sin\left(\frac{1}{2}x^2 + c\right)$

(h) $\frac{1}{2}y\sqrt{1-y^2} + \frac{1}{2}\arcsin y = \log_e x + c$ (i) $y\sqrt{1-y^2} + \arcsin y = x^2 + c$

6. (a) $y^2 = \arctan\left(\frac{x}{2}\right) + 1$ (b) $2e^{-y} = e^{-x^2} + 1$ (c) $e^{x-y} = x + 1$ (d) $x = 2e^{-0.5(1-t)^2}$

7. (a) $\arctan\left(\frac{y}{2}\right) = \log_e(1+x^2)$ (b) $2\arctan(x) = t^2 - 2$ 8. $x = \frac{1}{2}\left[\frac{3}{(3-y)^2} - 1\right]$

9. $y = 1 - e^{-x}$ 10. $y = \frac{1}{x}e^{(1-x^{-1})}$ 11. $y + 1 = \frac{1}{2}\sqrt{x + \frac{1}{2}\sin 2x} + 1$ 16. (a) $\frac{1}{4}\ln\left(\frac{x-2}{x+2}\right) + c$

(b) $y = \frac{2(5 + e^{4x})}{5 - e^{4x}}$ (c) $y = 2\tan\left(2x - \frac{\pi}{4}\right)$ 17. (a) $\frac{a}{y(a-y)}$ (b) $y = \frac{ae^{akx}}{(a-1) + e^{akx}}$

18. $y = \frac{1-x}{1+x}$ 19. $m = -k, n = -2k$

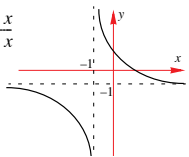

20. (c) $\frac{1}{p-q}\ln\left(\frac{p}{q}\right)$

EXERCISE 24.3

1. 65.61% 2. 31.5% 3. $\frac{dN}{dt} = kN$, 12.68 days. 4. 40.95% 5. 61.05%

7. $y = \frac{1}{2}\log_e(1+x^2)$ 8. 2928 9. $v = 39.2(1 - e^{-t/4})$; 39.2 m/sec 10. 2.5 mins

11. $t \approx 3.31$ 12. 42.5°C 13. (a) i. $x = 80e^{-0.1t}$, $t \geq 0$ ii. $x = 100 - 20e^{-0.1t}$, $t \geq 0$

(b) i. $x = 80\left(\frac{50}{50+t}\right)^4$, $t \geq 0$ ii. $x = 2(50+t) - 20\left(\frac{50}{50+t}\right)^4$, $t \geq 0$ 15. (b) $\frac{D}{I} \rightarrow \frac{k_1}{k_2}$

17. $I = I_0 e^{\frac{\alpha}{\beta}(e^{-\beta x} - 1)}$, $\alpha, \beta > 0$ 18. $Q = 2Ct - 2RC^2(1 - e^{-t/(RC)})$ 20. $\frac{\sqrt[3]{2}}{\sqrt[3]{2}-1}$ m minutes.

EXERCISE 25.1.1

1. (i) $\begin{bmatrix} 2 & 8 \\ -2 & 16 \end{bmatrix}$ (ii) $\begin{bmatrix} -2 & 3 \\ 1 & -5 \end{bmatrix}$ (iii) $\begin{bmatrix} 6 & -9 \\ -3 & 15 \end{bmatrix}$ (iv) $\begin{bmatrix} 4 & 5 \\ -3 & 21 \end{bmatrix}$ (v) $\begin{bmatrix} 7 & 6 \\ -5 & 34 \end{bmatrix}$ (vi) $\begin{bmatrix} -2 & -19 \\ 3 & -27 \end{bmatrix}$

2. (i) $\begin{bmatrix} -1 & -1 & -2 \\ 0 & 6 & -9 \end{bmatrix}$ (ii) $\begin{bmatrix} -2 & -2 & -4 \\ 0 & 12 & -18 \end{bmatrix}$ (iii) $\begin{bmatrix} -2 & -5 \\ 2 & 2 \\ 3 & 1 \end{bmatrix}$ (iv) $\begin{bmatrix} 2 & 0 \\ 4 & 2 \\ 0 & -2 \end{bmatrix}$ (v) $\begin{bmatrix} 5 & 5 \\ 4 & 1 \\ -3 & -4 \end{bmatrix}$ (vi) $\begin{bmatrix} -6 & -15 \\ 6 & 6 \\ 9 & 3 \end{bmatrix}$

3. (i) $\begin{bmatrix} 3 & 3 & 6 \\ 0 & 3 & 12 \\ 0 & 6 & 3 \end{bmatrix}$ (ii) $\begin{bmatrix} -2 & -4 & 6 \\ 4 & 0 & 2 \\ 4 & 0 & -8 \end{bmatrix}$ (iii) $\begin{bmatrix} 0 & -1 & 5 \\ 2 & 1 & 5 \\ 2 & 2 & -3 \end{bmatrix}$ (iv) $\begin{bmatrix} 2 & 3 & -1 \\ -2 & 1 & 3 \\ -2 & 2 & 5 \end{bmatrix}$ (v) $\begin{bmatrix} 1 & -1 & 12 \\ 4 & 3 & 14 \\ 4 & 6 & -5 \end{bmatrix}$ (vi) $\begin{bmatrix} -3 & -5 & 4 \\ 4 & -1 & -2 \\ 4 & -2 & -9 \end{bmatrix}$

4. (i) 23 (ii) Nuts (iii) Taps (iv) Week 2 Wednesday = B3 + I3, = B4 + I4 5. 7 by 5 6. $\begin{bmatrix} 3a & 3 \\ 0 & 0 \end{bmatrix}$

7. 3 8. 2 9. (a) $\begin{bmatrix} 1 & 0 \\ 0 & 1 \end{bmatrix}$ (b) $\begin{bmatrix} -\cos 2\theta & 0 \\ 0 & \cos 2\theta \end{bmatrix}$ (c) $\begin{bmatrix} -\cos 2\theta & 0 \\ 0 & \cos 2\theta \end{bmatrix}$ (d) $\begin{bmatrix} 0 & 0 \\ 0 & 0 \end{bmatrix}$ 10. (a) $\begin{bmatrix} 1 & 0 \\ 0 & 1 \end{bmatrix}$

(b) $\begin{bmatrix} -\cos 2\theta & 2\sin \theta \\ -2\cos \theta & \cos 2\theta \end{bmatrix}$ 11. $a = 3, b = 4$ 12. $x = 1$

EXERCISE 25.1.2

1. (i) $\begin{bmatrix} 5 & -4 \\ 2 & -1 \end{bmatrix}$ (ii) $\begin{bmatrix} 6 & -8 \\ -15 & 26 \end{bmatrix}$ (iii) $\begin{bmatrix} -7 & 17 \\ 3 & 3 \end{bmatrix}$ (iv) $\begin{bmatrix} -15 & -10 \\ -10 & -36 \end{bmatrix}$ (v) $\begin{bmatrix} 19 & 89 \\ 6 & 3 \\ 1 & 11 \\ 8 & 2 \end{bmatrix}$ (vi) $\begin{bmatrix} 2.6 & 5.5 \\ -8.55 & 0 \end{bmatrix}$

(vii) $\begin{bmatrix} 12 & -4 & 2 \\ 6 & 0 & -3 \end{bmatrix}$ (viii) $\begin{bmatrix} -9 & 3 & 2 \\ 4 & -2 & -2 \end{bmatrix}$ (ix) $\begin{bmatrix} 7 & 3 & 7 \\ 6 & 2 & 3 \\ 13 & 5 & 29 \\ 3 & 3 & 3 \end{bmatrix}$ (x) $\begin{bmatrix} 1.6 & -0.7 & 3.8 \\ -3.9 & -4.2 & -5.7 \end{bmatrix}$ (xi) $\begin{bmatrix} 11 & -2 \\ 11 & 3 \\ 1 & -7 \end{bmatrix}$

(xii) $\begin{bmatrix} 7 & 5 \\ 21 & -26 \\ 6 & 4 \end{bmatrix}$ (xiii) $\begin{bmatrix} 12 & 6 & 2 \\ 12 & 1 & 4 \\ 21 & 3 & 6 \end{bmatrix}$ (xiv) $\begin{bmatrix} -5 & 6 & 1 \\ 4 & -4 & -12 \\ -1 & 4 & 2 \end{bmatrix}$ (xv) $\begin{bmatrix} -7 & 2 & 13 \\ 8 & -8 & -17 \\ -4 & -11 & 4 \end{bmatrix}$ (xvi) $\begin{bmatrix} 25 & -50 & 4 \\ 2 & 3 & 4 \\ -79 & 83 & 27 \\ -4 & -6 & 4 \\ -2 & 11 & 3 \\ 6 & 4 & 4 \end{bmatrix}$

(xvii) $\begin{bmatrix} x + 3x^2 & -x^2 + 1 \\ 2x + 5x^2 & -x^2 + 2 \\ -x^2 + 5x & -2x \end{bmatrix}$ (xviii) $\begin{bmatrix} a + 2x^2 - a^2 & 2a + 4x - 2x^2 + 2a \\ a - 2ax & -2a & 3a + 2ax \\ 0 & 2a & -ax - x \end{bmatrix}$

2. (i) $\begin{bmatrix} 1 & 0 \\ 0 & 1 \end{bmatrix}$ (ii) $\begin{bmatrix} -1 & 0 \\ 0 & -1 \end{bmatrix}$, $\begin{bmatrix} 1 & 0 \\ 0 & 1 \end{bmatrix}$, $\begin{bmatrix} -1 & 0 \\ 0 & -1 \end{bmatrix}$ (iii) $\begin{bmatrix} -1 & 0 \\ 0 & -1 \end{bmatrix}$ if n is odd and $\begin{bmatrix} 1 & 0 \\ 0 & 1 \end{bmatrix}$ if n is even.

3. (i) $\begin{bmatrix} 0 & 3 & 4 & 2 \\ 1 & 0 & 0 & 6 \\ 1 & 2 & 0 & 2 \\ 4 & 3 & 0 & 0 \end{bmatrix}$ $\begin{bmatrix} 120 \\ 105 \\ 110 \\ 100 \end{bmatrix}$ (ii) $\begin{bmatrix} 955 \\ 720 \\ 530 \\ 795 \end{bmatrix}$ (iii) Loading costs for each depot. **4.** $\begin{bmatrix} 0 & -1 \\ 1 & 0 \end{bmatrix}$ $n = 4$.

5. (a) 2×1 (b) $-$ (c) 3×2 (d) $-$ (e) $-$ (f) 1×3 **6.** (a) No (b) Yes (c) $AB = BA$ **7.** $\begin{bmatrix} n \\ 12 - 5n \\ 4 \end{bmatrix}$, $n \in \mathbb{R}$

8. $a = -0.4$, $b = 2$ **9.** B **10.** (a) $\begin{bmatrix} 1 & 0 \\ 0 & 1 \end{bmatrix}$, $S^3 = S$ (b) $\begin{bmatrix} 1 & 0 \\ 0 & 1 \end{bmatrix}$, $S^{2n+1} = S$ (c) 0, $\pm 2\pi$, $\pm 4\pi$, ...

11. $x = 0 = y$, $w = z$ **12.** 2, 6 **13.** $A = \begin{bmatrix} 1 & 0 & 1 \\ 1 & -1 & p^2 \\ p & 1 & -(2p+1) \end{bmatrix}$, $a = 2p$, $b = p - 1$, $c = p$

15. $x = 3$, $y = -2$, $a = -9$, $b = -4$

17. (a) $A^2 = \begin{bmatrix} 2 & 1 \\ 1 & 1 \end{bmatrix}$, $A^3 = \begin{bmatrix} 3 & 2 \\ 2 & 1 \end{bmatrix}$, $A^4 = \begin{bmatrix} 5 & 3 \\ 3 & 2 \end{bmatrix}$ (b) $A^n = \begin{bmatrix} F_{n+1} & F_n \\ F_n & F_{n-1} \end{bmatrix}$

EXERCISE 25.2

1. (i) -4 (ii) 9 (iii) 12 (iv) 2 (v) 15 (vi) $\frac{4}{9}$ (vii) 0.5 (viii) 4 (ix) 1 (x) $x^2 - 2$ (xi) 0 (xii) 1

2. (i) $\begin{bmatrix} 0 & 1 \\ 1 & 1 \\ 4 & 2 \end{bmatrix}$ (ii) $\begin{bmatrix} -1 & -1 \\ 2 & 3 \\ 2 & 2 \end{bmatrix}$ (iii) $\begin{bmatrix} -\frac{3}{14} & \frac{1}{7} \\ -\frac{2}{7} & -\frac{1}{7} \end{bmatrix}$ (iv) $\begin{bmatrix} 1 & 0 \\ -\frac{1}{2} & -\frac{1}{4} \end{bmatrix}$ (v) $\begin{bmatrix} 0 & 1 \\ -1 & -4 \end{bmatrix}$ (vi) no inverse

(vii) $\begin{bmatrix} -\frac{1}{5} & \frac{1}{5} \\ -\frac{4}{15} & \frac{1}{15} \end{bmatrix}$ (viii) $\begin{bmatrix} 1 & -\frac{1}{2} \\ 1 & -\frac{3}{4} \end{bmatrix}$ (ix) $\begin{bmatrix} -4 & -1 \\ 1 & -1 \end{bmatrix}$ (x) $\begin{bmatrix} 1 & 3 \\ 1 & 0 \end{bmatrix}$ (xi) $\begin{bmatrix} 2 & 3 \\ 2 & -3 \end{bmatrix}$ (xii) $\begin{bmatrix} 3 & 3 \\ 1 & -2 \end{bmatrix}$ (xiii) $\begin{bmatrix} 3 & -4 \\ -2 & 3 \end{bmatrix}$

(xiv) $\begin{bmatrix} \frac{3}{x} & \frac{1}{x} \\ -2 & 1 \end{bmatrix}$ (xv) $\begin{bmatrix} -1 & 1 \\ \frac{3}{x} & -\frac{2}{x} \end{bmatrix}$ (xvi) $\frac{x-1}{-x^3+x^2+2x-1} \begin{bmatrix} \frac{1}{x-1} & 1-x \\ -x-1 & x \end{bmatrix}$ **3.** -2 , **2** **4.** -24 **5.** $-\frac{1}{2}$

6. (a) -29 (b) 80 (c) 0 (d) -11 **7.** (a) $\frac{1}{29} \begin{bmatrix} 5 & -7 & 13 \\ -7 & 4 & 5 \\ 4 & 6 & -7 \end{bmatrix}$ (b) $\frac{1}{80} \begin{bmatrix} 9 & 10 & 7 \\ -1 & -10 & 17 \\ 14 & -20 & 2 \end{bmatrix}$ (c) does not exist.

(d) $\frac{1}{11} \begin{bmatrix} 2 & 3 & -1 \\ 5 & 2 & 3 \\ 4 & 6 & 9 \end{bmatrix}$ **8.** -5 $\frac{1}{5} \begin{bmatrix} 1 & -2 & 4 \\ -1 & 2 & 1 \\ 2 & 1 & -2 \end{bmatrix}$ **9.** $p = 2$ $\frac{1}{35} \begin{bmatrix} 5 & 4 & 7 \\ 10 & -6 & 7 \\ 5 & 11 & -7 \end{bmatrix}$ **11.** $-\frac{23}{4} \frac{1}{23} \begin{bmatrix} -15 & 6 & -8 \\ 26 & 8 & 20 \\ -4 & -3 & 4 \end{bmatrix}$

12. $x = 1$

13. $-2 \begin{bmatrix} 11 & -9 & -10 \\ -1 & 1 & 1 \\ 8 & -\frac{13}{2} & -\frac{15}{2} \end{bmatrix}$ **15.** (a) $AB = \begin{bmatrix} 5 & 0 & 0 \\ 0 & 5 & 0 \\ 0 & 0 & 5 \end{bmatrix}$, $A^{-1} = \frac{1}{5} \begin{bmatrix} 1 & 2 & 0 \\ 0 & 1 & 2 \\ 1 & 0 & 1 \end{bmatrix}$

(b) $AB = \begin{bmatrix} 1 & 0 & 0 \\ 0 & 1 & 0 \\ 0 & 0 & 1 \end{bmatrix}$, $A^{-1} = \begin{bmatrix} 2 & 3 & 5 \\ 1 & 2 & 3 \\ 1 & -1 & 1 \end{bmatrix}$ (c) $AB = \begin{bmatrix} 3 & 0 & 0 \\ 0 & 3 & 0 \\ 0 & 0 & 3 \end{bmatrix}$, $A^{-1} = \frac{1}{3} \begin{bmatrix} 1 & 1 & 1 \\ 2 & -1 & 2 \\ 1 & 3 & 2 \end{bmatrix}$

16. (a) 0, 1, 3 (b) -2.0 **18.** (d) $\alpha = 14$, $\beta = 3$ (e) 1 (or 0, but we will assume that A is not singular). **21.** (a) -2 (b) $k = -1$

EXERCISE 25.3

1. (i) (1, -1) (ii) (4, -3) (iii) (-3, -3) (iv) (-2, -1) (v) (2, 5) (vi) (1, 0) (vii) (0, 3) (viii) (-2, 4)

(ix) (0.5, 2) (x) (2, 0.6) (xi) (-1, -3) (xii) (-2, 2) (xiii) $\left(3, \frac{1}{3}\right)$ (xiv) (5, -2) (xv) (5, 4)

2. (i) $a = -2$, $b = -4$ (ii) $a = -2$, $b \neq -4$ **3.** ± 2 **4.** (a) (1, -3, 2) (b) (5, -3, -1) (c) (-0.6, -4.2, -1.4)

5. (78, 29, -47) **6.** $\left(\frac{4}{11}, \frac{9}{11}, \frac{7}{11}\right)$ **7.** (a) $m \neq -1$, 2 (b) $m = -1$ (c) $m = 2$ **8.** (a) $p \neq 1.2$

(b) $p = 1.2$, $k \neq 6$ (c) $p = 1.2$, $k = 6$ **9.** (a) (4, 0) (b) \emptyset (c) (2, -3) (d) (2, 3, -2)

(e) $(4 + 2\lambda, 3 - \lambda, \lambda)$ (f) (1, 2, -2) (g) \emptyset (h) $(2\lambda - 1, \lambda, \lambda)$ (i) \emptyset

10. $y = x^2 + 6x - 14$ **11.** $y = -\left(\frac{\lambda}{2} + 6\right)x^2 + \left(\frac{\lambda}{2} + 13\right)x + \lambda$ **12.** (a) i. $\left(-\frac{7\lambda}{11}, -\frac{\lambda}{11}, \lambda\right)$

ii. $\left(\frac{7-7\lambda}{11}, \frac{1-\lambda}{11}, \lambda\right)$ (b) (0, 0, 0) **13.** (a) 1, -2 (b) i. 1, -2 ii. neither 1 nor -2 iii. \emptyset

EXERCISE 26.1

1. vector **2.** scalar **3.** scalar **4.** vector **5.** vector **6.** vector **7.** scalar **8.** scalar

EXERCISE 26.2

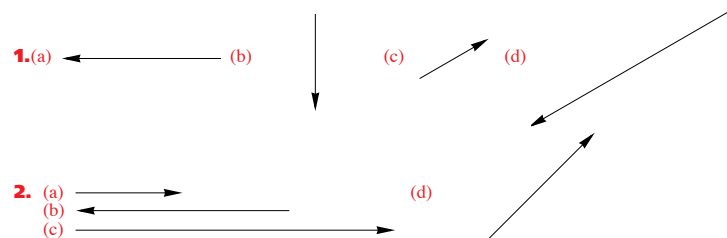

3. (a) {a, b, e, g, u}; {d, f} (b) {d, f}; {a, c}; {b, e} (c) {a, g}; {c, g} (d) {d, f}; {b, e} (e) {d, f}; {b, e}; {a, c, g}

4.

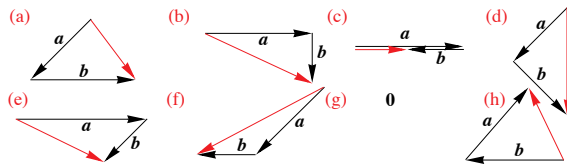

5. (a) AC (b) AB (c) AD (d) BA (e) 0

6. (a) Y (b) N (c) Y (d) Y (e) N

7. (a) i. (b) i. (c) i.

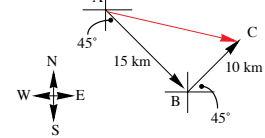

ii. $\sqrt{325}$

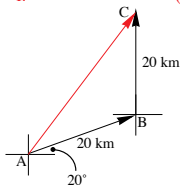

ii. $20\sqrt{2}(1 - \cos 110^\circ)$

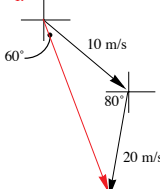

ii. $10\sqrt{5} - 4\cos 110^\circ$

8. 72.11 N, E $33^\circ 41'$ N 9. 2719 N along river 10. (b) i. 200 kph N ii. 213.6 kph, N $7^\circ 37'$ W

11. i. 200 ii. 369.32

EXERCISE 12.3

1. (a) $c - a$ (b) $b - c$ (c) $\frac{1}{2}(b + a)$ 2. (a) $b - a$ (b) $b - 2a$ (c) $2b - 3a$ (d) $\frac{1}{2}(b + 2a)$

3. (a) 0 (b) PS (c) AY (d) 6OC 4. (a) $\frac{1}{2}(b + a)$ (b) $\frac{1}{3}(2b + a)$ (c) $\frac{1}{4}(a + b + 2c)$

7. (a) $c - b$ (b) $c + a$ (c) $a + c - 2b$ 8. (a) $2\sqrt{21}$ (b) $2\sqrt{26}$ 15. $m = \frac{13}{23}$, $n = \frac{50}{23}$ 16. $m = \frac{4}{3}$

EXERCISE 12.4

1. (i) $4i + 28j - 4k$ (ii) $12i + 21j + 15k$ (iii) $-2i + 7j - 7k$ (iv) $-6i - 12k$

2. (i) $3i - 4j + 2k$ (ii) $-8i + 24j + 13k$ (iii) $18i - 32j + k$ (iv) $-15i + 36j + 12k$

3. (i) $\begin{pmatrix} 11 \\ 0 \\ 8 \end{pmatrix}$ (ii) $\begin{pmatrix} -27 \\ 1 \\ -22 \end{pmatrix}$ (iii) $\begin{pmatrix} -3 \\ -6 \\ 12 \end{pmatrix}$ (iv) $\begin{pmatrix} 16 \\ -1 \\ 14 \end{pmatrix}$ 4. $\begin{pmatrix} -5 \\ 3 \end{pmatrix}$ 5. $\begin{pmatrix} -2 \\ 3 \end{pmatrix}$, $(-2, 3)$

6. (i) $8i - 4j - 28k$ (ii) $-19i - 7j - 16k$ (iii) $-17i + j + 22k$ (iv) $40i + 4j - 20k$

7. (i) $\begin{pmatrix} 20 \\ 1 \\ 25 \end{pmatrix}$ (ii) $\begin{pmatrix} 12 \\ 2 \\ 16 \end{pmatrix}$ (iii) $\begin{pmatrix} -4 \\ -38 \\ -32 \end{pmatrix}$ (iv) $\begin{pmatrix} -20 \\ -22 \\ -40 \end{pmatrix}$ 8. A = -4, B = -7

9. i. (2, -5) ii. (-4, 3) iii. (-6, -5) 10. Depends on basis used. Here we used: East as i , North j and vertically up k (b) $D = 600i - 800j + 60k$, $A = -1200i - 300j + 60k$ (c) $1800i - 500j$

EXERCISE 12.5

1. (i) $\sqrt{10}$ (ii) $5\sqrt{2}$ (iii) $\sqrt{30}$ (iv) $3\sqrt{5}$ (v) $\sqrt{53}$ (vi) $\sqrt{41}$ (vii) $\sqrt{14}$ (viii) $\sqrt{17}$

2. (i) $\frac{1}{\sqrt{2}}(i + j)$ (ii) $\frac{1}{\sqrt{41}}(4i + 5j)$ (iii) $\frac{1}{\sqrt{5}}(-i - 2j)$ (iv) $\frac{1}{\sqrt{46}}(i + 6j - 3k)$ (v) $\frac{1}{\sqrt{5}}(i + 2k)$

(vi) $\frac{1}{\sqrt{17}}(2i - 2j - 3k)$ (vii) $\frac{1}{3}\begin{pmatrix} 2 \\ 1 \\ 2 \end{pmatrix}$ (viii) $\frac{1}{3\sqrt{3}}\begin{pmatrix} -1 \\ 5 \\ 1 \end{pmatrix}$ 3. i. Depends on the basis: $-3i + 4j + k$

or $-4i - 3j + k$ ii. $\sqrt{26}$ 4. (a) $\sqrt{3}(i - j + k)$ (b) $\frac{1}{4}(3i - j + \sqrt{2}k)$ 5. $\pm\sqrt{11}$ 6. $\sqrt{13}$

EXERCISE 12.6

1. (a) 4 (b) -11.49 (c) 25 2. (i) 12 (ii) 27 (iii) -8 (iv) -49 (v) 4 (vi) -21 (vii) 6 (viii) -4 (ix) -10 3. (i) 79° (ii) 108° (iii) 55° (iv) 50° (v) 74° (vi) 172° (vii) 80° (viii) 58° 4. (i) -8 (ii) 0.5

5. (a) -6 (b) 2 (c) not possible (d) 5 (e) not possible (f) 0 6. (a) $4 - 2\sqrt{3}$ (b) $2\sqrt{3} - 4$ (c) $14 - 2\sqrt{3}$ (d) not possible 7. 1 8. 105.2° 9. $x = -\frac{16}{7}$, $y = -\frac{44}{7}$ 10. $\pm\frac{1}{\sqrt{11}}(-i + j + 3k)$

12. (a) $\lambda(-16i - 10j + k)$ (b) e.g. $i + j + \frac{3}{7}k$ 14. $a \perp b - c$ if $b \neq c$ or $b = c$ 15. (a) $\begin{pmatrix} 3 \\ 5 \\ 5 \end{pmatrix}$

(b) $\left(\frac{\sqrt{2}}{2}, \frac{1}{2}, -\frac{1}{2}\right)$ 16. (a) $\left(-\frac{2}{3}, \frac{2}{3}, \frac{1}{3}\right)$ (b) $131.8^\circ, 48.2^\circ, 70.5^\circ$ 18. (a) $\frac{1}{3}$ (b) $\frac{1}{\sqrt{3}}$

19. (a) (b) $\hat{u} = \frac{1}{\sqrt{10}}(3i - j)$, $\hat{v} = \frac{1}{\sqrt{5}}(i + 2j)$ 20. $\frac{1}{2}(-i + j + \sqrt{2}k)$ (c) 81.87°

25. (a) Use i as a 1 km eastward vector and j as a 1 km northwards vector (b) $\overrightarrow{WD} = 4i + 8j$, $\overrightarrow{WS} = 13i + j$ and $\overrightarrow{DS} = 9i - 7j$ (c) $\frac{1}{\sqrt{80}}(4i + 8j)$ (d) $\frac{d}{\sqrt{80}}(4i + 8j)$ (e) $3i + 6j$

EXERCISE 12.7.1

1. (a) i , $r = i + 2j$ ii. $r = -5i + 11j$ iii. $r = 5i - 4j$ (b) line joins (1, 2) & (5, -4)

2. (a) $r = 2i + 5j + \lambda(3i - 4j)$ (b) $r = -3i + 4j + \lambda(-i + 5j)$ (c) $r = j + \lambda(7i + 8j)$

(d) $r = i - 6j + \lambda(2i + 3j)$ (e) $r = \begin{pmatrix} -1 \\ -1 \end{pmatrix} + \lambda\begin{pmatrix} -2 \\ 10 \end{pmatrix}$ or $r = -i - j + \lambda(-2i + 10j)$

(f) $r = \begin{pmatrix} 1 \\ 2 \end{pmatrix} + \lambda\begin{pmatrix} 5 \\ 1 \end{pmatrix}$ or $r = i + 2j + \lambda(5i + j)$

3. (a) $r = 2i + 3j + \lambda(2i + 5j)$ (b) $r = i + 5j + \lambda(-3i - 4j)$ (c) $r = 4i - 3j + \lambda(-5i + j)$

4. (a) $r = 9i + 5j + \lambda(i - 3j)$ (b) $r = 6i - 6j + \lambda(-4i - 2j)$ (c) $r = -i + 3j + \lambda(-4i + 8j)$

(d) $r = i + 2j + \mu\left(\frac{1}{2}i - \frac{1}{3}j\right)$ 5. (a) $\begin{matrix} x = -8 + 2\mu \\ y = 10 + \mu \end{matrix}$ (b) $\begin{matrix} x = 7 - 3\mu \\ y = 4 - 2\mu \end{matrix}$ (c) $\begin{matrix} x = 5 + 2.5\mu \\ y = 3 + 0.5\mu \end{matrix}$

- (d) $x = 0.5 - 0.1t$
 $y = 0.4 + 0.2t$ **6.** (a) $\frac{x-1}{3} = y-3$ (b) $\frac{x-2}{-7} = \frac{y-4}{-5}$ (c) $x+2 = \frac{y+4}{8}$
- (d) $x-0.5 = \frac{y-0.2}{-11}$ (e) $x = 7$ (f) $y = 6$ **7.** (a) $r = 2j + t(3i + j)$ (b) $r = 5i + t(i + j)$
- (c) $r = -6i + t(2i + j)$ **8.** (a) $6i + 13j$ (b) $-\frac{16}{3}i - \frac{28}{3}j$ **9.** $r = 2i + 7j + t(4i + 3j)$
- 11.** (a) (4, -2), (-1, 1), (9, -5) (b) -2 (d) $r = 4i - 2j + \lambda(-5i + 3j)$ (e) i. $M \parallel L$ ii. $M = L$
- 12.** $4x + 3y = 11$ **13.** (a) $\frac{-3}{\sqrt{13}}, \frac{2}{\sqrt{13}}$ (b) $\frac{4}{5}, \frac{3}{5}$ **14.** (b) ii. & iii. **15.** (-83, -215)
- 16.** $r = \frac{k}{7}(19i + 20j)$ **17.** (a) $(\frac{92}{11}, \frac{31}{11})$ (b) \emptyset (c) Lines are coincident, all points are common.

EXERCISE 12.7.2

- 1.** (a) $r = 2i + j + 3k + t(i - 2j + 3k)$ (b) $r = 2i - 3j - k + t(-2i + k)$
- 2.** (a) $r = 2i + 5k + t(i + 4j + 3k)$ (b) $r = 3i - 4j + 7k + t(4i + 9j - 5k)$
- (c) $r = 4i + 4j + 4k + t(7i + 7k)$ **3.** (a) $\frac{x}{3} = \frac{y-2}{4} = \frac{z-3}{5}$ (b) $\frac{x+2}{5} = \frac{z+1}{-2}, y = 3$
- (c) $x = y = z$ **4.** $y = 2 + 2t$ $r = \begin{pmatrix} 5 \\ 2 \\ 6 \end{pmatrix} + t \begin{pmatrix} -7 \\ 2 \\ -4 \end{pmatrix}$ $\frac{x-5}{-7} = \frac{y-2}{2} = \frac{z-6}{-4}$ **5.** $(\frac{13}{5}, \frac{23}{5}, 0)$
- $x = 5 - 7t$
 $z = 6 - 4t$
- $x = 2 + 3t$ $x = 1 + 1.5t$ $x = 3 - t$ $x = 1 + 2t$
- 6.** (a) $y = 5 + t$ (b) $y = t$ (c) $y = 2 - 3t$ (d) $y = 3 + 2t$
- $z = 4 + 0.5t$ $z = 4 - 2t$ $z = 4 + 2t$ $z = 2 + 0.5t$
- 7.** (a) $\frac{x-4}{3} = \frac{y-1}{-4} = \frac{z+2}{-2}$ (b) $x = 2, y = \frac{z-1}{-3}$ **9.** (a) $\frac{x+1}{2} = y - 3 = \frac{z-5}{-1}$
- (b) $\frac{x-2}{2} = \frac{z-1}{-2}, y = 1$ **10.** (a) (1, -1, 0) (b) $a = 15, b = -11$

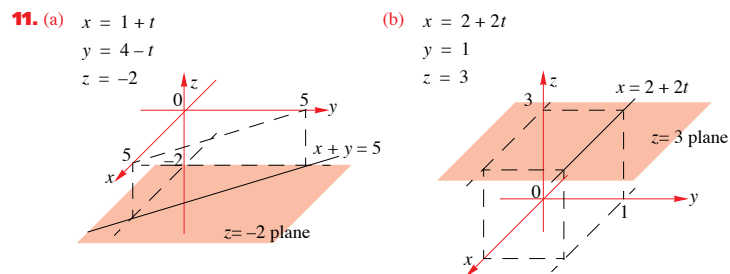

$r = \begin{pmatrix} 1 \\ 0.5 \\ 2 \end{pmatrix} + t \begin{pmatrix} 2 \\ -1.5 \\ 1 \end{pmatrix}$. Line passes through (1, 0.5, 2) and is parallel to the vector $2i - \frac{3}{2}j + k$

- 13.** (a) 54.74° (b) 82.25° (c) 57.69° **14.** (a) (4, 10.5, 15) (b) Does not intersect.

- 15.** (a) L: $x = \frac{y-2}{2} = \frac{z}{5}$, M: $\frac{x+1}{2} = \frac{y+1}{3} = \frac{z-1}{-2}$ (b) \emptyset (c) 84.92° (d) i. (0, 2, 0) ii. $(0, \frac{1}{2}, 0)$

- 18.** $\frac{x}{4} = \frac{y}{9} = \frac{z}{3}$ **19.** $k = -\frac{7}{2}$ **20.** 64° **21.** 3 or -2 **22.** $12i + 6j - 7k$ (or any multiple thereof) **23.** Not parallel. Do not intersect. Lines are skew.

EXERCISE 27.1.1

- 1.** (a) 5 (b) $4\sqrt{3}$ (c) 0 (d) 6 (e) 0

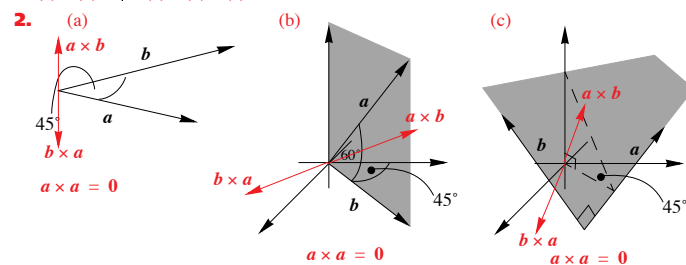

- 3.** i. $2\sqrt{91}$ ii. 16 **4.** $56^\circ 27'$ **5.** $3\sqrt{5}$ **6.** i. $2\sqrt{3}$ ii. $5\sqrt{3}$

EXERCISE 27.1.2

- 1.** i. $-12i + 4k$ ii. $10i - 2j - 2k$ iii. $18i - 9j$ iv. $10i + 2j - 2k$ v. $-6i + 9j + 8k$
- vi. $20i - 13j - 4k$ **2.** $-10i + 6j - 2k$ **5.** (a) 0 **6.** $\frac{-6i + 2j - 2k}{\sqrt{11}}$ **7.** (a) λk
- (b) $\lambda(9i - 3j + 9k)$ **8.** (a) 90° (b) 79.1° **12.** They must be parallel.

EXERCISE 27.1.3

- 1.** (a) $\sqrt{54}$ (b) $\sqrt{234}$ **2.** (a) $\frac{1}{2}(-3i - 13j + 29k)$ (b) $\frac{1}{2}\sqrt{1019}$ (c) 67.84° **3.** $\frac{1}{2}\sqrt{2331}$ **4.** $12\sqrt{2}$
- 5.** $43^\circ 36'$ **6.** $\sqrt{293}$ sq. units **7.** $\frac{1}{2}\sqrt{35}$ **9.** (a) $\mathbf{OA} = \cos \alpha i + \sin \alpha j$, $\mathbf{OB} = \cos \beta i + \sin \beta j$
- 12.** 66 cubic units **13.** (b) $k = 0.5$

EXERCISE 27.2.1

- 1.** (a) $r = i + k + \lambda(3i + 2j + k) + \mu(-2i - j + k)$
- (b) $r = -i + 2j + k + \lambda(i - j + 2k) + \mu(-i - j + k)$
- (c) $r = 4i + j + 5k + \lambda(2i + 2j - k) + \mu(2i - j + 3k)$
- (d) $r = 2i - 3j - k + \lambda(-3i + j - 2k) + \mu(i - 2j + \frac{1}{2}k)$
- 2.** (a) $3x - 5y + z = 4$ (b) $x - 3y - 2z = -9$ (c) $5x - 8y - 6z = -18$ (d) $7x + y - 10z = 21$
- 3.** i. (a) $r = \begin{pmatrix} 2 \\ 3 \\ 4 \end{pmatrix} + \lambda \begin{pmatrix} -3 \\ -1 \\ -3 \end{pmatrix} + \mu \begin{pmatrix} -2 \\ 2 \\ 2 \end{pmatrix}$ (b) $x + 3y - 2z = 3$ ii. (a) $r = \begin{pmatrix} 3 \\ -1 \\ 5 \end{pmatrix} + \lambda \begin{pmatrix} -2 \\ 5 \\ -11 \end{pmatrix} + \mu \begin{pmatrix} -1 \\ 4 \\ -1 \end{pmatrix}$

(b) $13x + 3y - z = 31$ **4.** (a) i. $\mathbf{r} = \begin{pmatrix} 2 \\ -2 \\ 3 \end{pmatrix} + \lambda \begin{pmatrix} 2 \\ -1 \\ -1 \end{pmatrix} + \mu \begin{pmatrix} 3 \\ 1 \\ 2 \end{pmatrix}$ ii. $\mathbf{r} = \lambda \begin{pmatrix} 2 \\ -1 \\ -1 \end{pmatrix} + \mu \begin{pmatrix} 3 \\ 1 \\ 2 \end{pmatrix}$

(b) i. $x + 7y - 5z = -27$ ii. $x + 7y - 5z = 0$ (c) $-i - 7j + 5k$ (d) Coefficients are just negative of those in (b)

EXERCISE 27.2.2

1. (a) $2x - y + 5z = 7$ (b) $-4x + 6y - 8z = 34$ (c) $-x + 3y - 2z = 0$ (d) $5x + 2y + z = 0$

2. (c) & (d) **3.** (a) $-3x - y + 2z = 3$ (b) $y = 2$ (c) $2x + 2y - z = -3$ **4.** (a) 29.5° (b) 70°

(c) 90° (d) 11° **5.** (a) 83° (b) 50° (c) 49° **6.** (a) $2x + y + 2z = 12$ (b) $8x + 17y - z = 65$

7. $x - 2y + 3z = -2$ **8.** $3x - 2y + 5z = -2$ **9.** $a = \frac{24}{13}$, $b = \frac{18}{13}$

10. (a) $\mathbf{r} = 3i + 2j + k + t(2i + 5j + 5k)$ (b) $3i + 2j + k$ (c) 49.8°

EXERCISE 27.2.3

1. (a) $2x + 7y - 6z = 33$; $\mathbf{r} \cdot \begin{pmatrix} 2 \\ 7 \\ -6 \end{pmatrix} = 33$ (b) $x - 2y = 0$; $\mathbf{r} \cdot \begin{pmatrix} 1 \\ -2 \\ 0 \end{pmatrix} = 0$

2. $3x - y - z = 2$ **5.** (a) 3 (b) $\frac{5}{3}$ (c) $\sqrt{11}$ (d) $\frac{20}{\sqrt{21}}$ **6.** $3x + 4y - 5z = -4$

7. $2x + 3y - 3z = 5$ **9.** $x + 5y - 6z = -19$

EXERCISE 27.3.1

1. (a) $(7, 5, -3)$ **2.** Lines that intersect are (b) and (c); $(7, -4, 10)$; 46.7° **3.** $(5, -2, -3)$ **4.** $(4, 0, 6)$

EXERCISE 27.3.2

1. (a) i. $(7, 4, 2)$ ii. 36.3° (b) i. $(5, 2, -5)$ i. 10.1° (c) i. $(6, -5, -7)$ ii. 4.4° (d) i. $(3, -1, 1)$ ii. 29.1°

2. (a) $(\frac{3}{2}, \frac{5}{2}, 2)$ (b) $(0, 4, 1)$ **3.** (a) Plane is parallel to the z -axis slicing the x - y plane on the line $x + y = 6$. (b) $x = 4$ forms a plane. $y = 2z$ is in this plane parallel to the y - z plane. $(4, 2, 1)$ **4.** 13

EXERCISE 27.3.3

1. (a) $x = -2y + 9 = -2z - 3$ or $\frac{x+3}{-2} = y - 6 = z$; $22^\circ 12'$ (b) $\frac{21 - 10x}{-9} = y = \frac{7 - 10z}{7}$

or $\frac{7x - 29}{-11} = \frac{7y + 9}{-6} = z$; $70^\circ 48'$ (c) planes parallel

(d) $x = 4$, $z = -2 - 2y$; $65^\circ 54'$ **3.** $73^\circ 42'$

EXERCISE 27.3.4

1. E.g. the faces of a triangular prism. **2.** (a) $4 - 2x = \frac{2y - 4}{-5} = z$ or $\frac{x}{1} = \frac{y + 8}{5} = \frac{z - 4}{-2}$

3. (a) $5 - 4x = y = \frac{8 - 4z}{7}$ or $\frac{x}{1} = \frac{y - 5}{-4} = \frac{z + 6}{7}$ **4.** (a) no solution (b) unique solution

$(5, 1, 4)$ (c) unique solution $(5, 1, -3)$ (d) intersect on plane $\frac{5x + 19}{-8} = \frac{5y - 13}{1} = z$

5.

(a) $x = 4t$ $x = 4s$ (b) $y = 2t$ $y = 2s$ $(2, 1, 1.5)$ (c) $3x + 6y - 4z = 12$
 $z = 3t$ $z = 3 - 3s$

(d) $(\frac{8}{3}, \frac{4}{3}, 1)$ $58^\circ 52'$ (e) 59.2°

6. None of these planes are parallel but the lines of intersection of pairs of planes are skew.

7. $k = 2$; $\mathbf{r} = \begin{pmatrix} 0 \\ 3.5 \\ 1.5 \end{pmatrix} + t \begin{pmatrix} 1 \\ -2.5 \\ -0.5 \end{pmatrix}$ or $\mathbf{r} = \begin{pmatrix} 3 \\ -4 \\ 0 \end{pmatrix} + \lambda \begin{pmatrix} -2 \\ 5 \\ 1 \end{pmatrix}$ **8.** (a) $-2i - 2j + 4k$ (b) $\mathbf{r} = t \begin{pmatrix} -1 \\ -1 \\ 2 \end{pmatrix}$

(c) i. 5 iii. not 5

9. (b) $(a - b + c, a + b - c, -a + b + c)$ (c) $(\frac{1}{a} - \frac{1}{b} + \frac{1}{c}, \frac{1}{a} + \frac{1}{b} - \frac{1}{c}, -\frac{1}{a} + \frac{1}{b} + \frac{1}{c})$

10. (a) 2, 3 (b) 3 (c) For $k = 2$, $x - 1 = 4 - y = z$

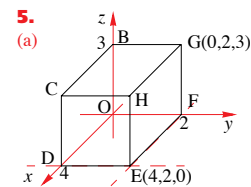

REVISION EXERCISES - SET A

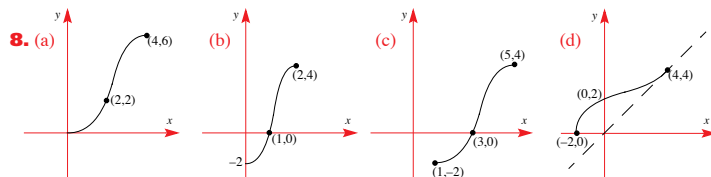
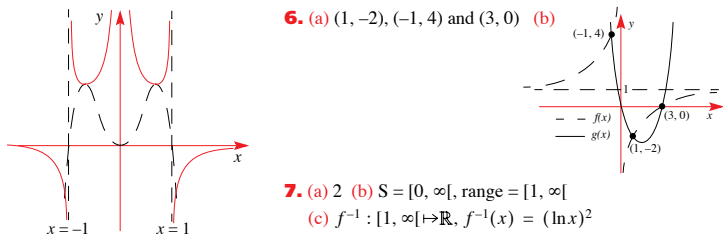
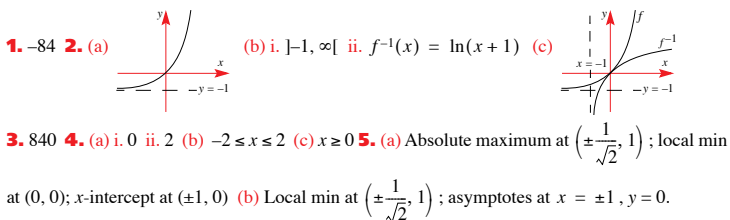

9. (a) i. 512 ii. 2 (b) i. $3x^2h + 3xh^2 + h^3$ ii. $3x^2 + 3xh + h^2$

10. (a) i. -1 or 6 ii. $\frac{3}{e-1}$ (b) i. $\mathbb{R} \setminus \{3\}$ ii. 0.2 iii. 0

11. (a) i. 2 or 6 ii. $\frac{1}{3}(e^2 - 4)$ (b) i. $0 < x < 1$ ii. \mathbb{R} iii. $\log_e 4 \approx 0.72$ iv. $\frac{e^{0.8}}{1 + e^{0.8}} \approx 0.69$

12. (a) $g(f(x)) = -\frac{2x}{1-x}, x \in \mathbb{R} \setminus \{\pm 1\}$ (b) $P = (2, 4)$

13. (a) i. $x = \frac{\ln 6}{\ln 3}$ ii. $\frac{15}{7}$ (b) $1 + \sqrt{3}$ (c) i. $f(g(x)) = \sqrt{\frac{1}{x^2} - 1}, g(f(x)) = \frac{1}{x-1}$ ii. $[-1, 1] \setminus \{0\}$

14. 0.5 **15.** (a) $1, 1 + 2\sqrt{3}, 1 - 2\sqrt{3}$ (b) Cubic through $(1 - 2\sqrt{3}, 0), (1, 0), (1 + 2\sqrt{3}, 0)$ with local maximum at $(-1, 16)$ and local minimum at $(3, -16)$ (c) i. $k < 16$ ii. $k = \pm 16$ iii. $-16 < k < 16$

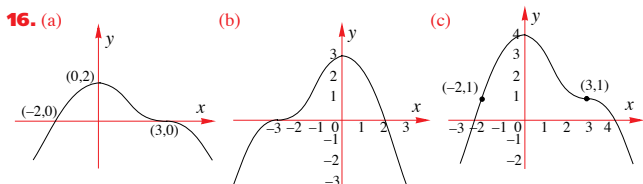

ANSWERS - 84

17. (a) $k = 0$ or 16 (b) $(2x-1)(3x+2)(x+3)$ (b) $0 < x < 3$ **18.** (a) $0 < x < 5$ (b) 70 (c) $-2, -\frac{1}{2}, 1$

19. (a) i. $P(x) = (x+3)(x-2)(2x-1)$ ii. $\left\{x \mid -3 < x < \frac{1}{2}\right\} \cup \{x \mid x > 2\}$ (b) i. 9 ii. -4

20. (a) ± 3 (b) $2x^3 - 2x^2 - x + 1 - \frac{4}{2x-1}$ (c) $-2 < x < 0$ or $x > 2$ **21.** (a) $\frac{1}{3} < x < 5$ (b) $y = -2x$

(c) $\frac{x-y}{x+y}$ **22.** $a = 1, b = 6$ **23.** (b) $x = -\frac{4}{9}, y = \frac{1}{9}$ **24.** (b) ii. $p^5 = 3 + 5p, p^{-5} = 5p - 8$

(c) $\frac{1}{2} < x < \frac{2}{3}$ or $x > \frac{3}{4}$ **25.** (a) $\frac{2}{9}$ (b) 59136 (c) $P(x) = (x+3)(x+1+\sqrt{2})(x+1-\sqrt{2})$

(d) $a = 2$ & $b = 1$ or $a = -1$ & $b = -8$ **26.** (b) $(x-1)^2(3-x)$ (c) $\{x \mid x < 1\} \cup \{x \mid 1 < x < 3\}$

27. (a) $-5 < k < 3$ (b) $p = 1, q = 0$ (c) i. $\{x \mid -6 < x < -3\} \cup \{x \mid -1 < x < 4\}$ ii. $\{x \mid x < 1\}$

28. $a = -\frac{3}{5}, b = -\frac{648}{25}, n = 10$ **29.** (a) ii. $\{\pm 1\}$ (b) i. $y = \sqrt{6(x-3)}$ ii. $x = 9, y = 6$

30. $1792x^5$ **31.** (a) $\frac{5}{2}, -\frac{3}{2}$ (b) $\frac{3}{2}, -\frac{1}{2}$ (c) $\frac{17}{2}$ **32.** (a) \mathbb{R} (b) $]-\infty, 4[$ (c) $]-\infty, 4[$ **33.** (b) $\frac{5}{8}$ sq. units

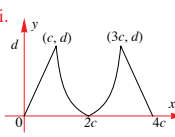
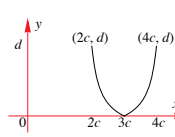
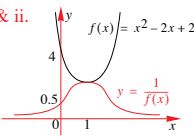
34. i.  ii.  **35.** (a) i. & ii. 

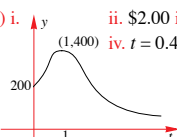
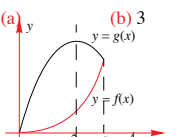
(b) i.  ii. \$2.00 iii. \$4 **36.** (a)  (b) 3 **37.** $g^{-1}(x) = e^{2x} + e, x \in \mathbb{R}$

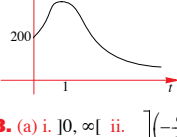
iv. $t = 0.42, 1.57$ 

38. (a) i. $]0, \infty[$ ii. $\left[\left(\frac{a}{eb}\right), \infty\right[$ (b)  (c) $(1, a \log_e b)$ (d) $x = b^{\frac{1}{2}-1}$

39. (a) $a = -36, b = 900$ (b) 20 (d) 1000 (e) $t > 1.95$ (f) 

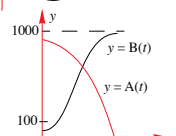
t	1	2	3.5	5
B(t)	131.04	527.02	957.23	997.78



40. (a) 150 cm (b) 138 cm (c) 94 hrs (d) $[0, 94]$ (e) $h^{-1}(x) = \frac{12.5 - \sqrt{t}}{0.13}$ (f) Use g.c. (g) 17.3 hrs

41. $x = -8, y = 11, z = -6$ **42.** (a)  (b) $]0, 2]$ (c) No ($x = 0$) **43.** 78

44. (a) 0 (b) $-\sqrt{2}$

(c) $r_f \not\subseteq d_g$ i.e., does not exist

ANSWERS - 85

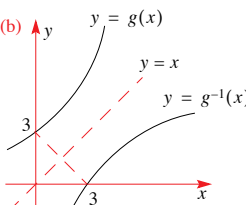
45. $-\frac{63}{8}x^5$ 46. (a) $g^{-1}(x) = -1 + \sqrt{x-2}, x \geq 2$ (b)  (c) no

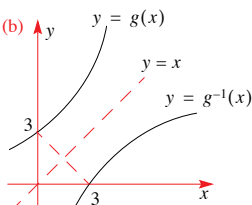

47. ii. $h(x) = 4 - x, x \geq 0$, range = $]-\infty, 4]$ 48. i. use g.c ii. $f^{-1}(x) = -\log_e(1-x), x < 1$

iii. use g.c 49. -10 50. $x = 7\lambda, y = \lambda, z = -11\lambda, \lambda \in \mathbb{R}$

51. (a) $r_g \subseteq d_f \Rightarrow f \circ g$ exists; $r_f \not\subseteq d_g \Rightarrow g \circ f$ doesn't exist (b) $x < -2$ or $x > 2$

52. $x = \lambda, y = 2 - \lambda, z = 3 + 2\lambda, \lambda \in \mathbb{R}$ 53. (a) $x = \lambda, y = \frac{8-3\lambda}{5}, z = \frac{6-\lambda}{5}, \lambda \in \mathbb{R}$

(c) $S =]-3, 2[$ 54. (a) $f^{-1}(x) = (2-x)^2, x < 2$ (b) $r_g \not\subseteq d_{f^{-1}} \Rightarrow f^{-1} \circ g$ does not exist;

$r_{f^{-1}} \subseteq d_g \Rightarrow g \circ f^{-1}$ exists (c) $F(x) = x - 2, x \leq 2$

55. (a) $t = 2$ or 3 (b) $t = 3$ (c) $x = 1 + \lambda, y = 4 - \lambda, z = \lambda, \lambda \in \mathbb{R}$

56. (a) i. 50 ii. $50e \approx 135.9$

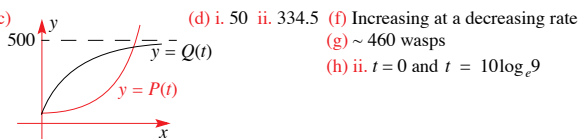

REVISION EXERCISES - SET B

1. (a) 189 (b) 99 (c) -96 (d) 36 2. (b) -65 3. (b) 23.9 km (c) 26.4° (d) 15.3 km (e) 107.5

4. (a) i. A: \$49000; B: \$52400; C: \$19200 ii. A: \$502400; B: \$506100; C: \$379400 (b) 4.6%

(c) i. 14 months ii. C never reaches its target 5. (a) $\frac{1}{2}\sqrt{26}$ (b) $-\frac{1}{2}(5-i)$ (c) $-\frac{1}{2}$ 6. (a) $r = 0.5$

(b) 62.5 cm 7. (b) $26^\circ 34'$ or 135° (c) $-2\sqrt{3}$ 8. (a) i. $\frac{1}{2}$ ii. $\frac{1}{3}$ iii. $\frac{1}{(k+1)(k-1)!}$

9. (b) $\frac{7\pi}{6}, \frac{11\pi}{6}, \frac{\pi}{2}$ 11. (a) 28 (b) i. $\frac{13}{36}$ ii. $\frac{17}{2}$ 12. (a) $3+4i$ or $-3-4i$ (b) $\text{cis}(2\theta)$

13. (a) $\frac{\pi}{3}, \frac{2\pi}{3}, \frac{4\pi}{3}, \frac{5\pi}{3}$ (b) $0, \frac{\pi}{2}, \pi, 2\pi$ (c) i. $R = 1, \alpha = \frac{\pi}{6}$ ii. $\left\{\frac{\pi}{2}, \frac{\pi}{6}\right\}$ 15. (a) max value is $\frac{17}{2}$

for $x = \frac{\pi}{2} + 2k\pi$ or $x = \frac{3\pi}{2} + 2k\pi$, where k is an integer; min value is $\frac{17}{5}$ for $x = k\pi$, where k

is an integer (b) $\frac{\pi}{3}, \frac{5\pi}{3}$ 16. (a) $u_n = 74 - 6n$ (b) $n = \frac{1}{6}(74 - p)$ (c) $\frac{1}{12}(74 - p)(68 + p)$, 420

17. (a) $P(x) = (x^2 - 2x + 2)(x + 3)$ (b) $P(x) = (x - 1 - i)(x - 1 + i)(x - 3)$

18. $\frac{24(4\sqrt{3}-3)}{39}$ 19. i. $\frac{\pi}{2}$ ii. $\frac{1}{2}$ 22. (a) $60^\circ, 109^\circ 28', 250^\circ 32', 300^\circ$ (b) i. $2\text{cosec}\theta$ ii. $\frac{\pi}{3}, \frac{2\pi}{3}$

23. (a) $z = 2 - 2i, z^2 = -8i$ (b) $-0.96 + 0.72i$ (c) $z = -2 \pm \sqrt{3}i, z = \frac{1}{2} \pm \frac{1}{2}\sqrt{3}i$ 26. $k = \frac{\pi}{4}$

27. (a) ~ 342 (b) 20 terms (c) $0 < x < 2$ (d) $\{1, 3, 8, 18, \dots\}$ (e) $u_n = 23 - 3n$ (f) \$4131.45

28. (a) $-\frac{1}{2}$ (b) 4 29. (a) 120° (b) $14\sqrt{3}$ cm² 30. (a) i. $0.3\sqrt{3}$ m ii. $0.2\sqrt{3}$ m (b) ~ 1.15 m

(c) $73^\circ 13'$ 31. (a) $\frac{\pi}{3}, \frac{4\pi}{3}$ (b) $\left\{x \mid \frac{\pi}{3} < x < \frac{4\pi}{3}\right\}$ 32. (a) 8 cm (b) $28^\circ 4'$ 33. (a) $\frac{5\pi}{6}$ (b) i. $64 + 0i$

ii. $4(\sqrt{3} - i)$ iii. $0 - 2i$ iv. $\frac{1}{64}(\sqrt{3} + i)$ v. $-128 - 128\sqrt{3}i$ 34. (a) i. $\frac{1}{32}$ ii. $\frac{1}{64}(-1 + \sqrt{3}i)$

(b) $\pm\sqrt{2}i$ or $1 \pm i$ 35. 3 36. (a) $\left\{\frac{\pi}{12}, \frac{7\pi}{12}, \frac{13\pi}{12}, \frac{19\pi}{12}\right\}$ (b) $\left(\frac{\pi}{3}, 1\right)$ 37. (a) \$77156.10

(b) $u_1 = -\sqrt{3}, u_3 = -3\sqrt{3}$ 38. (a) $f(x) = 3\cos(2x)$ (b) $\left\{\frac{7\pi}{6}\right\}$ (c) 3 39. (b) i. BP = 660 m,

PQ = 688 m 40. 216° 41. (b) 906 m 42. (a) $38^\circ 40'$ (b) 0.08004 m² (c) \$493.71 43. (a) 5

(b) i. $\frac{4}{27}$ ii. $-\frac{11\pi}{12}$ (c) $\alpha = -8$ 44. (a) $\tan \alpha = -\frac{1 + \sqrt{5}}{2}$ (b) range = $[3, 3.5]$ (c) i. 3 ii. 2

(e) domain = $[-\sqrt{3}, \sqrt{3}]$

45. (a) i. $W(4) = 19.38, P(4) = 14.82$ ii. $W(20) = 10.95, P(20) = 27.02$

iii. $W(35) = 13.45, P(35) = 23.25$ (b) Amp = 5, period = 50 weeks

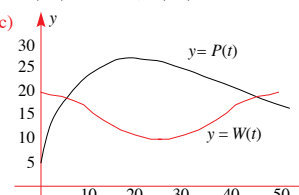
(c)  (d) \$27.07 (e) during 7th & 46th week

46. (a) \$49000, \$47900, \$46690 (b) \$34062.58

(c) 18.8 yrs (d) \sim \$248564

47. (a) ii. 26 cards (b) 26, 40, 57, 77

(c) $a = 3, b = -1$ (d) 155 cards

(e) $t_n = \frac{n}{2}(3n + 1)$

48. (a) ~ 2.77 m (b) i. 3.0 m ii. 2.0 m (c) 4.15 pm

(d) use g.c. (e) $2\frac{1}{6} < t < 6\frac{1}{3}$

49. 1.262 ha 50. $\left\{\frac{\pi}{4}, \frac{3\pi}{4}\right\}$ 51. (a) $x = -\frac{2\pi}{3}, \frac{2\pi}{3}$ (b) $-\pi$ (c) $-\frac{2\pi}{3} < x < \frac{2\pi}{3}$

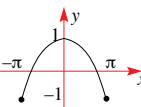

52. 1623 m 53. (a) 19.5°C (b) $D(t) = -1 + 2\cos\left(\frac{\pi}{12}t\right)$ (d) use g.c. (e) 8 am to midnight

54. 1939 m 55. (a) ii. $N_0 = 2000, \alpha = 10$ (b) 2000, 2200, 2420, 2662, 2988.2 (c) 52 hrs (d) 176995

56. (a) $(4 - \pi)$ cm² (b) $\frac{(4 - \pi)}{2}$ cm² (c) ii. $r = \frac{1}{2}$ iii. $A_n = (4 - \pi) \times \left(\frac{1}{2}\right)^{n-1}, n = 1, 2, \dots$

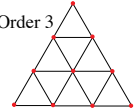
- (d) i. $\frac{31}{16}(4-\pi)$ cm² ii. $2(4-\pi)$ cm² (e) geometric **57.** (a) Order 1  Order 3 
- (b) 4 (c) Order 3: 9, Order 4: 16 & Order 5: 25 (d) n^2
 (e) Order 1: 3, Order 2: 6, Order 3: 10, Order 4: 15
 (f) $a = 1, b = 3, c = 2$ (h) Ratio tends to 0.5. This means that for large grids there are approximately twice as many small triangles as there are nodes.

REVISION EXERCISES - SET C

- 1.** (a) $\frac{1}{4}$ (b) $\frac{3}{8}$ (c) 0.3169 **2.** 0.0228 **3.** (a) 0.12 (b) 0.6087 **4.** 0.0527
- 5.** (a) $p(X = x) = \frac{\binom{5}{x} \binom{10}{5-x}}{\binom{15}{5}}, x = 0, 1, 2, 3, 4, 5$ (b) $E(X) = \frac{5}{3}, \text{var}(X) = \frac{50}{63}$ **6.** (a) 0.89 (b) $\frac{21}{40}$ (c) $\frac{40}{89}$ **7.** (a) 0.46 (b) $\frac{9}{23}$ **8.** (a) 3326400 (b) i. $\frac{2}{11}$ ii. $\frac{2}{77}$ **9.** (a) 0.9772 (b) 0.3413
- 10.** (a) 2 (b) 0.3233 **11.** (a) 0.936 (b) 5 **12.** (a) $X \sim \text{Hg}(n = 4, D = 4, N = 8)$ (b) $E(X) = 2, \text{var}(X) = \frac{4}{7}$ **13.** (a) 792 (b) 35 **14.** (a) 151200 (b) 0.1512 **15.** 0.2852 **16.** (a) 0.0067 (b)

Poisson distribution with parameter $\lambda = \frac{2}{3}$ (c) 0.5134 **17.** $\frac{128}{850} \approx 0.1506$ **18.** (a) 0.10 (b) 0.40

(c) $(x, P(X = x))$ values are: (0, 0.40), (1, 0.50), (2, 0.10) (d) $E(X) = 0.70, \text{var}(X) = 0.41$
19. (a) 0.8664 (b) 0.7210 (c) 0.9034 (d) $9.8855 < Y < 10.2145$ (e) 79.3350

20. (a) 315 (b) 17280 **21.** $\frac{193}{512}$ **22.** (a) $\frac{2}{3}$ (b) $\frac{1}{2}$ **23.** (a) $P(X = x) = \frac{1}{6} \times \left(\frac{5}{6}\right)^x, x = 0, 1, \dots$

(i.e., Geometric) (b) i. 0.0670 ii. 0.4019 iii. $\frac{1}{6}$ **24.** (a) $\frac{13}{44}$ (b) $\frac{9}{44}$

25. (b) $(x, P(X = x))$ values are: $\left(1, \frac{9}{25}\right), \left(3, \frac{7}{25}\right), \left(5, \frac{5}{25}\right), \left(10, \frac{3}{25}\right), \left(20, \frac{1}{25}\right)$

(c) $E(X) = \frac{105}{25} \approx 4.2, \text{var}(X) = \frac{11400}{625} \approx 18.24$ (d) 0.00064 **26.** (a) 0.3085 (b) 0.0091 (c) 0.1587

27. 100 **28.** (a) $\frac{1}{2}$ (b) $\frac{1}{7}$ (c) $\frac{2}{7}$ **29.** (a) 0.5940 (b) ~ 34 days **30.** (b) $(x, P(X = x))$ values

are: (1,0.4), (2,0.3), (3,0.2), (4,0.1) (c) i. 2 ii. 5 iii. 3 **31.** (a) 2, 1.35 (b) $\frac{2}{18}$ (c) Binomial

(d) $\frac{4}{3}$ (e) i. 0.38 ii. 0.390 **32.** (a) i. $\frac{3}{7}$ ii. 0.3456 (b) 4.87% (c) i. 0.8186 ii. 0.1585

33. (a) $(x, P(X = x))$ values are: $\left(0, \frac{3}{16}\right), \left(1, \frac{7}{16}\right), \left(2, \frac{5}{16}\right), \left(3, \frac{1}{16}\right)$ (b) ii. 0.0064 iii. 0.7705

(c) i. 38 ii. $\frac{1}{19}$ **34.** $\mu = 0.9586, \sigma = 0.0252$ **35.** (a) $\frac{10}{21}$ (b) i. 0.3085 ii. 0.1747 (c) i. 0.2642

ii. 0.8 **36.** (a) i. 0.8 ii. 0.25 (b) i. 0.4 ii. $E(X) = 0.8, \text{var}(X) = \frac{14}{25}$ **37.** (a) i. $\frac{1}{8}$ ii. $\frac{47}{72}$ iii. $\frac{1}{8}$

iv. $\frac{47}{72}$ v. $\frac{9}{47}$ **38.** (a) i. 0.1353 ii. 0.2707 iii. 0.8647 (b) $\frac{189}{8192} \sim 0.0231$

39. $\frac{43}{60} \approx 0.7167$ **40.** $\frac{117}{145} \approx 0.8069$ **41.** i. $(x, P(X = x))$ values are: $\left(0, \frac{1}{6}\right), \left(1, \frac{1}{3}\right), \left(2, \frac{1}{2}\right);$

$E(X) = \frac{4}{3}, \text{var}(X) = \frac{5}{9}$ ii. $\frac{2}{3}$ iii. $\frac{5}{24}$ **42.** (a) 0.0993 (b) \$2.03 per metre. If the lengths are increased, the number of faults per length would also increase, hence, the expected profit/metre would decrease (in this case it would reduce to \$1.21 per metre).

43. i. 0.4 ii. 0.096 iii. 0.225 iv. 0.635 **44.** (a) $\frac{3}{5}$ (b) $(x, P(X = x))$ values are: $\left(0, \frac{4}{25}\right),$

$\left(1, \frac{12}{25}\right), \left(2, \frac{9}{25}\right)$ (c) $E(X) = 1.2, \text{var}(X) = 0.48$ (d) $\frac{3}{7}$ **45.** (a) i. $\frac{8}{15}$ ii. $\frac{7}{15}$ iii. $\frac{1}{5}$ iv. $\frac{4}{5}$ v. $\frac{4}{7}$

(b) $\frac{x(p-q) + 100q}{100}$ **46.** $\frac{2}{3}$ **47.** (a) 0.1359 (b) 137.22 (c) $137\frac{1}{3}$ (d) $a = 141.21$ **48.** i. $\frac{2}{3}$

ii. $\frac{2}{9}$ iii. not independent **49.** i. $W = \{2, 3, 4, 5\}$ ii. $\frac{10}{3}$ iii. $\frac{17}{42}$ **50.** i. $b + 6a$ ii. $0 \leq b \leq \frac{1}{3}$

51. i. 4 ii. 0.9084 **52.** i. 0.081 ii. $\frac{4}{13}$ **53.** (a) 0.0169 (b) i. 0.9342 ii. 127 iii. 0.008

54. i. 0.1587 ii. 0.7745 iii. \$0.23 **55.** (a) i. 0.077 ii. 0.756 iii. 0.167 (b) \$7.61

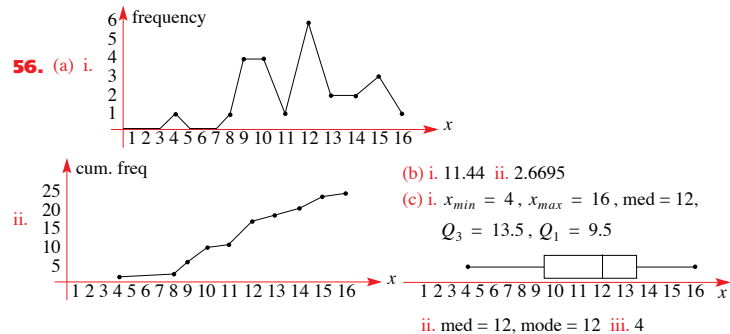

57. (a) i. 0.24 ii. 0.36 (b) $172 + 0.96Q$ (c) $Q > 29.17$

58. (a) $P(X \text{ is odd}) = e^{-\lambda} \left(\lambda + \frac{\lambda^3}{3!} + \frac{\lambda^5}{5!} + \dots \right)$ (b) $P(X \text{ is even}) = \frac{1}{2}(1 + e^{-2\lambda})$ (c) $\lambda = 1.122$

REVISION EXERCISES - SET D

1. (a) $\frac{x}{\sqrt{x^2 + 4}}$ (b) $2\cos 2x - 2(2x - 1)\sin 2x$ **2.** (a) 19.8°C (b) 1.6°C per minute (c) 17.3 min

3. (a) $x \in [-1, 0[\cup]0, \infty[$ (b) $x \in]-\infty, 0[\cup]2, \infty[$ **4.** 10 m **5.** (a) $\frac{4x}{(x^2 + 1)^2}$

(b) $-4\sin 2x \cos 2x$ (or $-2\sin 4x$) **6.** (a) i. 0 ii. 2 (b) $x \in [-2, 2]$ (c) $x \geq 0$

- (d) $-\frac{x}{\sqrt{4-x^2}}$, $-2 < x < 2$ **7.** (a) $-\frac{2+h}{(1+h)^2}$, $h \neq 0$ (b) -2 **8.** 1.455 ms^{-1} **9.** (a) Absolute maximum at $(\pm\frac{1}{\sqrt{2}}, 1)$; local min at $(0, 0)$; x-intercept at $(\pm 1, 0)$ (b) Local min at $(\pm\frac{1}{\sqrt{2}}, 1)$; asymptotes at $x = \pm 1$, $y = 0$. **10.** i. $6 \cos 2x \sin^2 2x$ ii. $\frac{x+3}{(2x+3)^{3/2}}$

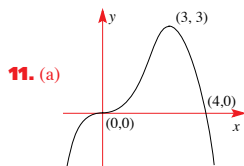

- 11.** (a) **11.** (a) 98° **12.** (b) i. 2 ii. 72 cm^3 **13.** i. $-\frac{3x}{\sqrt{1-3x^2}}$ ii. $\frac{e^x}{(1+e^x)^2}$

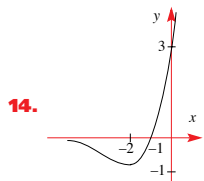

- 14.** **15.** (a) $h = \frac{1000}{\pi r^2}$ (b) radius = 5 cm, height = 12.7 cm

- 16.** (a) $3x^2h + 3xh^2 + h^3$ (b) $3x^2 + 3xh + h^2$ (c) $3x^2$ **17.** (a) $p'(t) = 0.8(1 - 0.02t)e^{-0.02t}$ (b) ~ 38.3 million (c) i. decreasing ii. ~ 0.1 million/year (d) 50 years time, i.e., 2030; 42.2 million

- 18.** 76222 cm^3 **19.** i. $\frac{1 + \cos x + x \sin x}{(1 + \cos x)^2}$ ii. $\frac{x}{x^2 + 1}$ **20.** (a) $12 + 6h + h^2$, $h \neq 0$ (b) 12

- 21.** (a) i. 283 sec ii. 250 sec (c) 244 sec **22.** $a = -1$, $b = 6$, $c = -9$ **23.** (a) $\frac{4\sqrt{3}}{3}$

- (b) i. $-6 \sin 3x \cos 3x$ ii. $\frac{x}{2} + \frac{1}{12} \sin 6x + c$ **24.** $y = x - 2$ **25.** max = 64, min = $-\frac{2187}{256}$

- 26.** i. $\frac{3 \cos x}{2\sqrt{2-3 \sin x}}$ ii. $(2 \cos \frac{1}{2}x - \frac{1}{2} \sin 2x)e^{2x}$ iii. $\frac{1 - \ln x}{x^2}$, $x > 0$ **27.** (a) $V = \pi r^2 h + \frac{4}{3} \pi r^3$

- (b) $P = 2\pi k r h + 6\pi k r^2$ (c) $P = \frac{2kV}{r} + \frac{10\pi}{3} k r^2$ (d) $0 < r < (\frac{3V}{4\pi})^{1/3}$ (e) $r = (\frac{3V}{10\pi})^{1/3}$

- 28.** (b) $[\frac{a}{4}, \frac{a}{2}]$ (c) $\frac{\sqrt{3}}{36} a^3$ cubic units **30.** i. $-6 \sin 2x \cos^2 2x$ ii. $\frac{1-2x^2}{\sqrt{1-x^2}}$ **31.** $y = -\frac{1}{2}x + 2$

- 32.** 0.5 cm s^{-1} **33.** (a) $[0, 5]$ (b) use g.c (c) 0.625 (d) $a = \frac{1}{2} - \frac{1}{5}t$, $0 \leq t \leq 5$

- 34.** (c) Minimum, $3\pi a^2 (\frac{5}{3})^{1/3}$; Maximum $3\pi a^2 (\frac{9}{4})^{1/3}$ **35.** (a) $-e^{-x}(\cos x + \sin x)$ (b) 1

- 36.** i. $V = \frac{4}{27} \pi h^3$ ii. 64 sec iii. falling at 1.15 cm min^{-1} **37.** (a) $x < \frac{1}{2}$ or $x > \frac{1}{2}$

- (b) $-\frac{1}{2} < x < 0$ or $0 < x < \frac{1}{2}$ **38.** $\frac{4}{3}$ **39.** (b) i. $AB = 200 \tan \theta$ ii. $20 \sec^2 \theta$ iii. Point A iv. yes

- 40.** (a) $\sin^{-1}(x) + \frac{x}{\sqrt{1-x^2}}$ (b) $y' = \frac{2x^2 - \ln(x^2 + 1)}{x^2(x^2 + 1)}$ **41.** (a) $(0, \frac{9}{2})$ (b) $y = 4 - x$ and $x = 2$

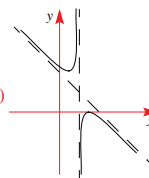

- (c) (1, 4) & (3, 0) (d) **42.** (a) $\frac{12-8x^2}{(2x^2+3)^2}$ (b) $\frac{8}{9}\sqrt{3}$ **43.** (a) $y = \frac{\sqrt{3}}{2}x + 1$,

- $y = -\frac{\sqrt{3}}{2}x + 1$ (b) $(2\sqrt{3}, 4)$ & $(-2\sqrt{3}, 4)$ **44.** (a) i.  ii. f is not a one-one

- function (b) $c = -2$ (c) i. $f \circ g(x) = -2|\sin x|$, range = $[-2, 0]$, domain = \mathbb{R} ii. $\mathbb{R} - \{n\pi, n \in \mathbb{Z}\}$

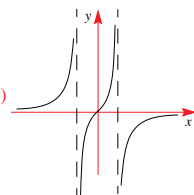
- 45.** 0.16 rad per sec **46.** $y = e^{-1}x$ **47.** (a) $x = 1$, $x = -1$, $y = 0$ (c) 

- 48.** (a) $(4 \sin 2x - 3 \cos 2x) \cdot e^{-x}$ (b) $\frac{2-3x^2}{x^2\sqrt{(1-x^2)^3}} + \frac{2\cos^{-1}x}{x^2}$

- 49.** (a) $y = (3 \ln 3)x + 3 - 3 \ln 3$ (b) $y = \frac{1}{\ln 2}(x + 1)$

- 50.** dom = $\{x | x < -4\} \cup \{x | -4 < x < 0\} \cup \{x | x > 0\}$ **51.** $\sim 2.77 \text{ km h}^{-1}$ **52.** $\frac{1}{25\pi} \text{ ms}^{-1}$

- 53.** 2.83 ms^{-1} **54.** (a) 27 sec (b) 746 m **55.** (a) $A = 318 - 6x - \frac{1176}{x^2}$, $4 \leq x \leq 49$

- (b) $x = 14$, $y = 21$ **56.** (a) $a = \frac{4}{3}$, $b = -1$, $c = 4$ **57.** (a) i. $0 \leq x \leq \frac{1}{3}L$ (b) i. $x = \frac{3L}{\sqrt{3\pi} + 9}$

- ii. local min. iii. use a graphics. calc. (c) i. $x = \frac{3L}{\sqrt{3\pi} + 9}$ ii. $x = 0$ **58.** (a) i. $\frac{2x}{(x^2 + 1)^2}$

- ii. $-\frac{66}{(3x+2)^3}$ (b) $(20 \log_e 5)y = -x + 1 + 400 \log_e 5$ (c) $\frac{1}{\ln 2}$ (d) $1.5 \ln 2 \text{ ms}^{-1}$

- 59.** (a) $a = 8$, $b = \frac{2\pi}{11}$ (b)  (c) $-\frac{6\pi}{11} \sin(\frac{2\pi}{11}t)$, some values will be

- negative indicating that the tide is going out. (d) $-8 \sin(\frac{2\pi}{11}t)$

- 60.** (b) $k = 250$ (c) $I = 250 \sin \theta [2 \cos^2 \theta - \sin^2 \theta]$ (d) 212 m (e) 96.23 (f) ii. ~ -0.68
61. 0.032 rad per sec

REVISION EXERCISES - SET E

1. (a) i. $\frac{91}{3} + \ln 4$ ii. $\frac{4}{15}(1 + \sqrt{2})$ (b) i. $-2\sqrt{1-x^2} + c$ ii. $\frac{1}{3} \tan^{-1}\left(\frac{4x}{3}\right) + c$ iii. $\frac{1}{2} \sin^{-1}(2x) + c$

2. (a) $N = ke^t + 2, N > 2$ (b) 3 m (c) $y = \tan\left(t - \frac{\pi}{4}\right)$ **3.** $v = 2 - \sqrt{t+1}, t \geq 0$

4. (a) $-7i + 6j + k$ (b) -8 (c) $a = \frac{1}{\sqrt{3}}(i + j + k)$ **5.** (a) $\frac{1}{48}$ (b) $\frac{\pi}{3}$ (c) 2

6. (b) i. $\pi \int_0^{0.5} 4y^2 dy + \pi \int_{0.5}^1 \left(\frac{1}{y} - 1\right) dy$ ii. 1.13 cubic units **7.** 327 cm **8.** $\frac{dm}{dt} = -\frac{7m}{100 + 3t}$

9. (a) $4x - y - 4z = -2$ (b) $-x + 7y + 19z = 42$ (c) (10, 10, 3) **10.** (a) $\frac{\pi}{3}, \frac{4\pi}{3}$

(b) $\left\{x \mid \frac{\pi}{3} < x < \frac{4\pi}{3}\right\}$ (c) 4 sq. units **11.** 720 m³ **12.** (a) i. $x = \frac{7}{2} + \lambda, y = \lambda, z = \frac{9}{2} + \lambda, \lambda \in \mathbb{R}$

ii. $\frac{x-3.5}{1} = \frac{y}{1} = \frac{z-4.5}{5}$ (b) i. $(-5, 3, 2)$ ii. (8, 11, 0) (c) $2x + 5y - z = -8$ **13.** $a = 1, b = 6$

14. 0 **15.** (a) $-8i + 11j + 9k$ (b) $a = -\frac{2}{5}, b = \frac{4}{5}$ (c) $5\sqrt{3}$ sq. units

16. (a) Area = $A = \frac{8}{15}h^{3/2}$, Volume = $V = 0.48h^{3/2}$ (b) $\frac{5}{144}$ m/min **17.** (a) $(-1, 4), (1, -2), (3, 0)$ (b) use g.c (c) $\frac{16}{3} - 3 \log_e 3$ sq. units **18.** (a) $2 - \frac{3}{4}\sqrt{3}$ (b) $\log_e 3$ **19.** (a) $A \equiv (2e, 2e^{-1})$

(b) i. $y = x$ ii. $\frac{d}{dx}(xe^{-x/k}) = \left(1 - \frac{x}{2}\right)e^{-x/2}$ iii. $4 - 2(2+a)e^{-a/2} - \frac{1}{2}a^2$ (c) i. $(2x - x^2)e^{-x}$

ii. $\pi(2 - 10e^{-2})$ cubic units **20.** (a) $f(x) = \frac{1}{5}(2x-1)^{5/2} + \frac{1}{3}(2x-1)^{3/2} + c$ (b) i. $\frac{\pi}{12}, \frac{\pi}{48}$

ii. $\frac{1}{9}$ (c) i. use g.c. ii. $\frac{\pi}{3}$ sq. units iii. $\frac{\pi}{2} \ln 3$ cubic units **21.** $k = 1$ or 3 **22.** $t = 2, (16, -8, 4)$

23. (a) i. $x = \frac{3}{k-3}, y = \frac{8-k}{k-3}, z = \frac{k-5}{k-3}$ ii. $k \neq -2, 3$ (b) $k = 3$ (c) i. $k = -2$ ii. $x = 2 - \lambda,$

$y = -2, z = \lambda, \lambda \in \mathbb{R}$ **24.** $A^2 = I_{3 \times 3}; (-1, -3, 4)$ **25.** $BX = \frac{1}{2}A, X = \frac{1}{18}BA,$

$AX = \frac{1}{18}ABA$ **26.** (a) $A \equiv \left(\frac{1}{2} \ln 2, 2(1 - \ln 2)\right)$ (b) $\frac{1}{2}(e^2 - 5)$ sq. units

(c) i. At (0,1): $y = -2x + 1$ At $(1, e^2 - 4)$: $y = (2e^2 - 4)x - e^2$

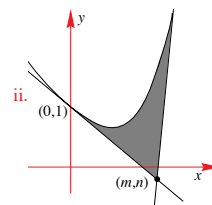

ii. $\frac{1}{2}(e^2 - 5)$ sq. units (d) ii. $\frac{\pi}{12}(3e^4 - 24e^2 + 37)$ cubic units

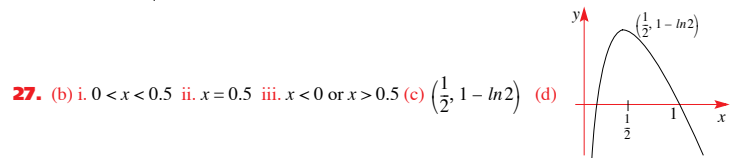

27. (b) i. $0 < x < 0.5$ ii. $x = 0.5$ iii. $x < 0$ or $x > 0.5$ (c) $\left(\frac{1}{2}, 1 - \ln 2\right)$ (d)

(e) i. $y = -x + 1$ ii. $y = x - 1$ (f) i. $\frac{3}{8} - \frac{1}{2} \ln 2$ sq. units ii. $\frac{1}{8} + \frac{1}{2} \ln 2$ sq. units **28.** $A = 0, B = 0.5$

29. (a) $\frac{7}{12}$ sq. u (b) $\frac{7}{15}\pi$ cubic units **30.** (a) $a = 2; f^{-1}(x) = 2 + \sqrt{x}, x \geq 0$

(b) $\frac{136}{3}\pi$ cubic units **31.** (a) $y = -ex + e + e^{-1}$ (b) $\frac{1}{2}e + e^{-2}$ sq. units

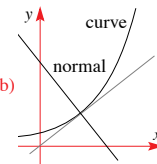

32. (a) $\frac{4}{3}$ sq. units (b) $\frac{64}{15}\pi$ cubic units **33.** (a) $x = \frac{1}{3}[20 - 14e^{-0.1t}]$ (b) 19 minutes

34. $\frac{\tan^{-1}\sqrt{x}}{2\sqrt{2}} + \frac{1}{2} \cdot \frac{1}{1+x}, 2\sqrt{3}\pi - \frac{\pi}{2} - \ln 2$ **35.** (a) $\frac{dh}{dt} = \frac{V - k\sqrt{h}}{\pi h^2}$ (b) $\left(\frac{V}{k}\right)^2$ m

36. (a) $3i - j - 2k$ (b) 100° (c) $4i - 3j - 3k$ **37.** (b) $A^{-1} = \frac{1}{3}(A - 2I)$

38. (a) $1 - \frac{x}{\sqrt{1-x^2}} \cdot \sin^{-1}x, \frac{\sqrt{3}}{2} - \frac{\pi}{6}$ (b) i. $\frac{2}{5}(1-x)^{5/2} - \frac{2}{3}(1-x)^{3/2} + c$ ii. $e^x - \ln(e^x + 1) + c$

(c) $\frac{1}{3} \ln 2$ **39.** $\frac{64}{15}\pi$ cubic units **40.** (a) $2\sqrt{2}$ (b) $t = 5, b = 0.4$

41. (a) $\frac{dx}{dt} = \frac{50-x}{10}, t = 0, x = 6$ (b) 0.32 kg per litre **42.** (a) $\frac{1}{a-2} \begin{bmatrix} -3 \\ 2a-1 \end{bmatrix}$ (b) $a = 2$

(c) $x = -3, y = 5$ **43.** (a) $a = 1$ (b) 1.25 (c) $\frac{13}{48}$ (d) $\frac{19}{64}$ **44.** (a) i. 90° ii. $\frac{7}{2}\sqrt{26}$ unit²

(b) i. $s + 3p$ ii. $s + 2p$ iii. $\frac{1}{2}s + 2p$ iv. $-\frac{1}{2}s + 2p$ **45.** (a) 1 (b) $A^n = \begin{bmatrix} 2^n & (2^n - 1)a \\ 0 & 1 \end{bmatrix}$

(c) $a = -\frac{2}{9}$ **46.** (a) 27° (b) $\frac{1}{2}\sqrt{17}$ unit² **47.** (a) i. $\begin{pmatrix} x \\ y \end{pmatrix} = \begin{pmatrix} 2 \\ -3 \end{pmatrix} + \lambda \begin{pmatrix} 3 \\ 7 \end{pmatrix}, \lambda \in \mathbb{R}$

ii. $x = 2 + 3\lambda, y = -3 + 7\lambda, \lambda \in \mathbb{R}$ iii. $\frac{x-2}{3} = \frac{y+3}{7}$ (b) $-i + 11j$ (c) i. no ii. lines are skew

48. (a) i. $2x + 3y - 4z = 2$ ii. 90° (b) i. $28^\circ 35'$ ii. $32^\circ 25'$ **49.** $(-8, 11, -6)$ **50.** (a) $a = \frac{3}{2}$

(b) $b = \frac{3}{2}, c = \frac{1}{3}$ **51.** $\begin{pmatrix} x \\ y \\ z \end{pmatrix} = \begin{pmatrix} 0 \\ 10 \\ 3 \end{pmatrix} + \lambda \begin{pmatrix} 1 \\ -19 \\ -5 \end{pmatrix}$ **52.** (a) $\hat{c} = \frac{1}{\sqrt{77}}(-5i + 4j + 6k)$

(c) $2x + y + 3z = 4$ **53.** $k = -1, 1$ or 2 **54.** (a) i. $\begin{bmatrix} 2 \\ 5 \end{bmatrix}$ ii. $\frac{1}{2} \begin{bmatrix} 1 & 0 \\ 2 & 2 \end{bmatrix}$

(b) $x + y - z = 1, 3x + 4y + 6z = 7$ (c) $\begin{pmatrix} x \\ y \\ z \end{pmatrix} = \begin{pmatrix} -3 \\ 4 \\ 0 \end{pmatrix} + \lambda \begin{pmatrix} 10 \\ -9 \\ 1 \end{pmatrix}$ **55.** (a) i. $\frac{\pi}{2}$ ii. $2\pi - 4$

(b) $\frac{\pi^2}{2} + \pi$ cubic units (c) i. $y = -x + 2$ ii. $\frac{3}{2} - e^{-1}$ sq. units **56.** (a) see page 362

(b) $\frac{\pi\sqrt{3}}{3} + \ln \frac{1}{2}$ sq. units **57.** (b) i. $a = \sqrt{3}$ ii. $b = \frac{1}{6}$ **58.** $\frac{\pi}{2}(e^2 - e^{-2})$ cubic units

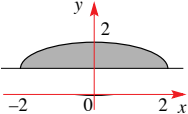
59. (a)  (b) $2\pi^2 + \frac{8\pi}{3}$ cubic units **60.** (a) 5 (b) $\frac{5}{3}\sqrt{5}$ **61.** (b) 76 sec

62. $I_1 \sqrt{I_2}$ **63.** (a) i. $a = 3, b = -2$ ii. $a = \frac{1}{3}(2\lambda - 1), b = \lambda, \lambda \in \mathbb{R}$ (b) $(-12, -10, -2)$

(c) i. $\frac{1}{2}\sqrt{629}$ ii. $x - 12y + 22z = 0$ iii. $r = \lambda \begin{pmatrix} 1 \\ -12 \\ 22 \end{pmatrix}$ **64.** (a) i. $\frac{1}{2}(x^2 + 1)\arctan x - \frac{1}{2}x + c$

ii. $x \cdot \arcsin x + \sqrt{1 - x^2} + c$ (b) i. $\frac{1}{4}[(1 - 2a^2)\cos 2a + 2\sin 2a - 1]$ ii. $\frac{5}{27}e^3 - \frac{2}{27}$

65. (a) $t = 1$ & $t = 5$. ii. use a g.c. (b) $t = 2.21$ **66.** 40.5°C

Note: A Solutions Manual – which includes fully worked solutions to most questions in the textbook is also available. Check the ibid press website for updates and availability.

www.ibid.com.au

or contact fabio@ibid.com.au